

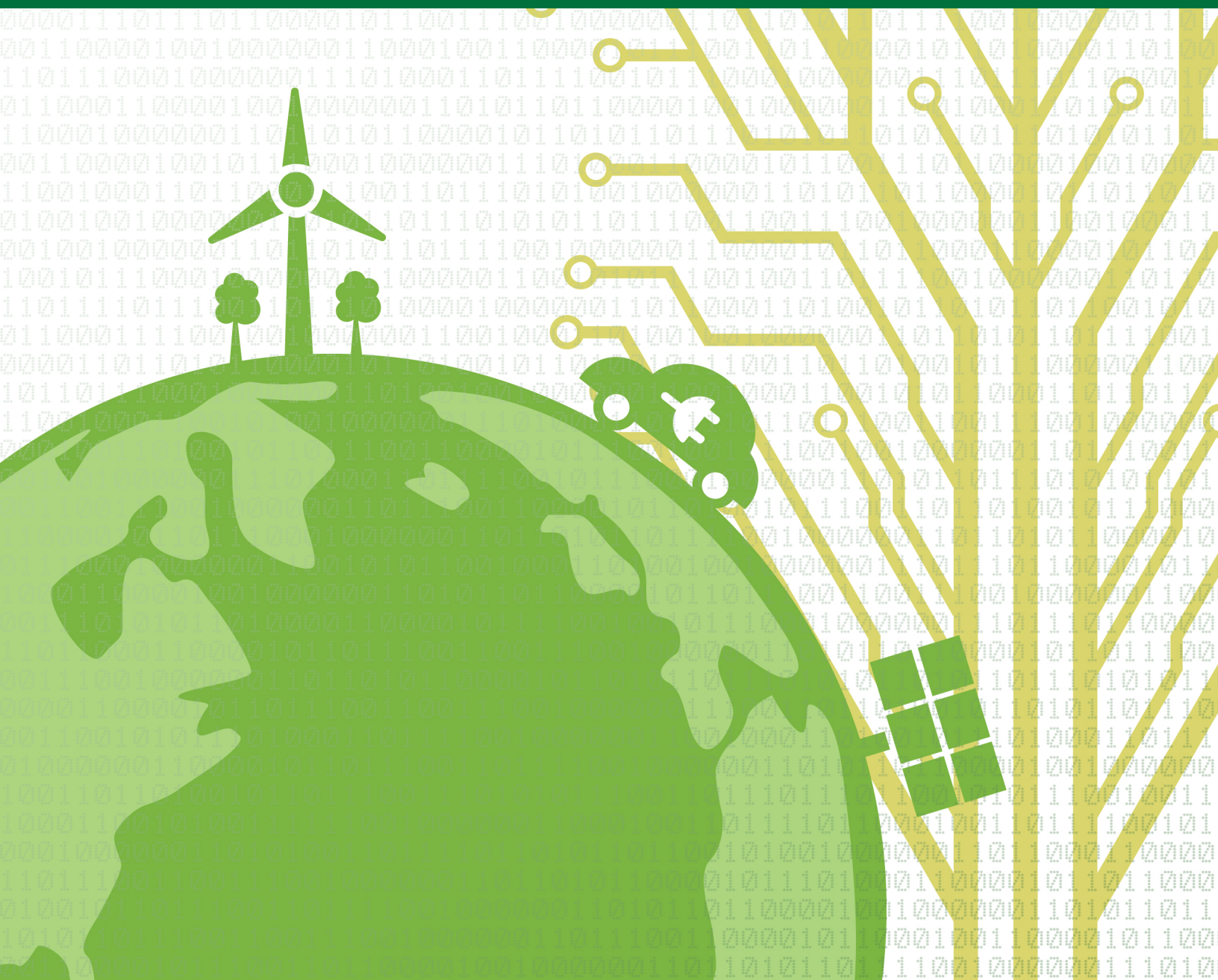

Journal of Computational Innovations and Engineering Applications

Vol.1 No. 1

July 2016



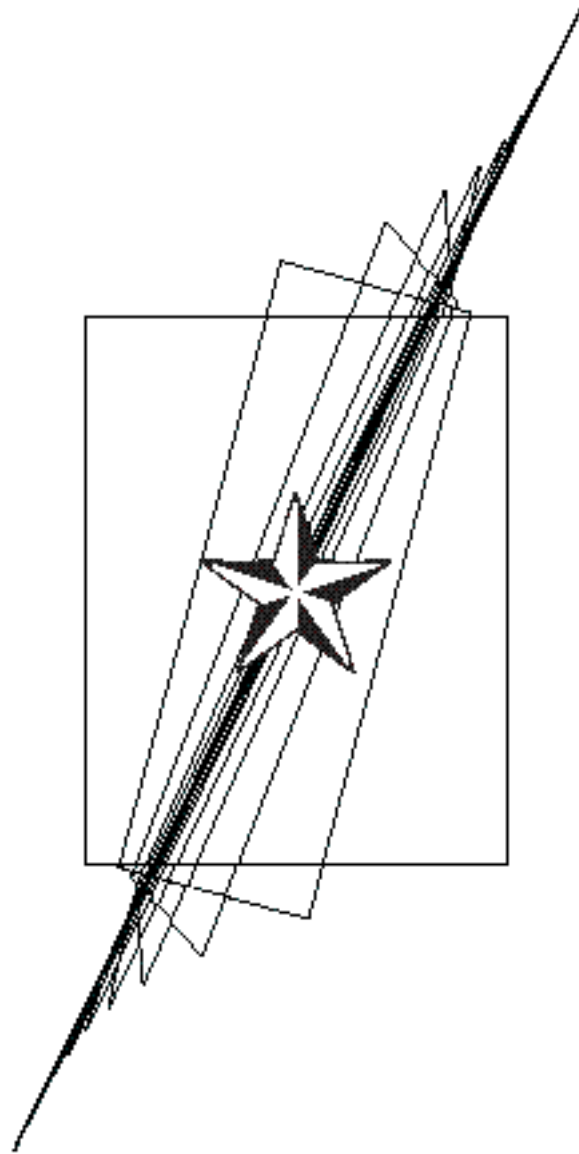

**JOURNAL OF
COMPUTATIONAL INNOVATIONS
AND ENGINEERING APPLICATIONS**

Volume 1 Number 1 July 2016

The **Journal of Computational Innovations and Engineering Applications (JCIEA)** is a peer-reviewed, open access journal of De La Salle University, Manila. The JCIEA aims to promote the development of new and creative ideas on the use of technology in solving different problems in different fields of our daily lives. The JCIEA solicits high quality papers containing original contributions in all areas of theory and applications of Engineering and Computing including but not limited to: Computational Applications, Computational Intelligence, Electronics and Information and Communications Technology (ICT), Manufacturing Engineering, Energy and Environment, Robotics, Control and Automation, and all their related fields. The JCIEA editorial board is comprised of experts from around the world who are proactively pushing for the development of research in these fields.

Annual Subscription Rates: Foreign libraries and institutions: US\$60 (airmail). Individuals: US\$50 (airmail). Philippine domestic subscription rates for libraries and institutions: Php1,800, individuals: Php1,300. Please contact Ms. Joanne Castañares for subscription details: telefax: (632) 523-4281, e-mail: dlsupublishinghouse@dlsu.edu.ph

Copyright © 2016 by De La Salle University

All rights reserved. No part of this publication may be reproduced, stored in a retrieval system, or transmitted in any form or by any means—electronic, mechanical, photocopying, recording, or otherwise—without written permission from the copyright owner.

ISSN 2507-9174

Published by De La Salle University Publishing House
2401 Taft Avenue, Manila 0922 Philippines
Telephone: (63 2) 523-4281 / 524-2611 loc 271
Fax: (63 2) 523-4281
Email: dlsupublishinghouse@dlsu.edu.ph
Website: <http://www.dlsu.edu.ph/offices/publishing-house/journals.asp>

The De La Salle University Publishing House is the publications office of De La Salle University, Manila, Philippines.

JOURNAL OF COMPUTATIONAL INNOVATIONS AND ENGINEERING APPLICATIONS

TABLE OF CONTENTS

EDITOR'S NOTES

ARTICLES

Gender-Based Violence in Nigeria: A Cross-Sectional Study of the Magnitude, Likely Risk Factors, and Attitudes Towards Intimate Partner Violence Against Women <i>Lateef Olayanju, Raouf Naguib, Saad Amin, Quynh Nguyen, Olabode Kayode, Oluseye Olayanju, and Gil Nonato Santos</i>	1
Application of Genetic Algorithm and Wavelet Transform in Eye-blink Detection from Electroencephalograms <i>Roy Francis Navea and Elmer Dadios</i>	17
Hybrid Fuzzy Multi-criteria Decision Making: Exploring Decisive Green Purchasing in Customer Relationship Management <i>Chun-mei Su, Der-Juinn Horng, Ming-Lang Tseng, and Anthony SF Chiu</i>	26
A Novel Consensus-seeking Approach in a Group Decision Making Environment <i>Michael Angelo B. Promentilla</i>	44
Design of an All-MOS Temperature Sensor with an 8-bit Incremental Delta-Sigma ADC on a 0.18 μ m Technology <i>Juan Gabriel Briones, Gino Marasigan, Jan Bryan Pascasio, Rachel Marie Dalisay, Joseph Ponce, Donato David, and Alexander Abad</i>	55
Implementation of a Vertical Take-off and Landing for DC Motor-based Rotorcraft <i>Elmer Magsino, Mark Lorenze Torregoza, and Elmer Dadios</i>	65
WebSurge: A Profile-based Stress Testing Tool with Distributed User Agents for Web Applications <i>Michael de la Cruz, Jeyran Labrador, and Dante Dinawanao</i>	75
Hydrodynamic Analysis of the ACCORDION Photobioreactor for Microalgae Cultivation using Computational Dynamics Analysis <i>Andres Philip Mayol, Aristotle Ubando, Joel Cuello, and Alvin B. Culaba</i>	85
Multiple Face Detection and Recognition Using HSV Histogram Matching and Principal Component Analysis Techniques <i>Alberto Bañacia, Mark Bryan Soylon, Sean Chris Conson, Jonn Dennis Regidor, and Florencio Cortes</i>	90

FROM THE EDITOR

The Journal of Computational Innovations and Engineering Applications (JCIEA) is a peer-reviewed and abstracted journal published twice a year by De La Salle University, Manila, Philippines. JCIEA aims to promote and facilitate the dissemination of quality research outputs that can push for the growth of the nation's research productivity.

In this first JCIEA issue, 9 articles are selected, which will provide valuable references for researchers and practitioners.

The first article is Gender-Based Violence in Nigeria: A Cross-Sectional Study of the Magnitude, Likely Risk Factors and Attitudes Towards Intimate Partner Violence Against Women. This paper focuses on serious public health problem that comes with a debilitating toll on women, their families, and the immediate environment in which they reside. The second article covers the algorithm for detecting eye-blink artifacts in an electroencephalogram (EEG) signal using optimized wavelets. The third article discusses the impact of customer relationship management (CRM) on customer purchase intention related to green products from the perspective of firms in Taiwan's food industry. Due to increasing awareness of environmental effects, customers are more sensitive towards green products when making purchase decisions. The fourth article is A Novel Consensus-Seeking Approach in a Group Decision Making Environment. In here, the group consensus index is a weighted consensus that incorporates the individual's influence on a group decision while evaluating the compatibility or closeness of ratio-scale vectors between the individual and the group-aggregated priorities.

The fifth article is on the design and characterization of a temperature sensor with an 8-bit low-voltage incremental delta-sigma analog-to-digital converter (ADC). The proportional to absolute temperature (PTAT) part of an All-MOS band gap voltage reference is utilized as the temperature sensor. The sixth article shows the implementation of a vertical take-off and landing for DC motor-based rotorcraft. Unlike most models, a load disturbance is not equally shared by DC motors. Instead, each motor carries the actual weight. A fuzzy logic controller is used to determine the necessary individual motor speed to attain the vertical take-off height. The seventh article deals with WebSurge, a profile-based stress-testing tool with distributed user agents for web applications. In this study, two web applications were subjected to a stress test using WebSurge to test its functionality. Meanwhile, the eighth article covers a hydrodynamic analysis of the ACCORDION photo-bioreactor for microalgae cultivation using computational dynamics analysis. Microalgae are microorganisms that have promise in the biotechnology and energy sector. The final

article is on multiple face detection and recognition using HSV histogram matching and principal component analysis techniques.

The JCIEA editorial board expresses their warmest thanks and deepest gratitude to the distinguished authors for their outstanding contribution to this first issue. They likewise express profound appreciation to the reviewers for their assistance and cooperation.

Original research outputs are most welcome to JCIEA. There is no publication fee in this journal, and the research papers are assured of fair and fast peer review process. For further information, please visit www.dlsu.edu.ph/offices/publishing-house/journals.asp.

Prof. Elmer P. Dadios, Ph.D.
Editor-in-Chief, JCIEA

Gender-Based Violence in Nigeria: A Cross-Sectional Study of the Magnitude, Likely Risk Factors, and Attitudes Towards Intimate Partner Violence Against Women

Lateef Olayanju, Raouf Naguib, Saad Amin, Quynh Nguyen, Olabode Kayode
Oluseye Olayanju, and Gil Nonato Santos

Abstract—Globally, a common manifestation of gender-based abuse is intimate partner violence (IPV) against women. IPV is a serious public health problem that comes with a debilitating toll on women, their families, and the immediate environment in which they reside. Research, mostly conducted in developed countries, has identified some likely factors responsible for violence and has also explored attitudes that could be supportive of abuse. However, developing countries around the world, especially those in Africa, are still far behind in making tangible impact on exploring these issues. Considering this paucity of information and with the aim of contributing to the IPV knowledge base in the developing world, a cross-sectional population-based survey involving 719 Nigerian women (aged 18 years and above, currently or previously in cohabiting or non-cohabiting relationships) was conducted using a detailed pretested questionnaire to solicit data on demographics, socioeconomic, attitudinal, and behavioral characteristics, as well as those pertaining to experiences of IPV. On performing relevant descriptive statistical analyses on the data collected, the results show that lifetime and current prevalence of IPV are 25.5% and 16.7%,

respectively. There is also an indication that women across urban and rural areas have a relatively high level of acceptance towards IPV (wife-beating). Results from logistic regression analysis to identify the predictors of violence show that factors such as women's and partners' educational attainments, partnership age and educational disparities, partnership discord, among others, are predictive of violence.

Index Terms—Domestic violence, women, prevalence, risk factors, attitudes.

I. INTRODUCTION

INTIMATE partner violence (IPV), a form of gender-based violence (GBV), is a serious issue that is endemic in virtually all societies in the world, cutting across social class, race, age and religious affiliations [1]. Although it is a problem that affects both men and women, overwhelming majority of victims are women [2], [3]. Nonetheless, issues surrounding IPV against women are not only women's issues as the name connotes, they are also pertinent to standard of general public health, attainment of human rights, and they are issues predisposing societies to poverty as well as stifling economic growth and development [3], [4], [5]. IPV occurs in intimate relationships and affects about one in every three women across the globe [6]. But in developing countries, especially in Africa where societies are already ravaged by a host of social and health issues, IPV imposes an additional burden, with research showing prevalence of IPV against women that is as high as 80% [7]. In addition to being a social concern in its own right, IPV also predisposes people

L. O. Olayanju is with the Royal Wolverhampton NHS Trust, UK and BIOCORE Research & Consultancy International, UK.

R. N. G. Naguib is with the BIOCORE Research & Consultancy International, UK and Liverpool Hope University, UK.

S. Amin is with the Faculty of Engineering & Computing, Coventry University, UK.

Q. T. Nguyen is with the BIOCORE Research & Consultancy International, UK.

O. Kayode is with the Department of Epidemiology and Community Health, University of Ilorin, Nigeria.

O. A. Olayanju is with Silver Ivory Africa Ltd., Nigeria.

G. N. Santos is with the Physics Department, De La Salle University, Manila, Philippines

to a range of adverse health outcomes, including infectious diseases such as HIV/AIDS, syphilis, and dangerous life-style choices such as substance abuse [3], [8].

Studies have explored some of the likely factors responsible for IPV occurrence, and results have consistently shown that demographic factors such as age, education, socioeconomic status, among others, are inversely associated with IPV [9], [10], [11]. Findings from behavioral and socio-cultural studies show significant associations with incidence of IPV, particularly in traditional environments where there are weak community sanctions and low proportions of female literacy [6], [12], [13], [14].

Studies carried out in developed countries have underscored the emergence of IPV as strongly related to socioeconomic factors, and also showed the links between IPV and adverse health outcomes as well as economic costs. However, the same cannot be said of developing countries such as Africa. Legislative support to bring about the desired protection for women, in particular, is either lacking or poorly developed [15], [16].

WHO [3] cautioned that predictors of IPV vary among countries; as such it may be erroneous and inexpedient for developing countries to transfer ideas directly from developed ones. Guidelines for policies and decisions should be country-specific. It can be justified therefore that, elaborate research is needed urgently in the developing world to address these issues.

The purpose of this paper is to study the magnitude of IPV against women in a developing country (Nigeria) and explore the attitude of women towards abuse. The paper also aims to identify and discuss specific socio-behavioral factors which can predict incidents of IPV in a developing environment such as the country in question.

II. METHODS

A. Study Design

To achieve the purpose of this study, a cross-sectional population-based household survey involving 719 women was carried out in Kwara State. The critical inclusion criterion was: women aged 18 years and above who were previously or currently involved in a cohabiting or non-cohabiting relationship. A

multistage sampling procedure which reflected the rural and urban locations of the respondents was adopted. First, randomly selected Wards were identified; then Enumerated Areas of smaller clusters of people; and thirdly, households where only one eligible woman per household, were identified by a systematic random sampling method.

The selected study area—Kwara State—is one of the 36 member States constituting Nigeria. It is located in the middle-belt geo-political region and serves as gateway between the northern and southern parts of Nigeria. The socio-demographic profile of the State is diverse in ethnicity, socioeconomic and sociocultural practices, thereby making it suitable for the study.

B. Questionnaire and Data Collection

Eight primary sections were created for the questionnaire. Closed structured questions were pretested and used in the training of selected data collectors and research assistants. Data on respondents' socio-demographic identity, general health status, including reproductive status, were obtained through voluntary opinion. Specific data on current and past dates or sexual partners were included. Attitudes towards gender roles and violence, partners' controlling behavior, experiences, and consequences of violence in the relationship were central to the questions. The design of the questionnaire drew on the experience of recent work by the WHO—Multi-country Study on domestic violence against women [8] and ICRW—Study on the cost of domestic violence [17].

To capture the experience of IPV, behavior-specific questions pertaining to the different forms of IPV (i.e., physical, sexual, and psychological) were used and responses to the questions were coded on a binary scale (i.e., Yes or No). Table I contains a sample of these questions. The questions and approach were chosen to encourage better disclosure of violence experience and facilitate reasonable comparison with other studies. Ultimately, this choice was made to help draw meaningful conclusions from the research results.

To estimate the prevalence and document attitudes towards IPV as well as determine which risk factors are predictive of experience of violence, a statistical software package (IBM SPSS Statistics 20) was used

to explore the data generated. Strict adherence to the standard ethical guidelines designed by the WHO for Research on Domestic Violence against girls, children, and women [1] were upheld throughout the study. Approval for the study was sought and obtained from the Ministry of Women Affairs, Kwara State.

III. DATA ANALYSIS

IBM SPSS statistical software was used to automatically estimate the magnitude—lifetime and current prevalence—of any form of IPV (i.e., physical, psychological, and/or sexual violence), and also for each of the specific forms of IPV covered in the study. The process involved in the calculation is the division of the number of women reporting victimization by those in the sample. The descriptive analysis also generated frequency tables to examine how socio-demographic factors—age, area of residence, educational attainment, literacy, employment status—affect the observed prevalence of IPV. In other words, it explores the distribution of IPV occurrence with the different socio-demographic factors.

To explore women's attitudes towards IPV (specifically, their degree of acceptance of wife-beating), descriptive statistics were also used to assess the respondents' opinions on the following questions that were solicited as part of the survey: "In your opinion, does a man have a good reason to hit his wife if: (a) she does not complete her household work to his satisfaction, (b) she disobeys him, (c) she refuses to have sexual relations with him, (d) she asks him whether he has other girlfriends, (e) he suspects that she is unfaithful and (f) he finds out that she has been unfaithful."

In addition to facilitating the exploration of attitudes towards gender roles in Nigeria, this set of questions was chosen to make the results of this study comparable to those of others as these questions and very similar ones are widely used for such assessments (See [8], [14], [18], [19]).

In the analysis process of this study, a binary variable amenable to simple descriptive statistics was created from the questions—with one of the categories of the variable signifying acceptance of wife-beating (in cases where respondents agreed with at least one of the instances above that justified

wife-beating), while the other category signifies non-acceptance of wife-beating (in cases where respondents did not agree with any of the instances, or stated that they do not have a particular opinion). Moreover, the rationale behind forming the non-acceptance of wife-beating category by grouping respondents that did not agree with any of the instances and those who stated that they do not have a particular opinion is mainly to ensure comparability of results with those of other studies. The variations in acceptance/non-acceptance of wife-beating with demographic variables were also catalogued using a frequency table and inferentially explored via Chi-square test.

For the risk factors analysis aspect of the study, simple bivariate logistic regression was first performed to study the crude association between each of the independent variables and the occurrence of IPV. The independent variables explored include: woman's characteristics (age, literacy, educational attainment, employment, partnership status, categorical number of children, rural/urban residence, and frequency of communication with her family), partner's characteristics (age, literacy, educational attainment, employment, general history of physical aggression, affairs with other women, alcohol use, history of drug use, and controlling behaviors), as well as relationship characteristics (age difference, employment and educational disparity, payment of dowry/bride price, discord, and choice of partner). After inspection of the simple regression analysis results, potential variables for the multivariable analysis were selected using a significance criterion of $p < 0.05$. Drawing on the experience of relevant literature, in addition to the selected variables, some other independent variables were also selected for inclusion in the multivariable analysis based on prior knowledge of them being major contributors towards IPV.

Sequential logistic regression was used in the multivariable analysis to find the best fitting, most parsimonious, and biologically reasonable models to describe the association between the sets of individual- and relationship-level variables and the occurrence of IPV. As the name implies, the analysis was executed in stages. The first stage included all the variables that were statistically significant in the simple logistic regression, followed, in subsequent

TABLE I
OPERATIONAL DEFINITION OF THE CONCEPT OF IPV USING BEHAVIOR-SPECIFIC QUESTIONS (ADAPTED FROM [8])

Form of violence	Behavior-specific question
Physical	Has he or any other partner ever: Slapped you or thrown something at you that could hurt you? Pushed you or shoved you? Hit you with his fist or with something else that could hurt you? Kicked, dragged or beaten you up? Chocked or burnt you on purpose? Threatened to use or actually used a gun, knife or other weapon against you?
Sexual	Has he or any other partner ever physically forced you to have sexual intercourse when you did not want to? Did you ever have sexual intercourse that was not physically forced on you but because you were afraid of what he might do? Did he ever force you to perform a sex act that you found degrading or humiliating? Did he ever deny you from any sexual activity when you particularly wanted it?
Psychological	Has he or any other partner ever: Insulted you or made you feel bad about yourself? Belittled or humiliated you in front of other people? Did things to scare or intimidate you on purpose (e.g. by the way he looked at you, by yelling or smashing things)? Threatened to hurt you or someone you care about?

stages, by each of the other variables considered to have significant importance based on relevant literature (i.e., variables persistently identified by relevant literature to be associated with IPV, but were found not to be statistically significant in the simple logistic regression analysis of this study). To decide which variables to include in the final best fitting models, the extent to which each variable associates with IPV or attenuates the association of other variables in the models was examined via Wald test ($p < 0.05$), with the direction as well as degree of association expressed in the form of adjusted odds ratio and 95% confidence interval. Statistical significance of the final models was further assessed using omnibus chi-square test as well as Hosmer and Lemeshow test, with $p < 0.05$ and $p > 0.05$, respectively, indicating good fit.

IV. RESULTS

A. Prevalence

Characteristics of women and prevalence of IPV are given in Table II. In this presentation of results, any statement of life-time or current prevalence of IPV implies the prevalence of any form of life-time or current violence, unless otherwise stated to mean just a specific form of violence in particular (e.g., physical abuse).

The results show that the life-time and current prevalence of IPV are 25.5% and 16.7%, respectively, with psychological abuse being the dominant form of IPV (24.3% of women suffered this form of violence over a lifetime), followed closely by physical aggression (with a lifetime prevalence of 18.6%). The descriptive results also show that there is not much difference in the prevalence of IPV between the urban and rural areas. With regard to age, women within the age category of 50 years and above show higher exposure to IPV (having a lifetime prevalence of about 30.9%), and when the partner's age group is considered, women whose partners are between the ages of 30–49 show the highest level of IPV (a lifetime prevalence of 27.4%). Nonetheless, when the current exposure to IPV is considered, the descriptive statistics show that women within the age group of 30–49 consistently have the highest exposure to the different forms of IPV, only with the exception of sexual violence where women in the age group of 50 years and above are slightly more victimized (7.3% as compared with 7.2% in the 30–49 age group).

In terms of partnership age difference, women who are 1–4 years younger than their partners show higher level of IPV victimization—with a lifetime prevalence of approximately 29%. When compared with women having higher educational attainment,

those with lower or no attainment at all show greater prevalence of IPV (those with primary or no attainment at all having a lifetime prevalence of 48.9% and 43.0%, respectively). They also show similarly higher levels for current prevalence (42.2% and 35.5%). Just as in the case of the women, the results pertaining to partner's attainment indicate low cases of IPV victimization amongst women with partners having higher educational attainments (lifetime prevalence of 19.8% amongst those whose partners have tertiary/higher educational attainments, as compared with 34.7% amongst those having partners with primary or no attainments at all). When partnership educational difference is considered, the results show that relationships with educational disparities tend to be fraught with cases of IPV. Situations where women are better educated (i.e., have more educational attainment than their partners) as well as those where male partners are, respectively, indicate lifetime IPV prevalence levels of about 26% and 33%. The results also show that male partners having four or more controlling behaviors tend to be greater perpetrators of IPV—displaying a lifetime prevalence that is as high as 46.8%. The results also show that intimate partners who are physically, psychologically or sexually violent tend to have a history of drug use (substance abuse). Women with partners who use drugs every day or a couple of times in a month have a life-time IPV prevalence that ranges from 81.5%–90%, and are highly predisposed to experiencing all the forms of IPV. Women who reported often occurrence of discord (i.e., couples quarreling) in their relationships show remarkably higher experience of all the different forms of IPV (with a lifetime experience of IPV that is as high as 61.7% and a current prevalence of 47.3%). With regard to choice of spouse, results show that women who had a say in the choice of their spouse are less likely to be victims of IPV as compared with those who had no say whatsoever. Women who had no say at all in the selection of their spouses/partners show a lifetime prevalence of approximately 70% and a current prevalence of about 62%, while those who although had their partners chosen for them but consented to the choice have a lifetime and current prevalence of approximately 20% and 11%, respectively.

B. Women's Attitudes Towards Intimate Partner Violence

The distribution of attitudes of women towards IPV in terms of their acceptance of wife-beating in the study sample is given in Table III. The descriptive results presented in the table show that 33.5% of women agreed with the acceptability of wife-beating for at least one of the reasons stated earlier in the methods section of this paper. Support for wife-beating was slightly higher in the urban area than the rural area, with women in both areas showing acceptance levels of 35.4% and 31.5% respectively. In terms of educational attainment, women with primary or no attainment and those with secondary education tend to be more supportive of wife-beating (33.7% and 41.8%, respectively) as compared with those having higher educational attainment (26.3%). As regards age group of women, those in the age bracket of 18–29 years show the least acceptance of wife-beating (24.1%), while those in the age group of 30–49 years show the highest level of acceptance (38.6%). Considering women's literacy, those that are literate tend to show greater acceptance of wife-beating (35.4%) in comparison with those that are not literate (24.8%). The inferential statistical analysis (Chi-square) results indicate that woman's educational attainment, age, and literacy are all significantly related to her acceptance of wife-beating ($p < 0.05$). Nevertheless, the results also show that there is no significant difference in the proportion of rural dwelling women that accept wife-beating and those that are urban residents ($p > 0.05$).

C. Simple Logistic Regression Analysis

Table IV presents the results of the series of simple bivariate logistic regression analyses. The results show that there are significant associations ($p < 0.05$) between IPV and variables such as woman literacy, partner literacy, educational attainment of woman and that of her partner, partner's history of physical aggression, partner engaged in affairs with other women, partner's use of alcohol, partner's history of drug use, partner's controlling behavior, woman's frequency of communication with family, partnership educational difference, partnership discord, and choice of spouse or partner.

Women that are not literate were found to be approximately 2.7 times more predisposed to experiencing IPV as compared with those that are literate ($p < 0.001$). In a similar vein, women whose partners are not literate are also approximately 1.8 times more likely to experience IPV ($p = 0.008$). In terms of educational attainment, women with primary or no attainment are approximately 4 times more likely to experience IPV as compared with those having higher educational attainment ($p < 0.001$). Nonetheless, there is no significant difference between women with higher education and those with secondary. Regarding partner's educational attainment, women whose partners have primary or no attainment and those with secondary education are approximately 2 times more likely to experience IPV as compared with those whose partners have higher attainment ($p < 0.001$ and $p = 0.001$, respectively). Moreover, women whose partners have general history of physical aggression (i.e., have been involved in a physical fight with another man) are 3.5 times more likely to experience IPV than those whose partners have no such history ($p < 0.001$). Women reporting that their partners have or may have engaged in affairs with other women are more likely to experience IPV (1.8- and 3.6-fold increase in likelihood, respectively). Besides, women who reported that they are unaware of such affairs were also found to be approximately 2.5 times more predisposed to experiencing IPV as compared with those reporting non-existence of such affairs. As regards partner's use of alcohol, women whose partners consume alcohol everyday and those with a once a week rate are more likely to experience IPV when compared with those who reported their partners' abstinence from alcohol (approximately a 2.8- and 2.4-fold increase in likelihood, respectively). In terms of partner's history of drug use, women who reported that their partners use such substance one to four times a month and those that reported everyday usage are more likely to experience IPV when compared with those that reported no such usage (approximately 37.6- and 18.4-fold increase in likelihood, respectively). Nonetheless, women who reported that they are not aware of such substance abuse are also approximately 5 times more predisposed to experiencing IPV as compared with those women who categorically reported that their

partners have never used such substance. Regarding controlling behavior of partner (e.g., partner tries to prevent woman from seeing friends, restricts her contact with her family, and gets angry if she speaks with another man), the results show that women whose partners have one or more controlling behaviors are more prone to IPV as compared with those having partners without such behavior. The magnitude of likelihood of experiencing IPV increases as the number of controlling behavior increases. Those having partners showing one controlling behavior are approximately 4 times more likely to experience IPV, while those with partners showing two or three and four or more are approximately 8 and 24 times more likely to experience IPV, respectively. As regards to woman's frequency of communication with family, women who correspond at least once a month are approximately 2 times more likely to experience IPV when compared with those who correspond at least once a week ($p = 0.012$). Besides, those who correspond once a year or hardly ever are even more likely to experience IPV (approximately 3 times more likely) when compared with those who correspond at least once a week ($p < 0.001$).

In terms of partnership educational disparity, women in partnerships where their male partners are more educated than themselves are approximately 2 times more likely to experience IPV as compared with women in partnerships where the couples have same level of education ($p = 0.002$). Nonetheless, there is no significant difference in the exposure to IPV amongst women in partnerships where they are more educated than their partners and where they have same level of education. Regarding partnership discord, women reporting some form of quarreling with their partners are more predisposed to experiencing IPV as compared with those reporting no quarreling. Women with rare occurrence of quarreling are approximately 5 times more likely to experience IPV ($p = 0.002$), while those with often quarreling are even more exposed to IPV—approximately 35 times more likely to experience IPV ($p < 0.001$). As regards the choice of spouse or partner, women who have their spouses or partners chosen for them without their consent are approximately 8 times more likely to experience IPV as compared with those in partnerships where women and their partners chose one another ($p < 0.001$).

TABLE II
PREVALENCE OF PHYSICAL, PSYCHOLOGICAL, SEXUAL, AND ANY FORM OF VIOLENCE (PHYSICAL, PSYCHOLOGICAL, AND/OR SEXUAL) BY DEMOGRAPHIC CHARACTERISTICS OF THE WOMEN

Variable	Physical violence		Psychological violence		Sexual violence		Any form of violence		Total no. of women (n)
	Life-time (%)	Current (%)	Life-time (%)	Current (%)	Life-time (%)	Current (%)	Life-time (%)	Current (%)	
Area									
<i>Rural</i>	18.8	13.9	23.4	16.8	10.7	5.5	24.6	16.8	346
<i>Urban</i>	18.5	11.5	25.2	16.4	12.1	6.7	26.3	16.6	373
Woman's educational attainment									
<i>Tertiary/Higher</i>	9.1	4	14.8	6.4	6.7	1.7	16.8	6.7	297
<i>Secondary</i>	16.4	10.2	22.3	14.8	12.1	5.9	23	14.8	256
<i>None/Primary</i>	39.2	31.9	44.6	37.4	18.7	14.5	44.6	37.4	166
Woman's age									
<i>18 – 29</i>	15.3	8.4	24.5	11.2	12	4	27.3	11.6	249
<i>30 – 49</i>	20.2	15.2	23.4	19.5	10.6	7.2	23.6	19.5	415
<i>50 and above</i>	21.8	12.7	30.9	18.2	14.5	7.3	30.9	18.2	55
Partner's educational attainment									
<i>Tertiary/Higher</i>	11	6.1	18.2	10.1	8.5	3.4	19.8	10.3	445
<i>Secondary</i>	29.4	19.6	34	24.2	15	6.5	34.6	24.2	153
<i>None/Primary</i>	33.1	28.1	34.7	30.6	17.4	15.7	34.7	30.6	121
Partner's age									
<i>18 – 29</i>	11.1	4.2	18.8	6.9	12.5	2.1	22.9	6.9	144
<i>30 – 49</i>	21.9	16.7	27.1	20.5	9.6	6.8	27.4	20.8	365
<i>50 and above</i>	18.1	11.4	23.3	16.2	13.8	7.6	23.8	16.2	210
Partner's controlling behavior									
<i>None</i>	3.5	0.9	3.5	1.8	0	0	3.5	1.8	113
<i>One</i>	7.3	3.6	10	8.2	2.7	0.9	11.8	8.2	110
<i>Two or Three</i>	15.5	11.2	22.3	15.1	8.3	4.7	23	15.5	278
<i>Four or more</i>	36.2	25.2	45	30.3	25.7	13.8	46.8	30.3	218
Partner's history of drug use (substance abuse)									
<i>Never</i>	12.8	7.3	18.1	10.4	8.5	3.4	19.3	10.5	626
<i>1 – 4 times a month</i>	80	60	90	80	40	30	90	80	10
<i>Every day</i>	74.1	55.6	81.5	63	37	25.9	81.5	63	27
<i>Respondent does not know</i>	46.4	42.9	55.4	51.8	26.8	23.2	55.4	51.8	56
Partnership age difference									
<i>Woman is same age as partner</i>	21.7	17.4	26.1	17.4	13	4.3	26.1	17.4	23
<i>Woman is older</i>	15.4	15.4	15.4	15.4	15.4	7.7	15.4	15.4	13
<i>Woman is 1 – 4 years younger</i>	21.8	13.1	27.3	16.7	9.5	4.7	28.7	16.7	275
<i>Woman is 5 – 9 years younger</i>	18.2	13.3	24.4	18.7	14.7	7.6	26.2	19.1	225
<i>Woman is 10 or more years younger</i>	14.2	10.4	20.2	13.7	9.8	6.6	20.2	13.7	183

TABLE II
PREVALENCE OF PHYSICAL, PSYCHOLOGICAL, SEXUAL, AND ANY FORM OF VIOLENCE (PHYSICAL, PSYCHOLOGICAL, AND/OR SEXUAL) BY DEMOGRAPHIC CHARACTERISTICS OF THE WOMEN

Variable	Physical violence		Psychological violence		Sexual violence		Any form of violence		Total no. of women (n)
	Life-time (%)	Current (%)	Life-time (%)	Current (%)	Life-time (%)	Current (%)	Life-time (%)	Current (%)	
Partnership education difference									
<i>Same level</i>	15.3	9.7	20	11.9	9.4	4.5	21.6	12.1	445
<i>Partner better</i>	24.1	18	32.5	24.6	14	8.3	32.9	24.6	228
<i>Woman better educated</i>	23.9	15.2	26.1	21.7	17.4	10.9	26.1	21.7	46
Partnership discord									
<i>Never</i>	1.8	1.8	3.5	2.7	1.8	0.9	4.4	2.7	113
<i>Rarely</i>	11.2	5.7	15.7	8.4	6.6	1.6	17.1	8.7	439
<i>Often/sometimes</i>	49.7	38.3	61.1	47.3	30.5	21.6	61.7	47.3	167
Choice of spouse or partner									
<i>Both chose</i>	17.2	11.1	22.4	14.9	10.7	5.3	23.8	15	606
<i>Respondent chose</i>	0	0	10	0	0	0	10	0	20
<i>Others chose with woman's consent</i>	10.7	7.1	19.6	10.7	8.9	3.6	19.6	10.7	56
<i>Others chose w/o woman's consent</i>	64.9	54.1	70.3	62.2	32.4	27	70.3	62.2	56
Total	18.6	12.7	24.3	16.6	11.4	6.1	25.5	16.7	719

TABLE III
TABLE SHOWING THE DISTRIBUTION OF WOMEN'S ATTITUDES TOWARDS IPV (WIFE-BEATING)

Variable	Women's Acceptance of Wife Beating		Total no. of women (n)	Test Statistic
	Non-acceptance (%)	Acceptance (%)		
Area				
<i>Rural</i>	68.5	31.5	346	$\chi^2(1,n=719) = 1.05, p = 0.306$
<i>Urban</i>	64.6	35.4	373	
Woman's educational attainment				
<i>Tertiary/Higher</i>	73.7	26.3	297	$\chi^2(2,n=719) = 14.89, p = 0.001$
<i>Secondary</i>	58.2	41.8	256	
<i>None/Primary</i>	66.3	33.7	166	
Woman's age				
<i>18 – 29</i>	75.9	24.1	249	$\chi^2(2,n=719) = 15.18, p = 0.001$
<i>30 – 49</i>	61.4	38.6	415	
<i>50 and above</i>	61.8	38.2	55	
Woman literate				
<i>No</i>	75.2	24.8	125	$\chi^2(1,n=719) = 4.70, p = 0.030$
<i>Yes</i>	64.6	35.4	594	
Total	66.5	33.5	719	

TABLE IV
COEFFICIENTS, CRUDE ODDS RATIOS*, 95% CONFIDENCE INTERVAL, AND P-VALUE OF THE SIMPLE BIVARIATE LOGISTIC REGRESSION

Variable	Coefficient	OR (95% CI)	p-value
Woman's age group			0.359
18 – 29	0.00	1	
30 – 49	-0.20	0.82 (0.58 – 1.18)	0.287
50 and above	0.18	1.19 (0.63 – 2.25)	0.591
Partner's age group			0.470
18 – 29	0.00	1	
30 – 49	0.24	1.27 (0.81 - 1.99)	0.301
50 and above	0.05	1.05 (0.64 - 1.74)	0.846
Area			0.600
Urban	0.00	1	
Rural	-0.09	0.91 (0.65 – 1.28)	0.600
Woman literate			0.000
Yes	0.00	1	
No	1.01	2.74 (1.83 – 4.11)	0.000
Partner literate			0.008
Yes	0.00	1	
No	0.61	1.84 (1.17 – 2.90)	0.008
Woman's educational attainment			0.000
Tertiary/Higher	0.00	1	
Secondary	0.39	1.48 (0.97 – 2.25)	0.068
None/Primary	1.38	3.97 (2.58 – 6.12)	0.000
Partner's educational attainment			0.000
Tertiary/Higher	0.00	1	
Secondary	0.77	2.15 (1.43 – 3.32)	0.000
None or Primary	0.77	2.16 (1.39 – 3.35)	0.001
Woman in employment			0.612
Yes	0.00	1	
No	-0.10	0.90 (0.61 – 1.34)	0.612
Partner in employment			0.361
Yes	0.00	1	
No	-0.26	0.77 (0.44 – 1.35)	0.361
Partner's general history of physical aggression			0.000
No	0.00	1	
Yes	1.26	3.52 (2.39 – 5.20)	0
Woman (Respondent) do not know	0.54	1.72 (0.85 – 3.48)	0.134
Partner engaged in affairs with other women			0.000
No	0.00	1	
Yes	0.59	1.80 (1.10 – 2.96)	0.020
May have	1.28	3.61 (1.98 – 6.75)	0.000
Woman (Respondent) do not know	0.93	2.54 (1.59 – 4.05)	0.000
Partner's use of alcohol			0.000
Never	0.00	1	
Everyday	1.03	2.79 (1.80 – 4.33)	0.000
Once a week	0.87	2.40 (1.46 – 3.92)	0.001
1 – 3 times a month	0.37	1.45 (0.66 – 3.21)	0.358
Less than once a month	0.19	1.21 (0.44 – 3.36)	0.715
Partner's history of drugs use (substance abuse)			0.000
Never	0.00	1	
1 – 4 times a month	3.63	37.56 (4.71 – 299.31)	0.001
Everyday	2.91	18.36 (6.82 – 49.48)	0.000
Woman (Respondent) do not know	1.64	5.18 (2.95 – 9.09)	0.000

TABLE IV
 COEFFICIENTS, CRUDE ODDS RATIOS*, 95% CONFIDENCE INTERVAL, AND P-VALUE OF THE SIMPLE BIVARIATE LOGISTIC REGRESSION

Variable	Coefficient	OR (95% CI)	p-value
Partner's controlling behavior			0.000
<i>None</i>	0.00	1	
<i>One</i>	1.30	3.65 (1.15 – 11.58)	0.028
<i>2 or 3</i>	2.10	8.15 (2.89 – 22.97)	0.000
<i>4 or more</i>	3.18	23.96 (8.53 – 67.30)	0.000
Categorical number of children			0.091
<i>5 or more</i>	0.00	1	
<i>3 – 4</i>	-0.50	0.61 (0.38 – 0.98)	0.039
<i>1 – 2</i>	0.01	1.01 (0.60 – 1.68)	0.982
<i>None</i>	-0.31	0.74 (0.45 – 1.21)	0.229
Woman's frequency of communication with family			0.000
<i>Corresponds at least once a week</i>	0.00	1	
<i>Corresponds at least once a month</i>	0.52	1.68 (1.12 – 2.52)	0.012
<i>Corresponds like once a year or hardly ever</i>	1.03	2.80 (1.71 – 4.58)	0.000
Partnership status			0.476
<i>Currently married</i>	0.00	1	
<i>Currently living with a man but not married</i>	0.26	1.30 (0.52 – 3.25)	0.576
<i>Currently having a regular partner who lives apart</i>	-0.27	0.77 (0.49 – 1.20)	0.243
<i>Divorced/ broken up with partner</i>	-0.68	0.51 (0.11 – 2.31)	0.38
Consummation of partnership involves payments			0.814
<i>No payments</i>	0.00	1	
<i>Dowry and/or bride price</i>	0.1	1.11 (0.75 – 1.64)	0.608
<i>Woman unaware</i>	0.24	1.27 (0.52 – 3.08)	0.596
Partnership age difference			0.297
<i>Woman is same age as partner</i>	0.00	1	
<i>Woman is older</i>	-0.66	0.52 (0.09 – 3.03)	0.463
<i>Woman is 1 – 4 years younger</i>	0.13	1.14 (0.43 – 3.00)	0.788
<i>Woman is 5 – 9 years younger</i>	0.01	1.01 (0.38 – 2.68)	0.989
<i>Woman is 10 or more years younger</i>	-0.33	0.72 (0.27 – 1.95)	0.515
Partnership educational difference			0.006
<i>Same level</i>	0	1	
<i>Partner better educated</i>	0.58	1.78 (1.25 – 2.55)	0.002
<i>Woman better educated</i>	0.25	1.28 (0.64 – 2.57)	0.483
Partnership employment			0.222
<i>Both employed</i>	0	1	
<i>Only woman employed</i>	-1.12	0.33 (0.10 – 1.10)	0.071
<i>Only partner employed</i>	-0.27	0.76 (0.47 – 1.23)	0.264
<i>Both unemployed</i>	0.05	1.05 (0.56 – 1.96)	0.882
Partnership discord			0.000
<i>Never</i>	0.00	1	
<i>Rarely</i>	1.49	4.45 (1.76 – 11.28)	0.002
<i>Often/sometimes</i>	3.55	34.76 (13.45 – 89.82)	0.000
Choice of spouse or partner			0.000
<i>Both chose</i>	0.00	1	
<i>Woman (Respondent) chose</i>	-1.03	0.36 (0.08 – 1.56)	0.170
<i>Others chose with woman's consent</i>	-0.24	0.78 (0.40 – 1.56)	0.487
<i>Others chose without woman's consent</i>	2.03	7.58 (3.66 – 15.73)	0.000

Nonetheless, it should be noted that the consent of the woman is of pivotal importance, as there is no significant difference in the experience of IPV by women in partnerships where both women and their partners chose one another and those in partnerships where others chose the women's partners but with their consent.

D. Multivariate Analysis

1) *Individual-level Predictors Model:* Having conducted series of simple logistic regression analyses aimed at unraveling crude associations between different variables and IPV, the following variables were found to be significantly associated with IPV and included in the individual-level multi-variable analysis: woman literacy, partner literacy, educational attainment of woman and that of her partner, partner's history of physical aggression, partner engaged in affairs with other women, partner's use of alcohol, partner's history of drug use, partner's controlling behavior and categorical number of children. Furthermore, some other variables not found to be significantly associated with IPV were also considered for inclusion in the multivariable model based on their importance as highlighted in relevant literature. These variables include: woman's age, partner's age, and number of children. Evidence supporting their relevance could be found in the research work of [3], [8], [19], [20], [21].

Table V presents the details of variables in the final parsimonious model fitted at the individual level [$\chi^2(25, N = 719) = 235.76, p < 0.001$; Hosmer and Lemeshow: $p = 0.679$]. After the multivariable analysis, variables including women's age group, women's educational attainment, partner's educational attainment, partner's controlling behavior, and partner's use of drugs (substance taken for its narcotic effects) all having significant (main) effect in predicting IPV occurrence in the fitted model ($p < 0.05$). Other variables (e.g., women's literacy and partner's age group) were all included in the model as covariates providing needed adjustment of the effects of the set of variables mentioned earlier. In other words, they are important confounders, even though their association with IPV is not statistically significant in the model ($p > 0.05$).

In the main effect variables, women within the age group of 30–49 years compared with those in

the youngest age group (18–29) were 2.3 times less likely to experience IPV ($p = 0.011$). Considering women's educational attainment, lower attainment (primary education), or no attainment at all exposes women to IPV victimization ($p < 0.001$), with women having primary or no attainments about 7 times more likely to experience IPV than those having higher attainments. As opposed to the case of women, partner's higher educational attainments actually increased the occurrence of violence ($p = 0.04$). Compared with male partners having tertiary attainments, those with primary or no attainments at all indicated a lower perpetration of IPV—about 2.5 times less likely to commit violence ($p = 0.023$). Regarding a partner's controlling behavior, the result shows that greater controlling behavior is directly proportional to a higher likelihood of perpetrating IPV ($p < 0.001$). Indeed, partners exhibiting 4 or more controlling behaviors have a 26.8-fold increase in likelihood of perpetrating IPV compared to those without any controlling behavior. Results on partner's history of drug use show that, in comparison with male partners who have never used drugs, those who indulge in daily usage or 1 to 4 times a month were 16.8 to 46.5 times more likely to be perpetrators of IPV ($p < 0.001$).

2) *Relationship-level Predictor Model:* Furthermore, after the simple bivariate logistic regression analysis, the following relationship-level variables were significantly associated with IPV: partnership educational difference, partnership discord, and choice of spouse or partner. Thus, the variables were entered into the relationship-level multivariable analysis. Besides, just as in the case of the individual-level multivariable analysis, other relationship-level variables not statistically related to IPV in the simple bivariate analysis—partnership age difference and consummation of partnership involving payments—were also considered. This extra inclusion was considered as research indicates the likely importance of the variables in predicting IPV [9], [22], [23].

In Table VI, the model fitted separately for relationship level variables [$\chi^2(11, N = 719) = 190.36, p < 0.001$; Hosmer and Lemeshow: $p = 0.651$] shows that partnership age-difference, partnership educational difference, partnership discord, and choice of spouse all contribute significantly to the model ($p < 0.05$).

In terms of partnership age difference, women with partners who are 10 or more years older than themselves showed significant reduction in IPV occurrence, when compared with couples of equal age ($p = 0.032$). The age difference conferred a 3.6-fold reduction in the likelihood of experiencing IPV. Considering partnership educational difference, men having better education than their partners were found to perpetrate IPV 2.1 times more than those having the same level of education as their partners ($p = 0.002$). In comparison with women who reported no partnership discord, those who reported rare or frequent occurrence of discord were found to have a 5- and 38-fold increase in the experience of IPV, respectively ($p < 0.001$). Regarding choice of spouse, cases where women had no say in selecting their partners showed a 5.2-fold increase in IPV experience, when compared with partnerships involving couples choosing one another of their own volition ($p < 0.001$).

V. DISCUSSION AND CONCLUSION

The findings of this study show a relatively high level of IPV (about 1 out of every 4 women has experienced IPV at least once in her life-time), consistent with the pervasiveness reported by other research [3], [7]. The study found that psychological abuse was the highest form of IPV experienced by women (life-time and current prevalence of 24.3% and 16.6%, respectively), lending further credence to observations of prior studies [15], [24]. This high level of IPV victimization indicates how imperative it is for the government and other relevant stakeholders to act swiftly in providing support for abused women and, most importantly, develop policies to prevent the occurrence of violence.

The results also show widespread acceptance of wife-beating across urban and rural areas; which is, again, an indication of the need for greater IPV preventive measures. This need becomes even more pressing when one considers the fact that the level of acceptability of wife-beating recorded in this study is as high as (perhaps even higher than) those recorded around the world, especially those in Latin American countries—some of whom have deemed this issue very serious and have taken certain steps to address the issue [18], [21], [22], [25], [26]. Besides, the results showing literate women

to be more supportive of wife-beating might be an indication of patriarchy and cultural approval of violence against women within the Nigerian society. The results could also suggest the plausibility of exchange theory as expressed by [27]—decrease in violence as women's economic resource/power increases. These two notions (i.e., cultural approval of violence and exchange theory) could be pertinent as literacy is likely to confer some form of economic power on literate women (e.g., greater likelihood of getting better paid jobs) and as a result have less exposure to IPV, but with the influence of dominant societal norms of patriarchy they may accept wife-beating under certain socially justified conditions. On the other hand, illiterate women may be exposed to greater IPV victimizations due to limited economic leverage and, as a result, develop an aversion towards wife-beating despite cultural approval of such violence as a normative practice in asserting male authority. Thus, the probable deficient sensitivity of literate women to IPV issues fueled by patriarchal societal norms is a further testament to the need for more robust policies and actions, preferably those built on school-based enlightenment schemes/interventions or based on community mobilization and mass communication for social change, as these strategies have been shown to have effective impact on raising awareness about the issue of IPV and prevention of its occurrence [3], [21], [28], [29].

Moreover, the analysis performed in fitting the best and most parsimonious model for individual-level variables indicates that women's age, women's and partner's educational attainments, partner's history of drug use, and partner's controlling behavior all associate significantly with IPV. In the case of relationship-level variables, factors such as partnership age difference, partnership educational difference, partnership discord, and choice of partner were statistically significant. Some of these factors at both individual- and relationship-level have also been reported by other studies, especially those conducted in developed countries, to strongly associate with IPV occurrence in a similar fashion, while others have shown different results.

The individual-level model suggests that young age amongst women increases the likelihood of experiencing IPV, corroborating the results of other studies that indicate similar findings [30], [31]. In

TABLE V
COEFFICIENTS, ADJUSTED ODDS RATIOS*, 95% CONFIDENCE INTERVAL AND P-VALUE OF THE BEST FITTING LOGISTIC REGRESSION MODEL FOR THE INDIVIDUAL LEVEL VARIABLES

Variable	Coefficient	OR (95% CI)	p-value
Woman's age group			0.036
18 – 29	0.00	1	
30 – 49	-0.85	0.43 (0.22 – 0.83)	0.011
50 and above	-0.56	0.57 (0.19 – 1.68)	0.308
Partner's age group			0.652
18 – 29	0.00	1	
30 – 49	0.34	1.40 (0.66 – 2.98)	0.382
50 and above	0.24	1.27 (0.47 – 3.45)	0.638
Woman literate			0.133
Yes	0.00	1	
No	-0.73	0.48 (0.19 – 1.25)	0.133
Woman's educational attainment			0.000
Tertiary/Higher	0.00	1	
Secondary	0.36	1.43 (0.84 – 2.44)	0.193
None or Primary	1.94	6.98 (2.84 – 17.19)	0.000
Partner's educational attainment			0.040
Tertiary/Higher	0.00	1	
Secondary	0.03	1.03 (0.58 – 1.84)	0.913
None or Primary	-0.90	0.41 (0.19 – 0.88)	0.023
Partner's general history of physical aggression			0.053
No	0.00	1	
Yes	0.66	1.94 (1.13 – 3.33)	0.017
Woman (Respondent) do not know	-0.02	0.98 (0.40 – 2.42)	0.969
Partner engaged in affairs with other women			0.056
No	0.00	1	
Yes	0.18	1.19 (0.60 – 2.37)	0.612
May have	0.95	2.58 (1.28 – 5.22)	0.008
Woman (Respondent) do not know	0.41	1.51 (0.87 – 2.61)	0.143
Partner's history of drugs use (substance abuse)			0.000
Never	0.00	1	
1 – 4 times a month	3.84	46.54 (4.88 – 443.94)	0.001
Everyday	2.82	16.82 (4.81 – 58.79)	0.000
Woman (Respondent) do not know	1.48	4.38 (2.17 – 8.85)	0.000
Partner's controlling behavior			0.000
None	0.00	1	
One	1.76	5.80 (1.63 – 20.63)	0.007
2 or 3	2.20	8.98 (2.88 – 27.97)	0.000
4 or more	3.29	26.80 (8.58 – 83.77)	0.000
Categorical number of children			0.086
5 or more	0.00	1	
3 – 4	-0.84	0.43 (0.23 – 0.82)	0.011
1 – 2	-0.61	0.54 (0.25 – 1.16)	0.115
None	-0.50	0.60 (0.25 – 1.45)	0.258
Woman's frequency of communication with family			0.104
Corresponds at least once a week	0.00	1	
Corresponds at least once a month	0.41	1.50 (0.91 – 2.46)	0.110
Corresponds like once a year or hardly ever	0.57	1.76 (0.94 – 3.33)	0.080

*Odds ratio adjusted for all variables in the table (model)

OR = Odds ratio, CI = Confidence interval

TABLE VI
COEFFICIENTS, ADJUSTED ODDS RATIOS*, 95% CONFIDENCE INTERVAL AND P-VALUE OF THE BEST FITTING LOGISTIC REGRESSION MODEL FOR THE RELATIONSHIP LEVEL VARIABLES

Variable	Coefficient	OR (95% CI)	p-value
Partnership age difference			0.002
<i>Woman is same age as partner</i>	0.00	1	
<i>Woman is older</i>	-0.76	0.47 (0.06 - 3.47)	0.458
<i>Woman is 1 - 4 years younger</i>	-0.18	0.84 (0.28 - 2.55)	0.755
<i>Woman is 5 - 9 years younger</i>	-0.70	0.50 (0.16 - 1.55)	0.230
<i>Woman is 10 or more years younger</i>	-1.28	0.28 (0.09 - 0.89)	0.032
Partnership educational difference			0.002
<i>Same level</i>	0.00	1	
<i>Partner better educated</i>	0.73	2.07 (1.35 - 3.17)	0.001
<i>Woman better educated</i>	-0.16	0.85 (0.37 - 1.99)	0.713
Partnership discord			0.000
<i>Never</i>	0.00	1	
<i>Rarely</i>	1.61	5.00 (1.94 - 12.88)	0.001
<i>Often/ sometimes</i>	3.64	38.03 (14.26 - 101.40)	0.000
Choice of spouse or partner			0.002
<i>Both chose</i>	0.00	1	
<i>Respondent chose</i>	-0.29	0.75 (0.16 - 3.44)	0.712
<i>Others chose with woman's consent</i>	-0.44	0.65 (0.29 - 1.43)	0.281
<i>Others chose without woman's consent</i>	1.65	5.21 (2.11 - 12.88)	0.000

*Odds ratio adjusted for all variables in the table (model)

OR = Odds ratio, CI = Confidence interval

terms of educational attainment, low level of attainment has been consistently reported in association with male perpetration and women victimization of IPV [9], [11], [12]. In line with these findings, women with lower educational attainment in this study were found to experience significantly higher occurrence of IPV. On the opposite side, results pertaining to male partner educational attainment in this study refute those of the earlier studies stated, as higher educational attainment was found to increase IPV perpetration. Nonetheless, this particular finding lends credence to resource theory – which posits that male violence is a resource of last resort when other forms of resources are unavailable [32], [33]. This is plausible as a lot of graduates of higher institutions in Nigeria are unemployed and struggle to make ends meet, making them a likely user of the ‘last resort’ (violence) when other resources that can support standard living are not available. The applicability of resource theory is germane, despite the fact that analyses pertaining to employment status (simple logistic regression analysis of male partner employment in particular) show that there is no significant difference in the likelihood of experiencing IPV between women whose partners

are employed and those with unemployed partners. This is so because being employed in Nigeria does not necessarily imply having the resources to make ends meet, especially with studies showing that most jobs simply pay too little in the country [34].

Considering controlling behavior, the results of this study indicating a higher IPV perpetration with greater control corroborate those of [9] who found that such behavior was strongly associated with IPV across a host of different countries. With regard to male partner drug use, strong positive correlations with IPV perpetration have been reported by various studies, even after controlling for women’s substance abuse [35], [36]. The results of this study are also consistent with these prior findings.

Furthermore, research has shown that women with a higher level of education relative to their partners are more prone to IPV experience [12], [37]. However, the results in this study indicate that women with lower educational attainment than their male partners are more predisposed to experiencing IPV. This finding supports that of [11], and lends a further credence to the plausibility of resource theory as stated earlier. Studies have reported varying results on the association of IPV with age disparity between

male and female partners, but a dominant finding is that women with older partners (at least five or more years older) have lower likelihood of experiencing IPV [9], [19]. The results of this study also show similar association. Just as in age disparity, research on women taking an active role in choosing their partners has come up with contrasting results. The most common view is that lack of say in the choice of partner is significantly associated with IPV occurrence [9], and this is also supported by the results in this study. Relationship discord is another factor that associates with IPV in this study, with discord increasing the likelihood of IPV by several folds. The work of [23] provides additional evidence supporting these results.

Finally, having considered the similarities of the results in this study with those elsewhere, it can be concluded that controllable factors such as educational attainment (especially that of women), male partner's drug use, controlling behavior, restricted liberty of women in selecting their partners, and partnership discord should all be given reasonable consideration in terms of policy setting and development of preventive interventions. Furthermore, the level of acceptability of IPV (wife-beating) should also be of major concern, and as stated earlier school-based interventions and community awareness campaigns could go a long way in addressing this particular issue. In addition, pre-school enrichment programs and other programs promoting equal access to education for males and females would help improve women's educational attainment along with those of their male counterparts and could also provide a strong platform for other preventive actions. Adopting this kind of strategy would not just help stem down IPV, it would also support the achievement of targets of important movements, for example, the UN Millennium Development Goals, especially goal 3 - Gender Equality and Women Empowerment, and goal 2 - Universal Primary Education [38].

Nonetheless, the findings of this study have shown that situations elsewhere do not necessarily mirror what is happening in Nigeria. As a result, adopting a one-size-fits-all approach to intervention (i.e., direct usage of policies/intervention developed for other countries or settings) would not always succeed and therefore there is a need for more exploration of in-country IPV issues, as well as for the design

of appropriate interventions tailored to capture the somewhat unique Nigerian experience.

REFERENCES

- [1] World Health Organization, "Putting women first: Ethical and safety recommendations for research on domestic violence against women," World Health Organization, Geneva, Switzerland, Tech. Rep., 2001.
- [2] M. Ellsberg and L. Heise, "Researching violence against women: A practical guide for researchers and activists," World Health Organization PATH, USA, Tech. Rep., 2005.
- [3] World Health Organization, "Preventing intimate partner and sexual violence against women: Taking action and generating evidence," World Health Organization, Geneva, Switzerland, Tech. Rep., 2010.
- [4] N. Duvvury, P. Carney, and N. H. Minh, "Estimating the cost of domestic violence against women in Vietnam," United Nations Women Vietnam, Hanoi, Vietnam, Tech. Rep., 2012.
- [5] J. C. Kim, C. H. Watts, J. R. Hargreaves, L. X. Ndhlovu, G. Phetla, L. A. Morison, J. Busza, J. D. Porter, and P. Pronyk, "Understanding the impact of a microfinance-based intervention on women's empowerment and the reduction of intimate partner violence in South Africa," *American Journal of Public Health*, vol. 97, no. 10, pp. 1794–1802, 2007.
- [6] L. Heise and C. Garcia-Moreno, *World Report on Violence and Health*. Geneva, Switzerland: World Health Organization, 2002, ch. Violence by Intimate Partners, pp. 87–121.
- [7] Economic Policy Research Centre, "Intimate partner violence: Estimating its cost and effect in Uganda kampala," Economic Policy Research Centre, Uganda, Tech. Rep., 2009.
- [8] C. García-Moreno, H. A. Jansen, M. Ellsberg, L. Heise, and C. Watts, "Who multi-country study on women's health and domestic violence against women," World Health Organization, Geneva, Switzerland, Tech. Rep., 2005.
- [9] T. Abramsky, C. H. Watts, C. Garcia-Moreno, K. Devries, L. Kiss, M. Ellsberg, H. A. Jansen, and L. Heise, "What factors are associated with recent intimate partner violence? Findings from the who multi-country study on women's health and domestic violence," *BMC Public Health*, vol. 11, no. 1, 2011.
- [10] M. J. Hindin and L. S. Adair, "Who's at risk? factors associated with intimate partner violence in the Philippines," *Social Science & Medicine*, vol. 55, no. 8, pp. 1385–1399, 2002.
- [11] M. A. Koenig, R. Stephenson, S. Ahmed, S. J. Jejeebhoy, and J. Campbell, "Individual and contextual determinants of domestic violence in north India," *American Journal of Public Health*, vol. 96, no. 1, pp. 132–138, 2006.
- [12] L. K. Ackerson, I. Kawachi, E. M. Barbeau, and S. Subramanian, "Effects of individual and proximate educational context on intimate partner violence: A population-based study of women in India," *American Journal of Public Health*, vol. 98, no. 3, pp. 507–514, 2008.
- [13] C. T. Taft, T. Bryant-Davis, H. E. Woodward, S. Tillman, and S. E. Torres, "Intimate partner violence against African American women: An examination of the socio-cultural

- context,” *Aggression and Violent Behavior*, vol. 14, no. 1, pp. 50–58, 2009.
- [14] O. A. Uthman, S. Lawoko, and T. Moradi, “Sex disparities in attitudes towards intimate partner violence against women in sub-saharan Africa: A socio-ecological analysis,” *BMC Public Health*, vol. 10, no. 1, p. 1, 2010.
- [15] National Population Commission, Nigeria and ICF Macro, “Nigeria demographic and health survey 2008,” National Population Commission, Nigeria and ICF Macro, Abuja, Nigeria, Tech. Rep., 2008.
- [16] L. Olayanju, R. Naguib, Q. Nguyen, R. Bali, and N. Vung, “Combating intimate partner violence in Africa: Opportunities and challenges in five African countries,” *Aggression and Violent Behavior*, vol. 18, no. 1, pp. 101–112, 2013.
- [17] International Center for Research on Women, “Intimate partner violence: High costs to households and communities,” International Center for Research on Women, Washington, DC, Tech. Rep., 2009.
- [18] J. Fanslow, E. Robinson, S. Crengle, and L. Perese, “Juxtaposing beliefs and reality: Prevalence rates of intimate partner violence and attitudes to violence and gender roles reported by New Zealand women,” *Violence Against Women*, vol. 16, no. 7, pp. 812–831, 2010.
- [19] M. J. Hindin, S. Kishor, and D. L. Ansara, “Intimate partner violence among couples in 10 dhs countries: Prediction and health outcomes,” Macro International Inc., Calverton, MD, Tech. Rep., 2008.
- [20] N. Abrahams, R. Jewkes, M. Hoffman, and R. Laubsher, “Sexual violence against intimate partners in Cape Town: Prevalence and risk factors reported by men,” *Bulletin of the World Health Organization*, vol. 82, no. 5, pp. 330–337, 2004.
- [21] S. Bott, A. Guedes, M. Goodwin, and J. A. Mendoza, “Violence against women in latin America and the caribbean: A comparative analysis of population-based data from 12 Countries,” Pan American Health Organization, Washington, DC, Tech. Rep., 2012.
- [22] A. Morrison, M. Ellsberg, and S. Bott, “Addressing gender-based violence: A critical review of interventions,” *The World Bank Research Observer*, vol. 22, no. 1, pp. 25–51, 2007.
- [23] S. M. Stith, D. B. Smith, C. E. Penn, D. B. Ward, and D. Tritt, “Intimate partner physical abuse perpetration and victimization risk factors: A meta-analytic review,” *Aggression and Violent Behavior*, vol. 10, no. 1, pp. 65–98, 2004.
- [24] L. E. Okenwa, S. Lawoko, and B. Jansson, “Exposure to intimate partner violence amongst women of reproductive age in lagos, Nigeria: Prevalence and predictors,” *Journal of Family Violence*, vol. 24, no. 7, pp. 517–530, 2009.
- [25] A. R. Morrison and M. L. Biehl, *Too Close to Home: Domestic Violence in the Americas*. Washington, DC: Inter American Development Bank, 1999.
- [26] I. S. Speizer, “Intimate partner violence attitudes and experience among women and men in Uganda,” *Journal of Interpersonal Violence*, vol. 25, no. 7, pp. 1224–1241, 2010.
- [27] C. M. Gibson-Davis, K. Magnuson, L. A. Gennetian, and G. J. Duncan, “Employment and the risk of domestic abuse among low-income women,” *Journal of Marriage and Family*, vol. 67, no. 5, pp. 1149–1168, 2005.
- [28] V. A. Foshee, K. E. Bauman, S. T. Ennett, C. Suchindran, T. Benefield, and G. F. Linder, “Assessing the effects of the dating violence prevention program “safe dates” using random coefficient regression modeling,” *Prevention Science*, vol. 6, no. 3, pp. 245–258, 2005.
- [29] World Health Organization, “Violence prevention - the evidence: Promoting gender equality to prevent violence against women,” World Health Organization, Geneva, Switzerland, Tech. Rep., 2009.
- [30] S. Romans, T. Forte, M. M. Cohen, J. Du Mont, and I. Hyman, “Who is most at risk for intimate partner violence? a canadian population-based study,” *Journal of Interpersonal Violence*, vol. 22, no. 12, pp. 1495–1514, 2007.
- [31] N. D. Vung, P.-O. Ostergren, and G. Krantz, “Intimate partner violence against women in rural Vietnam-different socio-demographic factors are associated with different forms of violence: Need for new intervention guidelines?” *BMC Public Health*, vol. 8, no. 1, p. 1, 2008.
- [32] M. P. Atkinson, T. N. Greenstein, and M. M. Lang, “For women, breadwinning can be dangerous: Gendered resource theory and wife abuse,” *Journal of Marriage and Family*, vol. 67, no. 5, pp. 1137–1148, 2005.
- [33] L. A. McCloskey, “Socioeconomic and coercive power within the family,” *Gender & Society*, vol. 10, no. 4, pp. 449–463, 1996.
- [34] F. Teal, “Employment creation, poverty and the structure of the job market in Nigeria,” Centre for the Study of African Economies, University of Oxford, Oxford, UK, Tech. Rep., 2014.
- [35] R. Jewkes, “Intimate partner violence: Causes and prevention,” *The Lancet*, vol. 359, no. 9315, pp. 1423–1429, 2002.
- [36] A. L. Coker, P. H. Smith, R. E. McKeown, and M. J. King, “Frequency and correlates of intimate partner violence by type: Physical, sexual, and psychological battering,” *American Journal of Public Health*, vol. 90, no. 4, 2000.
- [37] X. Xu, F. Zhu, P. O’Campo, M. A. Koenig, V. Mock, and J. Campbell, “Prevalence of and risk factors for intimate partner violence in China,” *American Journal of Public Health*, vol. 95, no. 1, pp. 78–85, 2005.
- [38] United Nations, “Millenium development goals report 2013,” United Nations, New York, USA, Tech. Rep., 2013.

Application of Genetic Algorithm and Wavelet Transform in Eye-Blink Detection from Electroencephalograms

Roy Francis Navea and Elmer Dadios

Abstract—This paper presents an algorithm for detecting eye-blink artefacts in an electroencephalogram (EEG) signal using optimized wavelets. The algorithm is based on genetic algorithm optimization techniques and wavelet transform. A mother wavelet was made to fit the sought after waveform in the EEG signal using genetic algorithm (GA). A mother wavelet, the Shannon (Sinc) wavelet, was deliberately altered using a fitness function described by significant contributing parameters used for translating and scaling the wavelet. Once the optimized wavelet is obtained, it was made to run through an EEG signal to search for likeliness which is determined by a threshold correlation value obtained using shape language modeling (SLM). Other methods were considered in detecting the eye-blinks such as the manual observation and the kurtosis method. Results show a significant difference in the counting results of the three methods covered by this paper. As for the proximity of counts, the wavelet method counts eye blink signals closer to the manually observed counting. Results also show a significant difference between the wavelet-based and the kurtosis-based eye blink counting methods.

Index Terms—EEG, eye-blinks, genetic algorithm, fitness function, wavelet.

I. INTRODUCTION

ON the average, eye blinks occur once every five seconds. Increased or decreased rate of eye blinking routines may indicate symptoms of eye blinking problems. Eye blinks happen to avoid drying out of the eye globe or even to protect the eye from outside irritants. Increased rate of eye blink

can also be observed from persons who are stressed, anxious, or exhausted [1]. Hereditary eye diseases, like the open-angle glaucoma, may possibly be an initial indicator of abnormal increased eye blinking activities [1], [2].

Irregular eye blinking can also be traced in the nervous system such as the condition known as Blepharospasm. Some other includes stroke, tardive, dyskinesia, Tourettes syndrome, or the Aicardi syndrome. A severe decrease in blinking is seen chiefly in Parkinsons disease. Facial paralysis and lack of facial expression including ostensive staring usually accompany decreased rate of eye blinks [2].

Eye blinks in EEG are one of the major sources of physiological noise especially if EEG recording is done when the eyes are open. Several algorithms were proposed to detect eye-blinks signals from EEG. One of which is the constrained blind source separation algorithm (CBSS). This is an effective way of removing eye muscle artifacts from electroencephalograms. By applying CBSS, the cross-correlation coefficient between the estimated sources and the artifact has been considerably reduced [3].

Due to the stochastic nature of EEG, statistical characterization were also used to describe their behavior [4]. Statistical measures include expectance, variance, skewness, and kurtosis for which the order is arranged from first to fourth, respectively [5]. These measures can be used as inputs in a neural network classification system to identify the occurrence of an eye blink in an EEG stream [4].

EEG sensors may appear to have a few or several nodes to capture the activities of the brain from the scalp. In an experiment [6], a three-electrode system was used to capture brain activities by considering four distinct conditions. These are with relaxed and

R. F. Navea is with the Electronics and Communications Engineering Department, De La Salle University, Manila, Philippines

E. Dadios is with the Manufacturing Engineering and Management Department, De La Salle University, Manila, Philippines

voluntary eye blinks; eyes closing and several eye movements. The study proved the effective capturing ability of the electrodes in which the eye-blink artifacts are easily seen after several signal processing algorithms were performed. Kurtosis, which is a fourth-order statistical measure, was used in the experiment. Output coefficients greater than 3.0 were used as an indicator of an eye blink signal [7]. Nonetheless, the kurtosis is a considerable parameter to determine the occurrence of an eye blink.

Genetic algorithm and wavelet transform were used to semi-automatically detect the presence of an epilepsy spike [8]. A mother wavelet was chosen and optimized to fit the desired EEG signal by designing a fitness function to work in the genetic algorithm. High selectivity and sensitivity percentages were obtained that contributes to high accuracy levels.

This paper intends to propose a method in which a certain waveform, designed to match a specific EEG segment waveform (such as an eye blink segment), can be used to run through an EEG stream to search for likelihood. Optimization techniques were exploited to find the best fitted waveform to match a certain target EEG waveform. In this paper, a proposed method for eye blink detection using optimized wavelet by genetic algorithm optimization search is presented. A typical eye-blink signal was extracted from the EEG samples. It was wavelet transformed to optimize a new wavelet that will suit its characteristics.

The remainder of this paper are organized into sections. Section II contains the details of the EEG data set used and how it was pre-processed. Section III discusses the optimization procedures and how the detection and counting was done. Section IV shows the discussion of the results and Section V draws the significant conclusion of this research.

II. EEG DATA SET AND PRE-PROCESSING

A. EEG Data Source

The EEG data used in this study were taken from 12 students who were observed while taking a computer-based examination using the Aplusix math learning software [9]. Video footages were used to manually observe the occurrence of the eye blink and marked it against the EEG signal obtained using the Emotiv EPOC, a 14-channel wireless EEG system

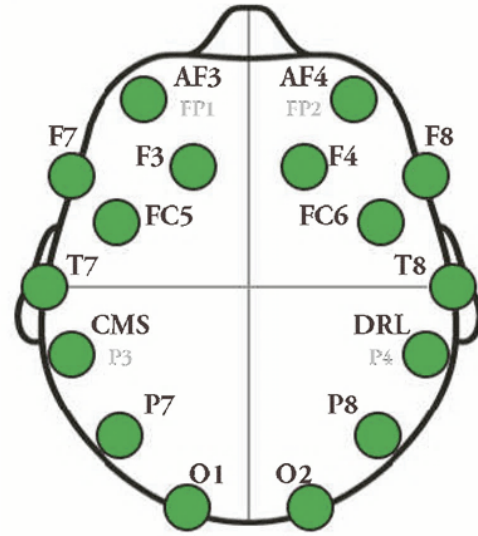

Fig. 1. EEG channel locations [11].

developed by Emotiv Systems [10]. The EEG electrode locations are shown in Fig. 1. The 14 channels are arranged and coded as AF3, F7, F3, FC5, T7, P7, O1, O2, P8, T8, FC6, F4, F8, and AF4. The letters F, T, P, C and O stands for frontal, temporal, parietal, central, and occipital lobes, respectively. The electrodes were checked to green all the time in the Emotiv SDK user interface. This is to ensure excellent signal reception using a wireless interface. The channels used in this study are the combined output of AF3 and T7, both are located on the left hemisphere of the brain. The combination was made to easily see the occurrence of the eye blink signals.

B. Kurtosis Method

Kurtosis is a fourth-order central momentum that characterizes the relative flatness or peakedness of the signal distribution. It is mathematically defined by

$$\text{kurtosis} = \frac{1}{N} \sum_{j=1}^N \left[\frac{x_j - \bar{x}}{S} \right]^4 \quad (1)$$

where N is the total number of samples, x_j is the data point at index j which runs from 1 to N . \bar{x} is the mean of the sampled data with a standard deviation S .

Kurtosis values greater than 3.0 (Leptokurtic distribution) indicates that the values are concentrated

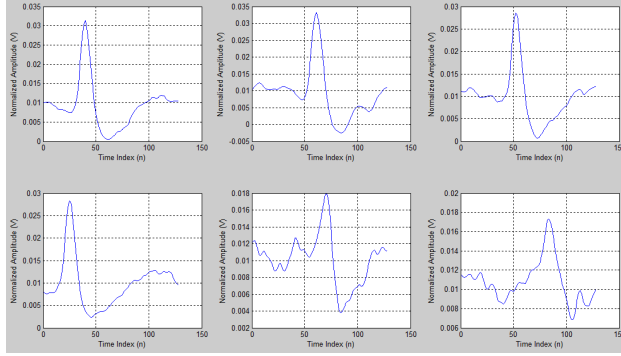

Fig. 2. Sample eye blink signals.

around the mean with thicker tails. This is sharper than a normal distribution with high probability of extreme values. Kurtosis less than 3.0 (Platykurtic distribution) shows a flatter curve as compared to a normal distribution. The probability for extreme values is less than a normal distribution, and they are wider spread around the mean. Kurtosis equal to 3.0 (Mesokurtic distribution) is a normal distribution. Eye blink signals are Leptokurtic and their kurtosis is around 3.0 but not greater than 5.0 [7], [12].

A 1-minute EEG stream, sampled at 128 samples per second, was used. This resulted to a total of 7680 sampled segments. The raw EEG was standardized using the z-score standardization procedure defined by

$$z = \frac{(x - \bar{x})}{S} \quad (2)$$

where x is the data point, \bar{x} is the mean of the sampled data with a standard deviation S . Z-scoring is the standardization of data that measure the distance of a data point from the mean in terms of the standard deviation. Standardization results to a mean of 0 and unity standard deviation, thus retains the shape properties of the original data set.

A looping program was created to do an eye blink search using the kurtosis values. The sought eye blink signals were plotted and six were chosen according to the physical appearance of typical eye blink signal. Fig. 2 shows the six sample eye blink signals.

The continuous wavelet transform (CWT) of the sample eye blink signals were obtained to serve as the basis of the coefficients of the wavelet that is going to be designed. The Shannon wavelet was used

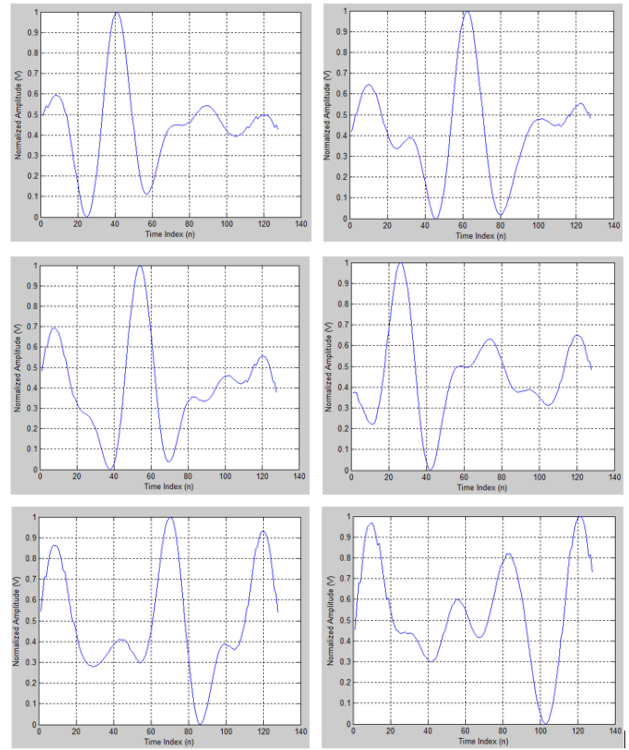

Fig. 3. CWT coefficients of the marked eye blink signal.

as the mother wavelet scaled with 32 levels. The Shannon wavelet was described in Section III-A.

For uniformity, the coefficients were normalized using

$$\text{coef}_{\text{norm}} = \frac{\text{coef} - \text{coef}_{\text{min}}}{\text{coef}_{\text{max}} - \text{coef}_{\text{min}}} \quad (3)$$

This will keep the coefficient values within the range of 0 and 1. The real CWT coefficients are plotted in Fig. 3. The number of levels were based from a power of two or $2n$. This restricts the arbitrary selection of the number of levels. It is noticeable also in Fig. 3 that when the CWT of eye blink signals were obtained with 32 levels, they resemble an appearance close to the appearance of the Shannon wavelet basis function (Fig. 5). This cannot be attained with levels more than or less than 32.

For optimization, a single waveform was obtained from the six eye blink signals. The plotted CWT coefficients of the marked eye blink signal is shown in Fig. 4.

The marked eye blink signal has 128 samples. It has a maximum and minimum normalized amplitudes of 1 V and 0 V located at the 52nd and 36th

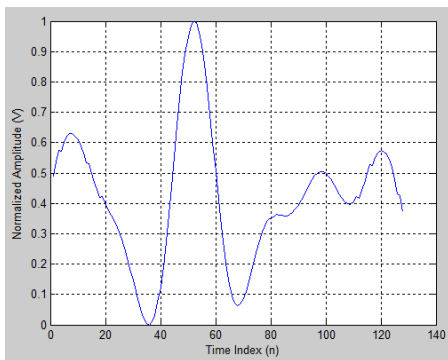

Fig. 4. CWT coefficients of the marked eye blink signal.

index along the x-axis, respectively. Its expectance normalized amplitude is 0.4224V with 0.0497 variance. Skewness is 0.3605 (right skewed or with positive skewness) and kurtosis is 3.3513 indicative of a Leptokurtic distribution. These characteristics satisfy a typical eye blink waveform.

III. WAVELET OPTIMIZATION AND DETECTION PROCEDURES

A. Wavelets

Wavelets are a class of mathematical functions used to localize a given continuous- or discrete-time function in both space and scaling. A family of wavelet can root from a mother wavelet [13]. The mother wavelet function is defined as $\Psi(t) \in \mathcal{L}^2(\mathbb{R})$, which is limited in a finite interval. The function is defined and has values in a certain range and zeros elsewhere. The mother wavelet has zero-mean and it is normalized. Mathematically, they are

$$\int_{-\infty}^{+\infty} \Psi(t) dt = 0 \quad (4)$$

$$\|\Psi(t)\|^2 = \int_{-\infty}^{+\infty} \Psi(t)\Psi^*(t) dt = 1 \quad (5)$$

Dilation and translation property states that the mother wavelet can form a basis set of value denoted by

$$\left\{ \Psi_{u,s}(t) = \frac{1}{\sqrt{s}} \Psi\left(\frac{t-u}{s}\right) \right\}_{u \in \mathbb{R}, s \in \mathbb{R}^+} \quad (6)$$

where u is the translating parameter, indicating which region is concerned. The variable s is the scaling parameter. It should be greater than zero because negative scaling is undefined. The term $\frac{1}{\sqrt{s}}$

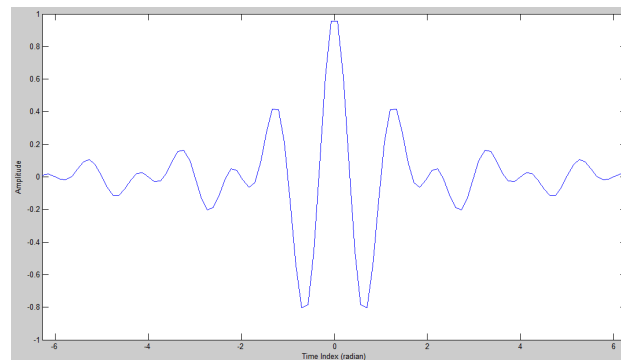

Fig. 5. Sinc (Shannon) wavelet.

is for energy normalization, that is, to achieve the same energy level at every scale.

In this paper, the Sinc wavelet, commonly known as the Shannon wavelet, was used. The Sinc wavelet is the second fundamental of the wavelet systems [14]. This is defined by

$$\Psi(t) = 2\text{sinc}(2t) - \text{sinc}(t) \quad (7)$$

with a trigonometric equivalent in terms of the sine function defined by

$$\Psi(t) = \frac{\sin(2\pi t) - \sin(\pi t)}{\pi t} \quad (8)$$

Two parameters were considered to best fit the waveform as described in Equation (6). These parameters are the translating parameter and the scaling parameter. It is recommended to take special values for s and u : $s = 2^{-j}$ and $u = k2^{-j}$ where j and k are integers. Both of these values were optimized to best fit the waveform as shown in Fig. 4. However, this assignment of recommended values is not strictly observed in this paper.

Wavelets should integrate to zero and waving above and below the x-axis as shown in Fig. 5. The graph shows a direct implementation of the Shannon wavelet as described in Equation (7) with a range of $-2\pi \leq t \leq 2\pi$ spaced with 128 discrete indexes.

B. Genetic Algorithm

Genetic algorithm is an optimization method used to solve both constrained and unconstrained problems using a process similar to biological evolution. This is a repeated process that selects individuals at random from the current population to be parents

used to produce children for the next generation. As the process repeats, the population evolves toward an optimal solution.

The genetic algorithm was used to best match the marked eye blink signal. A fitness function [8] defined by Equation (9) was fed into the Optimization toolbox using genetic algorithm in MATLAB. The trapezoidal method of numerical integration was used in order to calculate the least area between the CWT coefficients of the marked eye blink signal and the optimized Shannon wavelet above the x -axis.

$$f(u, s) = \int |x(t) - \Psi_{u,s}(t)| dt \quad (9)$$

Three variables were used in the process of obtaining the scaling (s) and translating (u) parameter of the wavelet basis function. In this paper, s and u are defined as follows:

$$s = 2^{-j}(k\pi) \quad (10)$$

$$u = ls \quad (11)$$

where j , k , and l are the optimized unknown variables.

The GA was implemented with a double vector population type and a population size of 20. The number of generations was set to 100. The stopping criterion is not dependent on time limit or with the stall time limit. The rest are set as default.

C. Detection with Wavelets

The optimized wavelet was used to search the occurrences of eye blinks through an entire EEG stream. Once an eye blink was found, a counting algorithm takes place to determine the total number of eye blinks. The correlation coefficient of the optimized wavelet and the CWT coefficients of EEG waveform was used as a determining parameter.

The search process was done by calculating the wavelet transform of the whole signal, and then obtaining the wavelet coefficients along a determined scale [8], in this case, 128 samples per frame. The correlation between the coefficients of the optimized wavelet and the wavelet transform of the EEG signal was obtained every 128 samples, giving 60 coefficients. Whenever the correlation coefficient is greater than the threshold value, a unit is counted. The threshold coefficient value was obtained using shape language modeling or SLM [15].

TABLE I
GA OPTIMIZATION RESULTS

Run	j	k	l	fit
1	1.608	0.541	-2.158	21.253
2	2.624	1.050	-2.253	21.263
3	1.218	0.407	-2.185	21.115
4	3.017	0.224	-0.903	21.661
5	3.395	1.749	-2.261	21.091
6	2.471	0.915	-2.306	21.129
7	0.276	1.097	-3.700	16.528
8	4.708	0.117	-0.150	20.758
9	0.544	0.249	-2.181	21.318
10	0.021	0.010	-0.138	21.352

IV. RESULTS

A 10-run GA was implemented and the coefficients with the three lowest fitness function value was considered. As a general rule, the lower the fitness value, the greater is the similarities of the waveforms. Table I shows the results of the run.

Runs 7, 8, and 5 were found to have the top 3 lowest fitness values. Run 7 obtained the least value of the fitness function with 16.528 using the coefficients $j = 0.276$, $k = 1.097$, and $l = -3.700$. Using equations (10) and (11), $s = 2.846$ and $u = -10.531$. Run 8 obtained the second least value of the fitness function with 20.758 using the coefficients $j = 4.708$, $k = 0.117$, and $l = -0.150$ obtaining $s = 0.014$ and $u = -0.002$. Thirdly is Run 5 with a fitness function value of 21.091 using the coefficients $j = 3.395$, $k = 1.749$, and $l = -2.261$ obtaining $s = 0.522$ and $u = -1.181$.

The graphs of the waveforms (in red) of the three runs are shown in Fig. 6. They were plotted together with the CWT coefficients of the marked eye blink signal. Their statistical characteristics are shown in Table II.

Wavelets should integrate to zero and waving above and below the x -axis. If the x -axis will be translated by 0.5 above zero, then the wavelets in Runs 8 and 5 (Fig. 6b and 6c) satisfy the aforementioned condition. Run 7 may also be waving but it is not that noticeable as compared with the other two.

However, looking at the statistical characteristics of the waveforms in Table II, the wavelet in Run 7 satisfies the condition in the kurtosis method. Wavelets in Runs 8 and 5 have very high peakedness which if made to run through an EEG stream may

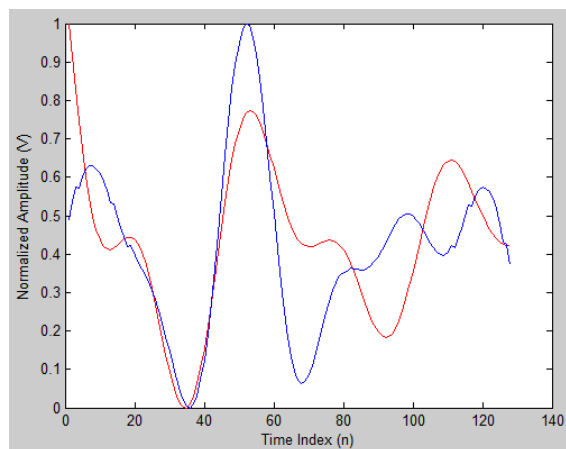

(a)

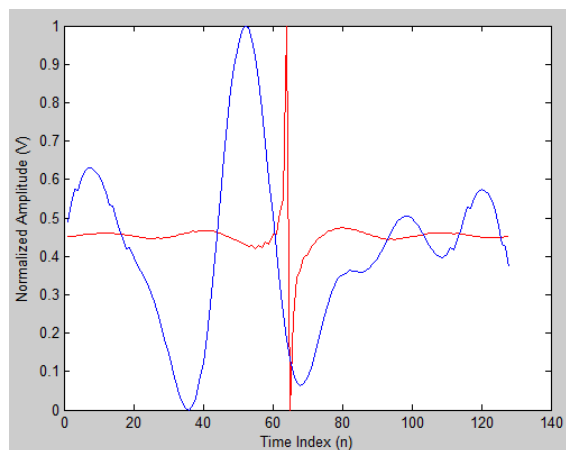

(b)

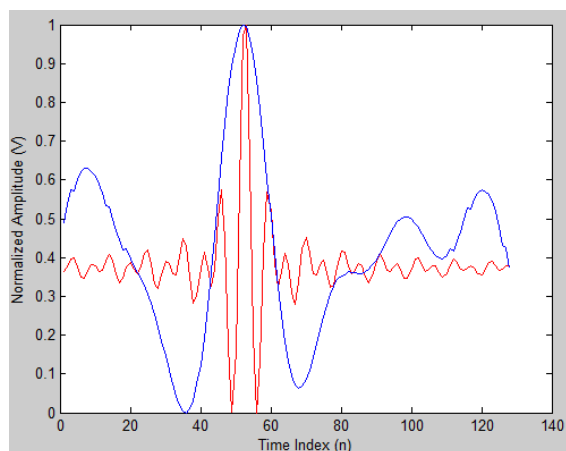

(c)

Fig. 6. Optimized wavelet with the marked eye blink signal: (a) Run 7, (b) Run 8, (c) Run 5.

TABLE II
STATISTICAL CHARACTERIZATION OF THE OPTIMIZED
WAVELETS

Wavelet	Expectance	Variance	Skewness	Kurtosis
Ref	0.422	0.050	0.361	3.351
Run 7	0.434	0.040	-0.047	2.973
Run 8	0.451	0.005	1.542	47.535
Run 5	0.379	0.121	2.039	18.062

indicate other high peak signals aside from an eye blink.

The genetic algorithm performance for the three runs is shown in Fig. 7. This paper looked upon the following plot functions in the GA Toolbox: Best Fitness, Best Individual, Distance, and Selection. The Best Fitness plots the best function value in each generation versus the iteration number. The Best Individual plots the vector entries of the individual with the best fitness function value in each iteration. The Distance plots the average distance between individuals at each generation and the Selection plots a histogram of the parents. This basically shows which parent is contributing to each generation.

Three variables were optimized to determine the least possible value of the fitness function as defined by Equation (9). At the end of each run, the best value of the fitness function is displayed. Table I shows these results. It can also be seen that the average distance between individuals are becoming smaller as they approach the optimum fitness value. Parent 2 contributes significantly as each generation progresses to the optimum.

A sample EEG signal is shown in Fig. 8. This EEG stream contains 24 manually marked eye blinks. The kurtosis method counted 21 eye blinks while when the optimized wavelet was made to run through this stream, the eye blink count is 23.

The result of the eye blink detection and counting is shown in Table III. Three counting methods were presented in this study. The manual counting (M) was performed by simply looking for the spikes in the EEG signal and observing it hand-in-hand with a video footage. The kurtosis method (K) was done as described in Section II-B while the wavelet method (W) was performed as described in Section III-C.

To compare the counting results obtained in Table III, the percentage difference (PD) between them is calculated. As a rule, the smaller the PD, the

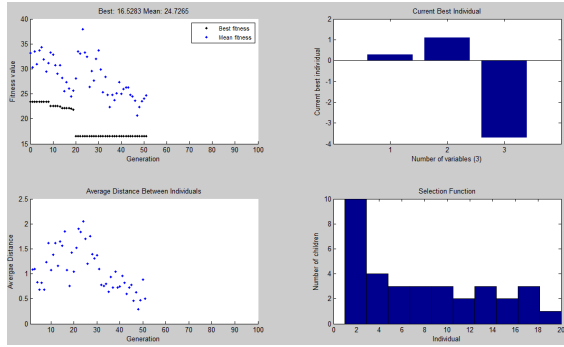

(a)

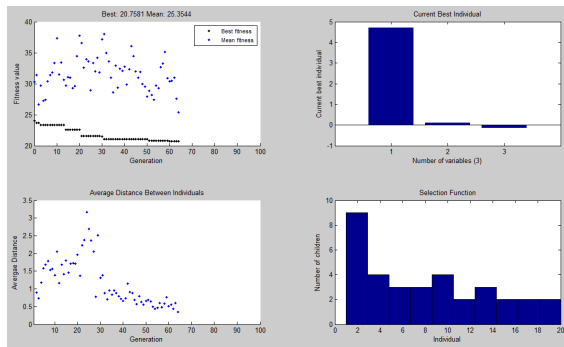

(b)

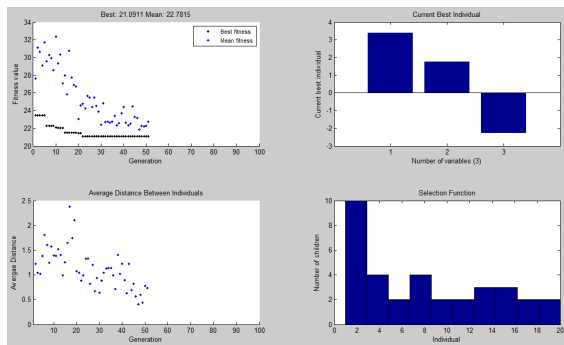

(c)

Fig. 7. GA Performance: (a) Run 7, (b) Run 8, (c) Run 5.

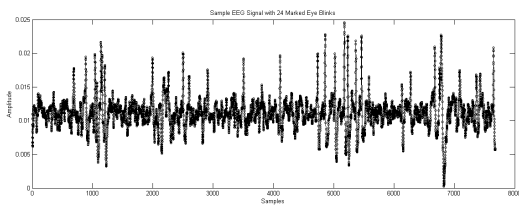

Fig. 8. Sample EEG signal with 24 marked eye blinks.

closer are the quantities being compared. The PD

TABLE III
EYE BLINK COUNTING RESULTS

EEG Sample	Count		
	Manual (M)	Kurtosis (K)	Wavelet (W)
1	24	21	23
2	22	19	29
3	25	25	27
4	26	20	25
5	23	14	30
6	35	16	31
7	28	14	30
8	29	22	29
9	34	21	26
10	34	17	31
11	22	21	32
12	31	18	28

TABLE IV
PERCENTAGE DIFFERENCES BETWEEN M, K, AND W

EEG Sample	Percentage Difference		
	M vs. K	M vs. W	K vs. W
1	13.33	4.26	9.09
2	14.63	27.45	41.67
3	0.00	7.69	7.69
4	26.09	3.92	22.22
5	48.65	26.42	72.73
6	74.51	12.12	63.83
7	66.67	6.90	72.73
8	27.45	0.00	27.45
9	47.27	26.67	21.28
10	66.67	9.23	58.33
11	4.65	37.04	41.51
12	53.06	10.17	43.48
Average	36.92	14.32	40.17

calculation results are shown in Table IV. On the average, the manual counting versus the counting method using wavelets have the least percentage difference of 14.32%. What the wavelet method counts is much closer to the manual observation of the eye blink spikes. The manual counting versus the kurtosis method comes next with 36.92%. This indicates that if the kurtosis and wavelet methods are compared, the wavelet method counts better than the kurtosis method. If the kurtosis and the wavelet methods are compared, their percentage difference is 40.17% which means that they are counting eye blinks similarly at 59.83%.

Table V shows the statistical analysis of the counting results between the three methods used. To analyze the three counting methods, a single

factor ANOVA (Analysis of Variance) was used. The null hypothesis states that there is no significant difference between the counting results of the three methods. Alternatively, there is a significant difference. The level of significance is 0.05. The decision rule holds that if the F-computed value (or F) is greater than the tabular value (F crit), disconfirm the null hypothesis.

From Table V, the F value is 23.815 which is found to be greater than the F crit with 3.285. With this, it is safe to conclude that there is enough evidence to state that there is a significant difference between the counting results of the three methods.

To statistically determine if there is a significant difference between the counting results of the Kurtosis and Wavelet methods, the t-test with assumed equal variances was used. Similarly, the null hypothesis states that there is no significant difference between the results of Kurtosis and Wavelet eye blink counting methods. Alternatively, there is a significant difference. The decision rule holds that if the t-computed value (or t Stat) is beyond the tabular value (t Critical), disconfirm the null hypothesis. The level of significance is also set at 0.05.

From Table VI, the t Stat value is -7.595 which is found to be beyond the t Critical with 1.717 (for one-tail) and 2.074 (for two-tail). From these results, for both one-tail and two-tail, it is safe to state that there is enough evidence to conclude that there is a significant difference between the counting results of the two methods. This supports the validity of the PD calculations and the effectiveness of the wavelet-based counting method over the kurtosis-based method.

As for the number of eye blink count per method used, the wavelet method shows the highest percentage in the rank with 38%. Seconded by the manual counting with 37%; then the kurtosis method with 25%. The wavelet method shows a closer proximity with the manual method in eye blink counting. Fig. 9 shows the pie chart of the eye blink count distribution.

V. CONCLUSION

In this paper, genetic algorithm was used to design and optimize a wavelet to specifically detect an eye blink signal in an EEG stream. The continuous wavelet transform (CWT) coefficients of the marked

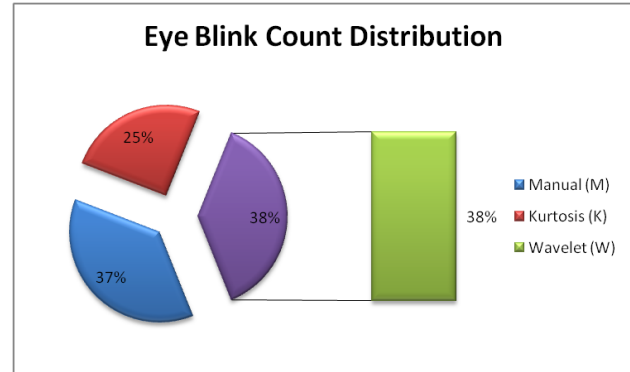

Fig. 9. Eye blink count distribution.

eye blink signal served as the basis for the formation of the designed wavelet which is rooted from the Shannon wavelet. The optimized wavelet was used to search through the EEG stream for the purpose of counting the number of eye blink signals present in it. The fitness function plays an important role in the optimization process. The fitness function was defined by the difference of the areas under the curve and implemented using trapezoidal method of numerical integration. Parameter matching was done so that the wavelet appears to be more like the desired waveform. Three parameters were considered in the optimization process that are contributory to the translating and scaling coefficients of the mother wavelet.

Three results came with the top three lowest fitness function value. However, due to some constraints, the one with the lowest kurtosis value was considered. This is to best match with the kurtosis value of a typical eye blink signal. The obtained wavelet was made to run through the EEG stream for counting.

Three methods were considered: manual, kurtosis-based, and wavelet-based. As compared with the kurtosis-based method, the wavelet-based counting method was proven to count eye blinks closer to the manual counting. The percentage difference between the methods was calculated in order to come up with this comparison. Moreover, the wavelet method also shows the largest count of eye blinks but this is not so far with the manual counting. The kurtosis method counts the least and is found to be far from the manual count.

Statistically, there is a significant difference when

TABLE V
ANALYSIS OF VARIANCE FOR THE M, K AND W METHODS

Source of Variation	SS	df	MS	F	P-value	F crit
Between Groups	662.722	2.000	331.361	23.815	0.000	3.285
Within Groups	459.167	33.000	13.914			
Total	1121.889	35.000				

TABLE VI
T-TEST FOR THE K AND W METHODS

t Stat	-7.595		
	one-tail		two-tail
P(T ≤ t)	0.000	P(T ≤ t)	0.000
t Critical	1.717	t Critical	2.074

all the three counting methods were considered. Results are shown in Table IV. When the Kurtosis-based method was compared with the Wavelet-based method, it was found out that they have a significant difference as shown in Table V. This supports the results of the PD calculations and proves its consistency.

The GA-optimized wavelet-based counting method can be used to count eye blinks in electroencephalograms (EEG). The waveform which has to be detected in an EEG stream may appear differently which indicates a variation in the wavelets fitness characteristics. Other wavelets may also be considered and optimized in search for other features in an EEG stream.

REFERENCES

- [1] M. Haak, S. Bos, S. Panic, and L. Rothkrantz, "Detecting stress using eye blinks and brain activity from EEG signals," *Proceeding of the 1st Driver Car Interaction and Interface (DCII 2008)*, pp. 35–60, 2009.
- [2] Better Medicine, "Eye blinking symptoms," 2011, Retrieved 2013-07. [Online]. Available: <http://www.localhealth.com/article/eye-blinking-symptoms>
- [3] L. Shoker, S. Sanei, and M. A. Latif, "Removal of eye blinking artifacts from EEG incorporating a new constrained bss algorithm," in *Sensor Array and Multichannel Signal Processing Workshop Proceedings, 2004*. IEEE, 2004, pp. 177–181.
- [4] M. A. Sovierzoski, F. I. Argoud, and F. M. De Azevedo, "Identifying eye blinks in EEG signal analysis," in *Information Technology and Applications in Biomedicine, 2008. ITAB 2008. International Conference On*. IEEE, 2008, pp. 406–409.
- [5] D. G. Manolakis, V. K. Ingle, and S. M. Kogon, *Statistical and Adaptive Signal Processing: Spectral Estimation, Signal Modeling, Adaptive Filtering, and Array Processing*. Artech House Norwood, 2005, vol. 46.
- [6] W. B. Mansor *et al.*, "Detection of eye blinks from EEG signals for home lighting system activation," in *Mechatronics and Its Applications, 2009. ISMA'09. 6th International Symposium On*. IEEE, 2009, pp. 1–4.
- [7] B. Chambayil, R. Singla, and R. Jha, "EEG eye blink classification using neural network," in *Proceedings of the World Congress on Engineering*, vol. 1, 2010, pp. 2–5.
- [8] Z. Haydari, Y. Zhang, and H. Soltanian-Zadeh, "Semi-automatic epilepsy spike detection from EEG signal using genetic algorithm and wavelet transform," in *Bioinformatics and Biomedicine Workshops (BIBMW), 2011 IEEE International Conference On*. IEEE, 2011, pp. 635–638.
- [9] J. Azcarraga and M. T. Suarez, "Recognizing student emotions using brainwaves and mouse behavior data," *International Journal of Distance Education Technologies (IJDET)*, vol. 11, no. 2, pp. 1–15, 2013.
- [10] Emotiv Wiki, "Emotiv EPOC," Retrieved 2013-06. [Online]. Available: http://emotiv.wikia.com/wiki/Emotiv_EPOC
- [11] H. Ekanayake, "Research use of the emotive EPOC," 2011, Retrieved 2013-07. [Online]. Available: http://neurofeedback.visaduma.info/emotivresearch_o.htm
- [12] S.-S. Poil, "Bad channel rejection - kurtosis - threshold limits default 5," 2013, Retrieved 2013-06. [Online]. Available: <http://sccn.ucsd.edu/pipermail/eeglablist/2013/006257.html>
- [13] E. W. Weisstein, "Wavelet," Retrieved 2013-06. [Online]. Available: <http://mathworld.wolfram.com/Wavelet.html>
- [14] K. Cheng and E. Gregory, "Example wavelets," 2005, Retrieved 2013-07. [Online]. Available: <http://cnx.org/content/m11150/latest/>
- [15] J. D'Errico, "SIm—shape language modeling," 2009, Retrieved 2013-07. [Online]. Available: <http://www.mathworks.com/matlabcentral/fileexchange/24443>

Hybrid Fuzzy Multi-criteria Decision Making: Exploring Decisive Green Purchasing in Customer Relationship Management

Chun-mei Su, Der-Juinn Horng, Ming-Lang Tseng, and Anthony SF Chiu

Abstract—This study contributes to the impact of customer relationship management (CRM) on customer purchase intention related to green products from the perspective of firms in Taiwan's food industry. Due to an increasing awareness of environmental effects, customers are more sensitive towards green products when making purchasing decisions. Consequently, food companies must understand and be aware of the effect of their green products on purchasing intention in their CRM model. Thus, this study focuses on CRM and green purchasing aspects for consumers' purchase intention of green products, which continues to have shortcomings. This study identifies the debates, integrates the theory of planned behavior, and proposes to use the fuzzy Delphi method, fuzzy set theory, and importance-performance analysis. The primary finding is that a person's effects, intention, and technology are significant to stimulate customer intention related to the purchase of green products.

Index Terms—customer relationship management, theory of planned behavior, fuzzy Delphi method, fuzzy set theory, importance-performance analysis.

I. INTRODUCTION

THE food industry is contributing to Taiwan's national economy. It is a dynamic industry, with constant changes in customer demands. During this decade, consumers have increasingly paid attention to green purchasing and environmentally

conscious products [1], [2], [3]. Da Cunha Lemos and Giacomucci stated that green purchasing is the act of buying products or using services that can reduce harmful impacts on the environment [4]. The growth in demand for green products has been increasing due to food scandals that have heightened consumers' awareness of natural, healthy, safe, and high-quality food along with their purchasing intention (PI) towards green products [5]. Hallstedt et al. suggested that sustainability must be integrated into organizational goals because green products orient firms towards sustainability [6]. In addition, customer relationship management (CRM) can facilitate and influence customer PI towards green products. Prior studies of the CRM model have derived many different but closely related CRM characteristics, which generally are categorized into three complementary perspectives: technology, business, and customers [7]. The CRM model plays a key role in business management for sustainable business development [8]. Thus, according to theories of customer behavior, firms must integrate the CRM model as a solution for obtaining purchases from customers.

This study integrates customer behavior theories, including the theory of planned behavior (TPB), and suggests that a customer's response to an offering from a firm is usually well reasoned and clearly manifested in their intention and behavior. Moreover, the CRM model can be explained by the TPB, which is concerned with the determinants of consciously intended behavior [9], [10]. There are studies that have discovered the role of CRM aspects in several industries [11], [12], [13], [14]. Carter argued that the CRM model is a critical factor that directly influences green purchasing and the firm's understanding of customer behaviors [15]. Nevertheless, the studies

C. Su a Ph.D. candidate in Management at the National Central University, Taiwan

D. J. Horng is with the Business Administration Department, National Central University, Taiwan

M. L. Cheng is with the Business Administration Department, Lughwa University of Science and Technology, Taiwan

A. SF. Chiu is with the Industrial Engineering Department, De La Salle University, Manila, Philippines

that have a detailed focus on the CRM model and green purchasing aspects of PI towards the food industry continue to have shortcomings. Therefore, this study aims to enrich understandings about CRM impacts on green purchasing in the food industry.

This study illustrates how the CRM model integrates into customer PI towards green products. This study's contribution is to provide an understanding of the CRM aspects that specifically focus on customers' PI towards green products from the perspective of firms in Taiwan's food industry. Through aspects and criteria collected from the literature and some industry experts, this study measures three perspectives (technology, customer orientation, and business) on green purchasing and allows firms to explicitly determine the range of their importance in a competitive market along with their effects on organizational performance, so that they can benchmark their sustainable competitive advantages.

Studies of the CRM model have applied the model in different fields and used traditional statistical methods to measure it [16], [17], [11], [18]. The prior studies usually generate a set of aspects and criteria and therefore eliminate unnecessary aspects and criteria in reliance on experts' experience and knowledge. Still, experts' experience and knowledge are usually vague and subjective. The prior studies failed to express their responses in qualitative preferences. Thus, Karsak utilized the fuzzy Delphi method (FDM) to achieve a customer consensus in determining the importance of customer needs [16]. Nasserzadeh et al. applied FDM to simulate and represent the factors that affect customer satisfaction [17]. Additionally, the fuzzy set theory resembles reasonable human action through approximate information and uncertainty to generate intentions. Because one of the advantages of FDM is simplicity, in which all linguistic terms are transferred into fuzzy numbers and all of the expert opinions can be encompassed within one investigation, this method can generate a better effect of criteria selection [19]. In addition, importance and performance are two elements that play key roles in customer intention analysis [20]. Thus, this study uses FDM to eliminate aspects and criteria and utilizes importance-performance analysis (IPA) to determine the criteria important for discovering CRM model impacts on green purchasing.

Thus, this study's objective is to identify a set of aspects and criteria and to benchmark the critical aspects and criteria under uncertainty. The study is organized as follows: Section 2 provides and develops a theoretical evaluation of green purchasing from a firm perspective and reviews literature on its aspects and criteria. Section 3 presents the method and data analysis, which involves FDM and IPA. The results are discussed in details in section 4. This discussion is a hierarchical model in which the aspects and criteria are presented. Section 5 presents the theoretical and managerial implications. The final section illustrates conclusions, contributions, limitations, and future studies.

II. LITERATURE REVIEW

In this section, the definition and perspectives of the CRM are explicitly presented. In addition, the TPB is provided to understand PI and green purchasing. The final section presents the method and measurement.

A. Customer Relationship Management

The CRM model is a business strategy that aims to establish and develop the value-creation relationship with the customer base with respect to understanding, anticipating, and managing customer needs along with the knowledge that is gained about the customer to improve organizational effectiveness and increase profitability [21]. One of the primary goals of many companies is to create superior value for the customer [22]. Furthermore, Coner and Gungor stated that capturing customer behavior is a significantly important element in meeting the customer requirements [23].

CRM has existed in many different concepts; but generally, it is categorized into three perspectives: technology, business, and customers. Becker et al., found two forms of CRM [24]. The first is based on the organization's capability to foster a relationship with the customer that relates to service marketing. The second uses technology to collect data so that through data analysis, the firm can optimally satisfy customers' needs and thereby generate long-term, loyal relationships with them. In the following sections, this study discusses the three perspectives in detail.

1) *Technology Perspective:* From a technological perspective, information technology is regarded as a key component in implementing a business strategy that allows the collection and analysis of customer information to foster closer customer relationships [25]. Chalmeta stated that the technology perspective on CRM provides an organization with numerous benefits because that system not only helps the firm to improve the effectiveness of the processes involved in customer relationships but also helps the firm to respond very quickly to changes in the environment and customer needs [26]. Therefore, it is essential for an organization to require an integrated information system that provides accurate, real-time, and relevant customer information to all employees [27]. Moreover, to successfully implement the CRM, the firm must apply the right technology with which to optimize the business processes involved in the customer relationship. This information system is used in the organization's marketing, sales, and service functions [28].

2) *Business Perspective:* Analyzing the aspects that belong to business perspective is very important because the results of such research affects decision-making related to creating appropriate strategies to satisfy customer requirements [29]. Hayes and Ref stated that the business perspective recognizes CRM related to customer demographics, understanding and predicting consumer behavior, segmenting customers, and analyzing purchasing patterns [30]. Moreover, CRM helps employees to access the accuracy of information so that they can best respond to customer needs during customer interactions. Kotorov recognized that to successfully execute CRM, the firm must restructure its organization and orient its value chain to demand [31]. Thus, the business perspective includes the transformation required by the organization's business processes, structure, and culture [32]. Goodhue et al. argued that to optimize the benefits of CRM, it is not sufficient for the firm simply to base it on applying an integrated information system; instead, the firm must change job roles, business processes, and organizational culture [33].

3) *Customer Perspective:* Anderson and Kerr defined the CRM model from the customer perspective as concentrating on making contact between the customer and the organization [34]. Customers usually do not pay attention to a firm's internal business;

however, they are affected by their interactions with the firm. There are many types of interaction, such as call centers, communication channels, email, sales representatives, faxes, and others [35]. Therefore, service efficiency and friendliness to customers are considered as important elements that help organizations to maintain customers, avoiding the unwanted situation of having customers reject firm because of poor services or interactions [36]. Massey found that customer loyalty is established through customer interaction [37]. The explanation for this phenomenon is that when employees spend more time to communicate with customers, they realize that customers are willing to spend time to interact with the organization. Through CRM, it is essential for organizations to understand customer requirements; therefore, employees who directly interact with customers should be provided an overview of customer information that could help them to improve customer services [33]. Carter stated that CRM has a direct impact on firms' green purchasing and their investigation of customer behavior that can affect green purchasing [15]. Therefore, the concept of green purchasing is presented clearly in the next section.

B. Green Purchasing

Chang and Cheng stated that a significant increase in environmental issues accompanies the development of human society [38]. Thus, green purchasing has become an important force that can protect the environment and save the earth [39]. Min and Galle defined green purchasing as the purchase of goods and services that minimize environment impacts [40]. This includes the purchase of products that have "lesser or reduced effects on human health and the environment when compared with competing products that serve the same purpose". The factors for comparison include raw materials such as the energy and water used in the manufacturing process; types of production, packaging, and distribution; source reduction and reuse; transport distance; and local production [41]. These elements combine into a single product that can fit the green-product standard and that causes organizations to pay more attention when sending their products to market to compete at the best price. In addition, Preuss defined green

purchasing as an effective way to improve industries' environmental performance [42].

Liere and Dunlap showed that environmental concerns and human motivational factors such as age, education, and political ideology are closely related [43]. In addition, these authors also state that well-educated people seem to have more environmental awareness. Moreover, Lee identified key factors that affect consumers' green purchasing behavior, such as social influence, environmental concern, self-image, and perceived environmental responsibility [44]. Whereas Straughan and Roberts have found that the level of knowledge has a strong impact on people's ecological and environmental attitudes [45], Bonini and Oppenheim have discovered that environmental knowledge has an impact on purchasing behavior based on their study of consumers' belief toward green attitudes [46]. Additionally, the affect of individuals' knowledge and intention related to the environment are determined by their value evaluations [47], [39]. Some researchers use variables to describe people's actions toward environmental issues. For example, Kalafatis et al. have examined the factors that affect consumers' intention to buy green products and have indicated that the TPB offers a straight, defined structure that allows an investigation of the influence that various factors have on consumers' intentions to buy green products [48].

Research on green purchasing has involved applying established theories, most commonly those based on the TPB [49]. That theory states that consumers' attitudes and norms related to environmental matters strongly determine their actual behaviors and green purchasing actions. TPB stated that PI is a crucial element that can determine customers' actual buying behavior. More specifically, the stronger the customer intentions related to green products, the more purchases made by the customer and thus, there is a strong link between green purchasing and PI.

According to Beckford et al. [50], PI is a significant predictor of green purchasing behavior, which means that PI positively affects the probability of a customer decision. PI is a customer's objective when making a decision whether to purchase a product [51]. In addition, it is a reason that gives customers greater motivation to purchase, a type of cognitive good. TPB also explains that PI is the key

factor in purchase behavior, which is influenced by customer's attitudes [52]. Furthermore, to have better PI prediction, attitudes towards behavior are more important than attitudes towards products [52].

Carter argued that CRM is a key factor that directly influences green purchasing activities and the firm's understanding of customer behaviors [15]. Furthermore, Ajzen has stated that PI is a crucial element that can determine a customer's green buying behavior [49]. However, there is a lack of studies with a detailed focus on CRM aspects and PI towards green purchasing in the food industry, especially in terms of green food products. This study's findings explicitly describe the link among these three factors and provide an understanding of the effect of CRM perspectives that specifically focus on the customer's PI related to green purchasing efforts.

C. Method

This study measures the importance and effectiveness of each criterion to the firm's CRM perspectives by integrating FDM to eliminate unnecessary criteria, to enhance resources efficacy, and to implement the IPA evaluation tool.

FDM has been used in many studies [53], [54], [55], [19]. Karsak has utilized the FDM to determine the importance of customer needs to the firm [16]. Nasserzadeh et al. has also applied FDM to simulate and represent the factors that affect customer satisfaction [17]. FDM, which was first developed by Dalkey and Helmer [56], is a technique used to obtain the most reliable concurrence among a group of experts [57]. The advantages of this method, compared to others, are that the participants avoid direct confrontations and have opportunities to receive feedback reports, thus improving their own opinions [17], [58]. In addition, Kaufmann and Gupta have proposed another, more complete FDM procedure, which uses the fuzzy set theory by asking participants to provide an estimate [59].

After removing unnecessary aspects and criteria that do not have a significant effect on CRM, this study uses the IPA model to analyze the importance and performance of the remains. The IPA model was first introduced by Martilla and James [60]. Pezeshki et al. have integrated IPA as a mainstream method to investigate the importance and performance of

the criteria from the customer perspective and determined that the importance of an attribute is a function of the performance of that attribute [20]. IPA is essential to judge decisions that reduce the acknowledgement of priority improvements in accordance with strategic planning to strengthen competitiveness [61]. IPA is also a behavioral theory used as a means to assert management decisions about the method of responding to a specific management problem.

D. The Measures

The construct of green purchasing and CRM has been measured according to four perspectives: green purchasing, technology, customers, and business. These perspectives include nine aspects: effect, knowledge, intention, actual purchase, CRM technology, customer orientation, performance, value drivers, and marketing metrics.

The effect measures are presented in Table 1. The firm clearly recognizes a significant change in customer attitudes towards environmental products over time. Attitudes are the most suitable way to explain that the customer is willing to be involved in, to purchase, and to fulfill ecological objectives [62]. It frightens the customer to imagine using a product that harms the environment. In addition, the balance of nature is disrupted by human activity; therefore, people should take responsibility and make an effort to improve environmental issues because humans are the primary cause of environmental damage. Lee identified environmental concern and environmental responsibility as the essential factors that affect green purchasing behavior [44].

From the ecological knowledge perspective, some factors that cause soil pollution and are the primary cause of the death of ocean creatures include knowledge that customers need to have about the environment. Furthermore, all of the lead pollution in the atmosphere is caused by humans. Thus, it is most important that they obtain more knowledge about a solution that helps to improve the environmental atmosphere. Bonini and Oppenheim have studied consumers' beliefs related to green attitudes, and they stated that ecological knowledge has an important effect on green purchasing behavior, particularly with respect to products that receive more attention, such as recycled products and vehicles [63].

Additionally, Ajzen has applied the TPB to offer a clearly determined structure that allows research about the factors that affect consumers' intentions to purchase environmental friendly products [49]. The customer is aware that he or she always avoids purchasing products that are potentially harmful to the environment. For instance, if they have to choose between two similar products, they will choose the one that is friendlier to the environment. Moreover, customers make a special effort to purchase paper and plastic products made from recycled materials. Conversely, some customers do not pay attention to or consider environmental issues when they make a purchase. Thus, the measures of PI included five criteria.

Actual purchases relate to the customer's intention in green purchasing. Jang et al. (2008) have explained that customers present their feelings when using green products, that green products play a large role in helping the environment and that green products feel more comfortable than non-green products [64]. Moreover, after the first time using environmental product, a customer has intention for repeat purchases and would like to recommend the product to friends and family [39]. This shows that if quality of a green product is good enough, the customer is willing to accept and purchase it. Otherwise, some customers indicate that they do not consider the environment and that their experience with green products does not change their beliefs.

Technological perspective has been mentioned as a capability that allows organizations to encourage closer relationships with customers, to analyze customer information and to provide a consistent view of the customer [33]. Sin et al. stated that CRM software and hardware systems allow firms to offer customer service of higher quality but lower cost [25]. Consequently, to optimize the business processes involved in customer relationships, the firm must apply the proper technology [26]. Moreover, with CRM technology, individualized information about each customer is available at all points of contact and the firm has the ability to consolidate all of the customer information that it acquires in a comprehensive, centralized, updated database.

Customer orientation was measured using seven criteria from Narver and Slater's study [65]. Customer orientation implies unequivocally placing the

customer at the center of all of an organization's activities to steadily build long-term relationships [66]. The business's objectives are oriented towards customer satisfaction so that understanding and fulfilling customer needs are considered as the firm's competitive advantage. Furthermore, the firm must offer personalized products and services to help the key customer obtain greater satisfaction and thus become more loyal. Therefore, Bentum and Stone stated that customer orientation is the most important, indispensable element for the successful implementation of CRM [66].

CRM performance related to CRM objectives has been adopted by Srivastava et al. [67]. A firm's CRM performance is presented in terms of behavior such as repeat purchases and cross selling [68]. Relationship quality based on CRM performance is explained through customer satisfaction and customer loyalty [69]. Moreover, some criteria, such as sales distribution, low-cost customer services, and promotional programs, are mentioned in terms of the efficiency basis of CRM performance. In value terms, Hirschowitz has stated that higher shares of profitable customers are a factor in CRM performance [70].

Value drivers are mentioned in relation to seven criteria. Stevens and Chonko stated that improving sales force efficiency and effectiveness has long been the goal of selling organizations [71]. The sales force benefits from CRM through improved value and brand equity in the initiation stage and improved value, brand, and relationship equity in the maintenance stage. In addition, CRM supports better pricing decisions by increasing a firm's ability to understand customers' requirements and to adjust prices accordingly. In addition, customer service is the most important function in an organization, providing an important source of contact with customers. Therefore, CRM designed to provide support for customer service personnel should be improved to upgrade customer services [72].

Hirschowitz has highlighted the marketing metrics that survey the effectiveness of CRM activities by collecting data on marketing campaigns, channels, treatments, and customer responses [70]. In terms of consumer behavior responses, ordering higher-value categories, ordering different product lines, and increasing order sizes are measured. Ratings of the

firm as a reliable partner and opinions of the firm as a long-term partner are criteria for the consumer intermediate responses term. With respect to the term of direct customer responses, the criteria include frequent communication and improved relationship quality, which are mentioned as factors that affect the marketing metric for CRM. With respect to the term of innovativeness responses, involvement in new product development is measured.

III. METHOD

This section presents the method applied in this study. The proposed methods are FDM, fuzzy set theory, and IPA. These methods have different characteristics for the specific purpose of evaluating solutions.

A. Fuzzy Delphi Method

This study used FDM to screen alternate factors at the first stage. The fuzziness of experts' common understanding could be solved by using the fuzzy theory and evaluated on a more flexible scale. The efficiency and quality of questionnaires could be improved [77].

A fuzzy set \tilde{A} in a universe of discourse X is characterized by the membership function $\mu_{\tilde{A}}(x)$ which assigns each element x in X a real number in the interval $[0,1]$. The numerical value $\mu_{\tilde{A}}(x)$ stands for the grade of membership of x in \tilde{A} [78]. Table 1 presents the corresponding interval-valued TFNs with linguistic preferences.

Definition 1: A TFN \tilde{a} is defined by a triangular $\tilde{a} = (a_1, a_2, a_3)$ with membership function

$$\mu_{\tilde{A}}(x) = \begin{cases} 0 & \text{if } x < a_1 \\ \frac{x-a_1}{a_2-a_1} & \text{if } a_2 \geq x \geq a_1 \\ \frac{a_3-x}{a_3-a_2} & \text{if } a_2 \geq x \geq a_3 \\ 0 & \text{otherwise} \end{cases} \quad (1)$$

Definition 2: Let $\tilde{a} = (a_1, a_2, a_3)$ and $\tilde{b} = (b_1, b_2, b_3)$ be two TFNs, where $a_1 \leq a_2 \leq a_3$ and $b_1 \leq b_2 \leq b_3$ the distance between \tilde{a} and \tilde{b} can be calculated as:

$$\delta(\tilde{a}, \tilde{b}) = \sqrt{\frac{1}{3} \left[(a_1 - b_1) + (a_2 - b_2) + (a_3 - b_3)^2 \right]} \quad (2)$$

TABLE I
THE INITIAL SET OF CRM ASPECTS AND CRITERIA

Aspects	Criteria
Effects	C1 Environmentally disruptive products
	C2 Becoming angry and frustrated about environmental destruction
	C3 Abusing the environment
	C4 Disrupting the balance of nature
	C5 Responsibility for environmental issues
Knowledge	C6 Ecological perspective
	C7 Atmosphere pollution factors
	C8 Primary cause of ocean creatures' disappearance
	C9 Safe time for returning to an irradiated area
Intention	C10 Soil pollution factors
	C11 Avoid purchasing potentially environmentally harmful products
	C12 Changing principal products to environmentally friendly versions
	C13 Choosing products that are less harmful to the environment
	C14 Making a special effort to purchase recycled paper and plastic products
Actual Purchase	C15 Making purchases without considering environmental issues
	C16 Feeling great when using green products
	C17 Feeling more comfortable when using green products instead of normal ones
	C18 No contribution to environment, despite experience of green products purchase.
	C19 Green product repurchase
CRM Technology	C20 Green product recommendation
	C21 Technical staff
	C22 Appropriate hardware
	C23 Appropriate software
	C24 Multi-functional information systems
	C25 Individualized information
	C26 Consolidated information
	C27 "Real time" customer-related information management
C28 Non-fulfillment of management needs	
Customer Orientation	C29 Increasing customer satisfaction
	C30 Understanding and serving customer needs
	C31 Increasing value for customers
	C32 Paying attention to after-sales service
	C33 Personalized products and services for key customers
Performance of CRM	C34 Attracting new customers
	C35 Retaining old customers
	C36 Increasing repeat purchases
	C37 Cross-selling to existing customers
	C38 Increasing customer loyalty
	C39 More efficient promotion
	C40 More efficient sales distribution
	C41 Low-cost customer services
C42 Higher share of profitable customers	
CRM Value Drivers	C43 Targeting profitable customers
	C44 Integrating offerings across channels
	C45 Improving sales force efficiency and effectiveness
	C46 Improving pricing
	C47 Customizing products and services
	C48 Improving customer service efficiency and effectiveness
Marketing Metrics	C49 Individualizing marketing messages
	C50 Direct acceptance
	C51 Selecting different lines
	C52 Improved relationship quality
	C53 Involvement in new product development
	C54 Communication frequency
	C55 Product/service improvement
C56 Increased order size	
C57 Higher-value order	

Sources: [73], [44], [74], [46], [75], [64], [76], [39], [25], [67], [72], [70]

TABLE II
 LINGUISTIC SCALES

Linguistic Terms (Performance/Importance)	Linguistic Values
Extreme	(0.75, 1.00, 1.00)
Demonstrated	(0.50, 0.75, 1.00)
Strong	(0.25, 0.50, 0.75)
Moderate	(0.00, 0.25, 0.50)
Equal	(0.00, 0.00, 0.25)

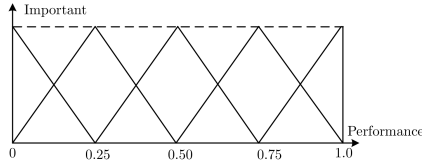
 Triangular fuzzy membership
 functions
 for Performance/Importance

The TFN is based on a three-value judgement: the minimum possible value a_1 , the mean possible value a_2 , and the maximum possible value a_3 . The criteria values depend on linguistic preferences.

Assuming the value of the significance of number j element given by number i experts is $\tilde{a} = (a_{ij}, b_{ij}, c_{ij})$, $i = 1, 2, 3, \dots, n$; $j = 1, 2, 3, \dots, m$. The weighting of \tilde{a}_j of no. j element is $\tilde{a}_j = (a_j, b_j, c_j)$, which $a_j = \min\{a_{ij}\}$, $b_j = \frac{1}{n} \sum_{i=1}^n b_{ij}$, and $c_j = \max\{c_{ij}\}$. Then, using the simple center of gravity method to Delphi the fuzzy weight \tilde{a}_j , the definite value of \tilde{R}_j is obtained. The proper criteria can be taken from numerous criteria by setting the threshold α . The α is calculated by the average of all criteria S ($S_j = \frac{1}{3}(a_j, b_j, c_j)$). The principle of showing is as follows:

if $\tilde{R}_j \geq \alpha$, the no. b criteria is accepted for evaluation

if $\tilde{R}_j \leq \alpha$, the no. b criteria is unaccepted

B. Fuzzy Set Theory

Let M_{ij} be the importance-weighted value of perspective i and criterion j . The membership function of TFN is $M_{ij} \in S$. Let P_{ij} be the performance value of perspective i and criterion j . The membership function of TFN is $P_{ij} \in T$. Table 2 displays the linguistic scales and TFNs for intangible linguistic scales in which the terms are defined [79].

 TABLE III
 EXPERT WEIGHTS (W_e)

Experts (n)	1	2	3	4	5	6	7
Weights	0.11	0.17	0.13	0.14	0.10	0.16	0.19

$$M_{ij}^n = (wl_{ij}^n, wm_{ij}^n, wu_{ij}^n), M_{ij} \in S \quad (3)$$

where $0 \leq wl_{ij} \leq wm_{ij} \leq wu_{ij} \leq 1$

$$P_{ij}^n = (pl_{ij}^n, pm_{ij}^n, pu_{ij}^n), M_{ij} \in T \quad (4)$$

where $0 \leq pl_{ij} \leq pm_{ij} \leq pu_{ij} \leq 1$

Table 2 presents the weights of each expert's multiplier. Equations (5) and (6) are used to aggregate the expert opinions on performance and importance values as

$$M_{ij}^n = M_{ij}^1 W_{e1} + M_{ij}^2 W_{e2} + M_{ij}^3 W_{e3} + \dots + M_{ij}^n W_{en} \quad (5)$$

$$P_{ij}^n = P_{ij}^1 W_{e1} + P_{ij}^2 W_{e2} + P_{ij}^3 W_{e3} + \dots + P_{ij}^n W_{en} \quad (6)$$

where M_{ij} and W_{en} are the value of respondents for perspective i and criterion j and the expert weights and number of experts in the evaluation, respectively. Because the output of the fuzzy system is a fuzzy set, the Delphi fuzzification procedure is used to convert the fuzzy results into crisp numbers. The center of area yields better results than the mean of maximum. The center of area is a simple and practical method for calculating non-fuzzy performance (BNP) values [80], [79]. Equations (7) and (8) determine the BNP values of the fuzzy weights.

$$\text{BNP}_i^w = \frac{1}{3} [(wu_{ij}^n - wl_{ij}^n) + (wm_{ij}^n + wl_{ij}^n)] + wl_{ij}^n, \forall i \quad (7)$$

$$\text{BNP}_i^p = \frac{1}{3} [(pu_{ij}^n - pl_{ij}^n) + (pm_{ij}^n + pl_{ij}^n)] + pl_{ij}^n, \forall i \quad (8)$$

C. Importance-performance Analysis

Martilla and James originally proposed the IPA to provide insights to identify a firm's strengths and weaknesses [60]. IPA is typically viewed as a type of marketing study technique that involves analyzing customer attitudes toward salient product or service attributes and helps practitioners prioritize the improvement opportunities of product or service attributes and direct quality-based marketing strategies [81].

Quadrant (I) represents major strengths and potential competitive advantages that should be maintained or exploited. It is assumed that scarce resources are effectively allocated where they are needed most and that current action strategies should be kept in place or enhanced (i.e., keep up the good work). Quadrant (II) captures attributes that are suggestive of over performance. Marginal resources are directed at attributes that represent minor strengths with minimum impact on the firm's or a destination's relative competitiveness (i.e., possible overkill).

In addition, Quadrant (III) is likely to be a low priority when decision makers ration scarce resources, and they are potential candidates for completely losing out on resources and effort. If no gains can be achieved from improved performance, extra effort in this area is unnecessary (i.e., it is a low priority). Quadrant (IV) is underperformance: these attributes require immediate attention and the highest prioritization in terms of resources and effort. The criteria identified in this quadrant represent major weaknesses and threats to competitiveness. Policy changes and strategies should focus on directing marginal resources and extra effort to these attributes (i.e., concentrate here) [60].

D. Proposed Approach

To achieve the objectives of this study, the CRM perspectives and green purchasing are measured in a four-step procedure:

- 1) Identifying the CRM model and green purchasing: this initial set of aspect and criteria is identified from the literature and expert perceptions.
- 2) Twenty industrial experts and academics that understand and are experienced in Taiwan's food industry responded to the study. This

study collects the experts' judgments and applies FDM to eliminate those aspects and criteria that are less important in three rounds of perception judgment. Finally, seven aspects and 27 criteria are taken for further analysis.

- 3) This study uses expert preferences for importance and performance levels. Thus, the fuzzy set theory is used to synthesize expert opinions on performance and the importance of crisp values.
- 4) Ultimately, IPA is utilized to analyze the aspects and criteria for evaluating the proposed CRM model. Thus, to determine the attributes, one might contribute to the industrial practitioners and examine the CRM model.

IV. RESULTS

This section discusses the industrial background of Taiwan's food industry and presents the analytical results of the CRM model.

A. Industrial Background

In recent years, Taiwan's food industry has experienced a strong increase thanks to relevant improvement and investment. The green food market has been mentioned as one of the most rapidly growing sectors primarily because customers purchase and consume green foods for their perceived health benefits, food safety, quality, and taste. However, PI of customer toward green purchasing in general and green food in particular is not very high. Although the benefits that green products bring to consumers is very important when they are using the products, the lack of access to knowledge results in the customer's PI towards these products failing to improve. Therefore, the firm must implement CRM and creates knowledge for customers so that those customers can recognize the essential role of green products.

Through CRM, it is necessary for organizations to understand customer requirements. In the field of green foods, customer demand is especially diverse because tastes change continuously. Therefore, understanding and anticipating customer needs are priority tasks for a firm to be able to carry out CRM correctly. Taking this approach, the firm can enhance attention and IP from its customers. In this study, the important evaluation of aspects and

criteria is conducted by the experts. The potential advantages for firm competitiveness are analyzed to provide recommendations and solutions for the firm to improve its performance. The results of this study are shown in Section 4.2 (Results).

The FDM is used to eliminate part of the criteria based on expert opinions. The FDM judgment is presented in Table 4 for the initial 57 criteria. The threshold value (0.2476) is computed. Finally, the 27 criteria (NC1-NC27) are presented with expert validity.

Table 5 presents the importance and the performance applying equations (7)-(8) to compute the BNP_i^p performance and BNP_i^w importance weighting scores.

The result of the IPA model shows that there are 10 criteria in the “Keep up the good work” quadrant. This quadrant illustrates the major strengths and potential competitive advantages for the firm to run its business. At present, protecting the environment is considered a special concern for many countries; thus, customers pay an increasing amount of attention to green products. Customers present their feelings when using products that disrupt the environment (NC1): they become angry and frustrated about how humans are destroying the environment (NC2). With this mindset, customers have realized the important role of green products that can protect their health. Therefore, avoiding the purchase of products that are potentially harmful to the environment (NC7) and making a special effort to purchase paper and plastic products made from recycled materials (NC9) are essential customer intentions to reduce environmental issues. Moreover, the modification of customer behavior by changing from the original products to ecological versions with the same utility (NC10) is appreciated as a positive alteration that the firm should develop to obtain maximum value. In the CRM technology aspect, using the appropriate software (NC17) and consolidating customer information (NC20) are crucial elements that help the firm build CRM successfully. Therefore, these criteria create a variety of opportunities to improve customer relationships based on understanding customer needs and intentions. Overall, criteria that belong to this quadrant should be maintained and exploited to “keep up the good work.”

Meanwhile, the “Potential overkill” quadrant

presents a clear vision about over-performance capabilities based on the research results. There are five criteria in this quadrant. In the CRM technology aspect, technology staff performance (NC16) is very high but importance is low. The reason is that by using the right software and right hardware, the firm can build a multi-functional information system that collects and consolidates customer information. This information is necessary for a firm to approach and contact their customers to maintain long-term relationships. Therefore, the firm’s staff may not be very important due to technology development. Additionally, more-efficient sales distribution (NC26) and low-cost customer services (NC27) are two criteria that result in high performance for the firm. However, the result shows that these criteria seem not to affect customer purchasing very much, although the firm effectively carries them out. Therefore, with the criteria that bring high performance but do not have much importance for firm development, the firm should implement cost-cutting strategies and invest in important and necessary policies.

Four criteria fall into the “Low priority” quadrant. These criteria are not very important and pose no threat to firms; their resources are relatively unnoticed and should remain unaffected. The actual purchase aspect shows that customers cannot do very much about the environment and that their experience of green products does not change that belief (NC12). Moreover, the real time that relates to customer information management (NC21) is also mentioned in this quadrant. This study’s results show that these criteria do little to affect either the firm’s performance or its importance. The reason is that with the development of CRM technology, the firm also has an information system to manage customer information effectively; therefore, the firm can save its time and invest in higher-priority missions. Overall, most of the criteria in the third quadrant do not affect the firm’s CRM perspectives. These criteria are resources that the firms do not implement well; thus, they do not focus very much on criteria with low importance and instead should concentrate on highly important resources.

There are eight criteria belonging to the “Concentrate here” quadrant, which can imply that the firm should concentrate more on making firm performance effective. Criteria that fall into this quadrant

TABLE IV
THE RESULTS OF FUZZY DELPHI METHOD

AS	C	NC	l	m	u	l	u	R_j	Judgment
Person's Effects	C1	NC1	0.5	0.9605	1	0.2697	0.9803	0.2956	Acceptable
	C2	NC2	0.5	0.9605	1	0.2697	0.9803	0.2956	Acceptable
	C3	NC3	0.5	0.8862	1	0.3069	0.9431	0.2933	Acceptable
	C4		0.25	0.8042	1	-0.0271	0.9021	0.2204	Unacceptable
	C5		0.25	0.8042	1	-0.0271	0.9021	0.2204	Unacceptable
Knowledge	C6		0.25	0.8717	1	-0.0608	0.9358	0.2226	Unacceptable
	C7	NC4	0.5	0.8512	1	0.3244	0.9256	0.2922	Acceptable
	C8		0	0.7179	1	-0.359	0.859	0.1474	Unacceptable
	C9	NC5	0.5	0.8176	1	0.3412	0.9088	0.2912	Acceptable
	C10	NC6	0.75	1	1	0.625	1	0.3672	Acceptable
Intention	C11	NC7	0.5	0.9605	1	0.2697	0.9803	0.2956	Acceptable
	C12		0	0.6258	1	-0.3129	0.8129	0.1446	Unacceptable
	C13	NC8	0.5	0.8512	1	0.3244	0.9256	0.2922	Acceptable
	C14	NC9	0.5	0.9605	1	0.2697	0.9803	0.2956	Acceptable
	C15	NC10	0.5	0.9605	1	0.2697	0.9803	0.2956	Acceptable
Actual Purchase	C16	NC11	0.5	0.8512	1	0.3244	0.9256	0.2922	Acceptable
	C17	NC12	0.5	0.8176	1	0.3412	0.9088	0.2912	Acceptable
	C18	NC13	0.5	0.9605	1	0.2697	0.9803	0.2956	Acceptable
	C19	NC14	0.75	1	1	0.625	1	0.3672	Acceptable
	C20	NC15	0.5	0.8176	1	0.3412	0.9088	0.2912	Acceptable
Technology	C21	NC16	0.5	0.9226	1	0.2887	0.9613	0.2945	Acceptable
	C22		0.25	0.7725	1	-0.0112	0.8862	0.2195	Unacceptable
	C23	NC17	0.75	1	1	0.625	1	0.3672	Acceptable
	C24	NC18	0.5	0.9226	1	0.2887	0.9613	0.2945	Acceptable
	C25	NC19	0.5	0.9605	1	0.2697	0.9803	0.2956	Acceptable
	C26	NC20	0.5	0.9605	1	0.2697	0.9803	0.2956	Acceptable
	C27	NC21	0.5	0.8862	1	0.3069	0.9431	0.2933	Acceptable
	C28		0.25	0.8236	1	-0.0368	0.9118	0.221	Unacceptable
Customer Orientation	C29	NC22	0.5	0.8176	1	0.3412	0.9088	0.2912	Acceptable
	C30	NC23	0.5	0.9226	1	0.2887	0.9613	0.2945	Acceptable
	C31		0.25	0.8373	1	-0.0436	0.9186	0.2215	Unacceptable
	C32		0.25	0.9075	1	-0.0788	0.9538	0.2237	Unacceptable
	C33	NC24	0.5	0.8176	1	0.3412	0.9088	0.2912	Acceptable
Performance	C34		0.25	0.8717	1	-0.0608	0.9358	0.2226	Unacceptable
	C35		0.25	0.7725	1	-0.0112	0.8862	0.2195	Unacceptable
	C36		0.25	0.7911	1	-0.0205	0.8955	0.22	Unacceptable
	C37	NC25	0.5	0.8862	1	0.3069	0.9431	0.2933	Acceptable
	C38		0.25	0.7179	1	0.016	0.859	0.2177	Unacceptable
	C39		0	0.6896	1	-0.3448	0.8448	0.1465	Unacceptable
	C40	NC26	0.5	0.9605	1	0.2697	0.9803	0.2956	Acceptable
	C41	NC27	0.5	0.9605	1	0.2697	0.9803	0.2956	Acceptable
	C42		0.25	0.7725	1	-0.0112	0.8862	0.2195	Unacceptable
Value Drivers	C43		0.25	0.6896	1	0.0302	0.8448	0.2169	Unacceptable
	C44		0	0.7911	1	-0.3955	0.8955	0.1497	Unacceptable
	C45		0	0.7911	1	-0.3955	0.8955	0.1497	Unacceptable
	C46		0.25	0.8717	1	-0.0608	0.9358	0.2226	Unacceptable
	C47		0.25	0.6896	1	0.0302	0.8448	0.2169	Unacceptable
	C48		0.25	0.8717	1	-0.0608	0.9358	0.2226	Unacceptable
	C49		0.25	0.6896	1	0.0302	0.8448	0.2169	Unacceptable
Marketing Metrics	C50		0.25	0.8717	1	-0.0608	0.9358	0.2226	Unacceptable
	C51		0	0.7911	1	-0.3955	0.8955	0.1497	Unacceptable
	C52		0.25	0.8717	1	-0.0608	0.9358	0.2226	Unacceptable
	C53		0.25	0.6896	1	0.0302	0.8448	0.2169	Unacceptable
	C54		0	0.7911	1	-0.3955	0.8955	0.1497	Unacceptable
	C55		0	0.701	1	-0.3505	0.8505	0.1469	Unacceptable
	C56		0.25	0.6896	1	0.0302	0.8448	0.2169	Unacceptable
	C57		0	0.7911	1	-0.3955	0.8955	0.1497	Unacceptable

TABLE V
IMPORTANCE (BNP_i^w), PERFORMANCE (BNP_i^p)

Aspects	Importance			Performance			BNP_i^w	BNP_i^p
	<i>l</i>	<i>m</i>	<i>u</i>	<i>l</i>	<i>m</i>	<i>u</i>		
As1	0.673	0.923	0.975	0.668	0.918	0.975	0.857	0.853
As2	0.64	0.89	1	0.535	0.785	1	0.843	0.773
As3	0.655	0.905	0.965	0.58	0.83	1	0.842	0.803
As4	0.535	0.785	0.948	0.548	0.798	0.753	0.756	0.699
As6	0.623	0.873	0.96	0.643	0.893	1	0.818	0.845
As6	0.62	0.87	0.973	0.51	0.76	0.923	0.821	0.731
As7	0.488	0.738	0.953	0.698	0.948	1	0.726	0.882

represent key areas, the improvement of which is a top priority. Because green purchasing is a new concept in the customer's mind, creating customer knowledge about green products is a very important firm mission. The customer must know about the ecological perspective (NC5) and the factors that cause atmospheric pollution (NC4) to understand the role of using green products, which can protect their health. Thus, the firm must focus on providing the customer with environmental knowledge that can enhance their intentions to purchase green products. In addition, key customers are regarded as a competitive advantage for any firm and thus, it very essential to make personalized products and services for them (NC24). In addition, maintaining the relationship between the firm and its customers through promotion policies and service quality that increase customer satisfaction (NC22) is the best way to retain a firm's customers. With respect to the actual purchase aspect, green product recommendation (NC15) is the criterion that needs more attention from the firm because when a customer recommends green products to friends and family, those products receive increased attention. In this fashion, the firm can obtain a great deal of PI, along with increased profits. In summary, the factors defined in this quadrant represent the major weaknesses and threats to competitiveness. Thus, those issues must focus on immediate solutions to ameliorate firm performance.

The aspects result presents three aspects belong to Quadrant (I) with person's effect (AS1), intention (AS3), and technology (AS5). These aspects are regarded as a firm's competitive advantages because they play the key role in customer purchases. Meanwhile, Quadrant (II) mentions that performance of CRM (AS7) results in a high level of performance

but is not very important for firm development, which requires the firm to implement cost-cutting strategies and to invest in important and necessary policies. In Quadrant (III), the result shows that actual purchases (AS4) is identified as low priority because they are not very important and pose no threat. Knowledge (AS2) and customer orientation (AS6) are aspects shown in Quadrant (IV). Two aspects are mentioned as priority areas for improvement. The reason is that in the customer's mind, green purchasing is a new concept; therefore, orienting customers and creating customer knowledge about green products are very important tasks.

V. IMPLICATIONS

This section discusses the implications not only for theory but also for management. First, this study expands the existing competitive advantages research on the CRM model and PI towards green products. In addition, customer awareness about environmental issues has been updated recently. The more concerned customers are about the environment, the more intention they have towards green products. The implications are discussed.

A person's effect automatically integrates the TPB through customer attitudes. Specifically, an underground collaboration among customers has an impact on their behavior. CRM for the food industry is an important tool to create strong relationships with customers. The most effective path to success is to improve knowledge and person's effects related to environmental issues [46]. With more knowledge, consumers can understand what is happening to the environment in the area of industrialization, and they can have a positive impact in protecting the environment.

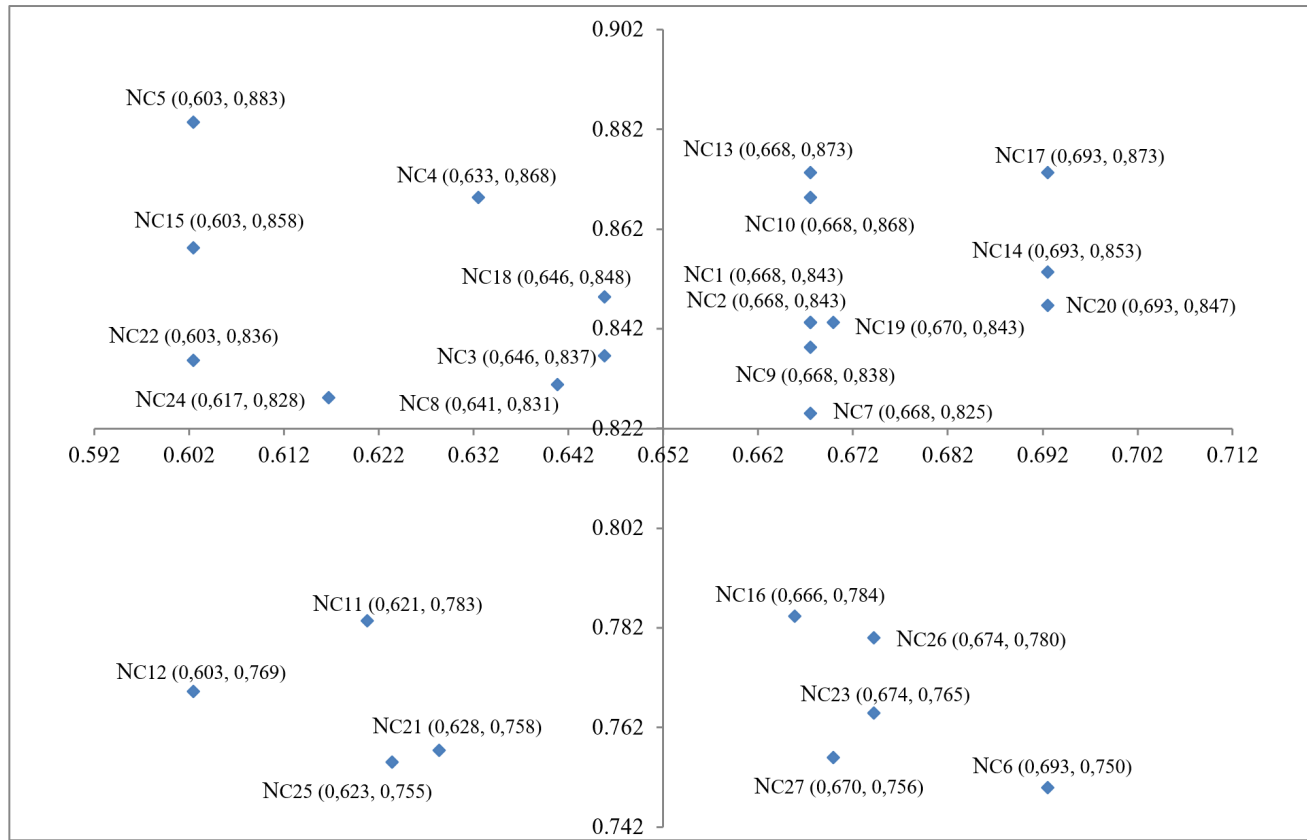

Fig. 1. The result of criteria.

The technology considered is a critical aspect that allows collection and analysis of customer information to foster closer relationships with customers. It provides numerous benefits that enable firms to improve the effectiveness of the processes involved in customer relationships and to respond quickly to changes in the environment and customer needs. Therefore, it is essential for firms to require an integrated information system that provides accurate, real-time, and relevant customer information to all employees. Moreover, the firm must apply the proper technology to optimize the business processes involved in customer relationships.

Customer intention is an important aspect. Customer purchasing power increases when customer intention is high. TPB states that PI determines a customer’s actual buying behavior. The results provided strong support for integrating the CRM model and PI arguments. This might link consumers’ PIs and the criteria involved in determining how to construct

the CRM model. In addition, this analysis noted that the analysis establishes traditional CRM differences between actual purchasing, which depends on their personal effects related to the TPB model. Therefore, the firm enhances customer strategies through the proposed CRM model. Thus, green purchasing contributes to influence customer intentions.

The results of this study in the “keep up the good work” quadrant showed that the three aspects of person effect, intention, and CRM technology should be maintained and improved regularly because the person effect has the greatest impact on the process. More specifically, person effect stimulates customer intention, which combines PI with the customer intention collected by CRM technology. CRM technology increases customer information to help the firm connect to its targets. On the other hand, the “low priority” quadrant, which is opposite the “keep up the good work” quadrant, revealed the low priority of the actual purchase because the three

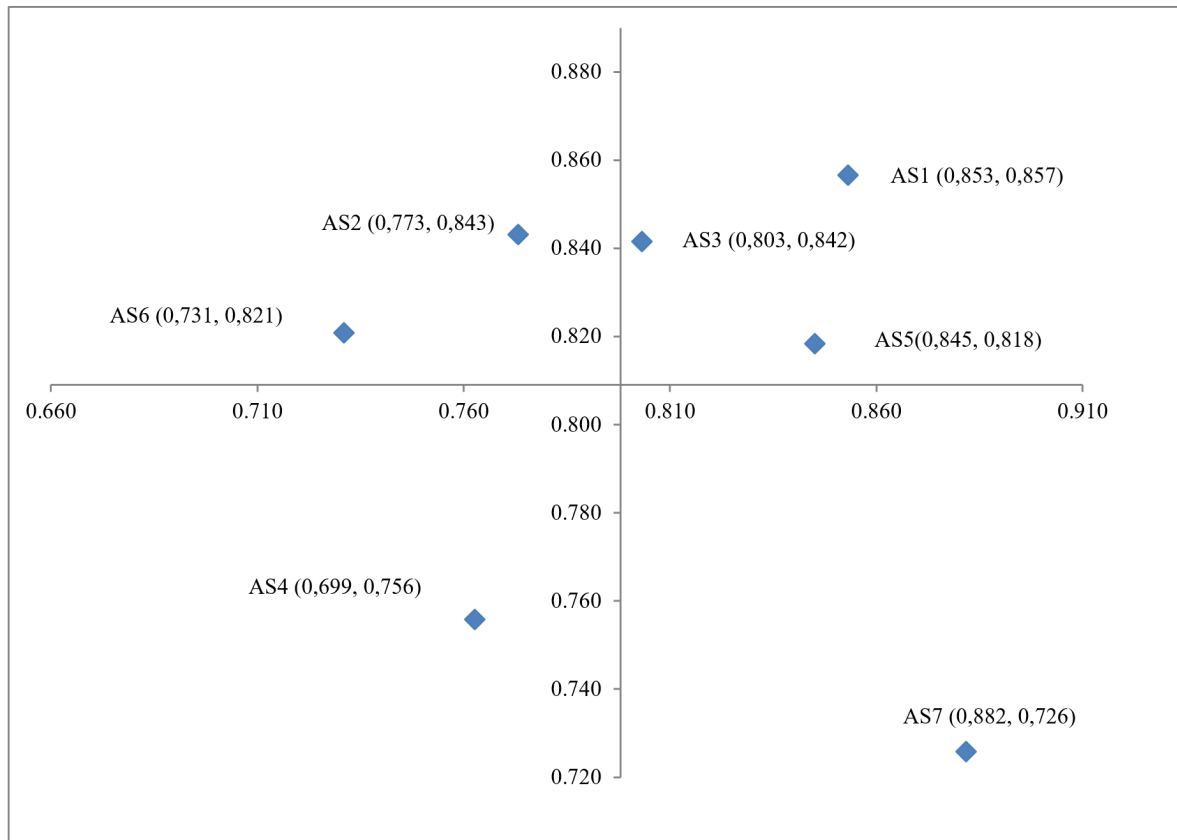

Fig. 2. IPA result of Aspect.

first aspects have been achieved.

The theoretical implication of these results is that CRM is the missing puzzle to connect the TPB with green purchasing and intentions. Through the information provided by CRM, firms can collect data and analysis to increase customer GP and PI. This study identifies CRM as a key factor that directly influences green purchasing activities and the firm's understanding of customer behaviors. Furthermore, PI is a crucial element that can determine customers' green buying behavior because customer behavior in TPB depends on determining actual behaviors and green purchasing actions. This means that PI is created by the CRM through the process of a customer's decision-making.

The study provides some insight for managers in the food industry. Like previous research, this study underlines the importance of management support for quality to proving quality practices. With respect to CRM, it would be beneficial to managers in food

firms to engage in practices—such as the reduction of soil pollution, materials, and staff—that could have a direct impact on their external and internal quality practices. Moreover, managers should take positive action to improve the environment and to upgrade customer information and facilities. Firms are interested in improving the image of their products by enhancing quality with reasonable prices and environmental friendliness. In the future, businesses should improve packaging for easy waste recycling.

In addition to focusing on green products, managers must constantly train company staff. Employees are the face of a business. Employees must be cheerful and polite to customers to obtain their trust. Moreover, employees should purchase environmentally friendly products and encourage people to avoid buying products that are potentially harmful to the environment. In particular, staff that work with clients should always respect the confidentiality of customers' individualized information. This is a way

to help businesses to have good relationships with their customers.

The result provides a new horizon for the green food industry to continue innovating for its customers—growing, learning, and identifying areas for improvement in specific aspects of CRM. The key role of PI in CRM has increased dramatically, leveraged by green effectiveness and its relationship to the green food industry. Consequently, this study has led to tremendously increased awareness of the industry's sustainable business process.

VI. CONCLUSION

Firms intent on increasing profits must focus on how much customers care about them. Thus, managing a set of objective performance criteria and understanding the focus of customer attention are priority tasks. There has been a significant increase in customer awareness about environmental issues in the competitive market, and many studies have discovered customer willingness to pay more for environmentally friendly products [82], [83], [84]. Moreover, CRM is a key factor that directly influences green purchasing activities and the understanding of customers' PI towards the firm [15]. However, little research has investigated CRM impact on green purchasing, particularly that associated with green food choice. Therefore, this study applied FDM to construct performance aspects and criteria for the food industry to understand how these aspects and criteria could be effective in affecting consumers and PI about green products regarding green food. The results show findings that predict Taiwanese customers' intentions to purchase green food.

The finding shows customers' green purchasing and PI towards impacts that harm the environment are potential competitive advantages. The change from original products to recycled and ecological products have received considerable customer acceptance, thanks to their ability to comprehend environmental issues. Within the study, both the importance and performance scores for criteria about customers' actual purchases of green products are high, which may relate to the fact that customers pay a great deal of attention to green products that can protect their health and their surroundings. Firms should maintain the current situation, to earn more customer

reliability. In addition, the customers should be provided with more information about the ecological perspective and about the causes of environmental pollution. The existing intentions and consumer knowledge play important roles in influencing PI.

This study also has some limitations. First, even though the study examines the PI of customers towards green products, it has not focused on occasional and regular consumers of green food. Further research, therefore, might put more effort in distinguishing the differences between them because regular consumers are generally assumed to pay more attention to green food than do occasional consumers [85]. Second, this study's findings are applicable only to Taiwan's food industry and may not fit other countries. In addition, because this study suffers from a relatively small sample size and depends on the opinions of a group of experts, which limits the findings from deeper and wider results, it is hoped that further studies can advance CRM and green purchasing issues for other industries. This creates opportunity for further, more comprehensive research on green purchasing and CRM.

REFERENCES

- [1] J. G. Van der Vorst and A. J. Beulens, "Identifying sources of uncertainty to generate supply chain redesign strategies," *International Journal of Physical Distribution & Logistics Management*, vol. 32, no. 6, pp. 409–430, 2002.
- [2] F. Wiengarten, M. Pagell, and B. Fynes, "Supply chain environmental investments in dynamic industries: Comparing investment and performance differences with static industries," *International Journal of Production Economics*, vol. 135, no. 2, pp. 541–551, 2012.
- [3] J. Trienekens, P. Wognum, A. J. Beulens, and J. G. van der Vorst, "Transparency in complex dynamic food supply chains," *Advanced Engineering Informatics*, vol. 26, no. 1, pp. 55–65, 2012.
- [4] A. D. d. C. Lemos and A. Giacomucci, "Green procurement activities: Some environmental indicators and practical actions taken by industry and tourism," *International Journal of Environment and Sustainable Development*, vol. 1, no. 1, pp. 59–72, 2002.
- [5] N. Kalogeras, S. Valchovska, G. Baourakis, and P. Kalaitzis, "Dutch consumers' willingness to pay for organic olive oil," *Journal of International Food & Agribusiness Marketing*, vol. 21, no. 4, pp. 286–311, 2009.
- [6] S. Hallstedt, H. Ny, K.-H. Robèrt, and G. Broman, "An approach to assessing sustainability integration in strategic decision systems for product development," *Journal of Cleaner Production*, vol. 18, no. 8, pp. 703–712, 2010.

- [7] T. S. Teo, P. Devadoss, and S. L. Pan, "Towards a holistic perspective of customer relationship management (CRM) implementation: A case study of the housing and development board, Singapore," *Decision Support Systems*, vol. 42, no. 3, pp. 1613–1627, 2006.
- [8] E. W. Ngai, "Customer relationship management research (1992–2002) an academic literature review and classification," *Marketing Intelligence & Planning*, vol. 23, no. 6, pp. 582–605, 2005.
- [9] J. Davies, G. R. Foxall, and J. Pallister, "Beyond the intention–behaviour mythology an integrated model of recycling," *Marketing Theory*, vol. 2, no. 1, pp. 29–113, 2002.
- [10] I. Fecikova, "An index method for measurement of customer satisfaction," *The TQM Magazine*, vol. 16, no. 1, pp. 57–66, 2004.
- [11] Ş. Özgener and R. İraz, "Customer relationship management in small–medium enterprises: The case of Turkish tourism industry," *Tourism Management*, vol. 27, no. 6, pp. 1356–1363, 2006.
- [12] J. Peppard, "Customer relationship management (CRM) in financial services," *European Management Journal*, vol. 18, no. 3, pp. 312–327, 2000.
- [13] P. Sivaraks, D. Krairit, and J. C. Tang, "Effects of e-CRM on customer–bank relationship quality and outcomes: The case of Thailand," *The Journal of High Technology Management Research*, vol. 22, no. 2, pp. 141–157, 2011.
- [14] S.-I. Wu and C.-L. Lu, "The relationship between CRM, RM, and business performance: A study of the hotel industry in Taiwan," *International Journal of Hospitality Management*, vol. 31, no. 1, pp. 276–285, 2012.
- [15] C. R. Carter and L. M. Ellram, "Reverse logistics: A review of the literature and framework for future investigation," *Journal of Business Logistics*, vol. 19, no. 1, p. 85, 1998.
- [16] E. E. Karsak, "Fuzzy multiple objective decision making approach to prioritize design requirements in quality function deployment," *International Journal of Production Research*, vol. 42, no. 18, pp. 3957–3974, 2004.
- [17] S. R. Nasserzadeh, M. H. Jafarzadeh, T. Mansouri, and B. Sohrabi, "Customer satisfaction fuzzy cognitive map in banking industry," *Communications of the IBIMA*, vol. 2, no. 21, pp. 151–162, 2008.
- [18] C. Rygielski, J.-C. Wang, and D. C. Yen, "Data mining techniques for customer relationship management," *Technology in Society*, vol. 24, no. 4, pp. 483–502, 2002.
- [19] Z. Ma, C. Shao, S. Ma, and Z. Ye, "Constructing road safety performance indicators using fuzzy delphi method and grey delphi method," *Expert Systems with Applications*, vol. 38, no. 3, pp. 1509–1514, 2011.
- [20] S. Mi Dahlggaard-Park, V. Pezeshki, A. Mousavi, and S. Grant, "Importance-performance analysis of service attributes and its impact on decision making in the mobile telecommunication industry," *Measuring Business Excellence*, vol. 13, no. 1, pp. 82–92, 2009.
- [21] A. Garrido-Moreno and A. Padilla-Meléndez, "Analyzing the impact of knowledge management on CRM success: The mediating effects of organizational factors," *International Journal of Information Management*, vol. 31, no. 5, pp. 437–444, 2011.
- [22] P. Kothandaraman and D. T. Wilson, "Implementing relationship strategy," *Industrial Marketing Management*, vol. 29, no. 4, pp. 339–349, 2000.
- [23] A. Cöner and M. Güngör, "Factors affecting customer loyalty in the competitive turkish metropolitan retail markets," *Journal of American Academy of Business*, vol. 2, no. 1, pp. 189–195, 2002.
- [24] J. U. Becker, G. Greve, and S. Albers, "The impact of technological and organizational implementation of CRM on customer acquisition, maintenance, and retention," *International Journal of Research in Marketing*, vol. 26, no. 3, pp. 207–215, 2009.
- [25] L. Y. Sin, A. C. Tse, and F. H. Yim, "CRM: Conceptualization and scale development," *European Journal of Marketing*, vol. 39, no. 11/12, pp. 1264–1290, 2005.
- [26] R. Chalmeta, "Methodology for customer relationship management," *Journal of Systems and Software*, vol. 79, no. 7, pp. 1015–1024, 2006.
- [27] D. Peppers and M. Rogers, *Managing Customer Relationships: A Strategic Framework*. John Wiley & Sons, 2004.
- [28] T. Puschmann and R. Alt, "Customer relationship management in the pharmaceutical industry," in *System Sciences, 2001. Proceedings of the 34th Annual Hawaii International Conference On*. IEEE, 2001, pp. 9–pp.
- [29] M. Nykamp, *The Customer Differential: The Complete Guide to Implementing Customer Relationship Management*. Amacom, 2001.
- [30] M. Hayes and J. Freeland, "Partner relationship management: The next generation of the extended enterprise," *The Ultimate CRM Handbook*, McGraw-Hill, New York, pp. 153–164, 2003.
- [31] R. P. Kotorov, "Ubiquitous organization: Organizational design for e-CRM," *Business Process Management Journal*, vol. 8, no. 3, pp. 218–232, 2002.
- [32] W. Reinartz, M. Krafft, and W. D. Hoyer, "The customer relationship management process: Its measurement and impact on performance," *Journal of Marketing Research*, vol. 41, no. 3, pp. 293–305, 2004.
- [33] D. L. Goodhue, B. H. Wixom, and H. J. Watson, "Realizing business benefits through CRM: Hitting the right target in the right way," *MIS Quarterly Executive*, vol. 1, no. 2, pp. 79–94, 2002.
- [34] K. Anderson and C. Kerr, *Customer Relationship Management*, ser. Briefcase Books Series. New York, NY, USA: McGraw-Hill Education, 2001. [Online]. Available: https://books.google.com.ph/books?id=DE2Pbd_qmgkC
- [35] S. L. Pan and J.-N. Lee, "Using e-CRM for a unified view of the customer," *Communications of the ACM*, vol. 46, no. 4, pp. 95–99, 2003.
- [36] B. Johnson and P. Nunes, "Let's talk: Applying the art of conversation to customer contact," *The Ultimate CRM Handbook*, McGraw-Hill, New York, pp. 118–125, 2003.
- [37] A. P. Massey, M. M. Montoya-Weiss, and K. Holcom, "Re-engineering the customer relationship: Leveraging knowledge assets at IBM," *Decision Support Systems*, vol. 32, no. 2, pp. 155–170, 2001.
- [38] K.-H. Chang and C.-H. Cheng, "Evaluating the risk of failure using the fuzzy owa and DEMATEI method," *Journal of Intelligent Manufacturing*, vol. 22, no. 2, pp. 113–129, 2011.
- [39] Y. Kim and S. M. Choi, "Antecedents of green purchase

- behavior: An examination of collectivism, environmental concern, and PCe,” *Advances in Consumer Research*, vol. 32, p. 592, 2005.
- [40] H. Min and W. P. Galle, “Green purchasing practices of us firms,” *International Journal of Operations & Production Management*, vol. 21, no. 9, pp. 1222–1238, 2001.
- [41] K. Lee, “Gender differences in hong kong adolescent consumers’ green purchasing behavior,” *Journal of Consumer Marketing*, vol. 26, no. 2, pp. 87–96, 2009.
- [42] L. Preuss, “In dirty chains? purchasing and greener manufacturing,” *Journal of Business Ethics*, vol. 34, no. 3–4, pp. 345–359, 2001.
- [43] K. D. Van Liere and R. E. Dunlap, “The social bases of environmental concern: A review of hypotheses, explanations and empirical evidence,” *Public Opinion Quarterly*, vol. 44, no. 2, pp. 181–197, 1980.
- [44] K. Lee, “Opportunities for green marketing: Young consumers,” *Marketing Intelligence & Planning*, vol. 26, no. 6, pp. 573–586, 2008.
- [45] R. D. Straughan and J. A. Roberts, “Environmental segmentation alternatives: A look at green consumer behavior in the new millennium,” *Journal of Consumer Marketing*, vol. 16, no. 6, pp. 558–575, 1999.
- [46] S. Bonini and J. Oppenheim, “Cultivating the green consumer,” *Stanford Social Information Review*, vol. 6, no. 4, pp. 56–62, 2008.
- [47] R. Y. Chan and L. B. Lau, “Antecedents of green purchases: A survey in China,” *Journal of Consumer Marketing*, vol. 17, no. 4, pp. 338–357, 2000.
- [48] S. P. Kalafatis, M. Pollard, R. East, and M. H. Tsogas, “Green marketing and ajzen’s theory of planned behaviour: A cross-market examination,” *Journal of Consumer Marketing*, vol. 16, no. 5, pp. 441–460, 1999.
- [49] I. Ajzen, “Theories of cognitive self-regulation the theory of planned behavior,” *Organizational Behavior and Human Decision Processes*, vol. 50, no. 2, pp. 179–211, 1991. [Online]. Available: <http://www.sciencedirect.com/science/article/pii/074959789190020T>
- [50] C. L. Beckford, C. Jacobs, N. Williams, and R. Nahdee, “Aboriginal environmental wisdom, stewardship, and sustainability: Lessons from the walpole island first nations, Ontario, Canada,” *The Journal of Environmental Education*, vol. 41, no. 4, pp. 239–248, 2010.
- [51] M. Fishbein, *Belief, Attitude, Intention, and Behaviour: An Introduction to Theory and Research*. Addison-Wesley, 1975.
- [52] I. Phau and M. Teah, “Devil wears (counterfeit) Prada: A study of antecedents and outcomes of attitudes towards counterfeits of luxury brands,” *Journal of Consumer Marketing*, vol. 26, no. 1, pp. 15–27, 2009.
- [53] Y.-L. Hsu, C.-H. Lee, and V. B. Kreng, “The application of fuzzy delphi method and fuzzy ahp in lubricant regenerative technology selection,” *Expert Systems with Applications*, vol. 37, no. 1, pp. 419–425, 2010.
- [54] Y.-F. Kuo and P.-C. Chen, “Constructing performance appraisal indicators for mobility of the service industries using fuzzy delphi method,” *Expert Systems with Applications*, vol. 35, no. 4, pp. 1930–1939, 2008.
- [55] H.-T. Liu and W.-K. Wang, “An integrated fuzzy approach for provider evaluation and selection in third-party logistics,” *Expert Systems with Applications*, vol. 36, no. 3, pp. 4387–4398, 2009.
- [56] N. Dalkey and O. Helmer, “An experimental application of the delphi method to the use of experts,” *Management Science*, vol. 9, no. 3, pp. 458–467, 1963.
- [57] J. R. Meredith, A. Raturi, K. Amoako-Gyampah, and B. Kaplan, “Alternative research paradigms in operations,” *Journal of Operations Management*, vol. 8, no. 4, pp. 297–326, 1989.
- [58] C. Okoli and S. D. Pawlowski, “The delphi method as a research tool: An example, design considerations and applications,” *Information & Management*, vol. 42, no. 1, pp. 15–29, 2004.
- [59] A. Kaufmann and M. M. Gupta, *Fuzzy Mathematical Models in Engineering and Management Science*. Elsevier Science Inc., 1988.
- [60] J. A. Martilla and J. C. James, “Importance-performance analysis,” *The Journal of Marketing*, pp. 77–79, 1977.
- [61] K. Matzler, F. Bailom, H. H. Hinterhuber, B. Renzl, and J. Pichler, “The asymmetric relationship between attribute-level performance and overall customer satisfaction: A reconsideration of the importance–performance analysis,” *Industrial Marketing Management*, vol. 33, no. 4, pp. 271–277, 2004.
- [62] C.-H. Tsen, G. Phang, H. Hasan, and M. R. Buncha, “Going green: A study of consumers’ willingness to pay for green products in kota kinabalu,” *International Journal of Business and Society*, vol. 7, no. 2, p. 40, 2006.
- [63] S. M. Bonini and J. M. Oppenheim, “Helping ‘green’ products grow,” *The McKinsey Quarterly*, vol. 3, no. 2, pp. 1–8, 2008.
- [64] Y. J. Jang, W. G. Kim, and M. A. Bonn, “Generation y consumers’ selection attributes and behavioral intentions concerning green restaurants,” *International Journal of Hospitality Management*, vol. 30, no. 4, pp. 803–811, 2011.
- [65] J. C. Narver and S. F. Slater, “The effect of a market orientation on business profitability,” *The Journal of Marketing*, pp. 20–35, 1990.
- [66] R. van Bentum and M. Stone, “Customer relationship management and the impact of corporate culture — a European study,” *Journal of Database Marketing & Customer Strategy Management*, vol. 13, pp. 28–54, 2005.
- [67] R. K. Srivastava, T. A. Shervani, and L. Fahey, “Marketing, business processes, and shareholder value: An organizationally embedded view of marketing activities and the discipline of marketing,” *The Journal of Marketing*, pp. 168–179, 1999.
- [68] Y. Wang, H. Po Lo, R. Chi, and Y. Yang, “An integrated framework for customer value and customer-relationship-management performance: A customer-based perspective from China,” *Managing Service Quality: An International Journal*, vol. 14, no. 2/3, pp. 169–182, 2004.
- [69] F. Hong-kit Yim, R. E. Anderson, and S. Swaminathan, “Customer relationship management: Its dimensions and effect on customer outcomes,” *Journal of Personal Selling & Sales Management*, vol. 24, no. 4, pp. 263–278, 2004.
- [70] A. Hirschowitz, “Closing the CRM loop: The 21st century marketer’s challenge: Transforming customer insight into customer value,” *Journal of Targeting, Measurement and Analysis for Marketing*, vol. 10, no. 2, pp. 168–178, 2001.

- [71] E. Jones, C. Stevens, and L. Chonko, "Selling ASAP: Art, Science, Agility, Performance," *Thompson/Southwestern*, 2005.
- [72] I. J. Chen and K. Popovich, "Understanding customer relationship management (CRM) people, process and technology," *Business Process Management Journal*, vol. 9, no. 5, pp. 672–688, 2003.
- [73] A. Sih, A. Bell, and J. C. Johnson, "Behavioral syndromes: An ecological and evolutionary overview," *Trends in Ecology & Evolution*, vol. 19, no. 7, pp. 372–378, 2004.
- [74] M. Austin, "Species distribution models and ecological theory: A critical assessment and some possible new approaches," *Ecological Modelling*, vol. 200, no. 12, pp. 1–19, 2007. [Online]. Available: <http://www.sciencedirect.com/science/article/pii/S0304380006003140>
- [75] G. Carrus, P. Passafaro, and M. Bonnes, "Emotions, habits and rational choices in ecological behaviours: The case of recycling and use of public transportation," *Journal of Environmental Psychology*, vol. 28, no. 1, pp. 51–62, 2008.
- [76] N. Mazar and C.-B. Zhong, "Do green products make us better people?" *Psychological Science*, 2010.
- [77] N. G. Noorderhaven, *Strategic Decision Making*. Addison-Wesley Reading, 1995.
- [78] E. Triantaphyllou and B. Shu, "On the maximum number of feasible ranking sequences in multi-criteria decision making problems," *European Journal of Operational Research*, vol. 130, no. 3, pp. 665–678, 2001.
- [79] H.-H. Wu, H.-K. Chen, and J.-I. Shieh, "Evaluating performance criteria of employment service outreach program personnel by DEMATEL method," *Expert Systems with Applications*, vol. 37, no. 7, pp. 5219–5223, 2010.
- [80] T. Runkler and M. Glesner, "A set of axioms for defuzzification strategies towards a theory of rational defuzzification operators," in *Fuzzy Systems, 1993., Second IEEE International Conference On*. IEEE, 1993, pp. 1161–1166.
- [81] J. K. Eskildsen and K. Kristensen, "Enhancing importance-performance analysis," *International Journal of Productivity and Performance Management*, vol. 55, no. 1, pp. 40–60, 2006.
- [82] E. O. van Ravenswaay and J. R. Blend, "Consumer demand for ecolabeled apples: Results from econometric estimation," Michigan State University, Department of Agricultural, Food, and Resource Economics, Tech. Rep., 1999.
- [83] M. Laroche, J. Bergeron, and G. Barbaro-Forleo, "Targeting consumers who are willing to pay more for environmentally friendly products," *Journal of Consumer Marketing*, vol. 18, no. 6, pp. 503–520, 2001.
- [84] W. Nimom and J. Beghin, "Are eco-labels valuable? evidence from the apparel industry," *American Journal of Agricultural Economics*, vol. 81, no. 4, pp. 801–811, 1999.
- [85] K. Zander, H. Stolz, and U. Hamm, "Promising ethical arguments for product differentiation in the organic food sector: A mixed methods research approach," *Appetite*, vol. 62, pp. 133–142, 2013.

A Novel Consensus-seeking Approach in a Group Decision Making Environment

Michael Angelo B. Promentilla

Abstract—This paper proposes group consensus index (GCI) as a new consensus measure to assess the level of consensus in AHP-group decision making. GCI is a weighted consensus that incorporates the individual's influence on group decision while evaluating the compatibility or closeness of ratio-scale vectors between the individual and the group-aggregated priorities. In such a way, the quality of group decision that reflects the consensus situation can be examined in a more realistic way. The GCI is then used to guide the consensus-seeking process until the final consensus decision is achieved whether the situation necessitates the participants to compromise and modify their judgment or not. The provided numerical examples illustrate the feasibility of the proposed approach in which the results demonstrate its capability and flexibility to support consensus.

Index Terms—consensus measure, AHP, group decision making, group consensus index (GCI).

I. INTRODUCTION

THE importance of multiple criteria decision analysis (MCDA) in group decision making is increasingly being emphasized by many researchers. MCDA methods are currently being used as invaluable tools in handling interpersonal conflicts where the aim is to achieve consensus between the group members or at least reduce the amount of conflict among participating individuals [1]. For instance, the Analytic Hierarchy Process (AHP), one of the most widely used MCDA methods, has proven its viability to support group decisions in real-world problems (e.g., see Refs. [2], [3], [4]).

By using AHP, decision makers are able to structure the complex decision problem, develop measures of the utility or preference value from a ratio

scale, and synthesize both measures of tangible and intangible with respect to numerous conflicting objectives inherent in almost any decision [5]. In [6], the suitability of AHP for group decision making in different contexts was discussed including the different ways to reach the group decisions. Two of the popular methods of the AHP- group decision making being used in practice are [7], [8]: (1) the aggregation of individual judgments (AIJ) and (2) the aggregation of individual priorities (AIP). The AIJ combines each individual judgment by means of a mathematical aggregation operator resulting in a 'consensus' judgment in the pairwise comparison matrix. On the other hand, AIP involves the synthesizing of each individual's hierarchy and then aggregating the resulting overall priorities. It is also worthy to mention that AIJ or AIP should be used depending on whether the group behaves as a synergistic unit or as a collection of individuals [7]. Another issue for group aggregation is how to obtain the individual's weights if these participants are not to be equally weighted, as well as, how to use these weights in aggregation.

As AHP is extended to group decision making, the problem is no longer confined to the selection of the most preferred alternative among the set of nondominated alternatives according to one's individual preference structure. The analysis must be extended to multiple participants or decision makers such that the main issue is to find an alternative (or rank order of alternative) that is most acceptable to the group. Further, it is argued that it is premature to apply any mathematical technique that generates the 'consensus' preference vectors without knowing the current level of consensus associated with this group decision [9]. It is therefore imperative to develop similarity measures and consensus indicators that can be used to evaluate the consensus situation associated

M. A. B. Promentilla is with the Chemical Engineering Department, De La Salle University, Manila, Philippines.

with the mathematically group-aggregated priorities.

In this paper, we propose a new consensus measure as an alternative approach to measure the level of consensus associated with the group-aggregated priorities in the AHP framework. The ‘consensus measure’ here refers to the degree of group consensus as a function of individual’s influence weights and the compatibility of ratio-scale vectors between the individual preferences and group decision. Using this consensus measure, we also introduce a consensus-seeking process that can be used to guide the group decision making until a final decision with an acceptable level of consensus is reached. The rest of this paper has been structured as follows: Section 2 includes the background of the method, particularly the definition of compatibility quotient and group consensus index, followed by the description of the procedure for a consensus-seeking group decision making. Section 3 presents illustrative examples to demonstrate and explore the potential benefits of applying the method in AHP-group decision making. Finally, Section 4 highlights the conclusions of this paper.

II. BACKGROUND OF METHODOLOGY

A. Definition of Compatibility Quotient and Group Consensus Index

Consider the degree of compatibility or closeness between two ratio-scale vectors can be measured by a positive compatibility quotient (CQ) defined by the following equation:

$$CQ(w, u) = \frac{n^2}{c(w, u)} \quad (1)$$

where n is the number of the elements (e.g., alternatives) in the vector and $c(w, u)$ is the compatibility between two ratio scales w and u defined by the following equation:

$$c(w, u) = \sum_{i,j=1}^n \left(\frac{w_i}{w_j} \right) \left(\frac{u_j}{u_i} \right) \quad (2)$$

The compatibility metric $c(w, q)$ is originally introduced in [10] to measure how close the values are between two different vectors $w = (w_1, \dots, w_n)$ and $u = (u_1, \dots, u_n)$ derived from two pairwise comparison matrices. The minimum of $c(w, u)$ is n^2 and this holds true if and only if $w = u$. If the two

ratio-scale vectors are incompatible to each other to some extent, then $c(w, u) > n^2$.

For two-dimensional vectors (i.e., $n = 2$), we would have CQ values that range between 0.0 and 1.0 such that

$$CQ(w, v) = \frac{2^2}{\frac{w_1 v_1}{w_1 v_1} + \frac{w_2 v_1}{w_1 v_2} + \frac{w_1 v_2}{w_2 v_1} + \frac{w_2 v_2}{w_2 v_2}} \quad (3)$$

For example, suppose we have extreme ratio-scale vectors

$$w = \begin{bmatrix} 0.99 \\ 0.01 \end{bmatrix} \quad \text{and} \quad v = \begin{bmatrix} 0.01 \\ 0.99 \end{bmatrix}$$

Using equation (3), $CQ(w, v)$ would be equal to 0.0004. Accordingly, if we extend the concept of CQ as a similarity measure between the priority vectors ($n \geq 2$), the CQ value could be used to indicate how far or close the vectors are to each other. Thus, a CQ value of 1.0 indicates the perfect agreement between two priority vectors while a CQ value of less than one provides a measure of the extent of agreement between two priority vectors. The closer the two ratio-scale vectors are to each other, the closer is the value of the compatibility quotient (CQ) to one.

Note that the reciprocal of the compatibility quotient is equivalent to compatibility index (SI) in [10]. An SI value of greater than 1.00 but less than 1.10 is suggested to be the admissible bound for incompatibility between two ratio-scale vectors. The compatibility metric can also be used to compare each individual priority vector with the group composite priority vector derived from the aggregation of individual priorities [10], [11]. After assessing the compatibility of each individual with that of the group, one can suggest which individual is most incompatible with the group. Through reexamination and revision of one’s judgment, as well as, the recalculation of the individual priorities and group composite priorities, one may be able to obtain a group decision that is compatible with each member and reach an acceptable level of consensus. However, it is not clear yet how to measure such level of group consensus with the added consideration of the weight of influence of each participant in seeking consensus.

We can measure a positive CQ between the priorities derived from group aggregation and the individual participants. The closer the individual priority vector is to the group value, the nearer the value of

CQ to 1.00. We can then compute the group consensus index (GCI) based on the compatibility between the individual priority vector (u^k) of participant k and the group composite priority vector (v^G) such that

$$\text{GCI} = \sum_{k=1}^K \left[CQ(v^G, u^k) \times w_k \right] \quad (4)$$

where $\sum_k w_k = 1$.

Here, GCI refers to the group consensus index, n is the number of elements (e.g., the alternatives) in the vector, K is the total number of participants in the group, and w_k is the influence weight or degree of contribution of participant k in calculating the consensus. The GCI in this sense is a weighted consensus that considers the influence of individuals to group consensus while evaluating the compatibility or closeness between the ratio scale vectors of individual preferences and the group-aggregated priorities. If the individual participants are assumed to have equal influence on the final decision or recommendation, then GCI is just the average of CQ between the individual and the group-aggregated priorities. Otherwise, the degree of influence or contribution of participants as indicated by weight w_k is considered in calculating the consensus level.

This consensus measure can be used to monitor the degree to which a group is reaching consensus. As the level of group consensus is improved, the GCI value becomes nearer to 1.00. Moreover, the concept of compatibility quotient and GCI can also be used within the framework [9], [12] that analyzes the consensus-relevant preference data to support facilitation of the consensus building process. As group decision making may entail deliberation and negotiation among participants, one may need to temper one's view with those of the other participants in the group. Accordingly, the revision of judgment after group discussion may gradually narrow the differences among the participant's views or opinions leading to a satisfactory level of consensus.

On the other hand, there could be situations that allow participants to maintain their opinion without compromising, and yet a collective decision with high degree of 'consensus' must be attained. Consensus, in this sense, is a condition where it is possible for a group to reach a final decision that all participants can support in spite of their differing

opinions. This assumes that the participants do not have to agree and converge to a uniform opinion in order to reach consensus. This assumption is well grounded in research and real-life situation as elaborated in [13]. In such case, GCI can be used in a consensus-seeking process that could lead to the determination of a stable and reliable group decision. In this process, we measure the contribution of the individual members to the group decision by getting the difference of consensus level when the participant is included or not in the computation of the group-aggregated priorities. Weights assigned to participants are adjusted according to their contribution to the current consensus level. Then, these contributive weights are used to compute the new group-aggregated priorities and its corresponding GCI value. The weights assigned to participants and the group-aggregated priorities are updated in this iterative manner until the computed GCI value is acceptable to the group. In effect, the participants with more extreme or dissenting opinion will lose some of their weight (credibility, influence, etc.) to increase the GCI value. A similar approach is proposed in [13], where an order-based consensus measure is used in a group decision making under linguistic assessments. They argued that this consensus model supports the case in which an autocratic decision maker reaches a decision based on the recommendations of a diverse group of experts.

B. Procedure of the Consensus-seeking Group Decision Making Process

The consensus model presented in the next section differs from the one in Refs. [13] and [9], with the use of GCI as the consensus measure for the ratio-scale priorities derived from the AHP decision model. The consensus-seeking process entails that the group-aggregated priorities derived from AHP model must reflect the level of consensus as indicated by the GCI value. This assumes that a group can reach a final collective decision with a satisfactory level of consensus whether the situation necessitates the participants to compromise and modify their judgment or not. The proposed approach is described as follows:

Step 1: Using a common AHP model, derive the overall priorities of alternatives from each participant

(DM). Each participant provides his value judgment and the corresponding individual priorities are computed.

Step 2: Assign weights (w_k) to the participants. These weights can also be estimated from a priori information of participant's power to influence the decision and/or participant's relative importance in the group (e.g., see Refs. [8], [14], [15]). Otherwise, equal weighting of participants is initially assumed.

Step 3: Choose an aggregation operator. The most common aggregation operators found in the literature are the weighted geometric mean (WGM) and weighted arithmetic mean (WAM). Forman and Peniwati [7] showed that both geometric mean method (GMM) and weighted arithmetic mean method (WAMM) are suitable when aggregating individual priorities (AIP). However, they asserted that the geometric mean is more consistent with the interpretation of priorities as ratio-scale measures in AHP. In this study, either WGM or WAM can be used to aggregate the individual priority vectors (AIP) such that

WGM-AIP:

$$p_G(A_j) = \prod_{k=1}^K [p_k(A_j)]^{w_k} \quad (5)$$

Normalized WGM-AIP:

$$p_G(A_j) = \frac{\prod_{k=1}^K [p_k(A_j)]^{w_k}}{\sum_{j=1}^n \left(\prod_{k=1}^K [p_k(A_j)]^{w_k} \right)}$$

WAM-AIP:

$$p_G(A_j) = \sum_{k=1}^K w_k p_k(A_j) \quad (6)$$

where $p_G(A_j)$ refers to the group priority of alternative j , $p_k(A_j)$ to the individual's priority of alternative j , and n is the number of alternatives. Also, w_k is the weight of the individual k such that $\sum w_k = 1$ and K is the number of participants.

Step 4: Calculate the consensus level as indicated by GCI using equation (3). If the computed GCI value is acceptable for the group, then the desired consensus level is reached. Otherwise, the group may improve the GCI value after some analysis, discourse

and negotiation. Go to step 1 if revision of judgments is possible. Otherwise, go to step 5.

Step 5: Compute the contribution (Δ_j) of participant to the group consensus. The Δ_j is calculated by the following equations:

$$\text{GCI}_{\setminus\{j\}} = \sum_{k \in DM \setminus \{j\}} \left[CQ(v^{G \setminus j}, u_k) \times w'_k \right] \quad (7)$$

where

$$w'_k = \frac{w_k}{\sum_{i \in DM \setminus \{j\}} w_i}$$

$$\Delta_j = \text{GCI} - \text{GCI}_{\setminus\{j\}} \quad (8)$$

The $\text{GCI}_{\setminus\{j\}}$ and $v^{G \setminus j}$ refer to the group consensus level and group-aggregated priorities respectively without considering the j th participant (DM_j). The Δ_j is the contribution of the j th participant on the group priorities, which is the difference between the computed group consensus index with and without participant j . The higher the Δ_j is, the higher the contribution of the j th participant makes to the group.

Step 6: Adjust the weights of the participants according to their contribution to the group priorities using the following equations:

$$u_k^{r+1} = w_k^r (1 + \Delta_k^r)^p \quad (9)$$

$$w_k^{r+1} = \frac{u_k^{r+1}}{\sum_k u_k^{r+1}} \quad (10)$$

where w_k^r is the weight of participant k in the r th iteration. Parameter p is a nonnegative value set in the calculation to control the influence of the contribution of the participant on his weight. A p value of zero indicates that the weights of the participants are not adjusted according to their contribution to the group consensus. On the other hand, the higher the value of this parameter p , the faster the process approaches to the GCI value of 1.0.

Step 7: After adjusting the weights, we recalculate the group priorities and consensus level (GCI). The process of adjusting contributive weights of participants continues until the desired consensus level is reached.

III. APPLICATION OF GCI IN AHP-GROUP DECISION MAKING

A. An Illustrative Example

Consider the actual preference data obtained from five independent participants (DM_k) as shown in Table 1 [16]. This is the individual priorities of alternatives from an AHP model that evaluates the remedy options for a contaminated site in Japan. The group preference vector was obtained by aggregating the individual priorities with the assumption that each participant has an equal weight or contribution, i.e., $w_k = 0.20$. In other words, the group aggregation operator WAM and WGM are equivalent to arithmetic mean and geometric mean of the individual priorities, respectively.

From inspection of Table 1, it is logical to assume that A1 would be the most acceptable to the group based on a majority or plurality rule. However, the derived ratio-scale priorities provide not only the rank order of alternatives but also the cardinal information of the intensity of preference. Results indicate how the choice of method of aggregation for these individual priorities may lead to a different set of rank order of group priorities. Accordingly, A1 is ranked first followed by A2 when weighted arithmetic-mean (WAM-AIP) operator is used. On the other hand, A2 is ranked first followed by A1 when weighted geometric-mean (WGM-AIP) operator is used. Note that both types of aggregation are mathematically sound but it is not clear which one would provide the acceptable group priorities or rank order of alternatives.

In this example, the relatively high intensity of DM3's preference of A2 over the other alternatives may have a significant impact on the computed group priorities. This extreme and dissenting opinion seems to distort the group-aggregated priorities and can be interpreted as a group decision derived from a radical compromise. However, this mathematically-aggregated group decision may not be supported by all participants if there is such unwillingness to compromise. It would be too soon to conclude that the said group-aggregated priority vector represents the final consensus decision. Hence, it would be advantageous to provide a transparent way to evaluate the quality of the group decision associated with the

DM_k	DM1	DM2	DM3	DM4	DM5
DM1	1	0.904	0.200	$\approx 1.000^*$	0.941
DM2	0.904	1	0.129	0.913	0.917
DM3	0.200	0.129	1	0.194	0.231
DM4	$\approx 1.000^*$	0.913	0.194	1	0.942
DM5	0.941	0.917	0.231	0.942	1

Note: $^*0.9997$

Fig. 1. The compatibility matrix for the preference data in Table 1.

group-aggregated priorities by assessing the group consensus level.

B. Consensus-seeking Phase with the Revision of Judgments

Let us suppose that the weighted arithmetic mean is selected as the aggregation operator for the individual priorities. Table 2 describes the compatibility of each participant's priorities to the group-aggregated priorities (WAM-AIP) and the group consensus index. As expected, DM3's priority vector is the most incompatible with the group priority vector as indicated by a relatively lower CQ among the participants.

It would also be interesting to measure the degree of agreement between these participants as described in the compatibility matrix (Figure 1). The compatibility matrix shows the compatibility quotient between participants whose preference vectors are described in Table 1. For example, this confirms that DM3 had strong disagreement with the other participants. The CQ between DM3 and DM2 was the lowest because of their relatively extreme priorities. On the other hand, DM4 had relatively good agreement with the other participants except DM3. The CQ between DM1 and DM4 was nearly 1 because of the obvious closeness of their pertinent priorities. DM4 had also good agreement with DM2 and DM5 in spite of their differences in the rank order of A2 and A3, as DM4's relative preference of A2 over A3 is relatively small.

From the compatibility matrix, we could also compute for an interpersonal consensus index (ICI) to indicate the relative agreement of the participant with the other participants as shown in Figure 2. The ICI of each participant is obtained by averaging the

TABLE I
THE INDIVIDUAL PRIORITIES AND THE GROUP-AGGREGATED PRIORITIES OF ALTERNATIVES^a

	DM1	DM2	DM3	DM4	DM5	WAM ^b	WGM ^c
A1	0.471 (1)	0.497 (1)	0.044 (3)	0.476 (1)	0.373 (1)	0.372 (1)	0.332 (2)
A2	0.272 (2)	0.166 (3)	0.773 (1)	0.264 (2)	0.258 (3)	0.346 (2)	0.349 (1)
A3	0.257 (3)	0.337 (2)	0.183 (2)	0.260 (3)	0.369 (2)	0.281 (3)	0.319 (3)

^athe rank order is enclosed in the parenthesis

^baggregation of individual priorities by arithmetic mean

^caggregation of individual priorities by (normalized) geometric mean

TABLE II
THE INDIVIDUAL PRIORITIES AND THE GROUP-AGGREGATED PRIORITIES OF ALTERNATIVES^a

WAM	DM1	DM2	DM3	DM4	DM5	GCI
CQ(G,DM _i)	0.961	0.814	0.289	0.956	0.948	0.794

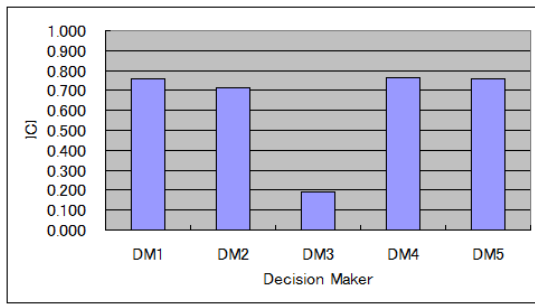

Fig. 2. The interpersonal consensus index of each participant.

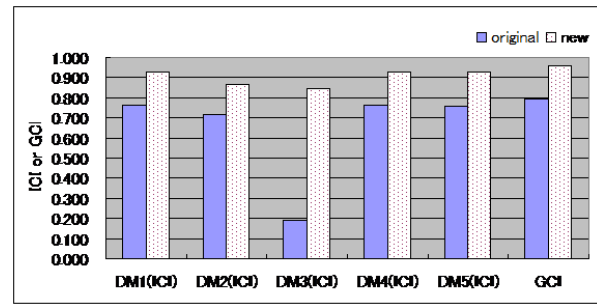

Fig. 3. Comparison of consensus measures obtained from the original and new set of preference vectors.

interpersonal compatibility quotient with the other participants such that

$$ICQ_k = \left\{ \frac{1}{K-1} \sum_{l=1}^K (CQ|_{(k,l)} - 1) \right\} \quad (11)$$

Such information could facilitate the group discussion and identify key participants who have the potential for furthering the cause of consensus building. The lower the ICI of a participant (e.g., DM3) is, the greater the potential for this individual to reconsider his judgment. On the other hand, those individuals (e.g., DM4) with higher ICI would have high potential for consensus building around their own position.

Let us suppose that after the group engages in the deliberation, only DM3 reconsiders his value judgment while the rest maintain their opinion. For example, DM3 may not have to compromise his original preference order of the alternatives but he is willing to temper his extreme views resulting to

a more moderate preference value (see Table 3). In Table 3, the new set of individual preference vectors and the group-aggregated priorities are shown. In this new set of preference vectors, both aggregation operators yield a similar rank order (A1 > A3 > A2) of group-aggregated priorities. Figure 3 compares the GCI and ICI of this new set of preference vectors (Table 3) to the original set of preference vectors described in Table 1. This figure shows the improvement of consensus level associated with the group-aggregated priorities, as well as, the agreement between participants after DM3 reconsidered his view. If the group decided that such degree of improvement of the consensus level from 0.794 to 0.957 would be satisfactory, then the group may recommend the group-aggregated priorities as the final consensus decision. Otherwise, another round of group discussion and evaluation may be considered until the desired level of group consensus is reached.

TABLE III
THE NEW SET OF INDIVIDUAL PRIORITIES AND THE GROUP-AGGREGATED PRIORITIES OF ALTERNATIVES^a

	DM1	DM2	DM3	DM4	DM5	WAM ^b	WGM ^c
A1	0.471 (1)	0.497 (1)	0.287 (3)	0.476 (1)	0.374 (1)	0.421 (1)	0.421 (1)
A2	0.272 (2)	0.166 (3)	0.387 (1)	0.264 (2)	0.258 (3)	0.269 (2)	0.266 (3)
A3	0.257 (3)	0.336 (2)	0.326 (2)	0.260 (3)	0.369 (2)	0.310 (2)	0.313 (2)

^athe rank order is enclosed in the parenthesis

^baggregation of individual priorities by arithmetic mean

^caggregation of individual priorities by (normalized) geometric mean

C. Consensus-seeking Phase without the Revisions of Judgments

Although one of objectives of group decision making is consensus building, the participants may not be willing to modify their opinion. There are also some situations where participants would agree to disagree and express their desire to reach a collective decision. In this case, the following consensus model addresses the individual's influence on the final consensus decision, which depends on the pattern of contribution of the individual participants. For example, let us consider the original preference data from Table 1. To measure the contributions of the individual group members, we aggregate the individual priorities without one participant and use equations (7) and (8). Table 4 shows the new group-aggregated priorities and the corresponding group consensus level without a particular participant. Using these results, the pattern of contributions of the participants toward the current consensus level ($GCI = 0.794$) is described in Table 5. A negative value of Δ_j (-0.1815) indicates that DM3's set of priorities is the contributing factor that lowers the level of consensus associated with the initially computed group-aggregated priorities.

After calculating the contribution of individual participant Δ_j to consensus level, we apply equations (9) and (10) to adjust the weights. A negative contribution would decrease the participant's weight from the previously assigned weight while a positive contribution would do otherwise. Initially (i.e., at $r = 0$), the weighting vector of the participants is assigned to be $w = [0.20, 0.20, 0.20, 0.20, 0.20]$. Table 6 shows the change of weights of participants during the first three iterations while Table 7 shows the corresponding change in the computed group-aggregated priorities. For example, the con-

tributive weight of participant DM3 decreases while the weights of other participants increase. In effect, the priority weight of A2 decreases while that of A1 and A3 increases. This is the result of DM3 contributing less to the group-aggregated priorities. With these changes of the contributive weights of participants, the measured group consensus level associated with the group decision also increases. This iterative process continues until a satisfactory value of GCI is reached.

Figure 4 shows how GCI improves from the initial value of 0.794 after 50 iterations while the contributive weights of the five participants are adjusted accordingly. This figure also describes the corresponding group-aggregated priorities using the weighted arithmetic mean (WAM-AIP) operator. To increase the level of consensus, the weight of participant DM3 whose set of priorities is the most incompatible with the group is reduced instantly. To increase further the GCI value, the next most incompatible participant to the group is also reduced as the iteration continues. In this case, contributive weight of DM3 and DM5 were observed to drop after the 4th and 18th iterations, respectively. Moreover, this may imply that as the process approach a certain degree of consensus, those participants who tend to be in the majority subgroup (e.g., DM4 and DM1) sharing similar preferences would be assigned relatively higher contributive weights while those with the minorities having peculiarly different preferences would be assigned relatively lower contributive weights. It should be noted that the meaning of iteration here can be interpreted as a repeated process of adjusting the participant's contributive weights to gradually improve the consensus level in spite of differing intensity of preferences among group participants. Eventually, if we continue the iteration to reach an idealized consensus level ($GCI = 1$)

TABLE IV
THE GROUP-AGGREGATED PRIORITIES AND PARTIAL GROUP CONSENSUS INDEX WITHOUT A PARTICULAR PARTICIPANT DM

	WAM-AIP (aggregated policies)				
	w/o DM1	w/o DM2	w/o DM3	w/o DM4	w/o DM5
A1	0.348	0.341	0.454	0.347	0.372
A2	0.365	0.392	0.240	0.367	0.369
A3	0.287	0.267	0.306	0.286	0.259
$GCI_{\setminus\{j\}}$	0.743	0.771	0.975	0.744	0.745

TABLE V
CONTRIBUTION OF INDIVIDUAL PARTICIPANT TO GROUP CONSENSUS

J	DM1	DM2	DM3	DM4	DM5
Δ_j	0.0503	0.0223	-0.1815	0.0496	0.0491

TABLE VI
WEIGHTS OF PARTICIPANTS AT FIRST THREE ITERATIONS OF AUTOMATIC UPDATING OF WEIGHTS^a

r	DM1	DM2	DM3	DM4	DM5	GCI
0	0.2000	0.2000	0.2000	0.2000	0.2000	0.794
1	0.2105	0.2049	0.1640	0.2104	0.2102	0.827
2	0.2184	0.2071	0.1386	0.2182	0.2177	0.851
3	0.2246	0.2078	0.1199	0.2244	0.2233	0.869

^a parameter p is set to 1.0

TABLE VII
GROUP-AGGREGATED PRIORITIES OF ALTERNATIVES AT FIRST THREE ITERATIONS OF AUTOMATIC UPDATING OF WEIGHTS

r	A1	A2	A3	GCI
0	0.372	0.346	0.281	0.794
1	0.387	0.328	0.285	0.827
2	0.397	0.315	0.288	0.851
3	0.405	0.305	0.290	0.869

with participants having different set of priorities, all participants but one are completely discounted.

As GCI increases while adjusting the contributive weights of participants, the group-aggregated priorities of alternatives are updated (see Figure 4) resulting to a more stable and reliable group decision. The final consensus decision can then be obtained that would reflect a satisfactory level of consensus. For example, as GCI approaches the value of 0.95, the intensity of preferences of the alternatives is changing, resulting to a different rank order of alternatives ($A1 > A3 > A2$) as compared to the initial condition ($A1 > A2 > A3$).

Similar calculations of the same preference data were also conducted using the weighted geometric mean (WGM-AIP) operator. Figure 5 describes how the weights of participants and group-aggregated

priorities (WGM-AIP) are changing while the GCI value increases. The figure when compared to Figure 4 indicates the similar rank order ($A1 > A3 > A2$) of the alternatives as GCI approaches the value of 0.95. Although A2 is ranked first because of DM3's extreme preference on A2 over the other alternatives, it slides down to the third rank as the DM3's weight decreases along with the increase of GCI.

The consensus-seeking process based on GCI could therefore provide not only the explicit measure of consensus level, but also a robust rank order of the alternatives regardless of the chosen mathematical aggregation operator (i.e. weighted arithmetic or geometric mean method). Note that these results would therefore guide the group decision-making process to find a reasonable value of the group-aggregated priorities without forcing anyone to modify his opin-

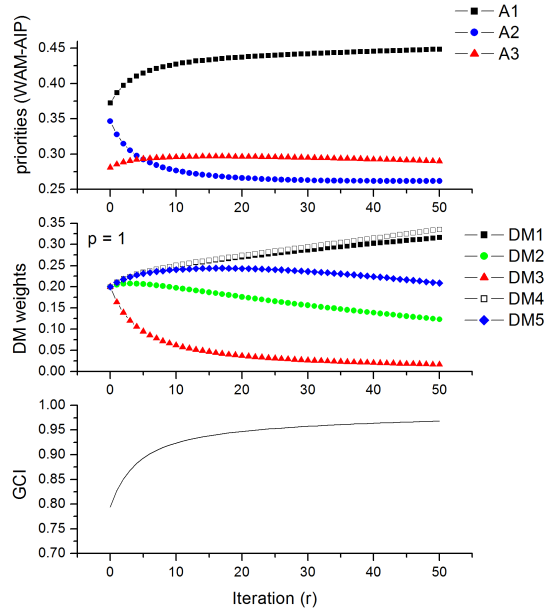

Fig. 4. An example of output from the consensus-seeking model using the weighted arithmetic mean as aggregation operator.

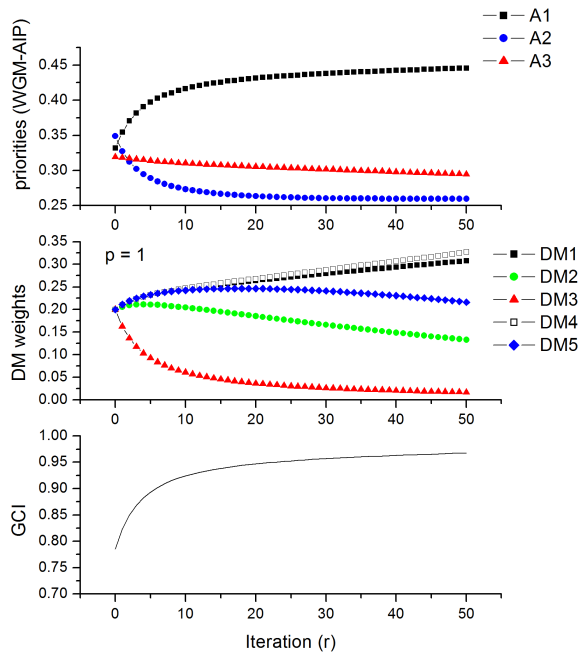

Fig. 5. An example of output from the consensus-seeking model using the weighted geometric mean as aggregation operator.

ion. For example, the rank order of alternatives ($A1 > A3 > A2$) obtained from the consensus model while improving the GCI value would seem to be more reasonable than the rank order obtained from

the usual arithmetic ($A > A2 > A3$) or geometric ($A2 > A1 > A3$) averaging of the individual priorities. Thus, the role of this consensus-seeking process in group decision making can be viewed as a final arbiter that determines the reasonable group-aggregated priorities if the desired level of consensus is unattainable during the consensus-seeking phase of deliberations.

It should be noted that the group may have to define the stopping rules of the process including the threshold value of GCI at the onset of the formal group decision making. For instance, one could set the desired GCI value such that it must be greater than 0.90 or 0.95, or even 0.99 to end the consensus-seeking process. However, this study does not recommend any specific threshold value for GCI that could be used as a stopping rule. The computed GCI value in the consensus-seeking process may be satisfactory or not depending on the discretion of the group. In this context, the proposed process should not be seen as a rigid method to be followed but as some kind of decision guidance. Decision guidance can be described as being suggestive in a way that it recommends a specific course of action or just being informative that could support consensus building [9]. For instance, the results from this consensus-seeking model could provide a new dimension to the analysis and serve as motivation for participants to reconsider their opinion based on the consensus-relevant information.

Note that the consensus-seeking process can be applied to group decision making under expert judgment or group participation. The former entails making a decision by developing alternative solutions and selecting the optimal one while the latter entails making a decision from a group which has common interest or problem like a community, a committee, or an organization [17]. In this example, DM3 was identified as the most incompatible participant in the group having an extremely dissenting opinion. This led to a GCI value associated with the group-aggregated priorities that may be deemed unsatisfactory. In the case of an expert judgment process, the autocratic or formal decision maker may have to discount DM3's opinion in obtaining the final recommendation with high degree of consensus. This behavior has some valid psychological motivations which are described elsewhere [18]. On the other

hand, in group participation where each one is allowed to change his opinion after a series of discussions or disclosure of information, a participant such as DM3 would lose some of its contributive weights to the group-aggregated priorities if he decided to remain stern with his dissenting opinion. Accordingly, any non-cooperative participant who tries to subvert the consensus process by deliberately shifting their priority weights to an extreme could have the risk of being excluded from the process or having very little impact on the group decision. Hence, this consensus-seeking model would identify and discourage such kind of strategic manipulations in group decision making.

IV. CONCLUSION

This study proposed GCI as a new consensus measure that can be applied to a consensus-seeking process in AHP-group decision making. AHP is widely being used as a formal yet intuitive method for individual participants to explore their own perceptions of the decision problem and at the same time, as a means of communicating their perceptions to each other. With multiple participants, whether they are the formal decision makers or experts, the decision making process may have to require a certain level of consensus in spite of the diversity of judgments and subjective perceptions of reality. Using GCI, we can measure the degree of consensus associated with the group-aggregated priorities and evaluate the quality of such group decision through a formal structured decision process. GCI considers the influence of individuals to group consensus while evaluating the compatibility or closeness between the ratio scale vectors of individual preferences and the group-aggregated priorities. To our knowledge, this is the first attempt to apply the concept of compatibility between ratio-scale vectors in a weighted consensus measure such as GCI.

We have also demonstrated with numerical examples how a consensus-seeking process based on GCI can be used to search for a final consensus decision that is more stable and reliable. First, it can deal with 'consensus' situation that involves an interactive process wherein the participants are encouraged to modify their judgment to reach a closer agreement in their preference vector. The GCI can be applied to transparently monitor and document the

progress of consensus building process. Secondly, it can deal with 'consensus' situation which requires final arbitration in order to reach a collective decision without forcing the participants to compromise and change their views. If the current consensus level is deemed unsatisfactory, the consensus-seeking process improves the GCI value by adjusting the weights of the participant according to their contribution to consensus. Those participants who tend to be in the majority subgroup sharing similar preferences would be assigned relatively higher contributive weights while those with the minorities having peculiarly different and extreme preferences would be assigned relatively lower contributive weights. As GCI approaches to a satisfactory level, the group-aggregated priorities are updated leading to a more reasonable collective decision.

The information derived from the consensus-seeking process can also serve as decision guidance. First, this could guide the formal decision maker on how to integrate the experts' differing opinions into a final collective decision. Secondly, this can flexibly be used by a facilitator or analyst such that the model outputs could serve as starting point or orientation for group discussion. The consensus-relevant information provided by the model can therefore be used along with NGT (Nominal Group Technique) or any Delphi-like procedure. Moreover, the proposed approach can be extended to Analytic Network Process (ANP), a generalized form of AHP [11]; as well as, to other decision models that measure the decision maker's preference value in terms of ratio-scale vectors. Although this research is still at the conceptual stage, we believe that future works along these lines will provide improved AHP/ANP-based decision support tools for group decision making and negotiation process.

REFERENCES

- [1] N. F. Matsatsinis and A. P. Samaras, "MCda and preference disaggregation in group decision support systems," *European Journal of Operational Research*, vol. 130, no. 2, pp. 414–429, 2001.
- [2] V. S. Lai, R. P. Trueblood, and B. K. Wong, "Software selection: A case study of the application of the analytical hierarchical process to the selection of a multimedia authoring system," *Information & Management*, vol. 36, no. 4, pp. 221–232, 1999.

- [3] V. S. Lai, B. K. Wong, and W. Cheung, "Group decision making in a multiple criteria environment: A case using the ahp in software selection," *European Journal of Operational Research*, vol. 137, no. 1, pp. 134–144, 2002.
- [4] M. C. Tam and V. R. Tummala, "An application of the ahp in vendor selection of a telecommunications system," *Omega*, vol. 29, no. 2, pp. 171–182, 2001.
- [5] T. L. Saaty, *The Analytic Hierarchy Process*. New York: McGraw-Hill, 1980.
- [6] R. F. Dyer and E. H. Forman, "Group decision support with the analytic hierarchy process," *Decision Support Systems*, vol. 8, no. 2, pp. 99–124, 1992.
- [7] E. Forman and K. Peniwati, "Aggregating individual judgments and priorities with the analytic hierarchy process," *European Journal of Operational Research*, vol. 108, no. 1, pp. 165–169, 1998.
- [8] R. Ramanathan and L. Ganesh, "Group preference aggregation methods employed in AHP: An evaluation and an intrinsic process for deriving members' weightages," *European Journal of Operational Research*, vol. 79, no. 2, pp. 249–265, 1994.
- [9] N. Bryson, "Group decision-making and the analytic hierarchy process: Exploring the consensus-relevant information content," *Computers & Operations Research*, vol. 23, no. 1, pp. 27–35, 1996.
- [10] T. Saaty, "A ratio scale metric and the compatibility of ratio scales: The possibility of arrow's impossibility theorem," *Applied Mathematics Letters*, vol. 7, no. 6, pp. 51–57, 1994.
- [11] —, *Decision Making with Dependence and Feedback: The Analytic Network Process : The Organization and Prioritization of Complexity*, ser. Analytic hierarchy process series. RWS Publications, 2001. [Online]. Available: <https://books.google.co.jp/books?id=MGpaAAAAYAAJ>
- [12] O. K. Ngwenyama, N. Bryson, and A. Mobolurin, "Supporting facilitation in group support systems: Techniques for analyzing consensus relevant data," *Decision Support Systems*, vol. 16, no. 2, pp. 155–168, 1996.
- [13] D. Ben-Arieh and Z. Chen, "Linguistic-labels aggregation and consensus measure for autocratic decision making using group recommendations," *Systems, Man and Cybernetics, Part A: Systems and Humans, IEEE Transactions On*, vol. 36, no. 3, pp. 558–568, 2006.
- [14] H. M. Regan, M. Colyvan, and L. Markovchick-Nicholls, "A formal model for consensus and negotiation in environmental management," *Journal of Environmental Management*, vol. 80, no. 2, pp. 167–176, 2006.
- [15] R. Van den Honert, "Decisional power in group decision making: A note on the allocation of group members' weights in the multiplicative ahp and smart," *Group Decision and Negotiation*, vol. 10, no. 3, pp. 275–286, 2001.
- [16] M. A. B. Promentilla, "Development of a multiple criteria decision making method for remedial countermeasures of contaminated sites," Ph.D. dissertation, Hokkaido University, Hokkaido, Japan, 2006.
- [17] C.-L. Hwang and M.-J. Lin, *Group Decision Making Under Multiple Criteria: Methods and Applications*. Springer Science & Business Media, 2012, vol. 281.
- [18] C. Harries, I. Yaniv, and N. Harvey, "Combining advice: The weight of a dissenting opinion in the consensus," *Journal of Behavioral Decision Making*, vol. 17, no. 5, pp. 333–348, 2004.

Design of an All-MOS Temperature Sensor with an 8-bit Incremental Delta-Sigma ADC on a 0.18 μ m Technology

Juan Gabriel Briones, Gino Marasigan, Jan Bryan Pascasio, Rachel Marie Dalisay, Joseph Ponce, Donato David, and Alexander Abad

Abstract—This study focused on the design and characterization of a Temperature Sensor with an 8-bit Low-Voltage Incremental Delta-Sigma Analog-to-Digital Converter (ADC). The Proportional to Absolute Temperature (PTAT) part of an All-MOS bandgap voltage reference was utilized as the Temperature Sensor. The design was implemented using 0.18 μ m CMOS Technology. The temperature sensor and voltage reference operates at 2.5-V supply voltage while the ADC part operates on a low voltage 1-Volt supply. The circuit design can operate from 0°C to 85°C with a temperature coefficient of 0.933mV/°C or 2.5LSB/°C and was implemented and simulated using Synopsys Tools.

Index Terms—bandgap voltage reference, temperature sensor, incremental sigma-delta, analog-to-digital converter.

I. INTRODUCTION

THROUGH the continuous and fast pace development in technology, the use of sensors has been widely used in the structures of high technology machineries and in the field of electronics. It is because of the fact that sensors detect physical phenomena and convert these to corresponding electrical signals that are relatively measurable [1]. One important parameter in a given circuit, device, or system is its temperature. Maintaining and monitoring the proper temperature is extremely important in a given system since having changes in

J. G. Briones, G. Marasigan, J. B. Pascasio, R. M. Dalisay, J. Ponce, D. David were students of the Electronics and Communications Engineering Department, De La Salle University, Manila, Philippines

A. Abad is with the Electronics and Communications Engineering Department, De La Salle University, Manila, Philippines

temperature can affect the conditions of the components; hence sustaining and maintaining the status of an electronic product, temperature sensors are evident. Temperature sensor is the perfect measuring apparatus to address such problems for it has been a growing demand on Very Large Scale Integration (VLSI), automotive, and wireless sensing application [2]. Temperature sensors fall into two categories: those that produce a voltage naturally as an indicator of temperature, and those that produce some other physical response that must be converted to a voltage for measurement [1]. These temperature sensors are often integrated into microprocessors and memory chips to control the mode or speed of operation based on the temperature of the system which is why the need to decrease its size is important. It also has low power consumption which contributes in power grid integrity and alleviates self-heating issues. Moreover, temperature sensors can also be used in other electrical applications that require immediate temperature check-up such as machines and motors with cooling and heating systems that entails control.

This study focuses on the design of an Integrated Circuit that is composed of a Temperature Sensor and Analog-to-Digital Converter all together in one chip area.

II. THEORETICAL FRAMEWORK & DESIGN CONSIDERATION

A. Top Level Design

Fig. 1 shows the system block diagram of the whole design of a temperature sensor with an 8-bit low voltage Incremental Delta-Sigma Analog to Digital Converter. It is composed of a Temperature

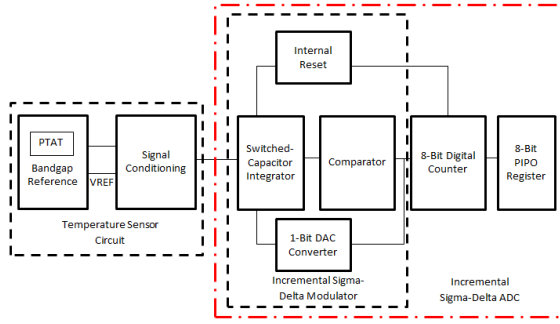

Fig. 1. System block diagram.

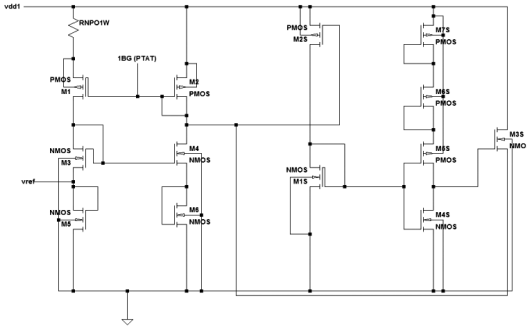

Fig. 2. Voltage reference circuit [3].

Sensor Block, Incremental Delta-Sigma Modulator, and an 8-bit Digital Counter with 8-bit Parallel-in Parallel-out (PIPO) register for its output.

B. Temperature Sensor

The temperature sensor of the system comes from the Proportional to Absolute Temperature (PTAT) node of a bandgap voltage reference based from the design of [3] shown in Fig. 2. This voltage reference is composed of a Power Supply Stabilizer block, Current Source block, Temperature Coefficient Tuning Element, and the Start-up circuit that work in harmony to achieve low dependence towards temperature and supply voltage (VDD) variations resulting to stable voltage reference output (VREF). This is an All-MOS Operational Amplifier-less voltage reference.

The well-known simplified equation of MOS operating in strong inversion is shown in Equation 1. The parameters affected by temperature are the electron mobility μ_n and the threshold voltage V_{TH} . Equations (1) and (2) show the mathematical relationships of μ_n and V_{TH} with respect to temperature. Where

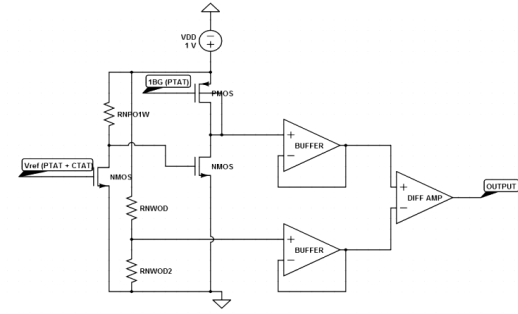

Fig. 3. Block diagram of signal conditioning circuit.

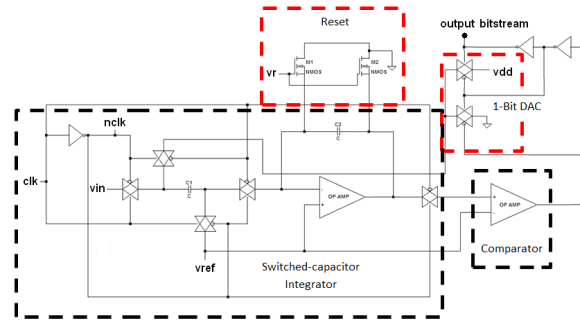

Fig. 4. Incremental delta-sigma modulator.

$T_0 = 300K$ and α_{vt} is the thermal coefficient of the threshold voltage measure at $T = T_0$. The derivative of V_{GS} with respect to the temperature is shown in Equation (3).

$$\mu_n = \mu_{n0} \left(\frac{T}{T_0} \right)^{\alpha_\mu} \quad (1)$$

$$V_{TH} = V_{TH0} + \alpha_{vt}(T - T_0) \quad (2)$$

$$\frac{\partial V_{GS}}{\partial T} = \sqrt{\frac{2I_D}{\mu_n C'_{ox}} \frac{L}{W}} \left(\frac{\alpha_I}{I_D} - \frac{\alpha_\mu}{T} \right) + \alpha_{vt} \quad (3)$$

α_I is the thermal coefficient of I_D , which has been assumed to be linearly related with temperature. Equation (3) shows that the rate of change of V_{GS} with respect to temperature is dependent in the drain current as well as on its temperature coefficient. Equations (1)-(3) are based from [4].

A signal conditioning circuit, shown in Fig. 3, optimizes the PTAT output voltage of the bandgap reference by configuring the analog voltage from 0 to 1V, ideally, with respect to temperature. The output voltage of the signal conditioning circuit in the actual

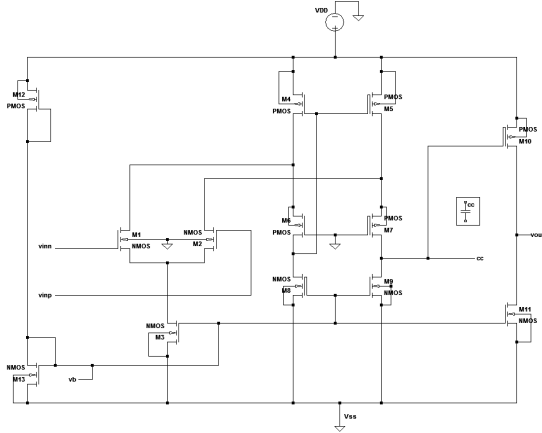

Fig. 5. Operational amplifier [6].

design has a working range from 27.9 mV to 821 mV with respect to temperature range from 0°C to 85°C.

C. Incremental Delta-Sigma Modulator

Fig. 4 shows the Incremental Delta-Sigma modulator. It is very similar to the delta-sigma modulator of [5] with an additional reset block. It is composed of a switched-capacitor integrator, comparator, 1-bit Digital to Analog Converter (DAC), and a Reset circuit.

Fig. 5 shows the Operational Amplifier adopted from [6] that was used in the integrator as well as on the comparator block of the modulator.

Shown in Table 1 are the results of Opamp Characterization. The design was simulated in the different corner libraries namely: typical-typical, fast-fast, fast-slow, slow-fast, and slow-slow.

D. 8-Bit Digital Counter with PIPO Register

The last stage of the whole system is an 8-Bit Digital Counter based from [7] with Parallel-in Parallel-out (PIPO) Register that will store the output data. The 8-bit counter, shown in Fig. 6, is in-charge of converting the bit stream to its digital equivalent code. It counts how many high states of bit stream within a given period of time. In this design, the period is 256 us. The digital output is dependent on the pulse density of the bit stream. The conversion is finished after 256 clock cycles after the reset has turned off.

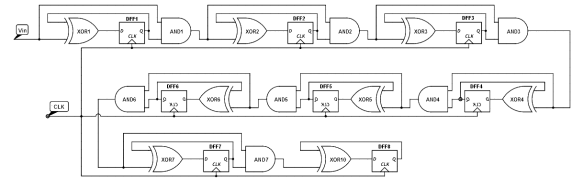

Fig. 6. 8-bit counter [7].

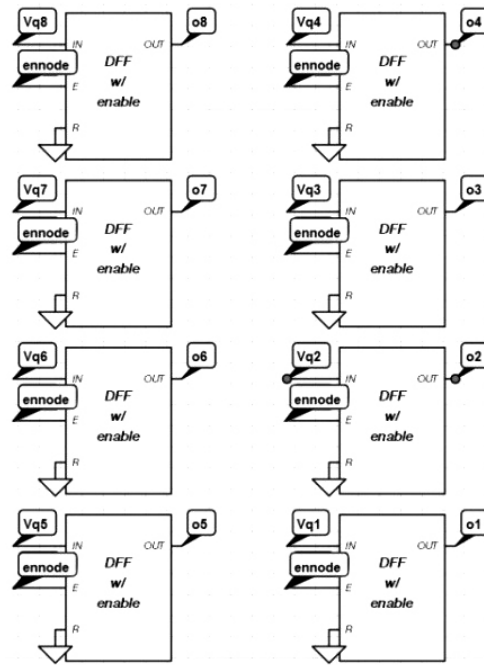

Fig. 7. Register circuit.

The register circuit shown in Fig. 7 has been designed to be used as a latch in order to store the read digital code.

Fig. 8 shows the modified D-FlipFlop (DFF) design wherein enable pin has been incorporated. The enable circuit is enclosed by a dashed line.

Fig. 9 shows the design of the internal reset circuit wherein additional logic gates and an 8-bit digital counter are used for resetting the whole system after one conversion time.

III. RESULTS AND DISCUSSION

A. Temperature Sensor Circuit Output

Fig. 10 displays the obtained PTAT and Complementary to Absolute Temperature (CTAT) output of the bandgap reference circuit.

TABLE I
RESULTS OF OP-AMP CHARACTERIZATION

	TT	FF	FS	SF	SS
Gain (dB)	62.3	53.4	63.2	65.4	71.2
CM (dB)	-19.1	-21.1	-16.2	-12.7	-12.4
CMRR (dB)	81.9	75.2	80.1	78.5	83.8
DC Offset (mV)	-0.102	-0.245	-0.112	-0.0942	-0.0495
ICMR (mV)	0 - 0.85	0 - 0.91	0 - 0.801	0 - 0.85	0 - 0.885
PSRR (dB)	61.6	63.5	62.2	63	68
SR (V/μs)	51	57.01	48	46.44	43.7

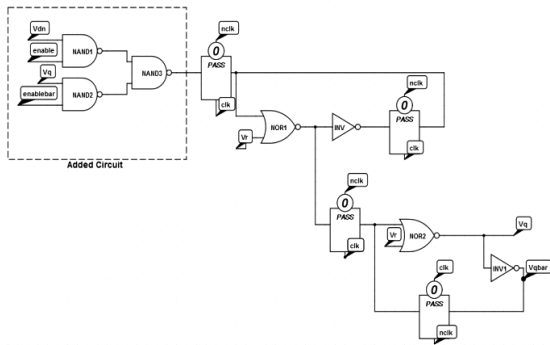

Fig. 8. DFF with enable.

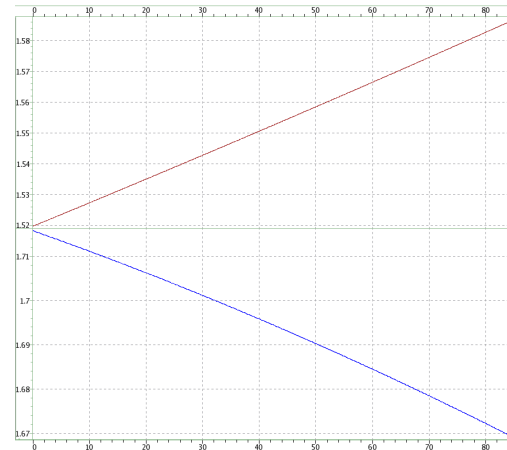

Fig. 10. PTAT and CTAT output.

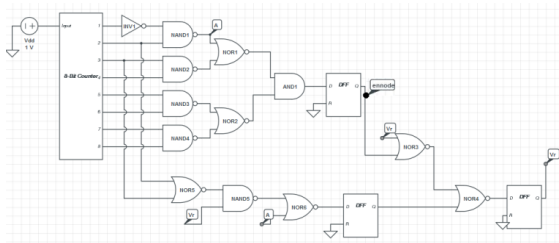

Fig. 9. Reset circuit.

PTAT output is used as the input to the incremental sigma delta ADC since it has a linear response with respect to temperature. Equation (4) displays the equation of the linearity of PTAT.

$$y = 0.0008x + 1.52 \tag{4}$$

Fig. 11 shows the capability of the bandgap reference to have a stable output with respect to temperature variations. Temperature was varied from 0°C to 85°C and the generated V_{ref} is parabolic in nature that has a range of 942.4mV to 944.18mV. The V_{ref} output change is just 1.78mV from 0°C to 85°C.

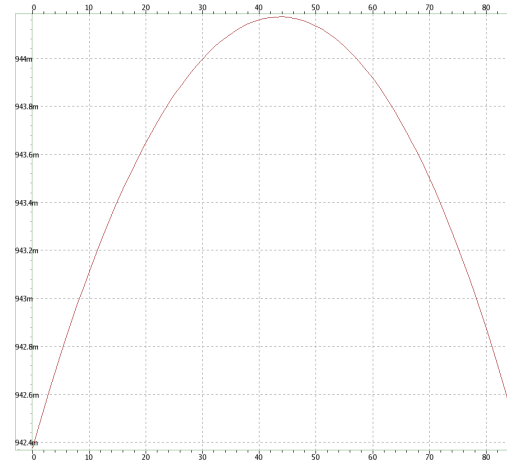

Fig. 11. V_{ref} output.

Shown in Fig. 12 is the simulation results of bandgap reference voltage at the different corner libraries when the temperature was varied from 0°C to 85°C.

Fig. 13 shows the V_{ref} output voltage in five

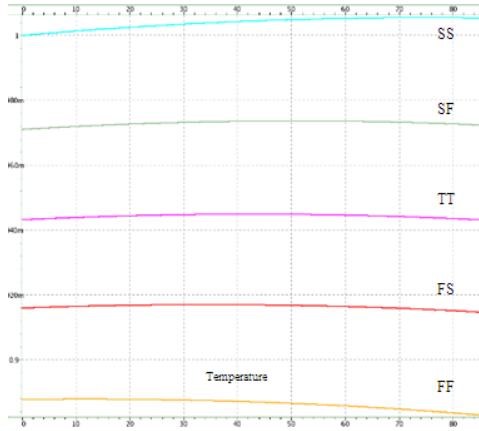

Fig. 12. Temperature sweep in five process corners.

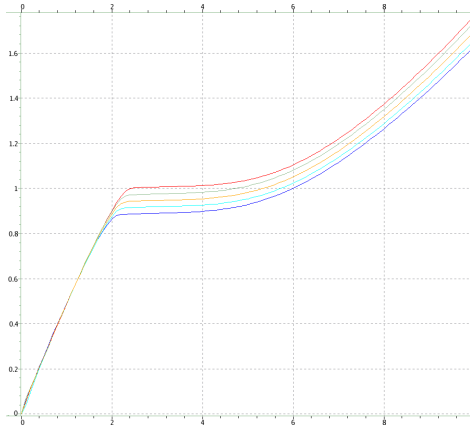

Fig. 13. Voltage sweep in five process corners.

Process Corners, SS, SF, TT, FS, FF respectively as the input voltage is varied from 0V to 5V. The output is almost flat line from 2.4V to 4.14V.

Fig. 14 is the output of the temperature sensor with conditioning circuit simulated with sweeping temperature. Using the spice command “`.dc temp 0 85 1`”, the simulation performed a temperature sweep from 0 to 85°C with a temperature step of 1°C. The output voltage of the temperature sensor with signal conditioning circuit varies linearly from 27.9 mV to 821 mV with respect to temperature from 0°C to 85°C.

Table 2 shows the results of line regulation simulations at the different corner libraries. The range of line regulation variation is considering the five corners is from 7.55814 mV/V to 8.13953 mV/V.

Table 3 shows the results of Temperature Coefficient simulations at the different corner libraries. The

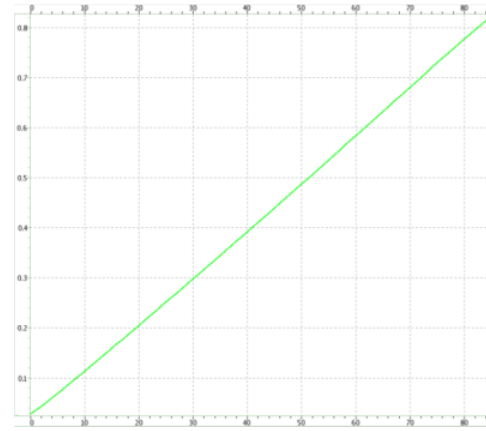

Fig. 14. Output of signal conditioning circuit with respect to temperature.

range of Temperature Coefficient considering the five library corner is from 24.8988 ppm/°C to 66.2427 ppm/°C.

B. Incremental Delta-Sigma Modulator Output

Fig. 15 shows the output of the Sigma-Delta Modulator with a triangular wave as the input. The output is a pulse-density modulated signal represented by the blue waveform and the input signal is represented by the red waveform. Basically, the output of the modulator is a series of bit stream of 1s and 0s. It has more high states (1s) density as the ramp is nearing the peak value and has increased 0s density at the low input value.

On another testing, Fig. 16 shows the output of the Sigma-Delta Modulator with a sine wave as the input. The output is a pulse-density modulated signal represented by the blue waveform and the input signal is represented by the red waveform. Similar to the observation in Figure 14, the output of the modulator is a series of bit stream of 1s and 0s with high 1s density as the input is nearing the peak value and has a high 0s density at the low input value.

Fig. 17, shows eight output waveforms of the counter. The outputs were taken from the Q terminal of DFF. VQ8 being the most significant bit while VQ1 being the least to check if the actual simulation is the same or close to the theoretical value. Equation 5 shows how to get the exact input for the whole temperature sensing circuit to give a specific digital output.

TABLE II
RESULTS OF LINE REGULATION SIMULATIONS

MOS	Post layout (linereg)				
	TT	FF	FS	SF	SS
VREF @ 2.5V (V)	0.945	0.888	0.917	0.973	1
VREFmax (V)	0.956	0.901	0.929	0.984	1.01
VREFmin (V)	0.943	0.887	0.916	0.971	0.996
Linereg (2.4V - 4.12V) (mV/V)	7.55814	8.13953	7.55814	7.55814	8.13953

TABLE III
RESULTS OF TEMPERATURE COEFFICIENT SIMULATIONS

MOS	Post layout (TempCo)				
	TT	FF	FS	SF	SS
VREF @ 27°C (V)	0.945	0.888	0.917	0.973	1.004
VREFmax (V)	0.945	0.888	0.917	0.973	1.006
VREFmin (V)	0.943	0.883	0.915	0.971	1.001
Linereg (0° - 85°) (mV/V)	24.8988	66.2427	25.6591	24.1823	58.5892

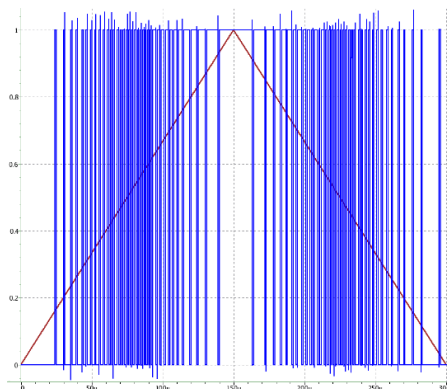

Fig. 15. Graph of sigma-delta modulator ramp as input.

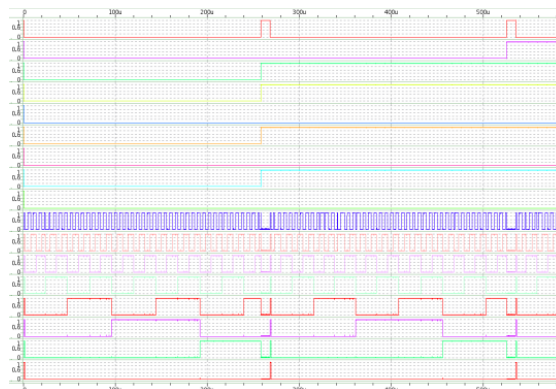

Fig. 17. 8-bit counter output.

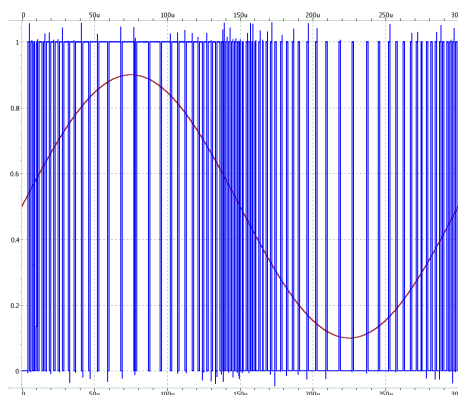

Fig. 16. Output of sigma-delta modulator sine wave as input.

$$\text{Input}_{\text{Volts}} = \left(\frac{1}{256} \right) \text{Theoretical}_{\text{binary}} \quad (5)$$

The conversion time is 256 us after which the internal reset circuitry will send a reset pulse to begin a new conversion.

The final circuit was evaluated under temperature (0°C to +85°C), power supply voltage ($V_{DD} = 2.5V$ for bandgap, $V_{DD} = 1.0V$ for the rest of the design) and process corners (TT, SF, FS, SS, FF). Shown in Table 1 is the summary of results when simulating the whole design with respect to varying temperature.

C. Incremental Sigma-Delta ADC Characteristics

1) *Linearity Testing*: Linearity testing is done to see how accurate the conversion of the circuit. Integral non-linearity (INL) is difference between the ideal resolution characteristic and the actual

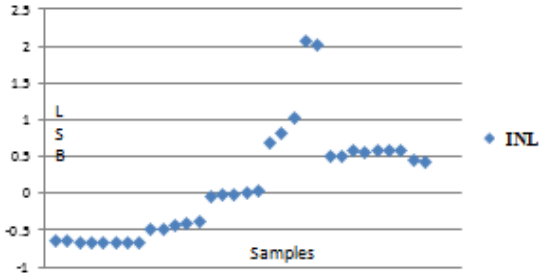

Fig. 18. INL results.

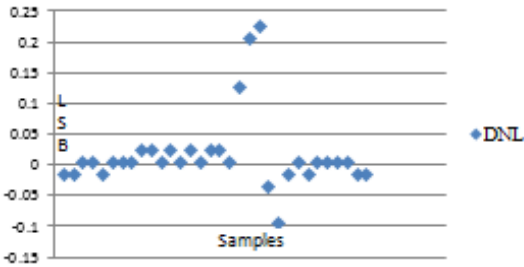

Fig. 19. DNL results.

resolution characteristic from a straight line. It can be expressed in terms of Least Significant Bit (LSB) [7]. INL can be computed using the method presented in [7-9] using Code Boundaries (CB) or the voltage threshold that causes a change in the output code.

$$\text{INL}[i] = \frac{1}{\text{DeviceLSB}} (\text{CB}[i] - \text{CB}[1] - \text{DeviceLSB} \times (i - 1)) \quad (6)$$

According to [8], device LSB step is calculated by dividing the total span of the ADC by the number of corresponding analog input transition steps or code transitions.

$$\text{DeviceLSB} = \frac{\text{CB}[2^n - 1] - \text{CB}[1]}{2^n - 2} \quad (7)$$

Fig. 18 shows the INL graph showing +2.062722048 LSB as the maximum INL.

Differential non-linearity (DNL) on the other hand is the measure of the separation between two successive output codes. Ideal separation is 1 LSB. Like the INL, it is usually expressed in LSB [7-9].

$$\text{DNL}[i] = \left(\frac{\text{CB}[i + 1] - \text{CB}[i]}{\text{DeviceLSB}} - 1 \right) \quad (8)$$

TABLE IV
RESULTS OF INL TESTING

Digital Output	INL
1	-0.638588416
2	-0.654745344
3	-0.670902528
8	-0.671373824
9	-0.667452416
10	-0.683609344
11	-0.679687936
12	-0.675766528
36	-0.501339136
37	-0.477339392
40	-0.42541824
41	-0.42149683
42	-0.397497088
64	-0.050206464
65	-0.026206464
66	-0.022285056
67	0.001714688
68	0.025714432
130	0.690488832
131	0.814880768
132	1.01958656
142	2.062722048
143	2.026486528
176	0.50946176
177	0.493304832
215	0.582083072
216	0.565926144
217	0.569847552
218	0.57376896
219	0.577690368
252	0.446077184
253	0.42992

The proponents used a sampling code characterization from 256 codes and have used an increment of LSB/50 per simulation in order to get an acceptable code boundary. Table 5 shows the INL output at different Digital Output. Table 5 shows the DNL output at different digital output.

The graph of DNL results is shown in Fig. 19. Maximum DNL is at +0.224784128 LSB.

2) *Offset Error*: This characteristic is basically defined as the measured and observed error until the first transition of the output occurs [7-9].

TABLE V
RESULTS OF DNL TESTING

Digital Output	DNL
1	-0.016156928
2	-0.016157184
3	0.003921408
8	0.003921408
9	-0.016156928
10	0.003921408
11	0.003921408
12	0.003921408
36	0.023999744
37	0.024
40	0.003921408
41	0.023999744
42	0.003921408
64	0.024
65	0.003921408
66	0.023999744
67	0.023999744
68	0.003921408
130	0.124391936
131	0.204705792
132	0.224784128
142	-0.03623552
143	-0.096470784
176	-0.016156928
177	0.003921408
215	-0.01615928
216	0.003921408
217	0.003921408
218	0.003921408
219	0.003921408
252	-0.016157184
253	-0.016156928

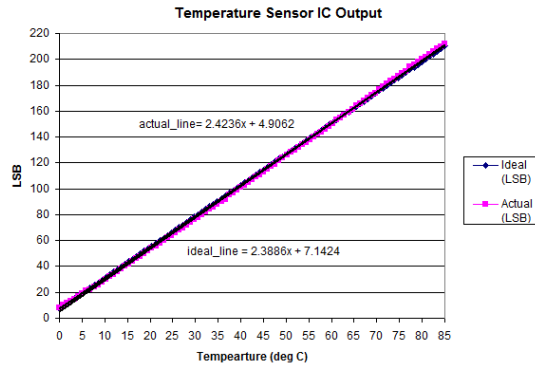

Fig. 20. Graph of the temperature sensor response.

$$\text{Gain Error} = \left[\frac{\text{CB}[2^n - 1] - \text{CB}[1]}{\text{FSR} \times \left(\frac{2^n - 2}{2^n}\right)} \right] - 1$$

$$\text{Gain Error} = \left[\frac{0.99757 - 0.00141}{1 \times \left(\frac{256 - 2}{256}\right)} \right] - 1 \quad (10)$$

$$\text{Gain Error} = 0.147089033\% \text{ FSR}$$

$$\text{Gain Error} = 1.470890331 \text{ mV}$$

$$\text{Gain Error} = 0.376547924 \text{ LSB}$$

4) *Full-Scale Error (FSE)*: This characteristic is basically the difference between the actual and ideal analog full-scale transition value. Since gain error and offset error values were already obtained, full-scale error can be expressed as the sum of offset and gain error [7-9].

$$\text{Offset Error} = \text{CB}[1] - \left[0.5 \left(\frac{1}{2^n} \right) \right]$$

$$n = 8$$

$$\text{CB}[1] = 0.001411764 \quad (9)$$

$$\text{Offset Error} = \frac{0.001411764 - \left[0.5 \left(\frac{1}{256} \right) \right]}{\frac{1}{256}}$$

$$\text{Offset Error} = -0.138588416 \text{ LSB}$$

3) *Gain Error*: This characteristic can be obtained through the highest digital code as the basis. Computing for the horizontal difference between the actual resolution characteristic and the ideal resolution characteristic at the highest digital code in terms of LSB [7-9]:

$$\text{FSE} = \text{Offset Error} + \text{Gain Error}$$

$$\text{FSE} = |-0.138588416 \text{ LSB}| + 0.376547924 \text{ LSB} \quad (11)$$

$$\text{FSE} = 0.51513634 \text{ LSB}$$

D. *Temperature Sensor IC Output*

Fig. 20 shows the graph of Temperature Sensor IC output tested within 0 to 85°C. One hundred points have been plotted with an interval of 0.85°C. It can be seen that the actual is very close to the ideal with accuracy within ±2.5 LSB which is equivalent to ±1°C.

Table 6 shows 21 points from the 100-point sample of Figure 20 to show the details of the

TABLE VI
RESULTS SUMMARY

Ideal vs Actual Output in Varying Temperature			
Temp (°C)	Voltage (V)	Ideal (LSB)	Actual (LSB)
0	0.0279	7.1424	8
4.25	0.067555	17.29408	17
8.5	0.10721	27.44576	26
12.75	0.146865	37.59744	36
17	0.18652	47.74912	46
21.25	0.226175	57.9008	56
25.5	0.26583	68.05248	66
29.75	0.305485	78.20416	76
34	0.34514	88.35584	86
38.25	0.384795	98.50752	97
42.5	0.42445	108.6592	107
46.75	0.464105	118.8109	117
51	0.50376	128.9626	128
55.25	0.543415	139.1142	138
59.5	0.58307	149.2659	148
63.75	0.622725	159.4176	159
68	0.66238	169.5693	170
72.25	0.702035	179.721	181
76.5	0.74169	189.8726	191
80.75	0.781345	200.0243	202
85	0.821	210.176	212

output. The minimum and maximum voltage of the conditioning circuit corresponds to 0°C and 85°C respectively. Since the response is linear, the increment of voltage is 7.931mV while 0.85°C for temperature in 100-point sampling. The ideal output in the table is equivalent to the voltage multiplied by 28 or 256. The actual output is read from the 8-bit PIPO register. The circuit design can operate from 0°C to 85°C with a temperature coefficient of 0.933mV/°C or 2.5LSB/°C

The design has a layout dimension of 216.98µm x 197.71µm without bonding pads. Fig. 21 shows the Integrated Circuit (IC) layout with its corresponding floor plan. The output file of the simulation shows that the average power consumed is 1.3147mW while the maximum peak power consumed is 3.2338mW.

IV. CONCLUSION

In this study, a CMOS Based Temperature Sensing IC with a low voltage Incremental Delta-Sigma ADC has been designed and presented. The Temperature Sensing Circuit operates at 2.5V while the Incremental Delta-Sigma ADC operates at 1V. The whole design was implemented using 0.18µm CMOS technology using Synopsys tools. A bandgap reference

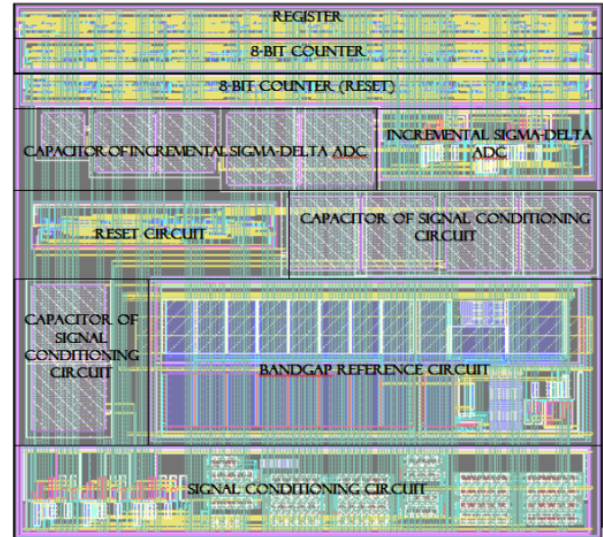

Fig. 21. Layout of the temperature sensing circuit.

circuit has been successfully designed with a stable V_{ref} of around 0.945 Volt from 2.4V to 4.14V with respect to temperature ranging from 0°C to 85 °C. The PTAT section of the bandgap reference has been utilized as the temperature sensor. A signal conditioning circuit has been designed and incorporated to the PTAT of the bandgap to produce a signal acceptable to the input range of the ADC. The PTAT output with signal conditioning circuit has a linear output ranging from 27.9mV to 821mV from 0°C to 85°C. Internal Reset Circuit and 8 bit register has been designed and implemented. Testing of 100 samples from 0°C to 85°C, the whole design passed the ADC linearity in all process corners. ADC characterization obtained satisfactory results. The actual output is read from the 8-bit PIPO register. The circuit design can operate from 0C to 85°C with a temperature coefficient of 0.933mV/°C or 2.5LSB/°C

For future work, a 2x1 multiplexer circuit can be inserted between the output of the signal conditioning circuit and the input of the ADC which enables the user of the IC to select where the analog input signal would come from giving flexibility to the use of the ADC for other input signal.

ACKNOWLEDGMENT

The authors would like to thank De La Salle University (DLSU) Manila and Department of Science

and Technology Engineering Research and Development for Technology (DOST-ERDT) for funding this project.

REFERENCES

- [1] Microstar Laboratories, "Temperature measurement using data acquisition processors," Retrieved 2013-09-17. [Online]. Available: <http://www.mstarlabs.com/sensors/temperature.html>
- [2] Y.-S. Lin, D. Sylvester, and D. Blaauw, "An ultra low power 1V, 220nW temperature sensor for passive wireless applications," in *Custom Integrated Circuits Conference, 2008. CICC 2008. IEEE*. IEEE, 2008, pp. 507–510.
- [3] D. A. David, "Design and characterization of a 0.25Um all-MOS sub-1V bandgap voltage reference," Master's thesis, De La Salle University, 2401 Taft Ave., Manila 0922, Philippines, 2013.
- [4] J. P. C. Cajueiro and C. A. D. R. Filho, "Tracking-vgs: A temperature compensation technique to implement all-MOS reference voltages," in *Devices, Circuits and Systems, Proceedings of the 6th International Caribbean Conference On*, Apr. 2006, pp. 287–291.
- [5] A. Chamakura, "Iddq testing of a CMOS first order sigma-delta modulator of an 8-bit oversampling ADC," Master's thesis, Louisiana State University, Baton Rouge, Louisiana 70803, USA, Aug. 2004.
- [6] A. C. Abad, "A 0.35Um low voltage ADC using sigma delta modulator with CIC decimator filter," Master's thesis, De La Salle University, 2401 Taft Ave., Manila 0922, Philippines, 2011.
- [7] R. Gorospe, J. Javier, and A. Nicolas, "Design of CMOS based incremental sigma-delta analog-to-digital converter," Bachelor's thesis, De La Salle University, 2401 Taft Ave., Manila 0922, Philippines, 2010.
- [8] M. Baker, *Demystifying Mixed Signal Test Methods*. Burlington, MA, USA: Elsevier, 2003.

Implementation of a Vertical Take-off and Landing for DC Motor-based Rotorcraft

Elmer Magsino, Mark Lorenze Torregoza, and Elmer Dadios

Abstract—This paper uses Matlab/Simulink to demonstrate the vertical take-off and landing control of a rotorcraft, which is assumed to have DC motors instead of the conventional BLDC motors. The rotorcraft system is modeled by its DC motors instead of its nonlinear dynamic model. A PI controller compensates the DC to achieve its desired motor speed. The DC shunt motors are supplied by a 12VDC battery chopped by a 2-quadrant chopper, and have maximum rated speeds of 50000rpm. At this speed, the theoretical reachable maximum height is 10m when the rotorcraft has no load.

Unlike most models, the load disturbance is not equally shared by the DC motors. Instead, each motor carries the actual weight. A fuzzy logic controller is used to determine the necessary individual motor speed to attain the vertical take-off height. During various simulation experiments of four-rotor rotorcraft, the desired altitude load disturbance are introduced to verify system response.

It has been verified that the proposed fuzzy-classical control of DC motors implementing a vertical take-off and landing allows ease in controlling the vertical flight and avoiding too much nonlinearities in the rotorcraft system.

Index Terms—rotorcraft, vertical take-off and landing, fuzzy logic control.

I. INTRODUCTION

UNMANNED aerial vehicles (UAVs) or flying drones are becoming increasingly common [1] but are one of the most complex flying machines because of its capabilities to perform various maneuvers [2]. Aside from being used in leisure, more scientific and research studies have incorporated rotor-

crafts in the fields of traffic surveillance, air pollution monitoring, area mapping, and remote applications [3]. A rotorcraft is a flying vehicle that has rotating blades to achieve flight. Most common rotorcrafts have four, six, and eight motors. One of these UAVs which have gained tremendous research attention is the quadrotor which is shown in Fig. 1 below.

Figure 1 illustrates the coordinate assignments of quadrotor in the “+” orientation, that is, one of its motor arms is aligned in the x-axis, their thrust vectors, and directions of rotation. The body-fixed frame B is located at the vehicle’s center of mass and also serves as its origin. When looking from the top, rotors 1 and 3 rotate counterclockwise while rotors 2 and 4 rotate clockwise. The rotor speed is denoted by ω_i and the thrust is an upward vector equal to:

$$T_i = b\omega_i^2, i = 1, 2, 3, 4 \quad (1)$$

in the vehicles negative z-direction, where $b > 0$ is the lift constant. This variable b depends on the number of blades and its chord length, air density, and the cube of the rotor blade radius. [1]. The derivation of the simplified model of this UAV is also shown in [1].

In [4], a hybrid control based on discrete automaton and classical PID controllers were introduced. This was proposed based on the systems propulsion nonlinearities and underactuated nature. Rotorcraft modeling have been presented in [5], [6] for quadrotors, [7], [8] for hexacopters and [9], [10] for octorotors/octocopters. The nonlinear models were presented using both the kinematic and dynamic aspects of the rotorcraft. Various control methods such as visual feedback, classical control, and nonlinear control such as sliding mode and fuzzy logic were also discussed to allow the respective rotorcraft

E. Magsino and M. L. Torregoza are with the Electronics and Communications Engineering Department, De La Salle University, Manila, Philippines.

E. Dadios is with the Manufacturing Engineering and Management Department, De La Salle University, Manila, Philippines.

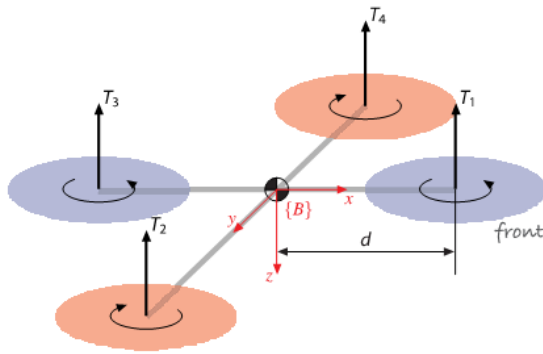

Fig. 1. Quadrotor model [1].

a stable flight simulations and actual experiments were used to verify their proposed control algorithm.

In this research, achieving vertical take-off and landing flight stability relies on properly modeling and classically controlling the DC motors. The non-linear fuzzy logic controller is used to provide what motor speeds are needed to attain the desired altitude given a load disturbance in the motor arms. In short, controlling the DC motors appropriately allows the stable vertical take-off and landing flight of the rotorcraft. Ideally, if the motors are presented with an equal amount of load distribution, then there should be equal thrusts to be exerted by each motor to achieve vertical flight stability. The speed of the DC motors are compensated by a classical PI controller while the input to each motor is decided by a fuzzy logic controller.

The main idea proposed adequately models and controls a shunt DC motor instead of brushless DC motors (BLDC). Conventional DC motors have many attractive properties such as high efficiency and linear torque-speed characteristics. Also, the control of DC motors is also simple and does not require complex hardware [11]. Differential equations and Laplace Transforms were used to model the Shunt DC motor.

Fuzzy logic control is used to determine the appropriate speed needed by each motor to achieve a certain desired height. This control scheme will take into consideration the desired height and the load disturbance distributed over the DC motors.

Section II discusses the complete shunt DC motor model and classical compensation and fuzzy control. On the other hand, Section III shows the results and

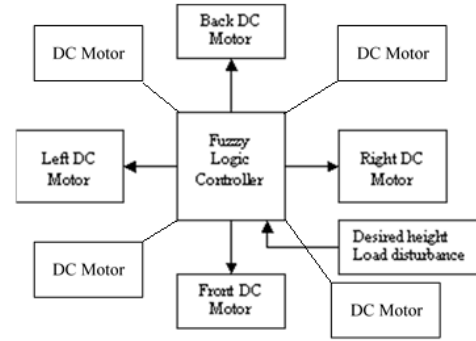

Fig. 2. Rotorcraft system model.

discussions of the response of the proposed system under varying load conditions, that is, speed, load torque and desired height attainment. Finally a brief conclusion and future directives of this research work is provided.

II. DEVELOPMENT OF THE VERTICAL TAKE-OFF AND LANDING QUADROTOR SYSTEM

The Vertical Take-off and landing rotorcraft system is shown in Fig. 2. The limit of the number of motors will depend on the hardware controller to be used.

The following are the assumptions made in this research work:

- 1) Identical DC motors from the same manufacturer are to be used. The maximum speed of the DC motor is set to 50000rpm and can reach a height of up to 10 meters.
- 2) The rotorcraft to be used has a rigid body and the components are placed symmetrical with respect to the center. Its center of gravity is located at the intersection of the beams holding the DC motors.
- 3) Wind disturbance or forces affecting the x- and y-axes are not considered.
- 4) Load disturbance is applied only in the negative z-axis direction and directly applied to the DC motors. Maximum load disturbance for each motor is 0.03Nm.

The DC motor and two-quadrant chopper models follow that of what are given in [12]. Table I shows the DC motor characteristics. These values are for the no-load speed of 50000rpm.

TABLE I
DC MOTOR CHARACTERISTICS

Moment of Inertia (J)	5.223×10^{-7} kg-m ²
Motor Viscous Friction Constant (B)	0.90×10^{-5} N-m-s
Electromotive Force Constant (K_v)	3.55×10^{-4} V/rad/sec
Electric Resistance (R)	0.0790 Ω
Electric Inductance (L)	0.77×10^{-5} Henry

Fig. 3 shows the MATLAB/Simulink model of the compensated two-quadrant DC motor. A sample response of the DC motor is shown in Fig. 4. The desired input speed is -100 rpm. The negative sign denotes a clockwise direction.

The controller used to regulate the speed and torque of the motors are Proportional-Integral (PI). Classical compensation is carried out through the use of Matlabs SISO Toolbox.

A. Quadrotor Platform - Sample Model

We consider a quadrotor platform model in verifying the proposed methodology. This developed model using Matlab/Simulink is shown in Fig. 5. The DC Motor block xxx , where xxx is either Left, Right, Front, or Back, contains the DC motor model in Fig. 3.

The “Speed” subsystem accepts the desired angular speed of the DC motor that will achieve the desired height. The “Load” subsystem accepts the allowable load that each motor can carry prior without losing speed regulation.

B. Fuzzy Logic Controller

The fuzzy logic controller uses a Mamdani type to achieve the desired vertical take-off height, given a certain load disturbance on each of the motor. Since the quadrotor is a nonlinear and under-actuated system, the use of such controller can eliminate certain dynamic aspects which were not considered during the modeling of the DC motor that can affect the quadrotor vertical take-off and landing capabilities.

The corresponding membership functions (MFs) for the inputs to fuzzy logic controller are shown in Fig. 6. The inputs to the fuzzy logic controller are

TABLE II
FUZZY RULE BASE

Load Disturbance	Height					
	VL	L	OK	H	VH	VVH
VLi	VS	S	OK	F	VF	VVF
Li	S	S	OK	F	VF	VVF
OK	OK	OK	OK	F	VF	VVF
He	F	F	F	F	VF	VVF
VHe	VF	VF	VF	VF	VF	VVF
VVHe	VVF	VVF	VVF	VVF	VVF	VVF

height and load disturbance. For height, the values are from 0–10 meters and have three classifications, namely: (1) very low (VL), (2) low (L), (3) ok, (4) high (H), (5) very high (VH), and (6) very very high (VVH). The low and very very high have open ended trapezoidal membership functions while the rest have closed trapezoidal membership functions.

The other input to the fuzzy logic controller is the load. The classifications are (1) very light (VLi), (2) light (Li), (3) Ok, (4) heavy (He), (5) very heavy (VHe), and (6) very very heavy (VVHe). These are used to determine the intensity of the load disturbance from 0 0.03Nm. Linear membership functions were used because they are simple to implement and fast to compute.

The output membership functions are shown in Fig. 7. The output MFs are delta functions modeled by triangular membership functions with narrow bases. The motor speeds are categorized to (1) very slow (VS), (2) slow (S), (3) OK, (4) fast (F), (5) very fast (VF), and (6) very very fast (VVF).

The *min* operator is used for the implication method of the fuzzy logic controller, while the *max* operator implements the aggregation of each rule output. Finally, finding the centroid of the aggregated output constitutes the defuzzification stage.

Table II shows the fuzzy rule base to determine the necessary DC motor speed given the desired altitude and load disturbance. The fuzzy rule is governed by:

<pre>if (Height AND Load Disturbance) then Motor Speed</pre>
--

The load disturbance produces a downward force, thus decreasing the upward movement provided by the thrust due to the motor speed.

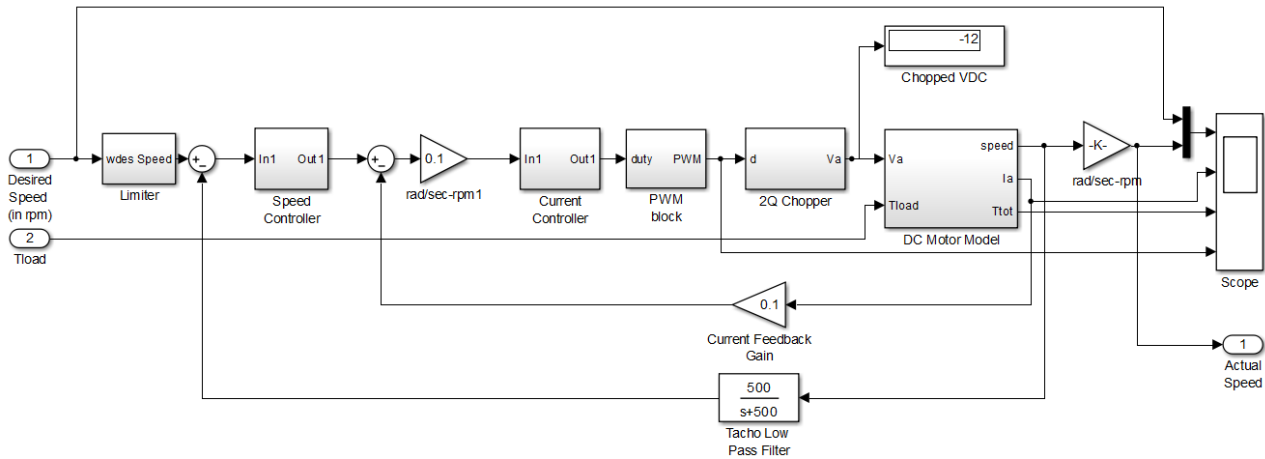

Fig. 3. DC motor MATLAB/Simulink model.

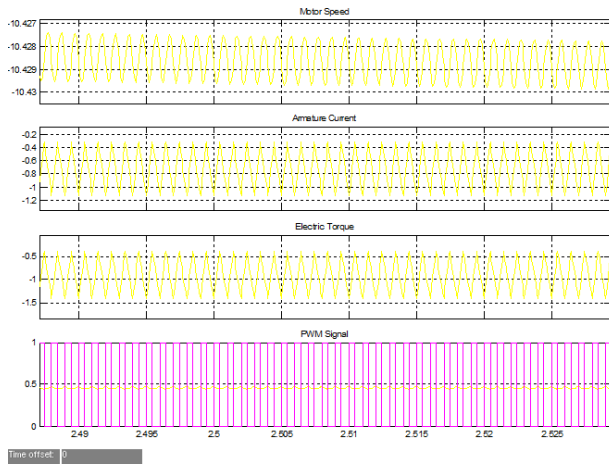

Fig. 4. Motor response at desired speed of -100 RPM [13].

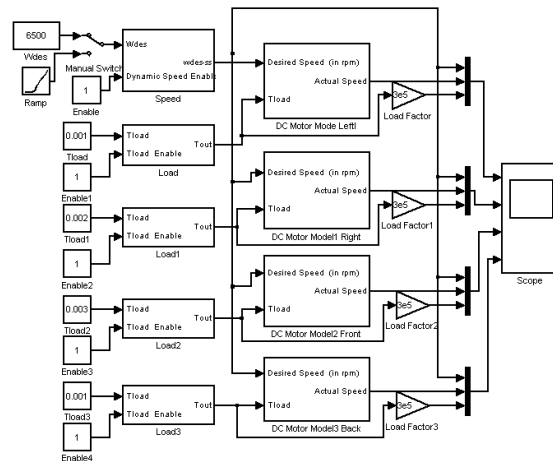

Fig. 5. Simulink model of a quadrotor platform.

Fig. 8 shows the total response of the fuzzy logic controller for any combination of the inputs height and load disturbance. There is a linear response on how the DC motor angular speed will change.

C. Fuzzy Logic Controlled Quadrotor Platform

Fig. 9 shows the whole Simulink model of the Vertical Take-off and Landing system of the quadrotor platform. The dashed box highlights the desired input to be achieved. The possible desired altitude commands are: (1) constant height, (2) ramp with a positive slope to depict a continuously increasing height, (3) triangular waveform to represent the vertical take-off and landing, and (4) step input to portray a sudden change in the desired height.

The load disturbance input section is emphasized by the finer dashed box. Each motor will be subjected to a certain load disturbance. In practice, these load disturbances are averaged and located at the center of mass of the rotorcraft. A dynamic loading is also introduced to the system. This may represent a sudden shift in the payload of the rotorcraft platform. If the enable constant is “1”, then there is dynamic loading being introduced to the DC motors. The dynamic loading is modeled by a rectangular waveform.

In the fuzzy logic controller subsystem, the enable constant allows the dynamic loading of the desired speed to be inputted to the motors, though this may

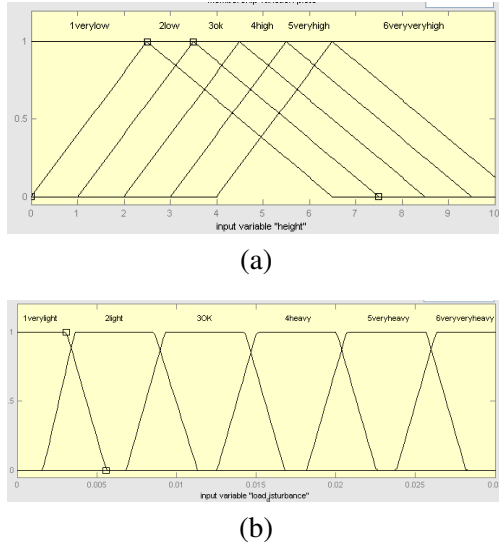

Fig. 6. Input membership functions. (a) Quadrotor altitude and (b) load disturbance.

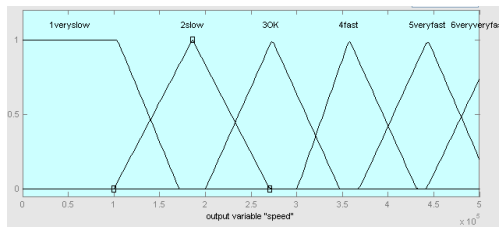

Fig. 7. Output membership functions for DC motor speed.

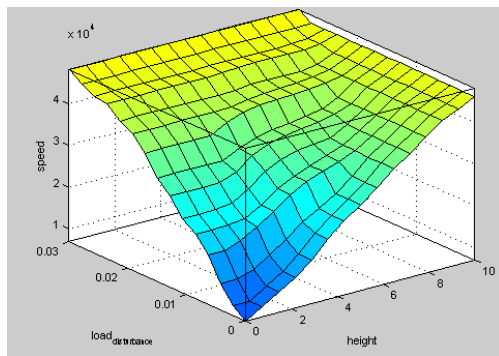

Fig. 8. Surface view of the fuzzy rule base.

be also achieved by placing a dynamic speed loading in the input of the fuzzy logic controller.

III. SIMULATION RESULTS AND DISCUSSION

There are two steps made when simulating the proposed methodology on a quadrotor platform. The processes involved are given below.

1) *DC Motor model simulation.* The DC motor model was verified under various conditions including speed and loading. The variations among the input conditions are:

- constant speed and load disturbance;
- varying speed and constant load disturbance;
- constant speed and varying load disturbance and
- varying speed and load disturbance.

2) *System Integration.* The fuzzy controller and classically compensated DC Motors are combined into one system and subjected to any static and dynamic combinations of height and load disturbance inputs.

A one-second soft start is always implemented to ensure that the current intake and speed of each motor do not instantaneously change. To clearly visualize a single simulation run, the load disturbance figure is superimposed and is multiplied by a certain factor that will allow it to be clearly seen. Figs. 10-13 show the different simulation results for the different tests enumerated above. In Figs. 12-13, the load disturbance values are multiplied by a factor of 3×10^6 .

Subjected to different types of loading disturbance, the classically compensated DC motor is able to regulate its speed. One of the limitations experienced in the simulation is the soft start modeling and implementation. During soft start, overshoots and undershoots are noticeable when it should exhibit a linear ramping of the motor speed.

After verifying all dynamic and static tests for the classically compensated DC motors, the system shown in Fig. 9 is implemented. The inputs are now the height and the load disturbance experienced by each motor.

The height h attained by the quadrotor due to the angular speed ω produced by its motor is given by the linear relationship shown in Equation 2. This linear relationship was taken from the surface view of the fuzzy controller shown in Fig. 8.

$$h = a\omega + b \quad (2)$$

The coefficients a and b are determined by using the Curve Fitting Toolbox of Matlab. Using the data obtained from a ramping height function from 0-10

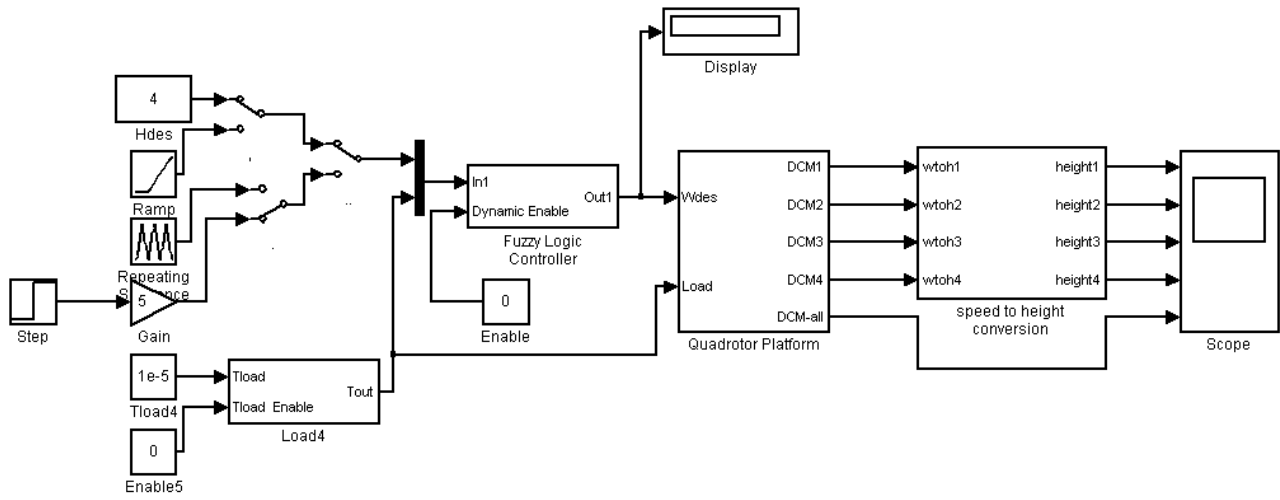

Fig. 9. Simulink model of the fuzzy logic control of four DC motors of a quadrotor platform.

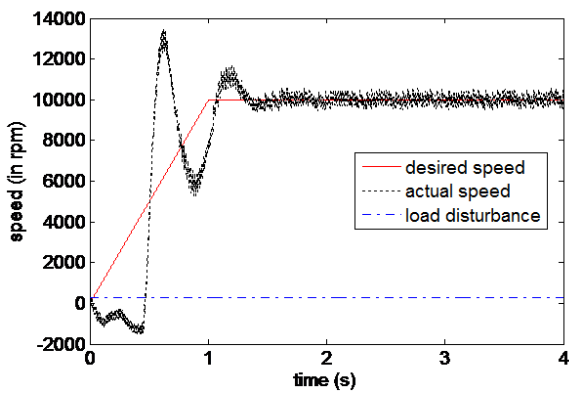

Fig. 10. Constant speed and load disturbance.

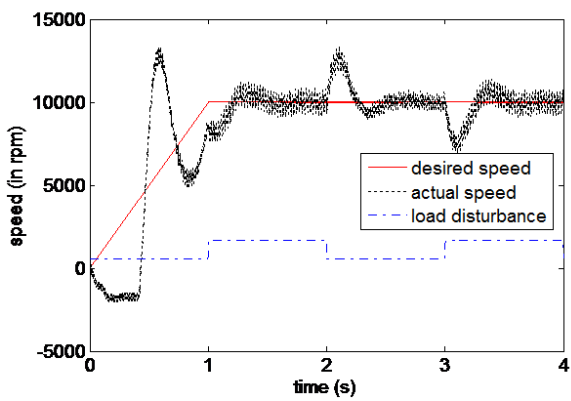

Fig. 12. Constant speed and varying load disturbance.

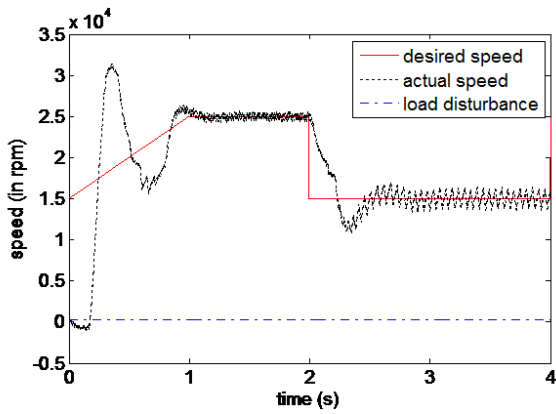

Fig. 11. Varying speed and constant load disturbance.

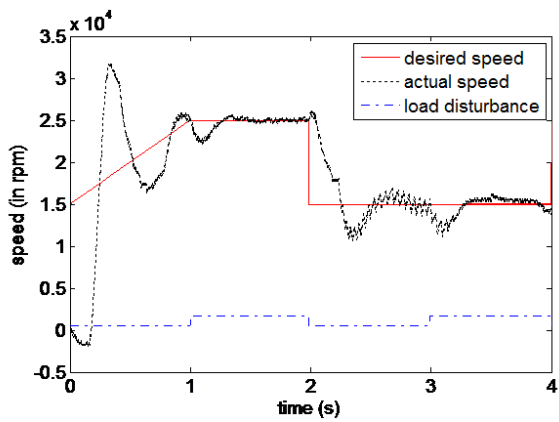

Fig. 13. Varying speed and load disturbance.

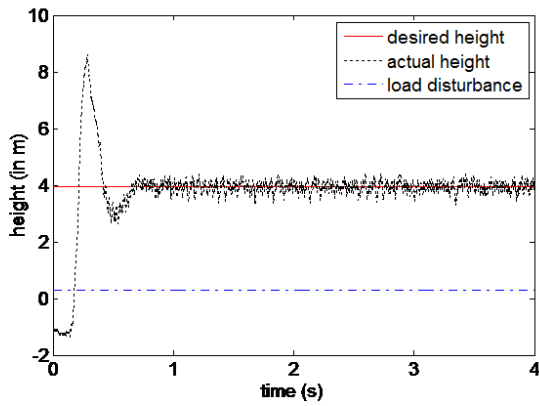

Fig. 14. Abrupt take-off with constant load.

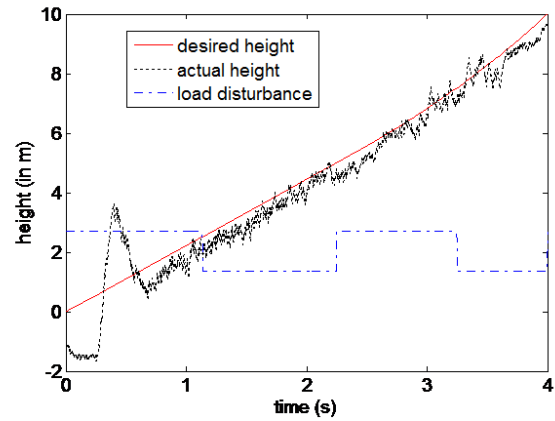

Fig. 17. Smooth take-off with varying load.

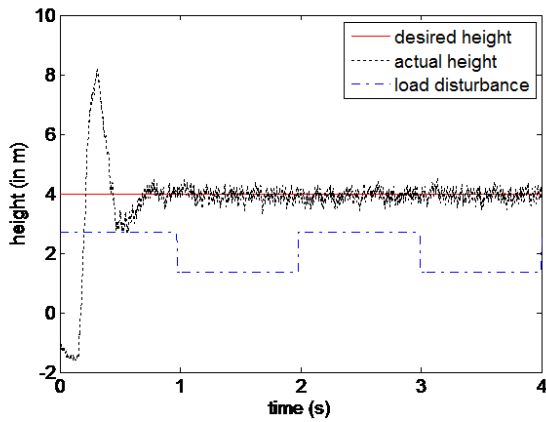

Fig. 15. Abrupt take-off with varying load.

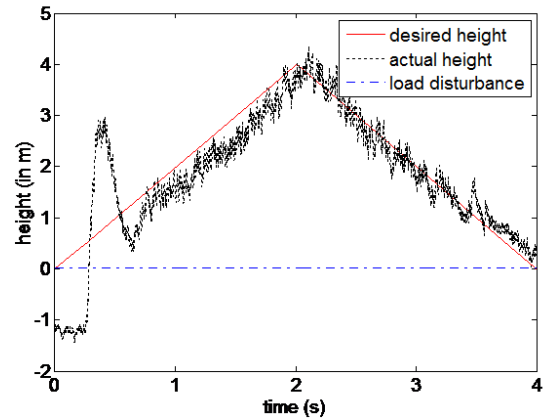

Fig. 18. Smooth take-off and landing with constant load.

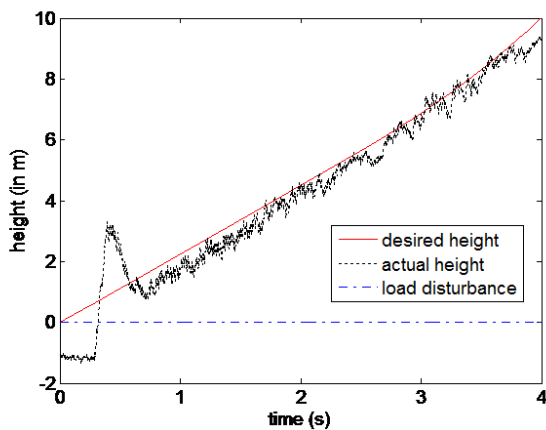

Fig. 16. Smooth take-off with constant load.

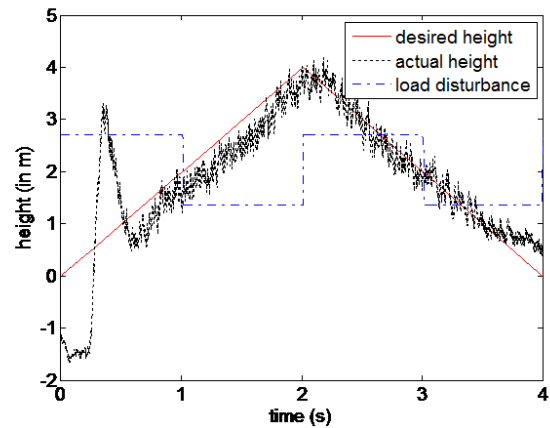

Fig. 19. Smooth take-off and landing with varying load.

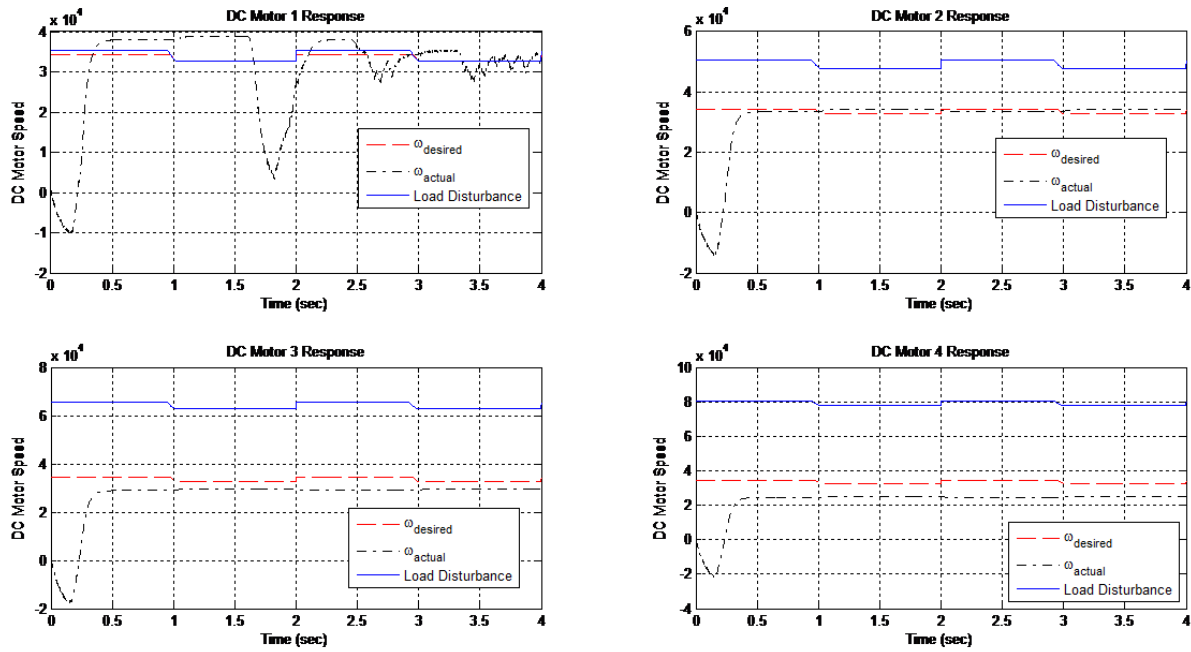

Fig. 20. Angular speed of each DC motor with variable load disturbance.

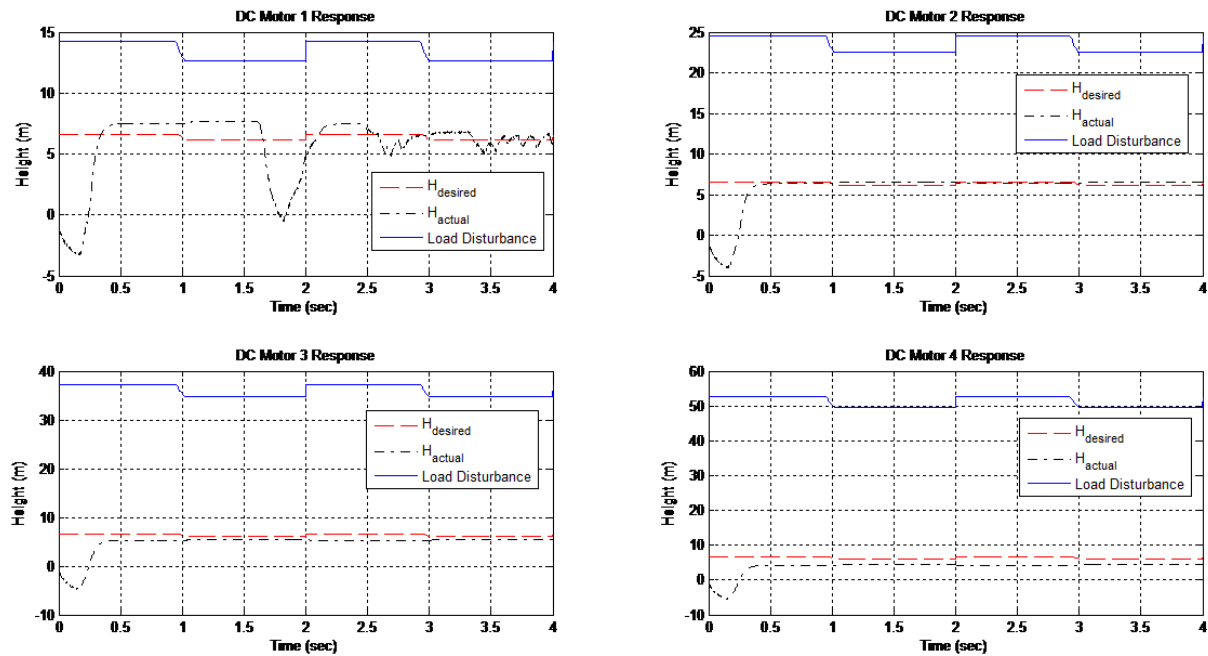

Fig. 21. Quadrotor height achieved by each DC motor with variable load disturbance.

meters with load equal to 0.0019 N-m, a and b are found to be:

$$a = 0.0002384 \frac{\text{m}}{\text{rpm}}$$

$$b = -1.409\text{m}$$

The constant b is the initial height of the quadrotor before liftoff takes place. A negative sign means that the controller is $|b|$ meters above the ground. However, from this curve-fitted answer, an actual quadrotor must be at approximately 1.4 meters high, which may depict that the quadrotor under simulation is huge to begin with, however, the discussion on the actual quadrotor to be really used is beyond the scope of this discussion.

Depending on the initial weight experienced by each motor of the quadrotor, the needed angular speed ω to produce liftoff varies, as given by Equation (1).

The fuzzy-controlled quadrotor platform system in Fig. 9 is subjected to the different simulation setups: Tests 1-3 demonstrate the different possible vertical take-off and landing scenarios and have equal distribution of loading disturbances. Test 4 has the system undergoing variable load disturbance for each DC motor.

- 1) Abrupt take-off, that is, constant height subjected to constant and varying load disturbance;
- 2) Smooth take-off, that is, 0-10 meters ramping function subjected to constant and varying load disturbance; and
- 3) Smooth vertical take-off and landing subjected to constant and varying load disturbance.
- 4) Any of the scenarios above having distinct load disturbance for each motor

The simulation results for Tests 1-3 are shown in Figs. 14-19. The overshoot propels the quadrotor to lift itself from the ground and settles to the desired 4-m height. The negative height means that the quadrotor has not yet taken off the ground. This value is approximately equal to b .

During the load disturbance dynamic loading disturbance, the fuzzy logic controller is fast enough to generate the required angular speed to counter the effects of gravity and the addition or removal of the weight on each motor.

Figs. 20-21 show the simulation results for Test 4. DC motor 4 experiences the heaviest load among all DC motors and as a result, it rotates at a faster angular speed compared to the other three to achieve the desired height.

IV. CONCLUSION

The proposed fuzzy-classical approach to the vertical take-off and landing of a quadrotor system through simple modeling and control of its DC motors has shown promising results in making a quadrotor reach a specified desired height during vertical take-off and landing.

Simulation experiments have verified that given a desired height and load disturbance, whether static or dynamic in test procedures, the rotorcraft system was able to reach the required height. The mathematical model of the DC motor was easily developed in MATLAB/Simulink.

However, an attitude control must be added to address the different loading effects experienced by each DC motor. Also, in future works, the vertical take-off and landing will include motions in the x - and y -axes. The rotorcraft platform must be built in order to empirically verify the performance of the proposed system.

REFERENCES

- [1] P. Corke, *Robotics, Vision and Control: Fundamental Algorithms in MATLAB®*. Berlin, Heidelberg: Springer Berlin Heidelberg, 2011.
- [2] P. Castillo, A. Dzul, and R. Lozano, "Real-time stabilization and tracking of a four-rotor mini rotorcraft," *Control Systems Technology, IEEE Transactions On*, vol. 12, no. 4, pp. 510–516, 2004.
- [3] P. Castillo, R. Lozano, and A. Dzul, "Stabilization of a mini rotorcraft with four rotors," *IEEE Control Systems Magazine*, vol. 25, no. 6, pp. 45–55, 2005.
- [4] M. Orsag and S. Bogdan, "Hybrid control of quadrotor," in *Control and Automation, 2009. MED'09. 17th Mediterranean Conference On*. IEEE, 2009, pp. 1239–1244.
- [5] A. L. Salih, M. Moghavvemi, H. A. Mohamed, and K. S. Gaeid, "Modelling and PID controller design for a quadrotor unmanned air vehicle," in *Automation Quality and Testing Robotics (AQTR), 2010 IEEE International Conference On*, vol. 1. IEEE, 2010, pp. 1–5.
- [6] S. Khatoun, D. Gupta, and L. Das, "PID & LQR control for a quadrotor: Modeling and simulation," in *Advances in Computing, Communications and Informatics (ICACCI), 2014 International Conference On*. IEEE, 2014, pp. 796–802.

- [7] G. Du, Q. Quan, and K.-Y. Cai, "Additive-state-decomposition-based dynamic inversion stabilized control of a hexacopter subject to unknown propeller damages," in *Control Conference (CCC), 2013 32nd Chinese*. IEEE, 2013, pp. 6231–6236.
- [8] S. Busarakum and V. Srichatrapimuk, "The design of sliding mode control of a hexarotor," in *Systems, Process and Control (ICSPC), 2014 IEEE Conference On*. IEEE, 2014, pp. 47–52.
- [9] H. Alwi and C. Edwards, "Sliding mode fault-tolerant control of an octorotor using linear parameter varying-based schemes," *Control Theory & Applications, IET*, vol. 9, no. 4, pp. 618–636, 2015.
- [10] M. Saied, H. Shraim, C. Francis, I. Fantoni, and B. Lussier, "Actuator fault diagnosis in an octorotor UAV using sliding modes technique: Theory and experimentation," in *Control Conference (ECC), 2015 European*. IEEE, 2015, pp. 1639–1644.
- [11] S. Baldursson, "Bldc motor modelling and control - a matlab/simulink implementation," 2005, Retrieved 2016-02-07. [Online]. Available: <http://matlabproject.ir/forms/files/806274.pdf>
- [12] R. Krishnan, *Electric Motor Drives: Modeling, Analysis, and Control*. Prentice Hall, 2001.
- [13] J. C. Magsino and E. R. Magsino, "Speed and torque control of a DC shunt motor," in *5th NOCEI Research Congress*, Cavite City, Cavite, 2009.

WebSurge: A Profile-based Stress Testing Tool with Distributed User Agents for Web Applications

Michael de la Cruz, Jeyran Labrador, and Dante Dinawanao

Abstract—WebSurge is a stress testing tool designed for web applications written in PHP and Erlang/OTP. It requires a third party sniffing tool to record the session of actual users while accessing a particular web-based application then translates it into a sequence of HTTP requests to form a user profile, and executes them in several instances using software agents, as if they were executed concurrently by real users. Also, the number of users to simulate requests and intervals can be configured according to your target end-user (e.g., a company with 1000 employees). Once started, WebSurge monitors resource utilization (e.g., memory, network, CPU) of the target application server at the same time, keeps track of each transaction performed inside the target application itself, like the execution of an SQL query or rendering a page. After which, the WebSurge displays the summarized performance data of the targeted web application.

In this study, two web applications were subjected to stress-test using WebSurge to test its functionality. Also, a side-by-side comparison was made with existing stress-testing tools namely, httpperf, WAPT, and Tsung, in order to benchmark the strengths and weaknesses of WebSurge over them. The conducted stress tests with WebSurge stress testing tool had proven that it was capable of pushing the test applications to its limit and was able to collect the utilization and performance data which was presented into summarized tables based on the desired performance criteria. The benchmark results proved that among the stress testing tools, WebSurge alone can provide dynamic profiles for user agents. WebSurge and Tsung were both capable of distributing the tasks that allowed them to provide large number of simultaneous HTTP user agents

while WAPT and httpperf were limited to the capacity of their host system. Consequently, httpperf, Tsung, and WAPT can control the frequency of requests while WebSurge used the configured interval of each agent and the think-time for each request.

Index Terms—stress test, software agents, web application, concurrency, distribution.

I. INTRODUCTION

NOWADAYS, web application development gains popularity due to the success of several web applications in the internet such as Google, Facebook, and Twitter [1]. As a result, there had been an increase of interest in building web based-applications among the students in software engineering classes and professional programmers. An analysis that was conducted in 2008 by Information-Age IT suggested that most web implementation failures were due to unexpected increase of request that forced them to shutdown their servers. In addition, it demonstrated that if the website was down, search engines may remove the site, partners may remove links to the site, visitors will have a negative opinion and definitely will withdraw their trust of the site, and then it will lose sales [2]. These could have been prevented if the applications had undergone stress testing before it was published to the internet.

Most of the software engineering students and web programmers use various tools to evaluate their work such as Yslow, Firebird, Google analytics, and other third party applications [3]. However, these testing tools were limited to the client-side scripts, page evaluation, and design optimizations thus; none of them were capable of evaluating the stress level and actual limitations of the web application. One

M. de la Cruz and J. Labrador are students at the Mindanao University of Science and Technology, Cagayan de Oro City, Philippines.

D. Dinawanao is with the Computer Science Department, Mindanao State University – Iligan Institute of Technology, Iligan City, Philippines.

of the best methods in measuring the limitations of a web application is through stress testing [4]. However stress testing is difficult to setup since it requires enough respondents that could push a web application to its limits. It also requires so much time and money which is difficult for students or novice web programmers to comply within the duration of their project.

A. Methodology

This chapter described the methods and technologies used in constructing the stress testing tool. It also discusses the challenges in conducting stress testing and performance evaluation on web based application.

B. System Overview

The proposed system is an integration of a performance evaluation system and a stress testing tool intended for novice web applications. It provides configurable user profile, flexible configurations, and distributable agents for a reliable stress testing of the targeted application and the web server. It was composed of three major components (Fig. 1):

- 1) *Agent Definition and Performance Evaluation Software*: This collects requests definition of the targeted application using an open source HTTP sniffing tool and translates the sniffed HTTP requests into user profiles for HTTP user agents. After stress test was conducted, the performance log files were collected and imported to this module to formulate performance reports and dashboard.
- 2) *HTTP Client (Agent)*: The HTTP agents are responsible in translating the user profiles into a series of HTTP requests and send them to the targeted application. This is done through distributed message-passing where the agent server defines the user profile (agent behavior) and number of instances, then sends it to all active workers (client agents) residing on different computers.
- 3) *Performance Logging Script*: The web application and web server performance was collected by logging scripts during the stress test. In logging the web application performance the proponent had written a logging script which

was inserted into the target applications source code to identify start and end markers in generating pages and executing queries. The web server performance requires a third party logging application collectl, which is capable of monitoring the statistical data into a tabular form.

C. Translation of User Transactions into Protocol-Specific Commands

User profiles of the targeted application were defined based on HTTP requests sniffed using an open source HTTP sniffing tool. These requests were extracted and parsed to define a configurable user profile [5]. The compiled profiles were used by the agent server and distributed to all active agent clients. The agent clients that received the profiles encoded it back into sequence of HTTP requests and sent it to the targeted application with defined simultaneous instances (Fig. 2).

D. Development of Software-Agents

The designed software agents were composed of an agent server and agent client written in Erlang OTP using the concept of pool of processes implementation [6] (Fig. 3).

The agent server compiles the received agent profile from database through the PHP-Erlang Bridge (PEB) and specifies the number of agent instances that will be executed and their interval then distributes the task to all active agent clients as described on Algorithm 1.

ALGORITHM 1. AGENT SERVER DISTRIBUTION ALGORITHM

```

START
LOOP (){
  IF (RECEIVE {Nodes, Agent_Profile, Agent_Ids});
    Active_Nodes = CHECK_NODES(Nodes);
    DISTRIBUTE_TASK (Active_Nodes, Agent_Profile, Agent_Ids);
  END IF
}

```

Agent clients were run on separate stations waiting for tasks from the agent server. As shown in Algorithm 2 after the agent server converted agent profile into sequence of HTTP requests it distributed the task to agent clients and the agent clients simultaneously sent the requests to the targeted web application with the specified number of instances

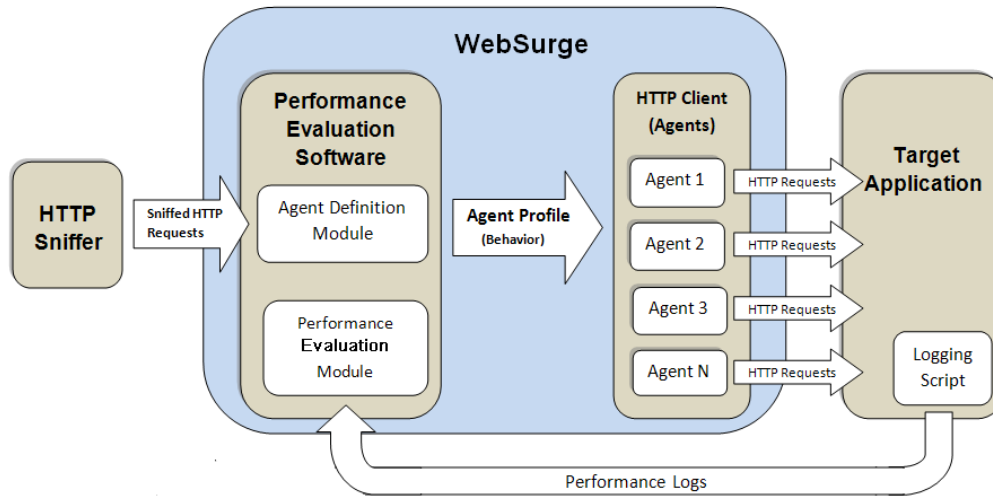

Fig. 1. WebSurge system architecture.

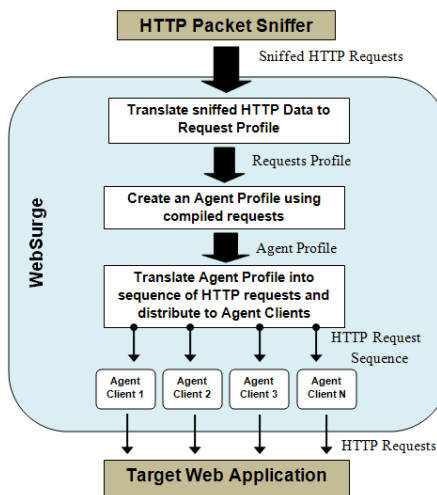

Fig. 2. HTTP Request translation diagram.

and interval. It is also designed to terminate when the targeted application failed to respond in five consecutive times.

II. DEVELOPMENT OF PERFORMANCE EVALUATION SOFTWARE

The Performance evaluation software was designed to provide a comprehensive summarized performance reports of the targeted application and web server after the stress test was executed. The performance evaluation reports were displayed in an organized dashboard using the desired criteria shown

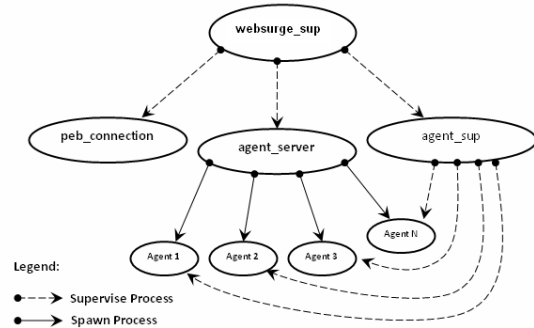

Fig. 3. Process control diagram (OTP pool of processes).

ALGORITHM 2. HTTP CLIENT REQUEST ALGORITHM

```

WHILE( True )
BEGIN
  IF (RECEIVE {Agent_Profile , Start_Id , End_Id });
  SPAWN EXECUTE ( Agent_Profile , Start_Id , End_Id );
  END IF
EXECUTE ( Agent_Profile , Start_Id , End_Id ){
  WHILE ( Start_Id <= End_Id )
  SPAWN SEND_TO_TARGET( Agent_Profile , Start_Id );
  Start_Id ++;
  END WHILE
}
SEND_TO_TARGET( Agent_Profile , Id ){
  Raw_Requests = APPLY_DATA_RULES ( Agent_Profile , Id );
  FOREACH Raw_Requests AS Request
  SEND_REQUEST Request;
  END FOREACH
}
END
}
    
```

Table I which was based on the Performance Testing Guidance for Web Applications [7].

Data presented in the dashboard was based on

TABLE I
PERFORMANCE EVALUATION CRITERIA

Performance metrics	Category
Processor	Processor utilization
Process	Memory consumption Processor utilization Process recyles
Memory	Memory available Memory utilization
Network	Network utilization
Response times	Transactions times

the performance logs collected during the stress test. The performance evaluation software was written in PHP, Javascript, and CSS and was cautiously designed to demonstrate the performance of the web application adjacent to the increasing number of simultaneous requests and portrayed the trend of server load specifically on the processor, memory, and network during the stress test.

III. RESULTS AND DISCUSSIONS

Statistical data was gathered after the conducted stress test with two different web applications to validate and verify the functionality of the designed stress testing tool. Also, a benchmark was conducted against other three currently available stress testing tools to evaluate the features and data reports.

A. Stress Test

In evaluating the functionality of the components on the designed stress testing tool and to guarantee the accuracy of the performance evaluation reports, a stress test was conducted using two different web applications. The target applications were Online Auction System and Web-based Class Management System.

Stress test cases were conducted with different number of concurrent HTTP clients and intervals as described in Table II where the first test case was set to execute 2000 clients without interval, which means all of them were started immediately. The second test case was configured with 3000 clients with 100ms interval between each client.

1) *Stress Test Case 1 Summarized Results:* After stress test case 1 was conducted, statistical reports were compiled and analysed as presented in Table III, IV, and Figure 1.

The summarized server utilization report in Table III showed the maximum and average server utilization in two different test applications. It can be observed that the Online Auction System (OAS) used less CPU and Memory but noticeably consumed higher Network bandwidth on both received and transmitted data than the Class Management System (CMS). It was also displayed that the CMS had reached the 100% CPU usage which could have caused process congestion and refusal of requests.

In the summarized application performance report shown in Table IV the difference between the web pages and database queries response time was described. The longest web page response time on the Class Management System (CMS) reached up to 50.77 seconds while it only took 0.41 seconds in the Online Auction System (OAS). Also, the longest average response time of a web page in CMS was 6.11 seconds while in OAS it was only 0.07 seconds. The displayed results indicated the possibility of process congestion in the CMS considering that it reached 100% CPU utilization as shown in Table III. The CMS was also not able to report any database query results. In the succeeding sections, these results were further investigated to solidify the interpretation of the summarized reports.

2) *Stress Test Case 1 Online Auction System Report:* The statistical reports and visualized data provided by the WebSurge stress testing tool after stress test case 1 was conducted with Online Auction System was further inspected for analysis.

The maximum CPU utilization was at 97% and it occurred twice during Elapsed Time 36 and 40. Queued processes were also noticeably high during those events that reached up to 1127 processes. It was also shown that the critical level for CPU usage which was set at 70% was exceeded several times. The average CPU utilization was 31.47% but queued processes were consistently high with an average of 1113.77. The memory utilization report displayed the maximum memory utilization of 94.6% which was one of the instances where the memory critical utilization limit (90%) was exceeded. Also, the memory utilization had been consistently high throughout the test with an average of 91.35%. The transmitted data had a maximum rate of 12071 Kbps with maximum received rate of 501 Kbps. In summary, the web server utilization reports suggested that in order

TABLE II
STRESS TEST CASES

Test Case Number	Concurrent HTTP Clients	Clients Frequency Interval	Test Application
1	2000	0 ms	ICTS Online Auction System
			OLLES Class Management System
2	3000	100 ms	ICTS Online Auction System
			OLLES Class Management System

TABLE III
STRESS TEST CASE 1 SUMMARIZED SERVER UTILIZATION REPORT

Test Application	RESULTS							
	CPU		Memory		Network			
	Max.	Ave.	Max.	Ave.	Receive (Kbps)		Transmit(Kbps)	
					Max.	Ave.	Max.	Ave.
ICTS Online Auction System	97%	31.47%	94.6%	91.47%	501	172.11	12071	3432.48
OLLES Class Management System	100%	22.66%	95.51%	94.31%	160	4.69	478	11.41

TABLE IV
STRESS TEST CASE 1 SUMMARIZED APPLICATION PERFORMANCE REPORT

Test Application	RESULTS			
	Web Pages (Response Time)		DB Queries (Response Time)	
	Max. (seconds)	Average (seconds)	Max. (seconds)	Average (seconds)
ICTS Online Auction System	0.41	0.07	0.63	0.035
OLLES Class Management System	50.77	6.11	None	None

to handle 2000 simultaneous clients, the CPU and Memory capacity should be increased since critical usage was exceeded to prevent untoward errors due to insufficient resources; and it was also important to take note that the network bandwidth required was at least 12071 Kbps.

The web application performance reports displayed the maximum and average response time of web pages and database queries. phpMyItems had the longest response time but it only took 0.41 seconds. For the average web pages response time, the web page phpRegister had a value of 0, which indicated that an error had occurred wherein the page was not executed completely. The database queries had a maximum response time of 0.63 seconds and an average of 0.035 seconds on a total of 5060 queries. Based on the application performance reports, the web pages and database queries were performing well except that there was a page that

failed to execute. The individual performance criteria reports and visualizations were also provided for further review on the possible causes of errors and congestions.

3) *Stress Test Case 1 Class Management System Reports:* The server utilization reports for the Class Management System described the CPU, Memory, and Network utilization. The CPU had a maximum utilization of 100% that occurred four times where the first occurrence was just a second after the stress test was started. It can also be seen on the reports that the CPU critical limit was exceeded several times. The average CPU utilization was only 22.66% but the average utilization spent for waiting was very high at 71.75% and average queued processes of 2702.17 which signified that process congestion occurred. The memory utilization report also described high utilization percentage where several critical usages were identified with a maximum of 95.51%

STATISTICS SUMMARY

TIMESTAMP	ELAPSED TIME [seconds]	PAGE COUNT [active]	QUERY COUNT [active]	CPU USAGE [%]	MEMORY USAGE [%]	NETWORK TRANSMIT [%]	NETWORK RECEIVE [%]
05/09/2013 18:34:57	410	32	18	18	79.768619582456	0.222	0.117
05/09/2013 18:34:58	411	28	13	15	79.771734418681	5.281	0.188
05/09/2013 18:34:59	412	13	7	13	79.779781078927	1.895	0.153
05/09/2013 18:35:00	413	22	13	15	79.779261939557	2.96	0.13
05/09/2013 18:35:01	414	20	5	17	79.784193763579	2.965	0.131
05/09/2013 18:35:02	415	46	8	13	79.775887533647	2.834	0.136
05/09/2013 18:35:03	416	19	8	17	79.786010751376	0.656	0.118
05/09/2013 18:35:04	417	16	5	15	79.777185382074	1.32	0.129
05/09/2013 18:35:05	418	20	7	17	79.938118587006	6.547	0.195
05/09/2013 18:35:06	419	37	36	66	83.95911258316	10.806	0.27

Fig. 4. Stress Test Case 1 consolidated performance statistics.

and average of 94.32%. The network utilization had been consistently low at a maximum of 478 Kbps for transmitted data and 160Kbps received data. In general, the CPU and Memory capacity of the web server was not able to cater 2000 simultaneous clients where process congestion evidently occurred based on the reports.

In the summarized web pages and database queries performance report, it can be seen that the root page "/" had a maximum response time of 50.77 seconds and an average of 6.11 seconds which was very high for a functional web page. Two of the web pages were not able to finish its execution due to errors denoted by the 0 average response time. Also, none of the database queries were executed. These results coincided with the previous conclusion that process congestion occurred on the first request

on each client and was not able to continue the transactions.

4) *Stress Test Case 2 Summarized Results:* The stress test case 2 statistical reports and visualizations provided by WebSurge were used to conduct analysis on the capacity of the web server and the performance of the targeted applications.

Stress test case 2 was conducted with 3000 clients. It was observed that the Online Auction System did not reach the critical utilization limits on both CPU and Memory while the Class Management System reached as much as 100% CPU usage and 95.39% Memory usage which had both exceeded the critical limits. Thus, based on the reports it could be concluded that the web server was able to cater 3000 clients with 100ms interval on Online Auction System but was pushed to its limits on the Class

Management System.

The results displayed huge difference in web pages response time between OAS and CMS. The CMS was also unable to execute any database queries which could be associated to the critical utilizations on CPU and Memory. The succeeding sections presented the detailed reports provided by the WebSurge stress testing tool to further investigate and identify possible process congestions and errors.

5) *Stress Test Case 2 Online Auction System Reports:* The maximum CPU utilization during the stress test was 66% and it occurred at 419 seconds from the start of the stress test (Elapsed Time). It was also shown that the critical utilization limit on both CPU and Memory was not reached, which means that process congestion and memory outage related errors unlikely occurred. The maximum memory utilization was 86.34% and average utilization of 75.21%. It consumed as much as 12088 Kbps of the bandwidth which should also be considered when the application will be published to the internet. It can then be concluded based on the reports that the web server resource capacity was capable of handling 3000 clients with 100ms interval.

The application performance reports showed the Web application performance through web pages and database requests response time. The results displayed that most of the web pages had a maximum response time less than 0.05 seconds except the page /phpbid.php that reached up to a maximum response time of 0.39 seconds. Also, in web pages average response time was 0.04 seconds over 1000 page hits. It is also important to note that the value 0 in the average response time indicated an error occurred while executing the page and also needs careful inspection and review. The database queries had a maximum response time of 0.389 seconds and an average of 0.00819 seconds. In general, it could be seen that the web application had been performing well on the given settings.

6) *Stress Test Case 2 Class Management System Reports:* Web server utilization reports displayed identified process congestion occurred during the stress test. In several instances the maximum CPU utilization reached 100% and the first time it occurred was with the same time the stress test started. The average CPU usage was 43.22% and 87.56 processes per second were blocked. Also, the Mem-

ory utilization report showed a maximum utilization of 95.39% and an average of 94.25% which both exceeded the critical utilization limit. The network utilization had a maximum transmission rate of 1271 Kbps and maximum reception rate of 299 Kbps. It is clear, based on the results, that the web server resources, particularly the CPU and Memory, were not enough to cater 3000 clients with 100ms interval.

Consistent with the web server utilization results, the Web application performance report displayed that only the root page / and index.php was able to complete their execution. The longest response time took 67 seconds and there were no database queries were executed. It can then be concluded that most of the clients were not able finish their transactions due to process congestion. Further detailed statistical reports can be viewed using WebSurge stress testing tool to solidify the conclusion and identify possible causes of the congestion.

B. Benchmark

A benchmark was conducted together with three different stress testing tool the *httperf*, *WAPT*, and *Tsung*. Each of the software was executed with different configurations. Then the stress test applications reports were evaluated based on the adopted stress test and performance evaluation criteria.

Available statistical reports were compared with the existing stress testing tool. In the Processor metric, WebSurge provided statistical reports for maximum, critical, and average CPU utilization with their corresponding details and time of occurrence; while in *httperf* only the average CPU utilization was reported; *WAPT* does not have any reports on CPU utilization; and *Tsung* reported an overall minimum, maximum, and the average CPU utilization. In Processes metric WebSurge generated statistical reports on the process count, queue and blocked every second and their averages while the three other tools does not have any report related to processes. In Memory metric, WebSurge reported the maximum, critical, and average utilization statistics on both Physical Memory (RAM) and SWAP Memory with their components and the corresponding time it occurred while there were no reports provided in three other tools that were associated with memory statistics. In the Network metric, WebSurge was capable

TABLE V
STRESS TEST CASE 2 SUMMARIZED SERVER UTILIZATION REPORT

Test Application	RESULTS							
	CPU		Memory		Network			
	Max.	Ave.	Max.	Ave.	Receive (Kbps)		Transmit(Kbps)	
	Max.	Ave.	Max.	Ave.	Max.	Ave.	Max.	Ave.
ICTS Online Auction System	66%	15.46%	86.34%	75.21%	445	105.12	12088	2263.79
OLLES Class Management System	100%	43.22%	95.39%	94.25%	229	23.83	1271	59.39

TABLE VI
STRESS TEST CASE 2 SUMMARIZED APPLICATION PERFORMANCE REPORT

Test Application	RESULTS			
	Web Pages (Response Time)		DB Queries (Response Time)	
	Max. (seconds)	Average (seconds)	Max. (seconds)	Average (seconds)
ICTS Online Auction System	0.39	0.04	0.39	0.0082
OLLES Class Management System	67.03	2.03	None	None

STATISTICS SUMMARY

TIMESTAMP	ELAPSED TIME [seconds]	PAGE COUNT [active]	QUERY COUNT [active]	CPU USAGE [%]	MEMORY USAGE [%]	NETWORK TRANSMIT [%]	NETWORK RECEIVE [%]
05/09/2013 19:15:44	10	40	0	39	94.065458283258	0.192	0.251
05/09/2013 19:15:45	11	17	0	71	95.077260916852	0.22	0.322
05/09/2013 19:15:46	12	15	0	68	94.456629799119	0.138	0.313
05/09/2013 19:15:47	13	123	0	95	93.744370582448	0.384	0.855
05/09/2013 19:15:48	14	32	0	100	93.748004558044	1.487	0.463
05/09/2013 19:15:49	15	116	0	30	93.255600864886	0.206	0.163
05/09/2013 19:15:50	16	677	0	39	93.33399090987	0.736	0.255
05/09/2013 19:15:51	17	278	0	78	93.212252727428	4.016	0.534
05/09/2013 19:15:52	18	56	0	73	93.455469522625	1.66	0.263
05/09/2013 19:15:53	19	110	0	69	93.473898970287	1.537	0.327

Fig. 5. Stress Test Case 2 consolidated performance statistics.

TABLE VII
BENCHMARK CONFIGURATIONS

Stress-testing tool	No. of HTTP Clients	Interval per User (ms)	Concurrent Connections
1. WebSurge	1000	1000	N/A
2. HTTPERF	1000	N/A	150
3. WAPT	20	N/A	5
4. Tsung	1000	N/A	150

TABLE VIII
AVAILABLE STATISTICAL REPORTS

Performance Metrics	WebSurge	HTTPERF	WAPT	Tsung
Processor	Maximum Critical Average	Average	None	Maximum Minimum Average
Processes	Count Queue Blocked	None	None	None
Memory	RAM Swap	None	None	None
Network	Throughput Packets Count	Throughput	Throughput	Throughput
Response Times	Web Page Maximum Web Page Average DB Queries (Individual web page statistics)	Request (Min., Max., Ave.)	Request Average	Connection, Page, Request, Session (Min, Max, Ave)

of monitoring the data transfer rate (throughput) and the corresponding packet count while the rest of the tools reported only the average throughput. In the Response Time metric, WebSurge provided detailed individual web page statistics which included maximum and average response time together with the database queries executed and the number of individual page hit count; while httpperf reported the overall request statistics that included the maximum, minimum, and average response time; WAPT only provided the average request response time and Tsung generated statistical reports on the overall response time for connection, page, request, and session. Thus, WebSurge had several advantages in providing statistical reports based on the desired performance evaluation metrics.

IV. CONCLUSIONS AND RECOMMENDATIONS

After the study was conducted, we had come up with the following conclusion and recommendations:

1) *Conclusions:* A distributed profile-based stress testing tool with server utilization and application performance reports was developed. It was designed to provide sufficient number of HTTP clients that

could push the test application to its limit which was achieved through distribution of lightweight and fault tolerant software agents. The benchmark results also demonstrated that the developed stress testing tool had sufficient statistical reports compared to currently available benchmarked stress testing tools based on the desired performance criteria. Finally, the developed stress testing tool was able to demonstrate user-specified sequence of transactions derived from the sessions of a targeted web-based application and capable of replicating these transactions into multiple instances that pushed the target applications to their limit.

2) *Recommendations:* The WebSurge stress testing tool had several possibilities for improvement. The user interface can be further improved with more logical and user friendly design. The presentation of data can also be inspected with possible changes that could provide better comprehension and improve the speed on generating the results. Agents can also be upgraded to execute complicated transactions, and with better implementation of distributed application.

We also recommend that further analysis should be made on the statistical data for patterns and

behaviour in order to detect and prevent errors and congestions before it occurs. Also, suggestive module for the stress testing tool would be very beneficial to dynamically interpret the stress test results and provide possible solutions. Subsequent studies are also recommended to further explore the field of process concurrency and distribution using Erlang/OTP.

REFERENCES

- [1] DomainTools, "Domain counts and internet statistics," Retrieved 2010-11-12. [Online]. Available: <http://www.domaintools.com/internet-statistics/>
- [2] Information Age, "The 10 worst web application failures," Retrieved 2010-12. [Online]. Available: <http://www.information-age.com/articles/294446/the-10-worst-web-application-failures.shtml>
- [3] A. B. King, *Website Optimization*, 1st ed. O'Reilly, 2008.
- [4] C. Janssen, "Stress testing," Retrieved 2013-02-20. [Online]. Available: <http://www.techopedia.com/definition/15310/stress-testing-StressTesting>
- [5] R. Fielding, J. Gettys, J. Mogul, H. Frystyk, L. Masinter, P. Leach, and T. Berners-Lee, "Hypertext transfer protocol – HTTP/1.1," United States, 1999.
- [6] J. Armstrong, *Programming Erlang: Software for a Concurrent World*. Pragmatic Bookshelf, 2007.
- [7] J. Meier, C. Farre, P. Bansode, S. Barber, and D. Rea, *Performance Testing Guidance for Web Applications: Patterns & Practices*. Redmond, WA, USA: Microsoft Press, 2007.

Hydrodynamic Analysis of the ACCORDION Photobioreactor for Microalgae Cultivation using Computational Dynamics Analysis

Andres Philip Mayol, Aristotle Ubando, Joel Cuello, and Alvin Culaba

Abstract—Photobioreactors are promising growth container for microalgae species used in various disciplines such as chemical, pharmaceutical, biochemical, and environmental engineering. In addition, it has the advantage for closed environment conditions. Microalgae are microorganisms that have promise in biotechnology and energy sector. However, certain problem arises in cultivating microalgae in conventional photobioreactors. The main problem is improper mixing of culture media and air/CO₂ supply. Moreover, understanding the hydrodynamics of the photobioreactor aids a better reactor design using Computational fluid dynamics (CFD). This study aims to understand the hydrodynamics of the ACCORDION photobioreactor compared to the conventional airlift photobioreactor using CFD. Eulerian-Eulerian multiphase model was used to simulate the fluid flow inside the PBR. Bubble size was set to 0.006m, and sparge inside a 6 ft. ACCORDION PBR system. Results showed that the design of the ACCORDION PBR system improved the mixing strategy of the culture media (liquid) and air/CO₂ (gas). The CFD simulation of the ACCORDION PBR verified the goal of the design which is mixing. Results of this study shall aid in the design improvement of the ACCORDION photobioreactor system for microalgae cultivation.

Index Terms—photobioreactor (PBR), microalgae, ACCORDION, computational fluid dynamics, hydrodynamics.

A. P. Mayol is a graduate student of the Mechanical Engineering Department, De La Salle University, Manila, Philippines.

J. L. Cuello is with the Agricultural and Biosystems Engineering Department, The University of Arizona, Tucson, Arizona, USA.

A. Ubando and A. B. Culaba are with the Mechanical Engineering Department, De La Salle University, Manila, Philippines.

I. INTRODUCTION

MICROALGAE have different applications to offer in the pharmaceutical, cosmetics, agriculture, aquaculture, and energy industries [1], [2], [3], [4]. In addition, it also produces useful compounds that can be used in producing healthy food [5]. For environmental application, microalgae can remove pollutants from wastewater treatment and can be used for biofuels [6]. In space science application and research, microalgae are also utilized [7], [8]. Moreover, microalgae lessen CO₂ emissions that cause climate change. The energy streams that can be extracted from microalgae are bio-ethanol, methane, bio-gas [9], bio-hydrogen [10], bio-oil, and biodiesel [11], [12]. Biodiesel is one of the potential solutions as an alternative fuel in addressing fossil fuel depletion. Feedstocks such as soybean, corn, canola, coconut, and so forth are used to produce biodiesel. However, converting microalgae to biofuel involves processes from cultivation, harvesting, drying, oil extraction, to transesterification. To understand the growth of microalgae, the cultivation process must be considered in the study. Several cultivation systems are used for growing algae, such as raceway pond and photobioreactor (PBR) system [13]. For practical applications, raceway pond fits the criteria. However, it relies on weather conditions, and the microalgae species is prone to contamination. On the other hand, the PBR system does not rely on the weather condition, and it prevents microalgae contamination [11]. In addition, PBR system has several advantages such as more effective use of light absorption and less arable land area requirement than raceway pond system. However, there are several issues that need to be resolved in doing PBR system such as the mixing

of the culture medium with microalgae, CO₂ and air supply, light radiation uniformity, and reduced dead zones which can reduce microalgae productivity and photo-inhibition [14]. The ACClimatized bioreactOR for biomass production (ACCORDION) is an invention that provides efficient biomass production. It is a closed system of photobioreactor that is low cost and low maintenance [15]. It is a culture system not just for microalgae but also for different kinds of microorganisms or photosynthetic cells; this includes cyanobacteria. However, to investigate its hydrodynamics on how the aeration distribution of CO₂ and air inside the ACCORDION vessel, simulating and modeling proper mixing and reducing the cost in doing experiments, computational fluid dynamics (CFD) simulation is proposed as a methodology for this study.

CFD has proved to be reliable and provided realistic fluid simulations [16]. It can provide simulations and quantification of the hydrodynamics of the culture media inside a PBR system [14]. There are different studies that had been investigating in PBR systems. Van Baten et al. used CFX ANSYS to simulate airlift reactor and investigate its hydrodynamic flow and used a standard k-e turbulence model [17]. Krishna et al. used the same software CFX ANSYS to simulate a cylindrical bubble column to simulate highly viscous liquid phase that used standard k-e turbulence model [18]. To simulate the hydrodynamics of the PBR system, one must look into the multiphase of the system. There are several multiphase models such as the Eulerian-Eulerian, the multiphase mixture as mixture model, the volume of fluid (VOF), and the Discrete Phase Model (DPM) as an Eulerian-Lagrangian model. The focus of this paper is the Eulerian-Eulerian model. There are two fluids that are modeled in the study—water and air. To study the movement of a fluid, one must take into account differential equations especially the Navier-Stokes equations.

Problem Statement:

In designing photobioreactor culture systems for microalgae cultivation, different parameters must be considered, such as light penetration, gas injection, and most importantly, mixing [19].

To provide the microalgae or culture the exact nutrient that they need, nutrient distribution in the

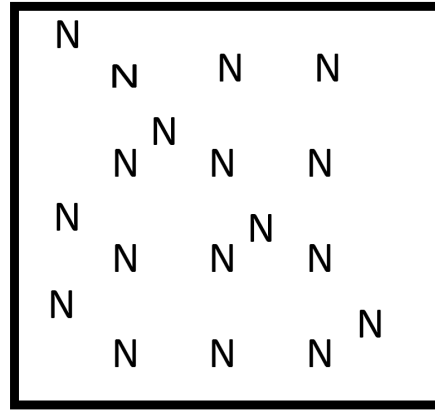

Fig. 1. Algae cultivation mixture.

vessel must be equal. In Figure 1, N = N in all areas in the photobioreactor system. Hence, the need for simulation using computational fluid dynamics, to demonstrate how the distribution of nutrients PBR is efficient inside the photobioreactor.

II. METHODOLOGY

A. Computational Fluid Dynamics Tools

Computational fluid dynamics is used in understanding the hydrodynamics of the culture media behavior inside the ACCORDION photobioreactor. The CFD simulation was used to solve the Navier-Stokes Equation with the aid of Reynolds theory. In explaining the fluid phenomena, computational domains were calculated using various equations—the mass, momentum, and energy conservation equations (1), (2), and (3). In designing the geometry, Design Modeler (ANSYS version 16.0) and MESH were used as pre-processors. CFX ANSYS version 16.0 was used to simulate the hydrodynamic simulation of the ACCORDION photobioreactor. Lastly, CFX-post (ANSYS version 16.0) was used to visualize the flows of the results inside the ACCORDION photobioreactor.

Mass:

$$\frac{\partial \rho}{\partial t} + \nabla \cdot (\rho \vec{v}) = S_m \quad (1)$$

Momentum:

$$\frac{\partial}{\partial t} (\rho \vec{v}) + \nabla \cdot (\rho \vec{v} \vec{v}) = -\nabla P + \nabla \cdot (\tau) + \rho \vec{g} + \vec{F} \quad (2)$$

Energy:

$$\begin{aligned} & \frac{\partial}{\partial t} \rho E + \nabla \cdot (\vec{v}(\rho E + P)) \\ & = \nabla \cdot \left(k_{\text{eff}} \nabla T - \sum h \vec{J} + (\tau_{\text{eff}} \vec{v}) \right) + S_h \end{aligned} \quad (3)$$

where:

- ρ = density (kg/m³)
- t = time(s)
- v = velocity (m/s)
- S_m = mass source (kg/m³)
- P = constant pressure (Pa)
- τ = stress tensor (Pa)
- g = gravitational acceleration (m/s²)
- F = external force (N/m³)
- E = total energy (J)
- k_{eff} = effective conductivity (cal/s)
- T = temperature (K)
- h = specific enthalpy (kcal/kg)
- J = diffusion flux (kg-m²/kg)
- τ_{eff} = effective stress tensor (Pa)
- S_h = total entropy (J/K)

B. Multiphase Model

Internal mixing inside the photobioreactor involves air and carbon dioxide (CO₂) which are formed bubbles in the media. Hence, using an appropriate multiphase model in simulating the hydrodynamics of the PBR system is necessary. There are two distinct multiphase models in ANSYS CFX—the Eulerian-Eulerian, and Eulerian-Lagrangian model. This study only involves Eulerian-Eulerian multiphase simulation. Eulerian-Eulerian multiphase model solves the most complicated conservation and multiphase equations. Thus, calculating time is longer. On the contrary, the Eulerian-Eulerian model produces accurate results [14]. Moreover, it is the average of Navier-Stokes equations over the volume; this includes arbitrary particles plus a continuous phase. Moreover, it solves the continuity and mass momentum equations such as fluid and solid phases. Lastly, it also tracks the volume fraction [20]. Using this multiphase model the pressure field is the same even if it is dispersed or continuous. The Eulerian-Eulerian model uses continuity (4) and momentum (5) equations and simultaneously solves them for each phase (6).

$$\begin{aligned} & \frac{\partial}{\partial t} (\alpha_p \rho_p) + \nabla \cdot (\alpha_p \rho_p \vec{v}_p) \\ & = \sum_{p=1}^n (m_{pq} - m_{qp}) + S_q \end{aligned} \quad (4)$$

$$\begin{aligned} & \frac{\partial}{\partial t} (\alpha_s \rho_s \vec{v}_s) + \nabla \cdot (\alpha_s \rho_s \vec{v}_s \vec{v}_s) \\ & = -\alpha_s \nabla p - \nabla P_s + \nabla \cdot \bar{\tau}_s + \alpha_s \rho_s \vec{g} \\ & \quad + K_{qs} (\vec{v}_q - \vec{v}_s) + F \end{aligned} \quad (5)$$

$$\begin{aligned} & \frac{\partial}{\partial t} (\alpha_q \rho_q \vec{v}_q) + \nabla \cdot (\alpha_q \rho_q \vec{v}_q \vec{v}_q) \\ & = -\alpha_q \nabla p + \nabla \cdot \bar{\tau}_q + \alpha_q \rho_q \vec{g} \\ & \quad + \sum_{p=1}^n \left(\vec{R}_{pq} + m_{pq} \vec{v}_{pq} - m_{qp} \vec{v}_{qp} \right) \\ & \quad + \left(\vec{F}_q + \vec{F}_{\text{lift},q} + \vec{F}_{\text{vm},q} \right) \end{aligned} \quad (6)$$

III. RESULTS AND DISCUSSION

Fluid flow in the ACCORDION PBR consisted of liquid and gas phases. The Eulerian-Eulerian multiphase model was used to compare ACCORDION with conventional airlift PBR system. The meshing of the ACCORDION was carried out having 21983 nodes and 108901 nodes. Figure 1 shows the meshing image of the ACCORDION reactor. Figures 2 and 3 display the air velocity profile and Pressure Contour of the ACCORDION PBR system. CFX-Pre domain was utilized, analysis type is steady state, and the fluid that was used in this study is air and water in the ANSYS CFX material list. Dispersed phase zero equation, fluid-dependent turbulence model, and the k-e turbulence model were used. The multiphase boundary conditions in the Inlet section is subsonic, the outlet is degassing, and the wall is no slip for water and slip condition for air.

Air velocity and its direction are important in designing PBR systems. Figure 2 shows the velocity profile of air from the sparger in the ACCORDION PBR system. The width of air flow inside the ACCORDION is increasing with respect to the height. However, there are still regions in the PBR which air

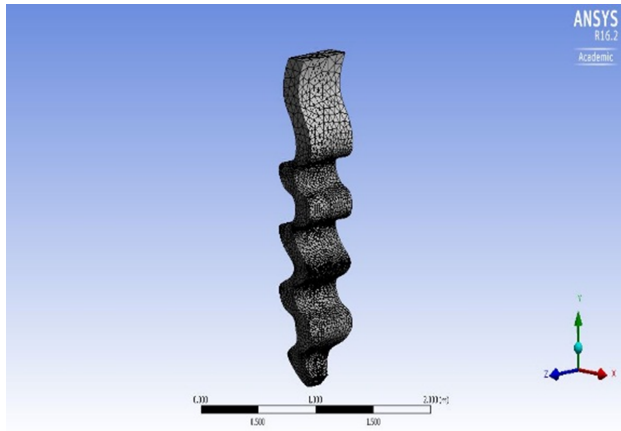

Fig. 2. Meshing of the ACCORDION PBR system.

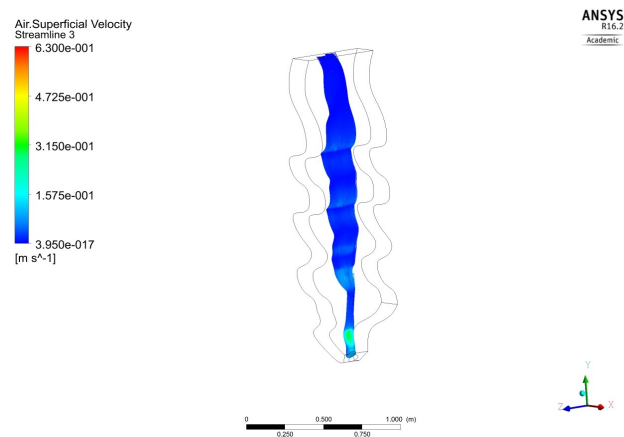

Fig. 4. Air superficial profile of ACCORDION PBR system.

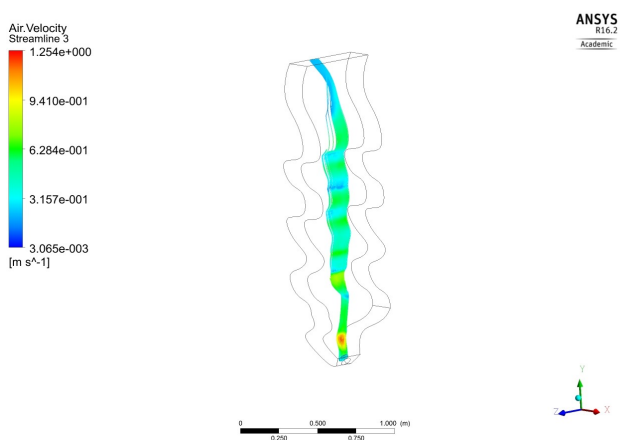

Fig. 3. Air velocity profile of the ACCORDION photobioreactor.

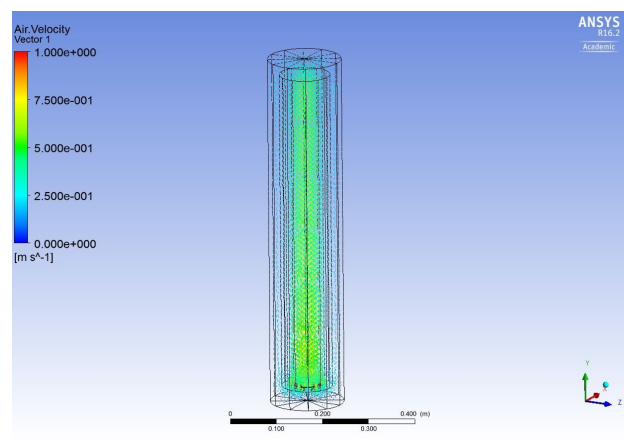

Fig. 5. Air superficial profile of ACCORDION PBR system.

does not penetrate, hence, dead zones are generated inside the ACCORDION.

The diameter of the air bubble was set to 0.006m. Due to its large diameter, the air bubble suddenly attained a significant terminal slip at a short time. This resulting terminal slip was obtained using Grace Drag model that is consistent with the forecast of Maneri and Mendelson, and Baker and Chao [20]. These correlations predict a terminal slip velocity of 0.23 m/s to 0.25 m/s for bubbles.

Figures 4 and 5 show the movement of air in a conventional PBR system. Figure 4 demonstrates how the air bubble behaves in a conventional airlift photobioreactor. Because of the draft in the middle of the airlift reactor, there has been a circulation inside the PBR system. It is supported by Figure

5, in which the initial flow of the air starts in the sparger and revolves in the draft tube inside the PBR system. Comparing the two PBR systems, the ACCORDION and the airlift bubble column PBR, different design shows different airflows. However, each of the system still involves dead zones that hinders mixture of air and nutrients in the reactor.

IV. CONCLUSION

Hydrodynamic analysis of the ACCORDION PBR system using CFD was initially established in this study. Using ANSYS CFX, Eulerian-Eulerian multiphase model was utilized to model the domain of the liquid and gas phases. The results of the simulation of the hydrodynamics analysis of the ACCORDION PBR system showed that the air bubbles do not penetrate in some areas, hence, having

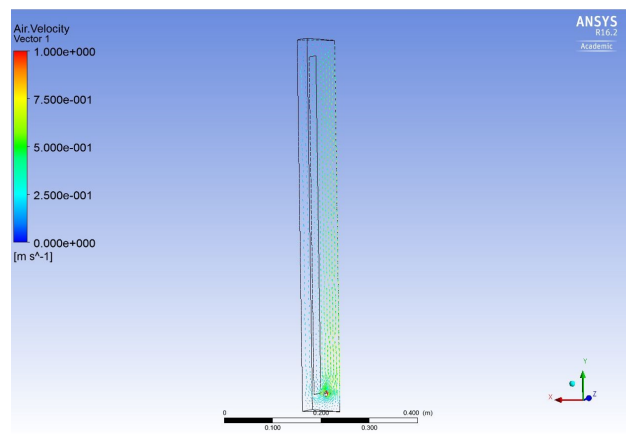

Fig. 6. Air superficial profile of ACCORDION PBR system.

dead zones in the photobioreactor and does not have proper mixing with nutrition. However, to improve the design of the PBR system, different design of PBR must be investigated and its bubble coalescence must be considered in designing. In designing PBR systems, solar penetration in the system must be considered. Moreover, monitoring the bubble hold up using Computational fluid dynamics with experimental method can aid the design of the photobioreactor.

ACKNOWLEDGEMENTS

We would like to acknowledge USAID STRIDE for funding this research.

REFERENCES

- [1] R. Ranjbar, R. Inoue, T. Katsuda, H. Yamaji, and S. Katoh, "High efficiency production of astaxanthin in an airlift photobioreactor," *Journal of Bioscience and Bioengineering*, vol. 106, no. 2, pp. 204–207, 2008.
- [2] O. Pulz and W. Gross, "Valuable products from biotechnology of microalgae," *Applied Microbiology and Biotechnology*, vol. 65, no. 6, pp. 635–648, 2004.
- [3] M. Olaizola, "Commercial development of microalgal biotechnology: From the test tube to the marketplace," *Biomolecular Engineering*, vol. 20, no. 4, pp. 459–466, 2003.
- [4] E. M. Grima, *Microalgae, Mass Culture Methods*. John Wiley & Sons, Inc., 2002.
- [5] M. A. Borowitzka, "Commercial production of microalgae: Ponds, tanks, tubes and fermenters," *Journal of Biotechnology*, vol. 70, no. 1, pp. 313–321, 1999.
- [6] S. Sawayama, S. Inoue, and S. Yokoyama, "Continuous culture of hydrocarbon-rich microalga *botryococcus braunii* in secondarily treated sewage," *Applied Microbiology and Biotechnology*, vol. 41, no. 6, pp. 729–731, 1994.
- [7] W. Ai, S. Guo, L. Qin, and Y. Tang, "Development of a ground-based space micro-algae photo-bioreactor," *Advances in Space Research*, vol. 41, no. 5, pp. 742–747, 2008.
- [8] D. Chaumont, "Biotechnology of algal biomass production: A review of systems for outdoor mass culture," *Journal of Applied Phycology*, vol. 5, no. 6, pp. 593–604, 1993.
- [9] A. S. Carlsson and D. J. Bowles, *Micro-and Macro-Algae: Utility for Industrial Applications: Outputs from the EPOBIO Project, September 2007*. Berkshire, UK: CPL Press, 2007.
- [10] V. Chochois, D. Dauvillée, A. Beyly, D. Tolleter, S. Cuiné, H. Timpano, S. Ball, L. Cournac, and G. Peltier, "Hydrogen production in chlamydomonas: Photosystem ii-dependent and-independent pathways differ in their requirement for starch metabolism," *Plant Physiology*, vol. 151, no. 2, pp. 631–640, 2009.
- [11] Y. Chisti, "Biodiesel from microalgae," *Biotechnology Advances*, vol. 25, no. 3, pp. 294–306, 2007.
- [12] M. Koller, A. Muhr, and G. Brauneegg, "Microalgae as versatile cellular factories for valued products," *Algal Research*, vol. 6, pp. 52–63, 2014.
- [13] M. A. Borowitzka and N. R. Moheimani, *Algae for Biofuels and Energy*. Dordrecht, Netherlands: Springer, 2013.
- [14] I.-h. Seo, I.-b. Lee, H.-s. Hwang, S.-w. Hong, J. P. Bitog, K.-s. Kwon, C.-g. Lee, Z.-h. Kim, and J. L. Cuello, "Numerical investigation of a bubble-column photo-bioreactor design for microalgae cultivation," *Biosystems Engineering*, vol. 113, no. 3, pp. 229–241, 2012.
- [15] J. L. Cuello and J. W. Ley, "Accordion bioreactor," Apr. 2014, uS Patent 8,709,808.
- [16] I. Seo, I. Lee, S. Hwang, S. Hong, J. Bitog, K. Kwon, C. Lee, Z. Kim, and J. Cuello, "Numerical investigation of a bubble-column photo-bioreactor design for biodiesel production from microalgae," in *Proceedings of the XVI-Ith World Congress of the International Commission of Agricultural and Biosystems Engineering, Quebec City, Canada, June, 2010*, pp. 13–17.
- [17] J. Van Baten, J. Ellenberger, and R. Krishna, "Hydrodynamics of internal air-lift reactors: Experiments versus cfd simulations," *Chemical Engineering and Processing: Process Intensification*, vol. 42, no. 10, pp. 733–742, 2003.
- [18] R. Krishna and J. van Baten, "Scaling up bubble column reactors with highly viscous liquid phase," *Chemical Engineering & Technology*, vol. 25, no. 10, pp. 1015–1020, 2002.
- [19] J. Bitog, I.-B. Lee, C.-G. Lee, K.-S. Kim, H.-S. Hwang, S.-W. Hong, I.-H. Seo, K.-S. Kwon, and E. Mostafa, "Application of computational fluid dynamics for modeling and designing photobioreactors for microalgae production: A review," *Computers and Electronics in Agriculture*, vol. 76, no. 2, pp. 131–147, 2011.
- [20] Fluent Inc., *Fluent 6.3 User's Guide*, Fluent Inc., Lebanon, NH, Sep. 2006.

Multiple Face Detection and Recognition Using HSV Histogram Matching and Principal Component Analysis Techniques

Alberto Bañacia, Mark Bryan Soylon, Sean Chris Conson,
Jonh Dennis Regidor, and Florencio Cortes

Abstract—Multiple face detection and recognition system using HSV Histogram Matching and Principal Component Analysis was successfully implemented in this study. The system setup consists of a Canon VB-C50i Network Camera that is used to capture the face images in a white background, perform face detection and recognition algorithms using Matlab installed in a laptop that also doubles as a database. The results show that HSV color space was successful in detecting a skin color with a white background resulting to a high precision and recall given that the positions of faces were varied. However, there were factors identified in this study that limited the systems detection capability, which include lighting conditions of the input image, the auto exposure feature of the Canon VB-C50i network camera, and the limitation of inverse cropping that was used for multiple face detection. The detected face(s) went through Principal Component Analysis. Euclidian distances were acquired to serve as the basis for face recognition. The system continued to loop until all the detected faces were recognized displaying a detected face with its corresponding profile. Recognition for multiple faces showed a higher rate in frontal orientation and fair rate on angled orientation of faces.

Index Terms—multiple face detection, multiple face recognition, feature invariant approach, color space, histogram matching, principal component analysis.

A. Bañacia is with the Department of Electrical & Electronics Engineering, University of San Carlos, Cebu City, Philippines.

M. B. Soylon, S. C. Conson, J. D. Regidor, and F. Cortes were students of the Department of Electrical & Electronics Engineering, University of San Carlos, Cebu City, Philippines.

I. INTRODUCTION

THE human face has a unique quality that is distinct for every individual. It is an innate capability in humans to identify people by merely their faces. The recognition process used by the human brain for identifying faces does not have a concrete explanation. This prompted the conduct of several researches to capture this characteristic in humans. Consequently, human face perception has been an active research area in content-based image functionality [1], [2], [3], [4].

Face detection and recognition have been significant subjects in the field of computer vision and image processing [5], [6], [7]. Face detection is the initial step to face recognition in the context of pre-processing by the way it deals with the location of the presence of a face in a still image or a sequence of images such as real-time videos. Likewise, face recognition has evolved from the basic face detection that has now proceeded to matching, verification, and identification.

The face is now being incorporated as a security measure to suit the needs of these systems. Further advances, specifically multiple face detection and recognition, have made it closer to that of a real human brain. This was implemented by capturing an image with faces to be detected, matched, and verified, then further recognizing the identity of the detected faces within the image through several different techniques.

One commonly used face detection technique is Histogram Matching [8]. This process garners a far more compact outline of the data within the image when joint probabilities of three certain color

space intensities are captured. Matching the input image histograms to that of the histogram of a given reference image makes it suited for face detection. Skin color is the commonly used information for face detection in color images [9], [10], [11]. The usage of skin color as a detection cue for face detection holds several advantages including the fact that human skin has a characteristic color easily recognized by humans, and processing facial skin color is much faster than processing any other facial features.

In 2006, histogram matching was used for precise motion and face detection. Face candidate was detected by analyzing the differences between two images, the reference image and the input image, using the Similarity Equation. Although the presence of erroneous detection was minimal, the histogram matching process using RGB histogram proved inefficient to be used in this study for it had many limitations and contained less information [12].

RGB is not very efficient when dealing with real color images. TSL model is considered to be the best color space for human eye perception. But the transformation of RGB to TSL is very time consuming. Mahesh Goyani et al., in their study, transformed RGB color space to HSV color space, identical to TSL [13]. They had cited the advantages of HSV color space over the mentioned color spaces. HSV color space is very close to human visual perception showing significant discrimination of skin color regions and takes less time for transformation compared to TSL.

On the other hand, Principal Component Analysis (PCA) has become a classical and statistical technique widely used to reduce the large dimensionality of the data space to lower dimensions for analysis that has made it an essential tool for data that need minute details for comparison such as face recognition [14]. Both studies in [15] and [16] exploited the use of PCA for face recognition [15] and automatic single face detection and tracking [16]. Their study had proved the accuracy and efficiency of PCA in recognizing faces one at a time. They recommended recognition of two or multiple faces at the same time. This motivated the authors to expand the study to include multiple face detection and recognition of up to four faces in a frame.

II. EXPERIMENTAL SETUP AND METHODOLOGY

The goal of the whole system was to implement an algorithm for multiple face detection and recognition using MATLAB software. The system comprised of the database, white board background, Canon network camera, and a laptop. The input image with the white background was captured through the Canon VB-C50i Network Camera and was further processed by the computer to detect and recognize the faces in the input image as illustrated in Fig. 1.

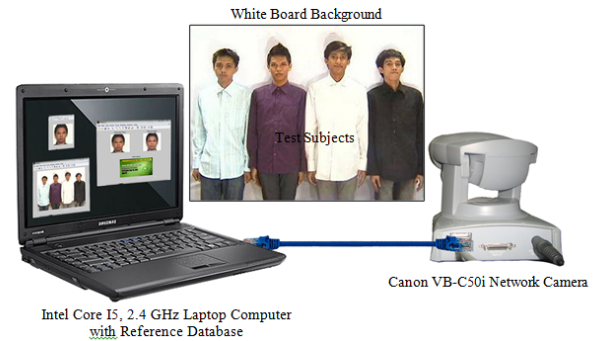

Fig. 1. Multiple face detection and recognition system setup.

HSV histogram matching technique was used to perform multiple face detection while Principal Component Analysis Technique was used to perform multiple face recognition. The output of the whole system was a display of the cropped images with their corresponding information as seen in Fig. 2.

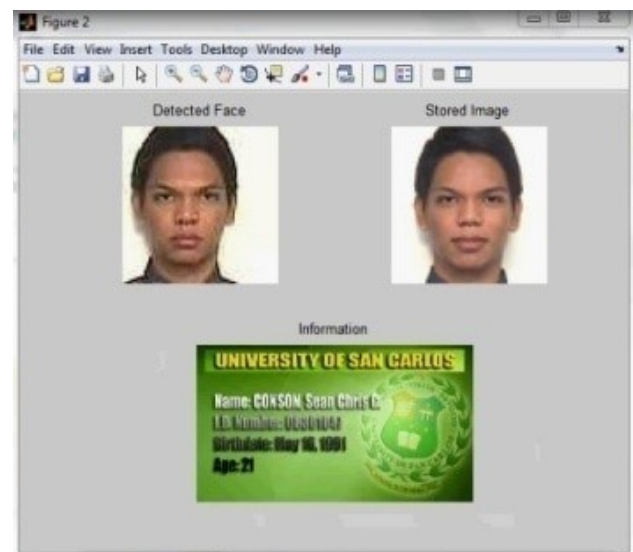

Fig. 2. Multiple face detection and recognition system output.

The database is comprised of face image used as references for multiple face detection. The training database is composed of several training sets of images for each individual person of various angles, and personal profiles for each subject used in multiple face recognition. The database was created using MATLAB.

The system has two main stages, namely multiple face detection and multiple face recognition. First, the number of faces to be detected within the input image was set. The system acquired an input image of 384x288 pixels and was compared to the reference image using similarity equation, through a sliding window technique. The first detected face was cropped from the input image and inverse cropping was done to the input image. The resulting inversed cropped image became the input of the system for the 2nd face detection and so on. The system repeated the same process until all faces within the input image was detected. The cropped detected faces became the input images for multiple face recognition. PCA was applied to the detected faces and was compared to the train database to match and recognize the detected faces. Each recognized faces together with its corresponding profiles were displayed by the system.

A. Multiple Face Detection

A reference image was acquired and divided into 3x3 sub-regions. The RGB color space of the reference image was converted into HSV color space. An HSV histogram for every sub-region of the reference image was introduced. Each region was composed of three histograms namely hue, saturation, and value. An input image was obtained from the camera which was divided into 16 columns and 12 rows for the purpose of manipulating the coordinates. The number of faces to be detected within the input image was set. The color histogram for each 3x3 region was acquired and converted from RGB to HSV and compared to the reference image using the similarity equation:

$$S_{HM}(x, y) = \frac{1}{3D} \sum_{j=1}^D \sum_{c \in (H,S,V)} \sum_{i=1}^L (H_{cj}(i) - M_{cj}(x, y)) \quad (1)$$

According to equation (1), for every column, D is the difference between the intensity level, L for every element of hue, saturation, and value, c in each sub-region of the reference image, H and the input image, M . The sub-region also indicated the coordinates, x, y in the system. The sub-region with the least value indicated the detected face with its coordinates. Using the sliding window technique, the reference image was compared to each 3x3 region of the input image and continued to scan the rest of the frame from left to right. This is illustrated in Fig. 3.

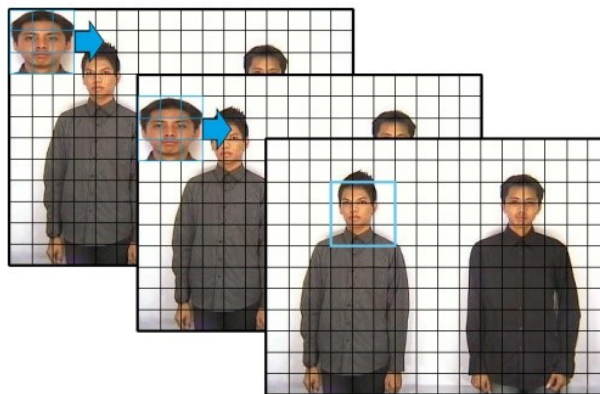

Fig. 3. Reference image scanning for maximum similarity.

The coordinates of the 3x3 region with maximum similarity determined the detected faces of the input image and was cropped. Given the distance between the subjects and the network camera, 3x3 cropping was used to make sure that the whole face was cropped and avoid cutbacks in face detection.

Inverse cropping was then employed for the detected face and the resulting inverse cropped image served as the new input image for the second face detection as shown in Fig. 4.

The process was repeated until the detected images reached the limit, N set by the proponents. Simultaneously, the cropped detected faces were saved automatically and were later recalled in the recognition part of the system and this completed the process for multiple face detection (see Fig. 5).

B. Multiple Face Recognition

For multiple face recognition, train database of varying face images was created in order to define the unique features of the detected face. This



Fig. 4. Inverse cropping of the input image.



Fig. 5. The detected cropped faces.

database became the basis in acquiring the average face vector, eigenvalues, and Euclidean distances that was used in the process of image matching and recognition (see Fig. 6).

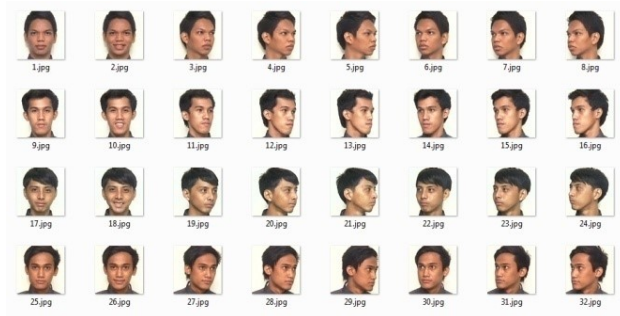

Fig. 6. Train database for face matching and recognition.

Equation (2) was used to obtain the mean image, Ψ of the train database where Γ_i is the image vector of the database and M is the number of image vector.

$$\Psi = \frac{1}{M} \sum_{i=1}^M \Gamma_i \quad (2)$$

The deviation of each image from the mean image in the database was calculated using the processed

face vector, Φ_i of equation (3):

$$\Phi_i = \Gamma_i - \Psi \quad (3)$$

The output was used to obtain the covariance matrix of the training images using the covariance matrix, C of equation (4) where Φ_i is the processed face vector, and Φ_i^T is the transposed processed face vector.

$$C = \frac{1}{M} \sum_{i=1}^M \Phi_i \Phi_i^T = A^T A \quad (N^2 \times N^2 \text{ matrix}) \quad (4)$$

Values that were obtained in the covariance matrix, eigenvector of $A^T A$, v_i , and eigenvalues, μ_i were computed using the eigenvector equation in (5). The largest eigenvalues were sorted to get the most excellent approximations of the face projected into eigenspace.

$$A^T A v_i = \mu_i v_i \quad (5)$$

Eigenvectors of covariance matrix (eigenfaces) were obtained from the centered image vectors. All the centered images were projected to eigenspace, $\hat{\Phi}$ by multiplying it to the eigenfaces basis. Getting the projected vector of each face was done by using the eigenspace equation (6) and with the corresponding feature vector. And Φ is the processed face vector of the new/unknown image.

$$\hat{\Phi} = \sum_{i=1}^K w_i v_i \quad (w_i = v_i^T \Phi) \quad (6)$$

Principal Component Analysis (PCA) features from test image were extracted after projecting all the centered images into eigenspace. The Euclidean distances, e_d between the projected centered image and the projected test image was calculated using (7). The test image should be in the minimum Euclidean distance with its corresponding image in the training database.

$$e_d = \|\Phi - \hat{\Phi}\| \quad (7)$$

The minimum Euclidean distance served as the basis for recognizing the input image for it is supposed to have minimum Euclidean distances with its corresponding image in the training database.

If the e_d was less than $6.7080e+13$ an image was recognized with a corresponding match. When potential matches were found from the reference images stored in the database, the system stored the image together with their respective profiles. The process continues to repeat itself for the remaining faces detected until all of the detected faces were processed. When all faces were recognized, the system had identified the images by displaying the cropped face image from the multiple face detection process together with its corresponding profile about the individual as stored in the database.

III. RESULTS AND DISCUSSION

A. Sampling Technique for Multiple Face Detection

There were two reference images used for multiple face detection. One reference image constitutes a darker reference image (Figure 7) while the other comprised of brighter reference image (Figure 8).

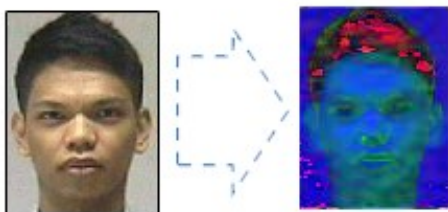

Fig. 7. Ref1 HSV Conversion.

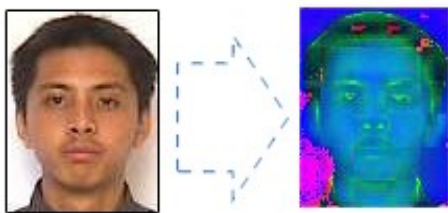

Fig. 8. Ref2 HSV Conversion.

An input image with four faces was captured and the conversion from RGB to HSV model was established as shown in Figure 9.

From Figure 9, it was noticeable what color constitutes the faces in HSV model. It appeared that the blue-green color served as the faces which were



Fig. 9. Conversion of RGB to HSV color space of the input image.

distinct from any other color in the image. Thus, when compared to the two reference images, the location of the maximum similarity was in the region where faces were located. Other blue-green color was characterized by the hands with slight similarity to the reference image.

For testing the detection of multiple faces, the input image was compared to the two reference images.

For each reference image, series of tests for one face, two faces, up to four faces detection were conducted under different lighting conditions. The different lighting conditions that were taken into account for the system were classified as controlled lighting, room lighting, and ambient lighting. For controlled lighting, the lighting condition for the set-up was room light then controlled using four CFL bulbs placed in front of the subjects for further illumination purposes. The blinds were closed thus; the setting was not affected by the external light. Room lighting only required light from the inside of the room or normal room lighting. In this condition, the blinds attached to the windows were closed, thus the system was not affected by the light coming from the outside.

In the case of ambient lighting, it required light from the outside. Blinds attached to the windows were opened to allow light to pass into the room. Aside from the different lighting conditions, the subjects were also tested at different positions for two faces, three faces, and four faces as to test whether the system was able to detect the faces at different areas within the frame of the camera. These were shown in figures 10, 11, and 12.

The efficiency for the multiple face detection was determined by the precision and recall equation used in [13]. Precision is a percentage expressed as the



Fig. 10. Two faces in varied positions.



Fig. 11. Three faces in varied positions.



Fig. 12. Four faces in varied positions.

number of relevant data, A to the total number of relevant data and irrelevant data, B . Equation (8) was used to calculate the precision.

$$\text{PRECISION} = \frac{A}{A + B} \times 100\% \quad (8)$$

While recall is a ratio of the number of relevant data to the number of relevant data and relevant data not retrieved, C .

$$\text{RECALL} = \frac{A}{A + C} \times 100\% \quad (9)$$

B. Multiple Face Detection Testing

For each reference image, 100 samples were obtained from each of the inputs with two faces, three faces, and four faces. The number of correct face detection constitute all faces that were properly cropped and without any cutbacks. Detection of hands and only portions of a face comprised the number of incorrect detection. Moreover, detection of white background and parts of the clothing consist of the number of no face detection as shown in Figures 13, 14, and 15.

For each reference image, 100 samples were obtained from each of the single face, two faces, three faces, and four faces. The process was repeated for the three lighting conditions to make it a 1200

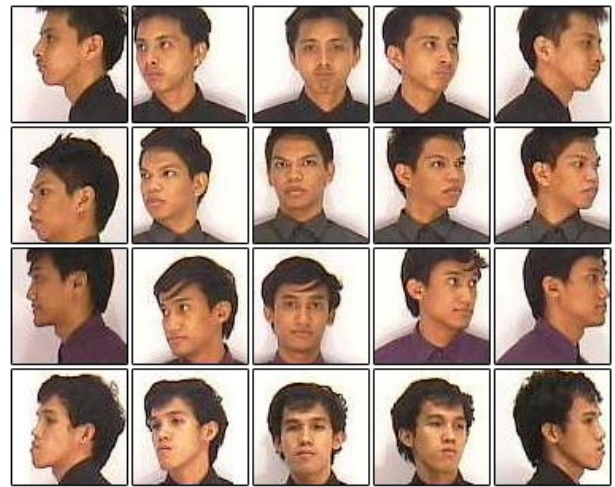

Fig. 13. Correct face detection.



Fig. 14. Incorrect face detection.



Fig. 15. No face detection.

samples resulting to a total of 2400 for the two reference images.

For single face detection, reference image 2 showed better results in terms of precision than reference 1 at all lighting conditions and performed better in recall for the ambient and controlled lighting condition. Reference 1 had higher recall in normal lighting condition.

In two face detection, reference image 2 had better precision for controlled and ambient lighting condition but performed less in normal room lighting. Reference 1 had higher recall for controlled and room lighting condition but lesser in ambient lighting.

In three face detection, reference image 2 showed better results in terms of precision for all lighting

TABLE I
SINGLE FACE DETECTION PRECISION AND RECALL

Single Face Input					
Controlled Lighting					
Reference Image Used	No. of Correct Face Detection	No. of Incorrect Face Detection	No. of No Face Detection	Precision (%)	Recall (%)
ref1	92	3	5	96.84	94.85
ref2	97	2	1	97.98	98.98
Normal Room Lighting					
ref1	88	12	0	88.00	100.00
ref2	93	2	5	97.89	94.90
Ambient Lighting					
ref1	79	19	2	80.61	97.53
ref2	94	6	0	94.00	100.00

TABLE II
TWO FACE DETECTION PRECISION AND RECALL

Two Face Input					
Controlled Lighting					
Reference Image Used	No. of Correct Face Detection	No. of Incorrect Face Detection	No. of No Face Detection	Precision (%)	Recall (%)
ref1	92	7	1	92.92	98.92
ref2	91	7	2	92.86	97.85
Normal Room Lighting					
ref1	92	7	1	93.88	98.92
ref2	89	9	2	90.82	97.80
Ambient Lighting					
ref1	66	12	22	84.62	75.00
ref2	94	1	4	98.95	95.92

conditions and had higher recall for controlled and ambient lighting condition. Reference 1 showed better result in terms of recall under room lighting condition.

For four face detection, reference 2 had the higher precision for all lighting conditions and had better recall for controlled and ambient lighting unlike reference 1, the performance was better in terms of recall for room light condition.

C. Multiple Face Recognition

The database for matching and recognition was composed of training sets; Set 1 was consisted of images 1 to 8, Set 2 consisted of 9 to 16, Set 3 consisted of 17 to 24, and Set 4 consisted of 25 to 32 as shown in Figure 16.

D. Multiple Face Detection Testing

One hundred samples were acquired for one, two, three, and four faces recognition. For one face,

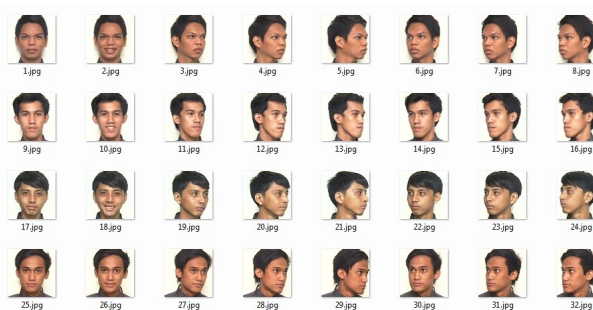

Fig. 16. Training sets: set 1, set 2, set 3, and set 4 (respectively per row).

two faces, and four faces recognition, 52 frontal orientation of the face and 48 angled orientations, varying from 45° to 90°, of the face were taken. For three face recognition, 66 frontal orientations were obtained and 34 angled shots were taken.

The maximum Euclidean distance as a threshold for failed recognition was set to 6.7080e+13. This

TABLE III
THREE FACE DETECTION PRECISION AND RECALL

Three Face Input					
Controlled Lighting					
Reference Image Used	No. of Correct Face Detection	No. of Incorrect Face Detection	No. of No Face Detection	Precision (%)	Recall (%)
ref1	48	43	9	52.75	84.21
ref2	93	7	0	93.00	100.00
Normal Room Lighting					
ref1	57	35	8	61.96	87.69
ref2	75	22	3	77.32	96.15
Ambient Lighting					
ref1	74	21	5	77.89	93.67
ref2	92	5	3	94.85	96.84

TABLE IV
FOUR FACE DETECTION PRECISION AND RECALL

Four Face Input					
Controlled Lighting					
Reference Image Used	No. of Correct Face Detection	No. of Incorrect Face Detection	No. of No Face Detection	Precision (%)	Recall (%)
ref1	47	38	15	55.29	75.81
ref2	94	1	5	98.95	94.95
Normal Room Lighting					
ref1	74	10	16	88.10	82.22
ref2	66	7	27	90.41	70.97
Ambient Lighting					
ref1	68	28	4	70.83	94.44
ref2	80	18	2	81.63	97.56

was done by a series of tests which gave a recognition output of no match found given a no face input. Out of all the results, the minimum Euclidean distance was chosen as the threshold fail recognition. Any Euclidean distance between the projected detected/test image that go beyond the set maximum Euclidean distance was automatically considered as failed recognition.

The output of the testing was categorized as correct, incorrect, and failed recognition.

Correct recognition happened when the detected face was matched to its corresponding image in the database and displayed its corresponding profile as shown in Figure 18. It also included the display of a no match found if the detected/test image did not have any training set in the database.

The Euclidean distance between the detected image and the projected feature vector of its corresponding image in the database was at its minimum as shown in Table V.

Incorrect recognition occurred when the detect-

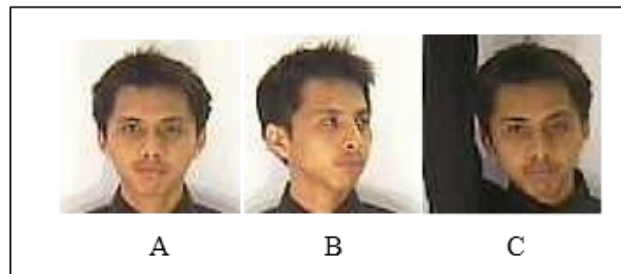

Fig. 17. Detected/test images.

TABLE V
EUCLIDEAN DISTANCES FOR CORRECT RECOGNITION

Training Set	Test Image	Euclidean Distance
1	A	5.7582e+13
2	A	1.0224e+14
3	A	5.4189e+13
4	A	1.8094e+14

ed/test image was matched to the wrong image in



Fig. 18. Display of correct recognition.



Fig. 19. Display of incorrect recognition.

TABLE VI
EUCLIDEAN DISTANCES FOR INCORRECT RECOGNITION

Training Set	Test Image	Euclidean Distance
1	B	1.0939e+14
2	B	4.9674e+13
3	B	6.1631e+13
4	B	1.5847e+14

TABLE VII
EUCLIDEAN DISTANCES FOR FAILED RECOGNITION

Training Set	Test Image	Euclidean Distance
1	C	2.8379e+14
2	C	1.1180e+14
3	C	1.0817e+14
4	C	1.3958e+14



Fig. 20. Display of failed recognition.

the database. Refer to Figure 19.

The Euclidean distance between the detected image and the projected feature vector of the wrong match image in the database was at its minimum as indicated in Table VI.

Failed recognition occurred when the detected/test image was not matched or was not recognized by the system and displayed a no matched found even if detected/test image had a training set in the database as shown in Figure 20. It also included a display of a match image in the database even if the detected/test image was incorrect.

For the detected/test image C, the minimum Euclidean distance exceeded the set threshold which

was 6.7080e+13, thus it displayed “No Match Found”.

The efficiency of multiple face recognition was determined by the precision and recall equation.

The tables showed the precision and recall of face recognition for different number of detected/test images varies from one- to four-face recognition. Frontal face orientation obtained a better precision compared to that of the angled face orientation.

TABLE VIII
PRECISION AND RECALL FOR SINGLE FACE RECOGNITION

Single Face Input					
Ref. 2	Correct Recognition	Incorrect Recognition	Failed Recognition	Precision (%)	Recall (%)
Frontal	36	16	0	69.23	100
Angled	18	30	0	37.50	100

TABLE IX
PRECISION AND RECALL FOR TWO FACE RECOGNITION

Two Face Input					
Ref. 2	Correct Recognition	Incorrect Recognition	Failed Recognition	Precision (%)	Recall (%)
Frontal	28	24	2	52.00	92.86
Angled	18	27	3	40.00	85.71

TABLE X
PRECISION AND RECALL FOR THREE FACE RECOGNITION

Three Face Input					
Ref. 2	Correct Recognition	Incorrect Recognition	Failed Recognition	Precision (%)	Recall (%)
Frontal	35	25	6	58.33	85.37
Angled	13	17	4	43.33	76.47

TABLE XI
PRECISION AND RECALL FOR FOUR FACE RECOGNITION

Four Face Input					
Ref. 2	Correct Recognition	Incorrect Recognition	Failed Recognition	Precision (%)	Recall (%)
Frontal	19	23	10	45.23	65.52
Angled	15	22	11	40.54	57.69

IV. CONCLUSION

Multiple face detection and recognition using HSV Histogram Matching and Principal Component Analysis (PCA) technique was successfully implemented in this study.

HSV color space that was used for histogram matching for face detection showed a high precision and recall given that the position of faces were varied. In addition, changing reference image depending on the different lighting conditions increased the precision of the detection algorithm. The results showed that HSV color space was successful in detecting a skin color with a white background. However, there were factors identified in this study that limited the systems detection capability. These include lighting conditions of the input image, the auto exposure feature of the Canon VB-C50i network camera, and the limitation of inverse cropping that was used for multiple face detection.

Obtaining precise value for average face vector, eigenvalues, and Euclidean distances for recognition was improved when different angle variations in the training sets were provided. Moreover, setting the threshold for maximum Euclidean distance to $6.7080e+13$ lessened the reconstruction error of the detected face and training set that was projected in face space for comparison, thus improving the precision in face recognition. Frontal orientation of face showed higher success rate in recognition than angled orientation. Therefore, PCA recognition can be used for recognition with different face orientations at a cost of low precision provided that sufficient images were stored in the database. However, there were factors that limit the accuracy of the recognition. These were the face position of the detected image, face orientations that were not included in the training set, unwanted objects that were included in cropped detected face, and lighting conditions.

The system is currently being tested with complex background. Initial results show the need for more robust multiple face detection technique as the use of histogram matching with inverse cropping shows problems with faces located near the edge of the image. There is also a need to increase the training sets in the database to improve the capability of PCA to recognize faces. The use of a high definition camera that can provide high quality images as input to the detection system and training sets for the database recognition system is also being considered to increase the accuracy of face recognition.

REFERENCES

- [1] K. Ramirez-Gutierrez, D. Cruz-Perez, J. Olivares-Mercado, M. Nakano-Miyatake, and H. Perez-Meana, "A face recognition algorithm using eigenphases and histogram equalization," *International Journal of Computers*, vol. 5, no. 1, pp. 34–41, 2011.
- [2] S. Cooray and N. O'Connor, "A hybrid technique for face detection in color images," in *Advanced Video and Signal Based Surveillance, 2005. AVSS 2005. IEEE Conference On*. IEEE, 2005, pp. 253–258.
- [3] M.-H. Yang, D. J. Kriegman, and N. Ahuja, "Detecting faces in images: A survey," *Pattern Analysis and Machine Intelligence, IEEE Transactions On*, vol. 24, no. 1, pp. 34–58, 2002.
- [4] M.-H. Yang, "Recent advances in face detection," *IEEE ICPR 2004 Tutorial*, 2004.
- [5] P. Kuchi, P. Gabbur, P. S. Bhat, and S. S. David, "Human face detection and tracking using skin color modeling and connected component operators," *IETE Journal of Research*, vol. 48, no. 3-4, pp. 289–293, 2002.
- [6] K. Kim, "Face recognition using principle component analysis," in *International Conference on Computer Vision and Pattern Recognition*, 1996, pp. 586–591.
- [7] NSTC Subcommittee on Biometrics, "Face recognition," 2006. [Online]. Available: <http://biometrics.gov/Documents/facerec.pdf>
- [8] D. Cromey, "Image processing using the histogram tool," 2004. [Online]. Available: <http://swehsc.pharmacy.arizona.edu/expath>
- [9] V. Vezhnevets, V. Sazonov, and A. Andreeva, "A survey on pixel-based skin color detection techniques," in *Proc. Graphicon*, vol. 3. Moscow, Russia, 2003, pp. 85–92.
- [10] S. K. Singh, D. Chauhan, M. Vatsa, and R. Singh, "A robust skin color based face detection algorithm," *Tamkang Journal of Science and Engineering*, vol. 6, no. 4, pp. 227–234, 2003.
- [11] N. Rasiwasia, "Color space for skin detection – a review," 2005. [Online]. Available: <http://www.svcl.ucsd.edu/~nikux/skin/Color%20Space%20for%20skin%20segmentation.ppt>
- [12] C. Bejec, N. Marañón, M. Niniel, J. Racho, R. Tillano, and A. Bañacia, "Automatic face detection and tracking using motion detection and histogram-matching," Bachelor's thesis, University of San Carlos, Cebu City, Philippines, 2006.
- [13] M. Goyani, B. Joshi, and G. Shikkenawis, "Acceptance/rejection rule based algorithm for multiple face detection in colour images," *International Journal of Engineering Science and Technology*, vol. 2, no. 6, pp. 2148–2154, 2010.
- [14] T. Hassner and Z. Zeljik-Manor, "Principal component analysis, eigenfaces and fisher discriminant," Weizmann Institute of Science, Israel.
- [15] A. Jimenez, J. Morales, J. Tomarong, C. Tumulak, and A. Bañacia, "PCA-based face recognition," Bachelor's thesis, University of San Carlos, Cebu City, Philippines, 2008.
- [16] A. Cabural, D. Catarig, M. Evangelista, J. Go, M. Matillano, and A. Bañacia, "Automatic face detection and tracking using motion detection and histogram-matching," Bachelor's thesis, University of San Carlos, Cebu City, Philippines, 2007.

ABOUT THE CONTRIBUTORS

Lateef Olayanju

Lateef O. Olayanju (PhD) received his MSc and PhD degrees from Coventry University, UK, in 2009 and 2014, respectively. He is a Public Health Informatics professional and his research interest cuts across multiple fields of socio-behavioural science, public health and computing. He collaborates with international research / academic establishments, such as BIOCORE Research & Consultancy International, on health-related research projects, and has worked as Information Analyst with the National Health Service (NHS) in England. His current research focuses on exploring issues of Intimate Partner Violence in developing countries.

Raouf Naguib

Raouf N.G. Naguib (PhD) obtained both his Master's degree (with Distinction) and Doctorate degree from Imperial College, University of London, UK, in 1983 and 1986, respectively. He is the Director of BIOCORE Research and Consultancy International, UK and Visiting Professor at Liverpool Hope University, UK. He has published two books and over 360 journal and conference papers and reports in many aspects of health informatics, environmental health, social health, biomedical and digital signal/image processing, and the applications of artificial intelligence and evolutionary computation in cancer research. He was awarded the Fulbright Cancer Fellowship in 1995–1996 when he carried out research in the USA on the applications of artificial neural networks in breast cancer diagnosis and prognosis. He is a member of several national and

international research committees, boards and review panels, an Adjunct Research Professor at the University of Carleton, Canada, a Visiting Professor at Dai Nam University, Vietnam and an Honorary Professor at De La Salle University, Philippines.

Saad Amin

Saad Amin (PhD) is a Principal Lecturer at Coventry University, UK. His area of research is Health Informatics and he has published many journal and conference papers in this field. He has also been involved in organising international conferences, as well as served on programme committees and acted as Session Chair for many international conferences.

Quynh Nguyen

Quynh T. Nguyen (PhD) is an IBM-certified SPSS specialist and statistician, having obtained her Master's degree (with Distinction) and PhD from Coventry University, UK, in 2007 and 2011, respectively. Over the last 10 years, she worked on the integration of different datasets within geographical information systems, health informatics, environmental systems and web site defacement detection. She currently works with BIOCORE Research & Consultancy International, UK, and has been recently appointed as Lecturer at RMIT University Vietnam, as well as Visiting Professor at Dai Nam University, Vietnam. She published 30 peer reviewed journals and conferences papers and is an invited speaker at De La Salle University,

Manila, Philippines. In addition to the above areas of work, her research interests include information retrieval, data extraction and mining, and environmental health in developing countries.

Olabode Kayode

Olabode O. Kayode (PhD) is Professor of Public Health Promotion and Health Education at University of Ilorin, Nigeria. He received his MPH from the University of North Carolina at Chapel-Hill and PhD from the University of Ilorin in 1979 and 2006, respectively. He has vast teaching and research experience in the field of public health, and has served as consultant to the UNICEF and to a number of NGOs.

Oluwatosin Olayanju

Oluwatosin A. Olayanju (MA) received his Master's in Peace and Reconciliation Studies from Coventry University, UK. He is a Social Justice Advocate in Nigeria and the co-founder of a civil society (People's Reformation and Intellectual Movement for Empowerment - PRIME) in the country. His major areas of interest are Gender Equality and Human Rights.

Gil Nonato Santos

Gil Nonato C. Santos (PhD) is a Full Professor and the Chairman of the Physics Department, De La Salle University, Manila, Philippines. He has a Master's degree in Physics and Doctorate degree in Materials Science and Engineering from the University of the Philippines. He is a Research Fellow at the University of Fukui, and a Visiting Professor at Osaka and Howard Universities. He is the Research Head of the Solid State

Physics Research Laboratory and published local and international publications in nanomaterials. He is the author of several textbooks in science, maths and computer technology. He is a member of the International Association of Engineers, Samahang Pisika ng Pilipinas, Philippine Physics Society and Ex-Officio Chair of the Microscopy Society of the Philippines. He was awarded the Most Outstanding Service in Physics award in 2010 by the Philippine Physics Society.

Roy Francis Navea

Roy Francis Navea was born in Biñan, Laguna on April 25, 1981. He received the B.S. degree in Electronics and Communications Engineering (ECE) from the Mapua Institute of Technology, Intramuros, Manila in 2003, and the M.S. degree in ECE from De La Salle University, Manila in 2012. He is now a PhD in ECE candidate in De La Salle University with his dissertation focusing on the analysis of musically stimulated brain wave signals.

Currently, He is an Assistant Professor in the Electronics and Communications Engineering of De La Salle University, Manila. He is also the ECE program coordinator at the De La Salle University – Science and Technology Campus in Biñan, Laguna. His research interests include digital signal processing, artificial/computational intelligence, bioinformatics and wavelet analysis.

Elmer Dadios

Dr. Elmer P. Dadios finished his doctoral degree for an unprecedented two years at Loughborough University (Department of Manufacturing Engineering), United

Kingdom in 1996. He is an *editor* of the Journal of Advanced Computational Intelligence and Intelligent Informatics (JACIII) published by FUJI Press Tokyo, Japan; He is a member of the Editorial Board of International Journal of Advanced Robotic Systems published by INTECH Croatia. He is the *Organizing Chair* of the IEEE TENCON 2012 International Conference. He is the *General Chair* of the IEEE Technical Sponsored International Conference on Humanoid, Nanotechnology, Information Technology, Communication and Control, Environment, and Management (HNICEM). He is the Program Chair of the 13th International Conference on Mechatronics Technology (ICMT 2009). He was the *Publicity Chair* of the 2002 IEEE ISIC International Conference held in Vancouver, Canada. He is the Founder and Currently the Chair of the IEEE Computational Intelligence Society, Philippines. He is currently a member of the IEEE Region 10 (Asia and Pacific) Executive Committee. He was the *Founder* and *President* of the Mechatronics and Robotics Society of the Philippines.

Dr. Dadios Published and Edited 4 Books on Fuzzy Logic. He had *published more than 200 technical papers* in Journals and Conference Proceedings majority of which are in IEEE transactions and technical sponsored conferences. He contributed chapters in Books published by CRC Press LLC, USA and InTech Croatia. He has been a consultant for Robotics and Intelligent Systems in the Philippine government and private corporations.

Currently, Dr. Dadios is a *University Fellow* at the De La Salle University and holds the highest faculty rank of *Full Professor 10*. He is a Senior Member of the Institute of Electrical and Electronics Engineer (IEEE). His research interests are: Robotics,

Mechatronics, Automation, Intelligent Systems, Neural Networks, Fuzzy Logic, Genetic Algorithms, Evolutionary Computation and IT.

Chun-mei Su

Su, Chun-Mei is a Ph.D candidate in Management at Business Administration Department, National Central University, Taiwan. Her major is in strategic management and supply chain management.

Der-Juinn Horng

Horng D.J. is an associate professor at Business Administration Department, National Central University, Taiwan. His major is in strategic management.

Ming-Lang Tseng

Tseng, Ming-Lang (Ph.D) was a research fellow at Shenyang Institute of Applied Ecology in Chinese Academy of Sciences, China, in 2012-2013 and Visiting professor at supply chain center in the University of Derby, United Kingdom in 2015. Presently, he is a full Professor of department of business administration in Lunghwa University of Science & Technology, Taiwan

In academic society services, currently, he is an Editorial Board Member of Applied Soft Computing (SCI), Editorial Review Board Member of Industrial Management and Data System (SCI), and Guest Editors of Resources, Conservation and Recycling Journal (SCI), Journal of Cleaner Production (SCI), International Journal of Production Economics (SCI) and International Journal of Production Research (SCI) etc. He also contributes himself as vice president of

International Society for Business Innovation & Technology Management (ISBITM); Trustee member of Asia Pacific Industrial Engineering and Management Society (APIEMS), Chair of Asia Pacific Business Innovation & Technology Management Society (APIEMS) and as a reviewer of several international journals (Operations and supply chain management). H-index (Scopus) :20; Google index: 27

Anthony SF Chiu

Chiu, SF Anthony is a Professor at Industrial Engineering department, De La Salle University, Manila, Philippines. He is also a global expert in University Nation. He is currently the president of International society for business innovation and technology. This society holds conferences in the region.

Michael Angelo B. Promentilla

Michael Angelo B. Promentilla is a Professor of Chemical Engineering and head of the Waste and Chemicals Management Unit of the Centre for Engineering and Sustainable Development Research (CESDR) at De La Salle University (DLSU) . His research interests vary from a wide spectrum of application of decision modeling and risk analysis to environmental and energy systems, as well as, to the design and characterization of sustainable engineering materials. Dr. Promentilla received his BS in chemical engineering (cum laude) and MS in chemical engineering from University of the Philippines Los Banos (UPLB) and Diliman (UPD), respectively. He received his doctorate degree in socio-environmental engineering from Hokkaido University, Japan for developing a multi-criteria decision making method for contaminated

sites management. He was also awarded for a two-year postdoctoral fellowship and research grant at Hokkaido University by the Japan Society for the Promotion of Science (JSPS) to conduct study on the application of X-ray microtomography to characterize the microstructure of cement-based materials. Results of his research activities and accomplishments are published in peer-reviewed and ISI-listed journals, and are also presented in both local and international conferences, workshops, and symposia. He currently has more than 30 publications indexed in Scopus with an h-index of 8. He was recognized as one of the Outstanding Young Scientists of 2013 in the field of socio-environmental engineering by the Philippine National Academy of Science and Technology (NAST), and also the recipient of multiple scientific awards from the Commission on Higher Education (CHED) and the Japan Concrete Institute (JCI).

Alexander Abad

Alexander C. Abad is a graduate of BS Electronics and Communications Engineering at St. Louis University- Baguio City. He finished his MS in Electronics and Communications Engineering at De La Salle University - Manila and currently taking up his PhD in ECE at DLSU. His field of interest includes robotics, machine intelligence, machine vision, mixed-signal electronics and IC design.

Elmer Magsino

Elmer R. Magsino earned his Bachelor of Science in Electronics and Communications Engineering and Master of Science in Electrical Engineering at the University of the Philippines ñ Diliman, Philippines in 2002 and 2006 respectively. His research

interests concern linear and non-linear control systems, signal processing and Mechatronics. He is currently an Assistant Professor at the De La Salle University in Manila Philippines and is currently pursuing his PhD in Electronics and Information Engineering. He is a member of the Science and Engineering Institute and International Association of Engineers.

Mark Lorenze Torregoza

Mark Lorenze Torregoza finished his Bachelor of Science in Electronics and Communications Engineering at Polytechnic University of the Philippines year 2008 and passed the corresponding licensure exam the same year. In 2012 he graduated Master of Science of the same course at De La Salle University Manila and is currently taking his PhD in the same university of the same course. He worked as a network engineer for a telecommunications company early in his career and now a member of the faculty of the ECE department of DLSU-Manila. His research interest is mainly on computer networks, routing and switching algorithms.

Andres Philip Mayol

Mr. Andres Philip Mayol is a graduate student and a research assistant of the Mechanical Engineering Department at De La Salle University, Manila, Philippines. He is a Magsaysay Young Engineers and Technologist awardee given by the National Academy of Science and Technology, Department of Science and Technology Philippines. His research interest are photobioreactor design, Computational fluid dynamics, and algal biofuels and bioproducts. He has published 4 Scopus-indexed papers in the field of environment and energy engineering.

Aristotle Ubando

Dr. Aristotle T. Ubando is an associate professor and a research fellow of the Mechanical Engineering Department at De La Salle University, Manila, Philippines. He is a recipient of the Fulbright Philippine Agriculture Scholarship Program for Doctoral Dissertation Award at the University of Arizona addressing climate change and energy production through algal systems in 2013. His research interests are optimization of energy systems, life-cycle assessment, and processing of algal biofuels and bioproducts. He has published more than 20 Scopus-indexed papers in the field of environment and energy engineering with an h-index of 4. He currently works on multiple projects in improving the agriculture and aquaculture industry in the Philippines.

Alvin B. Culaba

Dr. Alvin B. Culaba is a University fellow, and full professor of the Mechanical Engineering Department at De La Salle University, Manila, Philippines. He is also an Academician of the National Academy of Science and Technology, Department of Science and Technology, Philippines. His areas of specialization include: energy technology and management, life cycle assessment, management of technology, manufacturing and environmental system engineering, and cleaner production technologies. He has published more than 40 Scopus-indexed papers in the field of environment and energy engineering with an h-index of 15.

Joel L. Cuello

Dr. Joel Cuello is a professor in the Department of Agricultural and Biosystems Engineering at the University of Arizona, Tucson. He has been teaching and conducting research there since 1995. His research expertise focuses on algae biodiesel and hydrogen production, algae photobioreactor design and scale up, algae CO₂ capture, algae lighting strategies, algae alternative nutrient media, wastewater use for algae production, chemical production from plant cell cultures, and design of hybrid solar and electric lighting systems for plant applications. Dr. Cuello's research studies have received funding from NAS, DOE, DARPA, NSF and USDA, among others. He has over 70 scopus-indexed journal publications with an h-index of 10, nine book chapters, and has been invited numerous times as keynote or guest speaker at institutions and conferences worldwide.

Alberto Bañacia

Alberto S. Bañacia is currently an assistant professor in the Department of Electrical & Electronics Engineering at the University of San Carlos in Cebu City, Philippines where he also serves as the Communications and Broadcast Engineering Laboratory head. He received his BSc in Electronics and Communications Engineering from the same university in 1990 and his Master of Information Engineering from Mie University, Japan, in 2004. He is currently working on cognitive radio and TV white space as his PhD dissertation topic.

A professional Electronics engineer (PECE), he is an active member of the Institute of Electronics Engineers of the Philippines (IECEP) Cebu chapter and a member of the different societies affiliated

with the Institute of Electrical and Electronics Engineers (IEEE) namely IEEE Signal Processing Society, IEEE Communications Society and IEEE Education Society.

His research interests are in the areas of image processing (face detection, tracking, and recognition), modulation, source and channel coding, wireless communications systems on software-defined radio platforms, cognitive radio, and TV white space.

GUIDELINES FOR CONTRIBUTORS

1. The *Journal on Computational Innovations and Engineering Applications* (JCIEA) aims to promote the development of new and creative ideas on the use of technology in solving problems in the field of computational applications, computational intelligence, electronics and information and communications technology (ICT), manufacturing engineering, energy and environment, robotics, control and automation, and all their related fields. Manuscript submissions should, therefore, be in pursuit of the same goal and within the related fields.
2. JCIEA only accepts manuscripts written in English. The responsibility for copyediting manuscripts, as well as obtaining reproduction permissions for the use of graphics and other materials from their references, will fall on the author.
3. Authors must also remember to cite all references and ensure that their paper submission has not been previously published or is undergoing peer review for another publication.
4. Manuscripts should include a unique title, an abstract, some keywords, an introduction and discussion of the study, a presentation and discussion of results, and a conclusion. Authors may also include an acknowledgement of funding organizations or consultants, if needed.
5. Manuscripts may be sent to **jciea.dlsu@gmail.com** or **jciea@dlsu.edu.ph** as either an MS Word file (*.doc or *.docx) or a LaTeX file (*.tex), including its supporting files.
6. Manuscripts in either file format should have the following features:
 - Single-spaced, two-column format with 1-inch margin on all sides on letter-sized template
 - Font to be used is Times New Roman, size 11
 - Graphs (*.eps, *.svg), tables (*.csv), and images (*.jpg, *.png) should be saved and sent apart from the MS Word file.
 - Citations and references should be submitted in IEEE or APA format. Submission of these references in a BibTeX format is preferred.
7. Manuscript should be eight to twelve (8–12) pages long, including all figures, tables, and references. Manuscripts exceeding the 12-page limit will require permissions from the editors.
8. Authors must include their full names and affiliations in the manuscript. They may include a 150- to 200-word biography to be included in the back portion of the journal.

*Journal of Computational Innovations
and Engineering Applications*

SEMIANNUAL ♦ PEER-REVIEWED ♦ ONLINE ACCESS

CALL FOR PAPERS

in

Computational Applications

Computational Intelligence

**Electronics and Information and
Communications Technology (ICT)**

Manufacturing Engineering

Energy and Environment

Robotics, Control, and Automation

For inquiries and paper submissions, email us at jciea@dlsu.edu.ph
or visit us at www.dlsu.edu.ph/offices/publishing-house/journals.asp