



CONGRESS PROCEEDINGS

3rd DLSU Senior High School Research Congress
*Reframing Possibilities Through Research
and Innovation for the Better Normal*

April 29 - 30, 2021

De La Salle University
Taft Avenue, Manila

MESSAGE

DLSU PRESIDENT

Br. Raymundo B. Suplido FSC
De La Salle University President

To the esteemed Lasallian students, mentors, and guests, welcome to the 3rd Senior High School Research Congress. Despite the challenges that our society is facing today at the advent of both natural and health calamities, I am deeply honored to welcome all of you here as we continue producing relevant research ideas to realize a better normal.

The COVID-19 pandemic has significantly changed the way we live. It is an exogenous shock whose drastic effects were not predicted until it became too late. While the pandemic affected most of us negatively, it cannot be denied that it also opened up opportunities to learn. For one, it highlighted the benefits of having a vital healthcare infrastructure. It also showed the importance of looking at the social and political dimensions of a health issue. Finally, it exhibited how different art forms could help us cope with distress and grief. In general, the pandemic hopefully made us realize how problems need to be treated in a multi-faceted manner. It made us realize a volatile, uncertain, complex, and ambiguous (VUCA) contemporary society - one that requires not just resilient systems, but also future-proof. Perhaps, the biggest challenge for young researchers like you is to produce novel ideas that would usher in a paradigm shift from our usual, comfortable practices.

The first and second editions have proven themselves to be an avenue for topnotch research endeavors of Senior High School students. In a time of global crisis, research has never been more critical. That is why this year, despite various constraints, DLSU will have its 3rd SHS Research Congress with the theme "Reframing Possibilities Through Research and Innovation for the Better Normal." This event will serve as an avenue for young scholars to communicate with each other and present their visions of the future.

DLSU has always strived to be a university that helps in nation-building through bridging faith and scholarship through research. We hope to receive papers that engage with the problems encountered in the "old normal" and those that envision a "better normal."

ANIMO LA SALLE!

MESSAGE CHANCELLOR

Br. Bernard S. Oca FSC
De La Salle University Chancellor

A warm Lasallian greetings to our young researchers and research mentors from all over the Philippines, and in Japan!

2020 has made us realize all the more how volatile, uncertain, complex, and ambiguous our society has become. It has made us realize that our present systems and mechanisms at work, in school, and in any other aspects of our life may not be ready for abrupt disruption. Indeed, if we are to survive the threats of the contemporary society, we need to future-proof our practices. Consequently, future-proofing is easier said than done.

The VUCA world is forcefully advancing and it brings with it tremendous challenges to our society. It carries with it megaproblems of poverty, conflict, full-automation and degradation, among others. We are at a critical standpoint where we have to make decisions about the path that we want our world to take – instability or sustainability. Whatever we do now impacts the future. However, this future will not serve my generation but the generation of these bright young minds present today. Thus, it is essential to involve them in our pursuit of ways to solve the world’s biggest problems. The youth of today, provided they get guided and mentored properly, is bigger than these megaproblems.

What you have witnessed in the past two days serves as a testimony of how the youth takes part in recreating a better version of our society. Future-proofing, after all, are decisions made from creative pursuits that marry the arts and sciences. I am in high hopes that underpinning all the researches presented in this Congress is the desire to extend academic worthiness to real-world impact that would inspire solutions to our interlinked global problems. Research gives us the power to create any version of that “better normal”.

I am challenging you to continue asking the right questions and discovering new ways of answering them in these uncertain times. Do not lose your intellectual creativity. Let us uphold the Lasallian commitment of bridging faith and scholarship for a better normal.

ANIMO LA SALLE!

THE 3RD DE LA SALLE UNIVERSITY SENIOR HIGH SCHOOL (DLSU SHS) RESEARCH CONGRESS

The DLSU SHS Research Congress is an annual gathering of research mentors, and senior high school students as they bring with them research-based ideas, concepts, products, and art performances and exhibitions from their own capstone projects. It is a vision conceived by DLSU SHS' commitment to making a dent in society by involving the students in knowledge creation. In line with the University's vision- mission of bridging faith and scholarship, the Congress highlights the essential role of nurturing a culture of research through the production and dissemination of innovative knowledge for human development and social transformation.

Featuring 58 paper and poster presentations, 15 business concepts, and five creative exhibits and performances, the 1st DLSU SHS Research Congress served as a platform to showcase research diversity. It was attended by around 2 000 students, researchers, and teachers from 36 schools across the country. The success of the first congress paved the way for the conception of the 2nd DLSU SHS Research Congress, which focused on scientific and creative research pursuits in line with the advent of the Fourth Industrial Revolution. Around 1 000 proposals were received from 16 confirmed schools in the country. However, because of unforeseen calamities such as the Taal Volcano Eruption and COVID-19 Pandemic, the congress was cancelled. Nevertheless, a Book of Abstracts for accepted proposals including 123 paper and poster presentations, 20 business concepts, and 36 creative exhibits and performances was released to recognize the promising featured research outputs for the year.

Recognizing the challenges of a volatile, uncertain, complex, and ambiguous (VUCA) society characterized by both disruptions and opportunities, the 3rd DLSU SHS Research Congress takes on the digital platform to showcase research ideas that would potentially help society navigate through all the uncertainties of the contemporary world. Natural and man-made calamities, and health hazards (i.e. COVID-19 Pandemic) disrupt conventional processes and practices. Amidst the recent happenings in the country, it is crucial to adopt innovative ways to lead disruption-proof societies through research. With the theme, "Reframing Possibilities through Research and Innovation for the Better Normal," the 3rd DLSU SHS Research Congress welcomes daring research pursuits that adopt unconventional concepts and methodologies in producing researches relevant to realizing a better normal.

THE CONGRESS EVENTS

A. Paper Presentation

The Paper Presentation will showcase research concepts, collaborations, innovations, and products of various strands and tracks through an interactive virtual presentation.

B. Poster Presentation

The Poster Presentation is an exhibition of research concepts, collaborations, innovations, and products of various strands and tracks through a virtual display of research posters. This exhibit will particularly show the relevance and contribution of the presenters' research work in their chosen discipline.

C. Business Concept Bazaar

The Business Concept Bazaar will provide an opportunity for future businessmen and businesswomen to demonstrate their entrepreneurial skills and showcase their innovative products. The business concepts shall be supported by sound business plans that promote product sustainability and social responsibility.

D. Art Performances and Exhibitions

The Art Performances and Exhibitions will showcase research-based creative outputs of young artists. These art performances and exhibitions reflect insightful messages through various art expressions that are creative, innovative, and socially relevant.

E. Teacher Training

The Teacher Training is designed to be a teaching development program where teachers are given an opportunity to immerse into a discourse on integrating research skills in pedagogy.

TABLE OF CONTENTS

Message - DLSU President	I
Message - Chancellor	II
THE 3RD DE LA SALLE UNIVERSITY SENIOR HIGH SCHOOL (DLSU SHS) RESEARCH CONGRESS	III
Congress Events	IV
Table of contents	V
Paper Presentation	
Teenagers' Utilization of Social Media in Taking Care of their Mental Health During the COVID-19 Pandemic: A Phenomenological Study	2
The Efficacy of BRafeNHS Student Representative Coordinating Council A.Y. 2020-2021	7
Two Roads that (should) Converge: Perceived Effectiveness of Synchronous and Asynchronous Learning by Senior High School Students at José Rizal University	13
Students' Preferences on the Kinds of Online Learning Resources	18
Study Habits of LORMA Senior High School Students Engaged in Online Learning	23
The Perceptions of Incoming College Students from One of the Universities of the South On the Use of Biomimicry as A Method in The Field of Engineering	28
Aspects Contributing to the Underemployment of the Top 3 Fields of Engineering in Las Piñas City, and Muntinlupa City	34
The Benefits of Taking Math and Science Enrichment to the STEM Strand in Senior High School	40
Exploring the Viability of Augmented Reality as a Supplementary Material for Learning Cell Biology and Photosynthesis for Grade 12 Students	46
Feasibility of Using Phone and Web Cameras to Detect Micro-Expressions for Lie Detection	50
Developing a Prototype for a Microcontroller-Based Coin-Counting Machine	54

COVIDetect: A Desktop Application as a Diagnostic Tool for Novel Coronavirus (COVID-19) Pneumonia in Chest X-ray Images Using Convolutional Neural Network	59
Design and Analysis of a Myoelectric Arm Prosthesis for Transradial Amputees working as Auto-Mechanics	64
Prosthetic Arm for Amputees: Labor Job in Manufacturing Factories	69
Comparative Analysis between the Shinyei PPD42NS and Plantower PMS7003 Low-Cost Air Quality Sensors	75
FoFi: The Development of a Handheld Monitoring Device in Predicting Naturally Occuring Forest Fires	80
Electronic Cartero Machine (ECM): A RFID-Based One-Way SMS-Sending Kiosk	86
Conceptualization of a Surveillance Drone for Aquatic Expeditions	92
The Rise of Dough: Mid-Pandemic Baked Desserts Startups	99
Exploring the Startup Costs and Profit of Bitcoin Mining in Urban Philippines	104
Karanasan ng mga Piling Negosyante ng Damit Pambabae sa Paggamit ng Estratehiyang Green Marketing	109
Externalizing Behaviors and Family Influences on Filipino Urban Adolescents: A Social Learning Theory Approach	115
Behaviors as Predictors of Reinforcement: Investigating Parent's Psychological Antecedent and Parental Engagement Mechanisms in Distance Learning	121
Effects of Personality on Social Status: A Study on Perceived Social Dominance Among Adolescent Single Sex Social Groups	128
Pre-Medicine Program as a Factor Influencing Residency Specialization Options of Medicine Students of University of Perpetual Help System DALTA-Las Piñas Campus	133
A Review on the Application of Voltammetry in the Determination of Activity of Vitamins and Antioxidants in Fruit Juices	138
Spatial Mapping and Modeling of Reported Dengue Incidences in Luzon	144
The Integration and Appraisal of Electronic Medical Records (EMR) in Cotabato Regional and Medical Center	150
A Systematic Review on the Efficacy of Common Antacid Components	154
A Systematic Review on the Effects of L-theanine and Caffeine Combination on Human Mood and Cognition	160

Wound Healing Activity of Herbal Ointment Containing the Ethanolic Leaf Extract of Gumamela (<i>Hibiscus rosa-sinensis</i>)	166
Eat, Train, Operate, Repeat: Ang Karanasan ng mga Orthopedic Ironman Triathletes sa kanilang Isport at Propesyon	172
Ang mga Coping Mechanisms at Motibasyon ng mga Medikal na Frontliners hinggil sa Stress at Burnout sa Panahon ng Pandemya 2021	178
Mango (<i>Mangifera indica</i>) Bark Aqueous Extract as Antimicrobial Spray	183
A Review on the Antioxidant Activity of Select Philippine Fruits and Wines	187
Effects of Different Drying Methods on Extractable Phenolic Compounds from Turkey Berry (<i>Solanum torvum</i>) Leaves	192
The Role of Dreams in the Assessment and Analysis of Mental Health Conditions from the Perspective of Mental Health Practitioners	199
WEARING CUT SLEEVES: Unpacking Narratives of Coming Out by Chinese Filipino LGBTQIA+	203
“I saw the sign”: Extent of Use of Filipino Sign Language and its Impact on Interpersonal Relationships in the Workplace among Deaf employees	208
Lived Experiences of Filipinas in Adhering to the Beauty Standards in TikTok	214
Internet Addiction Among Students of a Private University in Manila, Philippines: Positional Variations and Psychosocial Wellbeing Outcomes	220
The Effects of Church Service on the Identity Formation of Baptized Roman Catholic Gay Youth	224
Determinants of Sexual Literacy of Senior High School Students in De La Salle University-Manila	229
Listening to Silence: An Insight into the Lives of the Deaf in Baguio City	235
Do apples fall not far from the tree?: An exploratory research on the influence of parents to their children's attitudes toward the LGBTQ+ community	241
Tactics & Tenacity: The Effects of a Fantasy-Based Tabletop Role-Playing Game on the Decision-Making Skills of Young Adults	246
Drowning Screens: Social Media Experience and the Emotional Well-Being of Filipino Adolescents	251

Ethnocultural Analysis on Different Practices of Bihog Tribe (Agta) on Childbearing	256
An Ethnocultural Study on the Medical Practices of 'Magtatambal' in Tagkawayan, Quezon	260
Feasibility of Unwaxed and Waxed Banana (<i>Musa acuminata</i> x <i>balbisiana</i>) Pseudostem Fibers as Alternative Dental Floss Material	264
Hybrid Pigments Based on Anthocyanins and Clay Minerals: A Mini Review	269
Meta-Analysis on the Dissolution of Bamboo (<i>Bambusa</i>) Cellulose using NaOH/urea Aqueous Solution	274
Development of Generalized Correlation for Electrical Conductivity Prediction of Pure Ionic Liquid	279
A Preliminary Study on the Chiral Vector Approach in Determining the Optimum Structure of Carbon Nanotubes and its Correlation to the Chemical Potential Energy Using Avogadro	285
The Effect of Coconut Fiber as Concrete Reinforcement on Abrasion Resistance and Water Permeability	292
Analyzing the Depictions of Queer Struggles in Selected Asian BL Series	297
Edutainment: Pagsusuri sa mga Gampanin, Katangian, Arketipo at Simbolismong Nakikita sa Pagganap ng mga Piling Karakter na Selyula sa Japanese Anime Na “Cells At Work!”	302
Women on the Margins: A Case Study on the National Federation of Peasant Women in the Philippines (AMIHAN)	308
Paghilom: A Narrative Analysis of the Healing testimonials of The Mary, Mediatrix of All Grace Devotees in Facebook Groups.	312
Calling in Call-out Culture: An Analysis on Call-out Culture and its influence on Filipino Twitter	317
Pagdalumat sa Sosyo-kultural at Pangkapaligirang Aspekto ng Uhayan Festival Gamit ang Likas-kayang Balangkas ng Pistang Pamana Pistang Naaayon	323
Kamalayan, Pag-aangkop, at Pagpapatuloy: Pagbalangkas sa Diwa at Danas ng mga Comedy Bar Performers sa Panahon ng Pandemya Gamit ang Konsepto ng “Loob” ni Fr. Albert Alejo	328
Mga Proseso at Naratibo: Isang Preliminaryong Pagtatala sa Magnetic Folk Healing Bilang Katutubong Pamamaraan ng Pagpapagaling sa Barangay Kinabuhayan at Sta. Lucia, Dolores, Quezon	334

From Pre-Alpha to Freestyle: Figure Skating Through the Lens of Filipino Figure Skaters	340
Forecasting Road Traffic Accidents in the Socioeconomic Context	344
Perspective on Employment Opportunities of People with Disabilities in San Gabriel, La Union	352
Senior High School Students' Political Participation in the Emerging Social Issues	357
Modernized Tradition: Transformation of Public Transport	362
Ur Next GF: Urine as Next Generation Fertilizer with Meat and Bone Meal Applied on <i>Vigna radiata</i> (Monggo plant)	368
Development of a Cost-effective Microbial Fuel Cell (CEMFC) to Generate Electricity from Carbohydrate Food Waste	374
A Review on the Potential and Efficacy of Plant-Based Mosquito Repellents Against DEET-Based Mosquito Repellents	380
Solar Power Integration in Water (H ₂ O) Distillation (SPIN-HD)	386
A Systematic Approach for the Paper Review on the Utilization of Citrus Fruit Waste in the Philippines	392
Effervescent Water Coagulant from <i>Citrofortunella Microcarpa</i> Scraps for Water Treatment	399
Survey on Traditional Mangrove Crab Identification Methods of Filipino Fishermen	405
Fish waste as a resource: An approach to lessen the impact of improper solid waste management in the Philippines	411
Paper Review for Application of Thermally Treated Eggshell Waste: A Systematic Approach	415
Effect of Different Amounts of Volcanic Ash from the Taal Volcano Eruption to the Growth of <i>Ocimum basilicum</i> (Basil)	421
On the Effects of N-P-K Fertilizer to the Electricity Generated by <i>Aloe barbadensis miller</i>	426
A Life Cycle Assessment of Disposable Medical Masks and its Impacts Towards the Environment in the Context of the COVID-19 Pandemic	431
A Systematic Review on Water Hyacinth (<i>Eichhornia crassipes</i>) as a Biosorbent of Cadmium	438
An Experimental Study on Sugarcane (<i>Saccharum officinarum</i>) Bagasse and Corn (<i>Zea mays</i> L.) cob as a Potential Bio-adsorbent for Used Engine Oil	443

Systematic Mapping on Adsorption Studies Using Spent Coffee Grounds	449
Assessing the Technological Maturity of Vegetable Protein-Based Biodegradable Packaging Material Production	456
Oil Adsorption Capacity of Mahogany (<i>Swietenia macrophylla</i>) Fruit Shells in Varying Particle Sizes	461
Comparative Analysis of Colorfastness of Extracted Pigment from Kangkong (<i>Ipomoea aquatica</i>) with Varied Alcohol Solutions	467
Advantages and Disadvantages of Traditional Abaca, Genetically Modified Abaca, and Cross Hybrid Abaca	471
Zoologists on the Move: Mga Karanasan, Hamon, at Motibasyon ng mga Zoologists edad 25-50 sa Metro Manila	477
The Effect of Spent Coffee Grounds to the Growth of <i>Solanum lycopersicum</i> (Tomato)	483
Bibliometric Analysis on Biosensors and their Applications in Agriculture	488
Studies on the Morphological and Mechanical Properties of Oil Palm Empty Fruit Bunch-derived Nanocellulose for Supercapacitor Applications	493
The Potential Electrospinnability and Filtration Capabilities of Pea-Protein Isolate/Polyvinyl Alcohol Air Filter Nanofabrics: A Systematic Review	499
Characterizing Perceptions on Factors Associated with Cycling Behavior in the “New Normal”	506
Mung beans (<i>Vigna radiata</i>) as a Main Component in Bioplastic Synthesis: An Exploratory Research	513
A Prototype of D.I.Y. Landslide Alarm	519
Terpenes Properties as Biopesticides	526
Agaricales Production: A Systematic Review on its Representative Species’ Cultivation Process and Substrate Influence	532
Willful Ignorance, Self-Deception, and the Motivation Condition– A Reply to M. Glowicki (2018)	539
An Ethical Inquiry to Personhood as the Standard for Sexbot Ownership: A Response to S. Petersen	543
An Ethical Assessment of Philippine Laws on National Security through Deontological Ethics	547

Poster Presentation

Online Distance Learning in Baras-Pinugay: Grade 11 HUMSS & TVL Students' Challenges and Opportunities	552
The Effect of Using Exoskeleton of Blue Crab (<i>Callinectes sapidus</i>) as a Dietary Calcium Source on the Egg Characteristics of Layer Hens (<i>Gallus gallus domesticus</i>)	557
COVID-19 Swab Test Experiences of Employees As Required By Their Employers	563
A Comparative Analysis on the Mechanical Properties of Abaca, Banana, and Coir Fiber Reinforced Polymer Rebars	568
Utilizing <i>Cucurbita moschata</i> Duch. (Winter Squash) Fruit Peels as a Viable Component of Paper	574
Design and Analysis of a Face Mask Alternative	580
Sino malaya?: Melodrama and the integration of contemporary social issues in Philippine independent films	584
Perceptions of Parents' Attitudes towards Activism and its Impacts on the Political Behavior of Undergraduate Student Activists	589
Nationalism and Social Advocacy amongst select Generation Z University Students in Metro Manila	594
A Comparative Study on the Effects of Size and Sources or Traceability on the Price of Identified Fish Species Sold at Muñoz Market, Quezon City	600
Potential Use of Morphological Characteristics in Evaluating Natural Variation of "Barako" Seedlings	606
A Systematic Review on Biosorption of Copper (II) ions in using Water Hyacinth as a Biomass	611
Designing a Tensegrity Form of an Outdoor Hydroponic System Utilizing Bamboo (<i>Bambusoideae</i>) and Abaca Fiber (<i>Musa textilis</i>)	616
Efficiency of Renewable Energy for Reverse Osmosis Desalination Systems in Asian Developing Countries: A Systematic Review	621
The Effect of Mango Peel on the Growth of Okra (<i>Abelmoschus esculentus</i>)	626
The Design Development of Solar Box Cooker on Wheels as an Alternative for Philippine Rural Households	630

Business Concept Bazaar

VARAYTI	638
---------	-----

HO TSIA	643
EUNOIA	653
FILO: For and by the Filipinos	658
BEYOND CLOTHING	664
Bahay ni Lola: Traditional and Fusion Filipino Cuisine	673
HIRAYA	685
Assessing the Marketability of BEU as a Loungewear Brand Producing Ethically-Made and Gender-Inclusive Clothing in the Philippines	691
Kargaen	701
Unfurl Official	709

Art Performances and Exhibition

THE SIGNIFICANT IMPACT: WHAT MAKES A LIFE WORTH LIVING	716
Born This Way: A Short Story	717
Star For a Day: A One-act Play	719
Tabi, tabi po: Filipino Mythologies and Superstitions as Motifs in a One-act Play Collection Surrounding Contemporary Society	721
Dancing Identities: Deconstructing the concept of “Finding the Filipino” in the context of the Dance Culture in Metro Manila	725
BATEVATAN of the South: An Architectural Duplex Housing Plan Concept	729
AnimoX: A Virtual Campus Tour of De La Salle University - Integrated School Application Prototype Development	731
Valor: An Integration of Character Design in Creative Wears for Icons in the time of Pandemic	735
Home of Hope: Enhancing Interior Spaces to Cultivate a Sense of Belonging and Cultural Identity Within an Orphanage	738
Prepared for Nature’s Unknown: An Architectural Solution for Enhancing Safety and Comfort in Homes in the Philippines	740
Sa Likod ng Paghahabi: A picture book based on the Lumad communities’ narratives regarding the prevailing conflicts against their human rights	743

What Lies Within: Designing a 2D Pixel Video Game to depict changes in social behavior and physical state for students diagnosed with depression during the COVID-19 Pandemic in the Philippines.	747
Bahala na!: And 9 Other Ways to Be Toxic: A Graphically Illustrated Zine Depicting Toxic Filipino Mentality	750
Pabalot: Digitally Illustrated Stickers on Social Media and Its Influences on Colorism in the Philippines	753
COLMO: A Children’s Video Game Introducing the Concept of Emotions Through Visuals	756
Forked: A Comic Book Depicting the Struggles of Choosing Between Pursuing One’s Dream versus Parental Choices	760
Bahagharing Dagat: A Series of Graphic Illustrations Depicting Plastic Pollution Situation of Philippine Marine Life During the Pandemic	762
Kalalaki Mong Tao: A Series of Digital Illustrations Focused on Fragile Masculinity in the Philippine Context	764
This is Home: A Digital Animation Telling A Story of A Filipino Immigrant Child Returning Home	768
Unsaid Woes: The Lives of Young Women Under the Constraint of Rape Culture	770
Lawin at Sisiw: A Role-playing Game Solving the Filipino Disunity Caused By the Great Cultural Divide Through Pakikipagkapwa	774
Sa Araw ng Pag-ani: A Short Film on Representations of Hope in Media Inciting Climate Activism	778
Ang Kulungan sa Aking Kinagisnan: A Play With Music to Showcase Oppression of Freedom of Speech in the Arrest of the Protestors of Sitio San Roque, Barangay Pag-asa in Quezon City During April 1 of the COVID-19 Pandemic Metro Manila Lockdown	781
Tribulation, The Adversities of Women in the Past and the Present: A Melodrama of Gender Inequality Parallels Between Selected Classic Plays and 21st Century Discrimination Case Studies on Women	783
A Folklore Tale - Art Direction in Film: Applying Elements of Art Direction to Film Expressed as a Diorama	786
Three-Ring Circus: Images of Income Inequality and Class Conflict in the Philippines Through a Mixed Media Painting Collection	788
3rd DLSU Research Congress Committee	791
Editorial Board/ Publications Committee	791



PAPER PRESENTATION



Teenagers’ Utilization of Social Media in Taking Care of their Mental Health During the COVID-19 Pandemic: A Phenomenological Study

Ralph Anthony C. Bautista, Justin Andrei P. Ibe, Julio Amir D.R. Tampis
and, Aaron Shane N. Warain
St. Edward School, General Trias City, Cavite

Janeson M. Miranda
*Research Adviser
De La Salle University*

Abstract: With the ongoing pandemic, mental health concerns have been observed to be on the rise. Lockdowns have prompted many, especially the youth, to primarily use social media for communication and for addressing their mental health issues. However, past studies merely investigated the positive and negative effects of social media on mental health in general; there have been scarce resources that detail how these platforms are used for mental health concerns during the pandemic, particularly among teenagers in the Philippine context. Hence, the study aims to examine the experiences of teenagers in using social media platforms in dealing with their mental health issues during the pandemic. Employing phenomenology, ten senior high school teenagers were interviewed through Zoom to determine how and why social media platforms are used in relation to mental health. Thematic analysis was employed to look for emerging themes. The results showed that platforms namely Twitter and Messenger were popularly used by teenagers. Such platforms were found to be used with limitations due to the fear of familial judgment and fear of disingenuous reactions. Also, it was found that the reasons for such social media usage were (a) to seek other modes of communication, (b) to look for a source of entertainment, (c) to express emotions, (d) to spread positivity, and (e) to raise awareness about mental health. With these findings, it can be concluded that social media does have a monumental role in sustaining or improving teenagers’ mental health. Thus, recommendations for future studies have been made.

Key Words: social media; mental health; pandemic; effects; platforms

1. INTRODUCTION

The COVID-19 pandemic has forced many countries to implement lockdowns. These lockdowns have led to short or long-term psychological and mental health issues (Evans, 2021), especially among young people (University of Surrey, 2021). Hence, the use of social media and mental health during the pandemic have been found to be correlated (Zhao & Zhou, 2020). Nonetheless, there still has been a huge portion of blame placed towards social media in the context of mental wellness although the findings are still fragmentary.

Numerous studies such as Rasmussen et al. (2020) speculate that there is an indirect relationship between social media use and mental health issues among emerging adults since they encounter difficulties in coping with emotional and perceived stress. There are also significantly higher tendencies for internet addiction among depressive patients (Dieris-Hirche, et al. 2017). Likewise, social media have been found to be negative since cyberbullying is

often connected to social media usage (Glazzard & Stones, 2019).

While some prior studies have centered on negative social media effects on mental health, some researchers claim otherwise. Hardy and Castonguay (2018) reported that individuals aged 18-19 felt low levels of anxiety when exposed to social media. Bekalu et al. (2019) also underscored that social media can be a positive tool after linking social media usage and self-rated health.

While there have been varied findings in the literature on the relationship of social media and mental health, studies that attempted to explore how social media is used as a platform by teenagers to address mental health issues are limited. Majority of the previous studies merely focused on the general negative or positive impact of social media on individuals’ mental health. In addition, it seems that there have been scant investigations on how social media platforms are used by teenagers in taking care of their mental health during the pandemic,



specifically in the Philippine context. Lastly, the previous investigations primarily utilized quantitative perspectives; and so the need to use a qualitative lens in investigating the phenomenon has become apparent. Addressing these gaps in the literature, we employed a phenomenological research design; and thus answer the following research questions:

1. What social media platforms do senior high school teenagers use in taking care of their mental health during the COVID-19 pandemic?
2. How do these students utilize these platforms in assistance to their mental health?
3. Why are these said platforms used by these students for mental health purposes?

2. METHODOLOGY

2.1 Data Collection, Sampling, and Procedure

Ten participants aged 17-18 years old studying in senior high schools in the Philippines participated in the study. This is the desired number of participants in a phenomenological study to achieve data saturation (Boyd, 2001, as cited in Groenewald, 2004). We purposefully selected the participants by setting the following criteria: a) they have experienced or are experiencing mental health concerns, b) they have used or are using social media platforms for mental health issues during the pandemic, c) they must be in senior high schools in the Philippines. In addition, we followed most of Morrow's (2005) principles of trustworthiness such as the congruence of philosophical assumptions with the research questions, inclusion of intellectual heritage in the research design, describing the rationale for reflexivity, and selecting participants for information richness. An Ethics Clearance Form and Parental Consent Form were also put to use to ensure that the rights and privacy of the respondents were upheld to the fullest.

Semi-structured interviews were utilized and were conducted via Zoom, given the ongoing limitations due to the pandemic. The open-ended questions were checked by experts to have a qualitative face validity.

2.2 Research Design and Data Analysis

We employed phenomenological research design in our study as we sought to determine how and why the participants used social media platforms individually, especially during the time of the pandemic. The primary purposes of phenomenological research are to derive substance from individuals' personal interpretations of experiences and feelings,

and to construct in-depth descriptions of the phenomenon (Lester, 1999). Since we would like to investigate the experience of the teenagers in using these platforms for mental health, phenomenology provides a more accurate depiction of how truly these teenagers put them to use for the said purpose.

We analyzed the data gathered in the interviews using a thematic analysis, specifically observing the six steps of thematic analysis that involve data familiarization, generating simple codes, searching for themes, reviewing themes, defining themes, and the write-up (Braun and Clarke 2006, as cited in Howitt, 2016).

Table 1. Analysis that starts from codes to categories then themes

CODES	CATEGORIES	THEMES
Alternative communication amidst restrictions	Basic necessity	3.2.1 To seek other modes of communication
The need to communicate during times of crises		
Watching videos	Keeping occupied through the pandemic	3.2.2 To look for a source of entertainment
Sharing funny memes		
Voicing out problems	Expressing one's mind and thoughts	3.2.3 To express emotions
Providing a foundation to be more emotional		
Highly accessible for communicating	Being expressive during the pandemic	3.2.4 To spread positivity
Connecting people with different thoughts		
Younger generation being more understanding that older ones	Social media being a channel for relatedness in mental health	3.2.5 To spread awareness about mental health
Creating a discussion with others		
Spreading information and content about mental health awareness		
Sustained connection with friends, leading to healthy conversations during the pandemic	Source of positive content	3.3.1 Fear of familial judgment
Hesitating due to possible opinions of older family members	Worriedness due to reception of loved ones	
Being aware of unknown individuals	Doubt to the idea of openness	3.3.2 Fear of disingenuous reactions
Sudden and harsh judgment from others		



3. RESULTS AND DISCUSSIONS

3.1 Social Media Platforms Used by Teenagers

According to the majority of the respondents, due to these platforms' relevance and popularity in the country, the social media apps Messenger and Twitter were the primary platforms used by senior high school teenagers in maintaining their mental health through various methods, with some being vocal (constantly voicing out their concerns via posts), while more were reserved thus opting for private messaging or posting instead.

In one of the interviews, Pat (fictive names were used all throughout the discussion) explained her preference for Twitter when voicing out issues pertaining to her mental health:

"Twitter allows me to post what I feel on a certain topic without worrying on who can see it since Twitter has an option wherein you can hide your tweets on only people you follow". (All excerpts here are translated to full English)

Pat's contention may be one of the reasons why Twitter is popular among senior high school students, as it allows its users to have their personal platform in which they can voice out their feelings in a "safer route" of communication. Additionally, the feature that gives the user the option to have a private account allows them to choose who can view their tweets which makes it more appealing. Messenger, on the other hand, provides secure and private long-distance communication between students, which proved to be essential as social distancing is strictly enforced.

Some other platforms used by a minority of respondents are Facebook or Instagram, with Facebook being a choice mainly for leisure and Instagram only being used privately to post "stories" amongst their trusted peers.

3.2 Reasons for Using these Social Media Platforms in Dealing with Their Mental Health

There are four themes that emerged from the data as to why these teenagers used social media platforms in taking care of their mental health. These are (a) to seek other modes of communication, (b) to look for a source of entertainment (c) to express emotions, (d) to spread positivity, and (e) to raise awareness about mental health.

3.2.1 To seek other modes of communication

Respondents elaborated that social media provides a ground for them to find means of efficient

communication in a time when lockdowns and isolations are enforced. The necessity of using social media to communicate has also been evident, with mental health playing a role in the situation. RM stated:

"It's more of a need to use social media [now because] it could feel really isolating when you don't have anyone to talk to [on] a daily basis."

3.2.2 To look for a source of entertainment

Social media usage during the pandemic has spiked among young adolescents (Lurie Children's Hospital of Chicago, 2020). This is so since it seems that teenagers seek for a source of entertainment from these platforms. A respondent named Geralt spoke about using social media for entertainment, saying:

"[Because of the] pandemic, [we have nothing to do] without fun activities. [With me using] Twitter, [that has been my] source of entertainment during the pandemic."

3.2.3 To express emotions

Social media platforms are ideal for expressing one's self as its wide accessibility and ability to connect people has proven to be superior to other platforms. Kathy, speaking on the ability enabled by social media to be more emotional when using such platforms, commented:

"Twitter has allowed me to vent out my thoughts and really feel my emotions, and afterwards, I feel fresh and clear."

3.2.4 To spread positivity

Social media has become a place where some of the participants addressed their mental health needs by spreading positivity since it provides motivation and courage to address their personal issues. For instance, Mae used social media to spread positivity by sharing memes thinking that "everyone is having a bad time."

3.2.5 To spread awareness about mental health

Using social media fosters a healthy discussion among users. Furthermore, most of the interviewees have stated that social media has helped them immensely in nurturing their mental health by keeping them connected with their friends during the pandemic and through sharing information regarding mental health. Hakeem explained that:

"Me speaking on my mental health and spreading awareness about mental health in general is really helpful. My mutuals also give motivational statements that make you want to persevere"



3.3 Ways How Teenagers Use these Social Media Platforms in Dealing with Their Mental Health

There is one overarching theme emerging from the data as to the ways how the teenagers utilized these social media platforms. Teenagers used them with limitations due to one major reason. They tend to have not used the full features of the social media platforms because of “*fear*”, which has the following two sub-themes:

3.3.1 Fear of familial judgment

Familial judgment can be rooted out on the families that use social media and are “friends” or connected to each other. This can be one of the main factors why teenagers hesitate to use social media and its full features. For example, Mae did not want to tell them the full story of her struggle because if she told them about it, she “would not know how they will react because what hurts [her] may not hurt others”.

3.3.2 Fear of disingenuous reactions

Having millions of users, social media has a diverse group of users, and there is usually little to no way of knowing which users are sincere and which are not. This is primarily why a many of the respondents are often doubtful whenever someone decides to interact with their content. Pat stated:

“I know people that are being disrespected in social media just because they are expressing what they feel, it's either they are called out for being “fake”, or “over exaggerating” which may cause the individual to be more depressed”.

Overall, the present study’s findings support the previous claims about the positive use of social media in relation to mental health (Bekalu et al., 2019; Hardy & Castonguay, 2018). However, despite all the different positive effects that social media may have, the participants have also acknowledged that without a moderate balance or with constant and borderline addictive usage, social media could have a negative impact mentally, a claim reinforced by the studies done by Pantic (2014) and Rasmussen et al. (2020), in which they suggested that excessive use of social media may cause users difficulties in regulating their emotions.

4. CONCLUSION AND RECOMMENDATIONS

In summary, social media is a useful tool that can be used in various ways depending on an individual. It may be used to address mental health concerns publicly or privately depending on the purpose. Social media like Twitter, Instagram and

Messenger were mostly used to address teenagers’ concerns, to share information and spread positivity to those who are experiencing mental health issues.

Social media is essential in the pandemic as it became the medium of communication for among teenagers. However, effective as it seems, social media is still a level below face-to-face communication because in social media communication, we may not know the genuine or raw emotions of the person we are talking to. Face to face conversations eliminate this factor as it could cultivate more communicative genuineness.

For future research, we recommend creating a bigger pool of respondents with wider demographics and possibly employ quantitative perspectives to investigate the actual relationship of social media use and mental health.

5. ACKNOWLEDGMENTS

Our warmest gratitude extends to Mr. Janeson M. Miranda, our research adviser, who helped this work come into fruition. Nevertheless, the completion and progression of this research endeavor would not be close to possible without the kind assistance of our dear respondents. May this product be of good service towards those attesting the arduous process of shedding a brighter light to mental health and how it is particularly swayed by social media— a focal integration in a rapidly modernizing world.

6. REFERENCES

- Bekalu, M. A., McCloud, R. F., & Viswanath, K. (2019). Association of social media use with social well-being, positive mental health, and self-rated health: disentangling routine use from emotional connection to use. *Health Education & Behavior*, 46(2), 69S-80S. <https://doi.org/10.1177/1090198119863768>
- Dieris-Hirche, J., Bottel, L., Bielefeld, M., Steinbuchel, T., Kehyayan, A., Dieris, B., & Wildt, B. (2017). Media use and internet addiction in adult depression: A case-control study. *Computers in Human Behavior*, 68, 96-103. <https://doi.org/10.1016/j.chb.2016.11.016>
- Evans, S. (2021). Effects of the COVID-19 lockdown on mental health, wellbeing, sleep, and alcohol use in a UK student sample. *Psychiatry Research*, 298, 113-819. <https://doi.org/10.1016/j.psychres.2021.113819>
- Glazzard, J. & Stones, S. (2019). Social media and young people’s mental health. *Selected Topics in Child and Adolescent Mental Health*, 1, 1-14. <https://doi.org/10.5772/intechopen.88569>
- Groenewald, T. (2004). A phenomenological research design illustrated. *International Journal of Qualitative Methods*, 3(1), 42-55. <https://doi.org/10.1177/160940690400300104>



- Hardy, B. & Castonguay, J. (2018). The moderating role of age in the relationship between social media use and mental well-being: An analysis of the 2016 general social survey. *Computers in Human Behavior*, 85, 282-290. <https://doi.org/10.1016/j.chb.2018.04.005>
- Howitt, D. (2016). *Introduction to Qualitative Research Methods in Psychology* (3rd ed.). Pearson Education Limited.
- Lester, S. (1999). *An introduction to phenomenological research*. Stan Lester Developments. https://www.researchgate.net/publication/255647619_An_introduction_to_phenomenological_research
- Lurie Children's Hospital of Chicago. (2020, September 1). Parenting teens in the age of social media. <https://www.luriechildrens.org/en/blog/social-media-parenting-statistics/>
- Morrow, S. L. (2005). Quality and trustworthiness in qualitative research in counseling psychology. *Journal of Counseling Psychology*, 52(2), 250-260. <https://doi.org/10.1037/0022-0167.52.2.250>
- Rasmussen, E., Punyanunt-Carter, N., LaFreniere, J., Norman, M., & Kimball, T. (2020). The serially mediated relationship between emerging adults' social media use and mental well-being. *Computers in Human Behavior*, 102, 206-213. <https://doi.org/10.1016/j.chb.2019.08.019>
- University of Surrey (2021, March 22). COVID-19 pandemic severely impacts mental health of young people. <https://medicalxpress.com/news/2021-03-covid-pandemic-severely-impacts-mental.html>
- Zhao, N. & Zhou, G. (2020). Social media use and mental health during the COVID-19 pandemic: Moderator role of disaster stressor and mediator role of negative affect. *Applied Psychology: Health and Well-Being*, 12(4), 1019-1038. <https://doi.org/10.1111/aphw.12226>



The Efficacy of BRafeNHS Student Representative Coordinating Council A.Y. 2020-2021

Justin Frederick P. Abando and Arabella Mae M. Aduiso
De La Salle Santiago Zobel – Br. Rafael Donato FSC Night High School, Muntinlupa City

Abstract: The student council serves as the voice of the student body, enabling them to be engaged in tackling academic matters (Woods, 2002). With the implementation of online distance learning, the duties of the student council should not cease even with the new factors affecting their proceedings. This study aims to find out if the BRafeNHS Student Representative Coordinating Council is still functioning effectively amidst the set-up of online distance learning what is the student body’s perception of their performance, and how it differs from the student leaders’ perception. Researchers disseminated a survey questionnaire to 75% of the BRafeNHS student body to rate the performance of the Executive, Legislative, and Media Committee. In evaluating the student council performance, four variables were considered in this study (authority, communication with students, implementation of school rules, and project implementation and student involvement). Interviews were also held with selected students from the council and student body to provide a more in-depth inquiry. Results showed that the BRafeNHS-SRCC is still functioning very effectively based on the student body, and they share almost the same perception on the first two variables, although the same cannot be said for the latter two. Still, the research concludes that the BRafeNHS-SRCC is functioning effectively amidst the implementation of online distance learning.

Key Words: student-leaders; leadership skills; online distance learning; student body; perceived performance

1. INTRODUCTION

According to Woods (2002), the student council is an organization serving as the representative, allowing the student body to become more involved with the school’s affairs. With it, the students will have a voice. And for the student council to uphold its purpose, it will have different responsibilities and duties to perform. The responsibilities of the student council may vary from school to school, but are summarized as the following:

Planning, Proposing, and Managing Activities. The student council is tasked to plan and manage different events and activities that will happen in and out of the school within the school year. These activities are not limited to projects proposed by the student council itself; but also programs that are done annually and as suggested by the school management. Specifically, they will have to prepare everything needed for the program, execute the plan, and oversee the project or activity until the end, ensuring its success.

Involvement of Students in the Activities of the Council. The student council has the job of ensuring the participation of the student body in its activities. Such events will serve as the best way to involve the school administration and the students, therefore regularly holding it is the essential job of

the council. The student council will not be able to carry out the purpose of the activity or event if neither the students nor the school management will be involved.

Communication with the Student Body. The student council must establish the best way to communicate with the students from different grade levels and sections. To ensure that the student council will stay connected and updated with the student body, batch representatives are usually appointed to know the concern that has to be addressed.

Working in Partnership with the School Administration. Although they serve as the representative of the student body, the student council will also be working together with the administration, teachers, Association of Parents in facilitating matters that concerns the student body.

Financial Management. The student council projects and activities will be all covered by the budget provided by the school, which should be maximized for reasonable and worth causes. . The student council will also host different fundraising programs to gain extra money that can be either added to the council’s budget or used for charitable purposes to beneficiaries.

Out of all responsibilities stated, establishing regular and effective communication with the



students is the way to a successful student council. And without effective communication between the two parties, they would not be able to perform their purpose. In the case of the BRafeNHS community, the school is under the online distance learning (ODL) for the academic year 2020-2021 due to the COVID-19 pandemic. With massive limitations in communication during ODL, the performance of the BRafeNHS Student Representative Coordinating Council (BRafeNHS-SRCC) would be determined by their way of implementing projects and the involvement of the student body with it, the enforcement of school rules, and their established authority.

This research will not criticize the student council as the researchers only aimed to see the performance of the BRafeNHS-SRCC during ODL based on the set variables.

2. STATEMENT OF THE PROBLEM

Generally, this study aims to find out if the performance of the BRafeNHS-SRCC was not affected by the implementation of ODL. Specifically, it will answer the following questions:

1. What is the student body's perceived performance of the BRafeNHS-SRCC during ODL in terms of:
 1. authority;
 2. communication with the student body;
 3. implementation of school rules and regulations; and
 4. implementation of projects and student involvement?
2. How is the perception of the student-leaders on their performance during ODL different from the perception of the student body?
3. Does the BRafeNHS-SRCC continue to function effectively with the implementation of ODL for A.Y 2020-2021?

3. HYPOTHESIS

The following are the null and alternative hypotheses of this research.

3.1 Null Hypothesis

The BRafeNHS-SRCC is functioning effectively amidst the implementation of ODL for A.Y. 2020-2021, based on the perception of the student body.

3.2 Alternative Hypothesis

The BRafeNHS-SRCC is not functioning effectively amidst the implementation of ODL for A.Y. 2020-2021, based on the perception of the student body.

4. Methodology

The researchers administered a survey questionnaire to the 75% of the total population of BRafeNHS students with a 5% margin of error to know the perspective of the student body about the performance of the BRafeNHS-SRCC during ODL. Some of the respondents, selected through a direct selection method, were interviewed by the researchers for an in-depth analysis of their perspective.

The BRafeNHS-SRCC committees for this study were the Executive, Legislative, and Media. The following committees were assessed for the study due to their functions: the Executive Committee presides over the entire student council; the Legislative Committee involves the level representative who handles the concern of a batch they hold and supervise the class officers; and the Media Committee is responsible for the social media accounts and online programs of the council. The researchers believed that these leaders are in the frontlines of council activities even in ODL.

The mentioned student-leaders also answered the survey questionnaire on how they perceived their performance during online distance learning and were also interviewed by the researchers. It allowed the researchers to compare and contrast the data coming from the different groups of participants and formulate more concrete and comprehensive conclusions about the effectiveness of the student-leaders during ODL.

In analyzing the collected quantitative data, the researchers used Descriptive Statistical Analysis. The measure of central tendency (mean) constitutes a prerequisite for the t-test. The two-tail independent sample T-test showed how significant the differences between the perspective of student-leaders and student body were.

5. RESULTS AND DISCUSSION

TABLE 1: PERFORMANCE OF THE STUDENT-LEADERS AS PERCEIVED BY THEMSELVES

STUDENT-LEADER	MEAN SCORES OF PERCEIVED PERFORMANCE			
	Authority	Communication with the Student Body	Implementation of School Rules and Regulations	Implementation of Projects and Student Involvement
A	3.60	3.50	2.80	4.00
B	3.60	3.67	4.00	4.00
C	3.80	3.83	4.00	4.00
D	3.40	3.83	3.60	3.75
E	3.20	3.00	2.60	2.75
F	3.80	3.83	3.00	3.00
G	3.60	3.00	2.40	4.00
H	3.00	3.33	3.60	3.00
I	2.40	3.17	1.80	4.00
J	4.00	4.00	4.00	4.00
K	4.00	3.83	4.00	4.00
L	3.80	3.67	4.00	3.75
M	4.00	3.83	3.80	4.00
N	3.60	3.67	3.60	3.75
O	2.80	2.67	3.00	2.75
P	4.00	4.00	4.00	4.00
Q	4.00	3.83	4.00	4.00
R	4.00	4.00	4.00	4.00
S	2.80	2.83	2.20	3.25
T	3.00	3.50	3.20	3.00
U	2.00	2.00	2.40	2.00



One of the objectives of this research was to determine the perception of the student-leaders on their performance during ODL. This study considered four variables as a means to rate the student council.

The first variable, an established authority, 17 out of 21 student-leaders scored 3.00 or higher in their mean scores. Student-Leader U had the lowest mean score of 2.00, followed Student-Leader I with 2.40. Two student-leaders had a mean score of 2.80 and another of 3.00. Student-Leader D and E with a mean score of 3.20 and 3.40 respectively; four student-leaders had 3.60; three more with 3.80; and six student-leaders scored perfect 4.00. Based on this, most of the BRafeNHS-SRCC had confidence in their authority, with the latter still improving.

In the second variable, communication with the student body, 18 student-leaders scored 3.00 or higher mean score: Student-Leader U with the lowest with 2.00; followed by Student-Leader O with 2.67; then Student-Leader S with 2.83. Two student-leaders scored 3.00, Student-Leader I and H with 3.17 and 3.33 respectively, another two with 3.50 and three more with 3.67. There are six student-leaders with a score of 3.83 and three with a perfect score of 4.00. The results were very similar to the first variable, which means that the BRafeNHS-SRCC was sure that they did not neglect the student body's needs.

For the third variable, implementation of school rules, 15 student-leaders scored 3.00 or higher, with Student-Leader I having 1.80, the lowest mean score. It was followed by Student-Leader S with 2.20, next is Student-Leader G and U having 2.40, then by Student-Leader E with 2.60. Student-Leader F and O acquired 3.00, Student-Leader M attained 3.80, and eight student-leaders have 4.00. It entails that the BRafeNHS-SRCC was quite unsure if they enforced school rules enough, affected by both the new set-up and delegation of tasks.

Lastly, in project implementation and student involvement, 18 student-leaders scored 3.00 or higher: Student-Leader U scored the lowest with 2.00 while Student-Leader E and O scored 2.75. Three student-leaders scored 3.00, Student-Leader S with 3.25, another three with 3.75, and the remaining eleven officers obtained 4.00. These data confirmed that the BRafeNHS-SRCC believed they did more than enough in launching and promoting their projects.

Moreover, during the interview with the student-leaders: The Executive Committee mentioned that communication inside the council is one of their problems. They also scored the lowest on the variable of Authority and/or Implementation of Rules as they believe it was not within the scope of their responsibilities. The Legislative committee said that communicating with the student body had been a challenge as not everyone has an internet connection.

They also never exercised their authority to give violation reports during ODL. The Media Committee was overwhelmed with the number of responsibilities they have during ODL and believes that they were only efficient in implementing projects.

TABLE 2: PERFORMANCE OF THE STUDENT-LEADERS AS PERCEIVED BY THE STUDENT BODY

STUDENT-LEADER	MEAN SCORES OF PERCEIVED PERFORMANCE			
	Authority	Communication with the Student Body	Implementation of School Rules and Regulations	Implementation of Projects and Student Involvement
A	3.55	3.54	3.55	3.59
B	3.45	3.45	3.49	3.53
C	3.42	3.41	3.43	3.50
D	3.48	3.50	3.48	3.53
E	3.43	3.42	3.45	3.48
F	3.52	3.48	3.48	3.52
G	3.47	3.45	3.47	3.50
H	3.38	3.52	3.48	3.56
I	3.45	3.59	3.38	3.56
J	3.39	3.40	3.32	3.37
K	3.58	3.58	3.58	3.70
L	3.34	3.35	3.34	3.30
M	3.63	3.66	3.65	3.80
N	3.44	3.45	3.50	3.57
O	3.41	3.38	3.36	3.36
P	3.42	3.41	3.47	3.46
Q	3.68	3.65	3.68	3.66
R	3.79	3.76	3.76	3.81
S,T,U	3.46	3.45	3.44	3.51

The main objective of this research was to determine the perceived performance of the student-leaders in terms of authority, communication with the student body, implementation of school rules, and project implementation and student involvement. Student-Leader S, T, and U scored as one given that their work was not individually divided. Hence it was not rated per officer.

In the variable perceived authority, all student-leaders scored a mean score higher than 3.30, three of which scored in the range of 3.30-3.39. Ten student-leaders have scores falling between 3.40-3.49, and another three collected scores between 3.50-3.59. Student-Leader M scored 3.63, Student-Leader Q had 3.68 as the mean score, and Student-Leader R scored the highest with 3.79.

As for the variable communication with the students, all student-leaders scored higher than 3.30. Student-Leader L scored the lowest mean with 3.35, followed by Student-Leader O with 3.38. Nine student-leaders attained scores in the range of 3.40-3.49 and five student-leaders between 3.50-3.59. Student-Leader Q and M scored 3.65 and 3.66, respectively, and Student-Leader R scored 3.76, the highest among the scores.

With the variable implementation of school rules, four student-leaders scored between 3.30-3.39, nine had scores within the range of 3.40-3.49, and three student-leaders obtained scores between 3.50-3.59, two had scored between 3.60-3.69, and Student-Leader R scored the highest, with a mean score of 3.76.

In the last variable, project implementation and student involvement, three student-leaders scored within the range of 3.30-3.39, another two between 3.40-3.49, and ten student-leaders between 3.50-3.59. Student-Leader Q had a mean score of 3.66; Student-Leader K has 3.70, Student-Leader M with 3.80; and Student-Leader R scored the highest (3.81).



Moreover, during the interview, the students recognized how the BRafNHS-SRCC implemented more projects during ODL than on face-to-face; and how the legislative committee addresses their concerns. However, they did not think that the BRafNHS-SRCC was efficient in implementing rules and establishing authority. They also did not know who the other members of the student council are, other than the president, and their respective level representative.

The majority of the student-leaders acquired 3.40-3.49 mean scores in each variable, except on the variable of project implementation and student involvement which placed the most scores in the range of 3.50-3.59. Therefore, the researchers conclude that the BRafNHS-SRCC is doing great in their performance during the ODL.

TABLE 3: EVIDENCE OF RELATIONSHIP BETWEEN THE PERCEPTIONS OF THE STUDENT LEADERS AND STUDENT BODY

STUDENT-LEADER	P VALUE	INTERPRETATION
A	I. 0.863	I. No Evidence
	II. 0.877	II. No Evidence
	III. 0.198	III. No Evidence
	IV. 0.000004	IV. Very Strong Evidence
B	I. 0.369	I. No Evidence
	II. 0.360	II. No Evidence
	III. 0.0000001	III. Very Strong Evidence
	IV. 0.000004	IV. Very Strong Evidence
C	I. 0.131	I. No Evidence
	II. 0.054	II. Weak Evidence
	III. 0.000002	III. Very Strong Evidence
	IV. 0.00001	IV. Very Strong Evidence
D	I. 0.755	I. No Evidence
	II. 0.100	II. Weak Evidence
	III. 0.452	III. No Evidence
	IV. 0.440	IV. No Evidence
E	I. 0.366	I. No Evidence
	II. 0.303	II. No Evidence
	III. 0.026	III. Moderate Evidence
	IV. 0.226	IV. No Evidence
F	I. 0.230	I. No Evidence
	II. 0.089	II. Weak Evidence
	III. 0.0000009	III. Very Strong Evidence
	IV. 0.000003	IV. Very Strong Evidence
G	I. 0.433	I. No Evidence
	II. 0.0000006	II. Very Strong Evidence
	III. 0.012	III. Moderate Evidence
	IV. 0.000004	IV. Very Strong Evidence
H	I. 0.0003	I. Very Strong Evidence
	II. 0.421	II. No Evidence
	III. 0.664	III. No Evidence
	IV. 0.00001	IV. Very Strong Evidence
I	I. 0.013	I. Moderate Evidence
	II. 0.231	II. No Evidence
	III. 0.001	III. Strong Evidence
	IV. 0.00002	IV. Very Strong Evidence
J	I. 0.000002	I. Very Strong Evidence
	II. 0.0000002	II. Very Strong Evidence
	III. 0.000002	III. Very Strong Evidence
	IV. 0.0000002	IV. Very Strong Evidence
K	I. 0.00001	I. Very Strong Evidence
	II. 0.190	II. No Evidence
	III. 0.000007	III. Very Strong Evidence
	IV. 0.0001	IV. Very Strong Evidence
L	I. 0.083	I. Weak Evidence
	II. 0.196	II. No Evidence
	III. 0.000004	III. Very Strong Evidence
	IV. 0.171	IV. No Evidence
M	I. 0.0006	I. Very Strong Evidence
	II. 0.335	II. No Evidence
	III. 0.0002	III. Very Strong Evidence
	IV. 0.003	IV. Strong Evidence
N	I. 0.558	I. No Evidence
	II. 0.344	II. No Evidence
	III. 0.709	III. No Evidence
	IV. 0.516	IV. No Evidence
O	I. 0.180	I. No Evidence
	II. 0.086	II. Weak Evidence
	III. 0.463	III. No Evidence
	IV. 0.093	IV. Weak Evidence
P	I. 0.000002	I. Very Strong Evidence
	II. 0.000001	II. Very Strong Evidence
	III. 0.00002	III. Very Strong Evidence
	IV. 0.00003	IV. Very Strong Evidence
Q	I. 0.00005	I. Very Strong Evidence
	II. 0.323	II. No Evidence
	III. 0.00002	III. Very Strong Evidence
	IV. 0.003	IV. Strong Evidence
R	I. 0.0002	I. Very Strong Evidence
	II. 0.000002	II. Very Strong Evidence
	III. 0.0004	III. Very Strong Evidence
	IV. 0.003	IV. Strong Evidence
S.T.U	I. 0.0003	I. Very Strong Evidence
	II. 0.015	II. Moderate Evidence
	III. 0.013	III. Moderate Evidence
	IV. 0.003	IV. Strong Evidence

To answer the second research question, the third table shows the evidence of the relationship between the perceptions of the student body and student-leaders.

I. Authority

Very strong evidence: 8 student-leaders
Moderate evidence: 1 student-leader
Weak evidence 1 student leader
No evidence: 9 student-leaders

In the variable authority, nine student-leaders had no evidence that the student-leaders perceived their performance as the same as the student body. Eight student-leaders had very strong evidence; one acquired moderate evidence, and another one had weak evidence.

II. Communication with the Student Body

Very strong evidence: 4 student-leaders
Moderate evidence: 1 student-leader
Weak evidence 4 student leaders
No evidence: 10 student-leaders

For this variable, ten student-leaders had no evidence; four student-leaders got very strong evidence; one student-leader for moderate evidence; and four with weak evidence. The majority of BRafNHS-SRCC had a similar perception of their performance with those of the student body.

III. Implementation of Rules and Regulations

Very strong evidence: 10 student-leaders
Strong evidence: 1 student-leader
Moderate evidence: 3 student-leaders
No evidence: 5 student-leaders

As for the third variable, ten student-leaders had very strong evidence; one got strong evidence; three with moderate evidence; and five for no evidence. The data showed that for this variable, the BRafNHS-SRCC and student body had different perceptions.

IV. Implementation of Projects and Student Involvement

Very strong evidence: 10 student-leaders
Strong evidence: 4 student-leaders
Weak evidence: 1 student-leader
No evidence: 4 student-leaders

For the last variable, ten student-leaders obtained very strong evidence. Four student-leaders acquired strong evidence; 1 student-leader with weak evidence; and another four student-leaders got no evidence. Again, for this variable, the BRafNHS-SRCC and student body had different perceptions.

6. CONCLUSIONS

Although some of the student-leaders doubted their performance due to inconsistent activeness in the student council, internet connection problems, being new to ODL, and performance criticisms. The study showed that the BRafNHS-SRCC did a great job during ODL. While working as a council, each member had their specific task assigned



to them that could affect or limit what they could do about their performance. Nonetheless, the researchers can conclude that the student body perceived the student-leaders of BRafeNHS-SRCC to be effective with their assigned tasks. Therefore, the researchers accepted the null hypothesis and rejected the alternative hypothesis.

The researchers were also able to identify, through the interpretation of the P-value, that there is no difference between the perceptions of the student-leaders and student body on the variables authority and communication with the student body. For the rules and regulations implementation and Implementation of projects and student involvement, the data entailed that the student-leaders and the student body perceived the former's performance differently.

7. RECOMMENDATIONS

The study showed that BRafeNHS-SRCC continued to perform effectively despite the implementation of ODL. However, the researchers still hope for improvements for the future academic years in ODL. Implementing projects that promote inclusivity and a system wherein the student council and student body can communicate despite having low or no internet connection, and projects that help the students academically and mentally. Most of the interviewees from the student body and student-leaders identified internet connection and mental health as their main challenges during ODL. Hence, communication within the student council and between the student-leaders and student body should be strengthened during ODL as it would help for the betterment of everyone and the service and leadership of the student council.

For future researchers, the researchers recommend finding a way to distribute the survey questionnaire in each section/batch equally, for more comprehensive and accurate data. It is also better to check first the delegated task of each student-leader to sense the scope and limitations of the study.

8. ACKNOWLEDGMENTS

The completion of this research could not have been possible without the participation and assistance of so many people whose names may not all be enumerated. Their contributions were sincerely appreciated and gratefully acknowledged. However, we would like to express our deep appreciation and indebtedness particularly to the following:

To Dr. Heidi Marie Padua, Mr. Jayson Mendoza, Mr. Julian Jeremy Teodoro, and Ms. Djouana Rose Manjares for their assistance and suggestions in the validation of the data-gathering instruments. Also, the other members of our group,

Mary Christine Maala and Sandra Santos, who helped us in the process of writing this manuscript.

To our research adviser, Ms. Shelica Lalucha Tan, for giving us the opportunity to do research and providing invaluable guidance throughout the research. It was a great privilege and honor to work and study under her guidance. We would also like to thank her for her motivation, sincerity, patience, friendship and great sense of humor during the discussion we had with her on research work.

To all relatives, friends, and others, who, in one way or another shared their support, either morally, financially and physically, thank you.

Above all, to the Great Almighty, the author of knowledge and wisdom, for his countless blessings.

9. REFERENCES

- Alviento, S. G. (2018) Effectiveness of the Performance of The Student Government of North Luzon Philippines State College. ResearchGate. doi: 10.17810/2015.67
- Badarna, L. K., & Ashour, M. H. (2016). Role of School Administration in Solving Students' Problems among Bedouin Schools within the Green Line in Palestine. Education Resources Information Center. <https://files.eric.ed.gov/fulltext/EJ1092488.pdf>
- Beketova, E., Leontyeva, I., Zubanova, S., Gryaznukhin, A., & Movchun, V. (2020). Creating an optimal environment for distance learning in higher education: Discovering leadership issues. ResearchGate. doi: 10.1057/s41599-020-0456-x
- Black, R., Walsh, L., Magee, J. Hutchins, L. German N. & Groundwater-Smith, S. (2014). Student leadership: a review of effective practice. Canberra: ARACY. https://education.nsw.gov.au/student-wellbeing/media/documents/attendance-behaviour-engagement/engagement/StudLead_LitReview_fullrpt.pdf
- Bukaliya, R. & Rupande, G. (2012). Assessing the Effectiveness of Student Representative Council in Open and Distance Learning: A Case for the Zimbabwe Open University. International Journal on New Trends in Education and Their Implications. <https://arastirmax.com/tr/publication/international-journal-new-trends-education-and-their-implications/3/1/assessing-effectiveness-student-representative-councils-open-and-distance-learning-case-zimbabwe>
- Campaner, M. (2017). The Importance of Student Council: Bridging the Gap. yuda bands. <https://www.yudabands.org/the-importance-of-student-council/#:~:text=Being%20part%20of%20the%20student,of%20a%20chore%20or%20requirement>
- Cayabyab, M. S. K. A. & Racho, M. M. M. (2015). The Effects of Student Government in Makati High Schools. Academia. https://www.academia.edu/15547571/Research_Paper_on_the_Effects_of_the_Student_Government_in_Makati_High_School
- Chapman, A. (2020). Tuckman: Forming, Storming, Norming, Performing model. BusinessBalls. <https://www.businessballs.com/team->



- management/tuckman-forming-storming-norming-performing-model/z
- Charles, K. A. (2015). Factors Influencing Effectiveness of Student Councils in Public Secondary Schools in Kirinyaga East Sub-County, Kenya. University of Nairobi Digital Repository. <http://hdl.handle.net/11295/90798>
- Collie, R. J., & Martin, A. J. (2016). Adaptability: An Important Capacity for Effective Teachers. ResearchGate. doi: 10.7459/ept/38.1.03
- Crisostomo, J. L. S., Dela Cruz, J. A. J. R., Galsim, K. P., Sanchez, S. M., & Tamparong, E. M. E. (2020). The Relationship Between the Selected BRafeNHS SRCC Student-Leaders' Leadership Styles and their Perceived Performance of Academic Year 2019-2020.
- Dzivhani, M. D. (2000). The Role of Discipline in School and Classroom Management: A Case Study. CORE. <https://core.ac.uk/download/pdf/43175949.pdf>
- Ganti, A. (2019). P-test. Investopedia. <https://www.investopedia.com/terms/p/p-test.asp>
- Griebler, U. and Nowak, P., (2012). Student Councils: A Tool For Health Promoting Schools? Characteristics And Effects. Researchgate. doi: 10.1108/09654281211203402
- Grigoropoulos, J. E. (2020). How Can Manifesting Leadership Skills Infused with Ethos, Empathy, and Compassion Better Prepare Students to Assume Leadership Roles? International Journal of Progressive Education. 16(1), 54-66. <https://eric.ed.gov/?id=EJ1245093>
- Irlbeck, S., (2002). View Of Leadership And Distance Education In Higher Education: A US Perspective | The International Review Of Research In Open And Distributed Learning. Irrodl.org. The International Review of Research in Open and Distributed Learning. <http://www.irrodl.org/index.php/irrodl/article/view/91/170>
- Labor, J. (2017). Filipino Student Council Heads' Leadership Frames: A Phenomenographic Inquiry. ResearchGate. https://www.researchgate.net/publication/317041692_Filipino_student_council_heads'_leadership_frames_a_phenomenographic_inquiry
- Marcus, S., (2004). Leadership In Distance Education: Is It A Unique Type Of Leadership - A Literature Review. Online Journal of Distance Learning Administration. <https://www.westga.edu/~distance/ojdl/spring71/marcus71.html>
- Singh, P. (2013). P Value, Statistical Significance and Clinical Significance. J Clin Prev Cardiol. 2013;2(4):202-4. <https://www.jcpcarchives.org/full/p-value-statistical-significance-and-clinical-significance-121.php>
- Toggl Track. (n.d.). 5 Stages of Team Development. toggl track. <https://toggl.com/track/stages-of-team-development/>
- Ward, S. (2020) What is Leadership? the balance smb. <https://www.thebalancesmb.com/leadership-definition-2948275#:~:text=Balance's%20editorial%20policies-,Susan%20Ward,to%20meet%20the%20company's%20needs.>
- Woods, M. (2002). Student Councils: A voice for Students. Department of Education and Science. https://www.education.ie/en/Schools-Colleges/Information/Post-Primary-School-Policies/student_council_voice.pdf



Two Roads that (should) Converge: Perceived Effectiveness of Synchronous and Asynchronous Learning by Senior High School Students at José Rizal University

Aryl Fatima V. Tunay, Patricia Geneva Q. Dela Torre, Kaye Anne V. Macdon
Arron Raymunds C. Jose, and Bonjovi H. Hajan
St. Edward School, General Trias City, Cavite

Abstract: With the outbreak of the COVID-19 pandemic, online learning has become the students' only hope to continue their learning process in a safe and secure manner. This study aimed to examine the perceived effectiveness of synchronous and asynchronous learning and evaluate the factors which may affect students' experience in such a highly emergent learning context. To this end, descriptive quantitative research involving 100 conveniently selected senior high school students enrolled in online classes at a private university was conducted. A researcher-developed, expert-validated four-point rating scale consisting of four parts was administered to the respondents online via SurveyHero. The responses were analyzed using descriptive statistics, mean and standard deviation. The results indicated that, while students perceived synchronous learning as effective and in-par with face-to-face classes, they reported a negative evaluation of the efficacy of asynchronous learning. The study further revealed that factors such as gadgets and a peaceful home environment were essential for successful online learning. It was then concluded that synchronous learning is more effective than asynchronous, and the quality of learning materials provided to the students impact their views on these learning set-ups. The study draws several pedagogical implications useful for both students and teachers in online learning environments. Recommendations for future research are also discussed in this paper.

Key Words: online learning environment, asynchronous learning, synchronous learning

1. INTRODUCTION

Online learning has become a central issue that has arisen in today's educational landscape. With the outbreak of the COVID-19, all aspects of the country suffered heavily, including education which affected nearly 1.6 billion learners globally (United Nations, 2020). Consequently, the adoption of online learning has been spurred to prevent the spread of the virus (Dennon, 2021).

Online learning provides opportunities for students to continue their learning process in a safe and secure manner despite the pandemic (Khalil et al., 2020). Online learning can be synchronous or asynchronous. Synchronous learning refers to the type of class sessions that takes place in real-time, while asynchronous learning is where the students are self-paced and learn without the supervision of their instructors (Scheider, 2021).

Several past works on the effectiveness of synchronous and asynchronous learning have been conducted. Hrastinski's study (2008) found that synchronous learning is deemed more beneficial by students because the learners thought of synchronous communication as "more like talking." Meanwhile,

Kenworthy and McNamara (2012) affirmed that synchronous engagement with the courses or modules caused the students' final examination grades and course grades to rise. On the other hand, asynchronous sessions have been proven effective in promoting creativity in project-based prompts (Beck & Corfman, 2019). Similarly, Hrastinski (2008) proved that, in asynchronous discussions, students can articulate their thoughts better because they can find more facts and read other source materials to grasp the lesson better. Moreover, in asynchronous communication set-ups, the person's capability to understand the information at hand improves (Dennis & Robert, 2005), suggesting that students may be able to process the lessons they have more thoroughly when learning asynchronously.

Despite the prevalence of previous research conducted on online learning, some questions, however, remain unresolved. This is because students now do not get the chance to choose online learning voluntarily since, because of the pandemic, online classes are being imposed upon them. For example, in the Philippines, the Department of Education adopted distance learning methods, which include online learning to facilitate the students' education (Llego,



2020). This then creates a gap if one wants to assess the effectiveness of online learning in such a highly emergent context. In addition, the issue of internet connectivity and digital readiness (Kritz, 2020) is not present in other research, while it may be a big problem in the Philippine setting.

Hence, this study was conducted to determine the perceived effectiveness of online learning. Specifically, this study was designed to answer the following research questions:

1. How effective is synchronous learning as perceived by the students?
2. How effective is asynchronous learning as perceived by the students?
3. What factors in synchronous and asynchronous learning environments do students have to cope with?
4. What strategies do the students utilize to cope with the synchronous and asynchronous learning demands?

2. METHODOLOGY

A quantitative approach, specifically descriptive research design, was applied in this study. The study respondents were 100 Senior High School (SHS) students who were enrolled in online classes at Jose Rizal University (JRU); they were selected through convenience sampling. This sampling technique allowed the researchers to choose those who were more readily accessible given the context of online data collection (Etikan et al., 2016). This means that during the initial data collection, more than 100 students were recruited to participate. However, only 100 students willingly responded to the questionnaire within the timeframe set for the data collection. A four-point Likert scale was developed by the researchers after a careful literature review on online learning—the questionnaire comprised four parts, with each part addressing each research question posed in this study. The original version of the questionnaire only had three parts, totaling 20 items. After an expert validation, an additional part (Part 4) was added to the questionnaire, and an additional statement was added to Part 1 and Part 2, making a total of 26 items. Several statements were also revised to improve their clarity.

Data collection was undertaken through an online survey via SurveyHero. Before the respondents participated, their consent and assent to partake in the research were acquired. The entire data collection lasted for a week due to the number of responses needed.

Descriptive statistics, mean and standard deviation (SD) were used in the data analysis. The responses were first collated in Microsoft Excel. The mean and SD of each item were then calculated. After calculations were done, the data were tabulated, and

each item was interpreted using the range of mean scores, whereas 3.26-4.00 equated to strongly agree; 2.51-3.25 to somewhat agree; 1.76-2.50 to somewhat disagree; and 1.00-1.75 to strongly disagree.

3. RESULTS AND DISCUSSION

3.1 How effective is synchronous learning as perceived by the students?

Table 1 shows a grand mean of 2.97, indicating that the students somewhat agree that synchronous class effectively accommodates their academic needs. Moreover, the results indicate that students strongly agree that the instructional materials utilized during synchronous sessions are relevant to their needs. Similar outcomes can be learned from past works. For example, the study of Francescucci and Rohani (2018) reported that synchronous courses have the same level of student performance outcomes as with face-to-face learning because of effective instructional materials. In the current study, teachers may have utilized various teaching materials which get positive engagement from the students, as explained by the highest mean in item 1. Moreover, learners value spontaneous feedback and meaningful interactions, which are present during synchronous sessions (Bonk & Park, 2007), and could be the significant reasons why the students generally show a positive attitude towards the aforementioned learning set-up.

Table 1 *Effectiveness of Synchronous Learning as Perceived by the Students*

Items	Mean	SD	Verbal interpretation
1. The instructional materials used during synchronous classes are appropriate and suited for my academic needs.	3.36	0.61	Strongly agree
2. Subject teachers utilize various strategies to encourage active learning among students, which enables me to learn more effectively.	3.21	0.66	Somewhat agree
3. My internet connectivity is good and conducive for learning, so I am able to keep up with the discussions.	2.65	0.88	Somewhat agree
4. I can easily interact with my teachers, so the questions I have in mind are clarified immediately and clearly.	2.91	0.88	Somewhat agree
5. I can easily interact with my classmates, and we are able to discuss the content of a topic, which enables me to take the level of depth into a topic	3.03	0.90	Somewhat agree



further than the instructor's presentation alone would.			
6. I get higher grades on my assessments when the topic is taught in synchronous sessions than when I do under the synchronous classes.	3.03	0.81	Somewhat agree
7. I can say that synchronous learning is in-par with face-to-face classes when it comes to the quality of learning that I get from it.	2.62	0.98	Somewhat agree
Grand mean	2.97	0.82	Somewhat agree

3.2 How effective is asynchronous learning as perceived by the students?

In Table 2, it is revealed that students somewhat disagree that asynchronous classes are effective, as indicated by the grand mean of 2.48. The result also shows that the students do not perceive asynchronous learning as on par with traditional classes, as shown by the 2.13 mean for item 7. The students' negative outlook towards asynchronous classes may be caused by their lack of experience with the mentioned learning set-up. Several studies prove that, by practice, asynchronous learning does not work as designed due to students' lack of perceptions of interdependence (Peterson et. al, 2018). Since the students are new to the asynchronous modality, it may be harder to adjust to the schedule flexibility and interdependence given to them. Moreover, students tend to have a greater interest in synchronous activities as those are more interactive and reinforce knowledge retention better than asynchronous tasks (Malik et al., 2017). This finding also offers a probable explanation as to why the students' perception regarding the effectiveness of asynchronous classes is substandard.

Table 2 *Effectiveness of Asynchronous Learning as Perceived by the Students*

Items	Mean	SD	Verbal Interpretation
1. The instructional materials uploaded in Canvas are clear and easy to understand, and the modules are arranged properly; thus, I am able to learn effectively even without the supervision of a teacher.	2.46	0.91	Somewhat disagree
2. There are different types of instructional and supplementary materials provided by the teachers (e.g., video presentations, recording of the discussions, etc.) that help me understand the lessons better.	2.49	0.89	Somewhat disagree

3. The subject teachers use different strategies such as evaluation tests and lesson sharing to assess what I learned about the topic.	2.72	0.93	Somewhat agree
4. I can easily reach my subject teachers through email or using Canvas inbox whenever I have questions regarding the modules or lessons.	2.05	0.93	Somewhat disagree
5. The time I allot for different topics/subjects allows me to focus well, thus helping me learn at my own pace.	2.74	0.92	Somewhat agree
6. I get higher grades on my assessments when I study under an asynchronous set-up than when I do under synchronous classes.	2.77	0.95	Somewhat agree
7. I can say that asynchronous learning is in-par with face-to-face classes when it comes to the quality of learning that I get from it.	2.13	0.97	Somewhat disagree
Grand mean	2.48	0.93	Somewhat disagree

3.3 What factors in synchronous and asynchronous learning environments do students have to cope with?

As shown in Table 3, the grand mean of 2.49 indicates that the students somewhat disagree that their study environment is conducive to learning. The results generally show that the students' home environment is not that beneficial in helping them learn better, implying that students may be having a more challenging time learning at home than in a classroom. Students taking the course in a traditional classroom setting outperformed their peers who study at home because of the presence of various distractions (Brooks, 2011). Also, Perks (2014) stated that, given the profound influence of the physical environment on their learning competency, the slightest distractions around the students' workspace could significantly impact their learning behavior. In the present study, distractions such as household chores and the presence of gadgets and other factors such as a peaceful home environment may have contributed significantly to how students perceive the conduciveness of their home as their learning environment.

Table 3 *Factors in Synchronous and Asynchronous Learning that Students have to Cope with*

Items	Mean	SD	Verbal interpretation
1. The submission deadlines of my assignments give me ample time to focus on and fulfill each task satisfactorily.	2.75	0.86	Somewhat agree
2. The number of tasks assigned to me on different	2.6	0.85	Somewhat agree



subjects is manageable; thus, I am able to finish them on time.			
3. I can open the instructional materials in Canvas across different devices, thus enabling ease of access.	2.88	0.81	Somewhat agree
4. The different features in Canvas, such as Inbox and Chat, allows me to interact with my teachers and classmates whenever needed.	2.86	0.85	Somewhat agree
5. I am able to manage my time well for household chores and academic responsibilities.	2.25	0.85	Somewhat disagree
6. Doing household chores does not distract me or affect my performance towards academic responsibilities.	2.28	0.95	Somewhat disagree
7. My home environment is peaceful and conducive for learning, thus allowing me to study effectively.	2.18	0.82	Somewhat disagree
8. I am not distracted by the gadgets and available at home (such as television, gaming consoles, etc.), and I can focus well on my synchronous and asynchronous classes.	2.13	0.88	Somewhat disagree
Grand mean	2.49	0.86	Somewhat disagree

3.4 What strategies do the students utilize to cope with the synchronous and asynchronous learning demands?

Table 4 reveals that the students generally employ different learning strategies to make their academic lives easier, as shown by the grand mean of 2.85. The results also show that the students list academic tasks but do not join group or class review sessions. Students' preference for tracking their tasks through lists may be explained by the sense of added efficiency it causes. Most learners agree that task tracking dramatically impacts the success of their online learning experience because it helps organize responsibilities (Song et al., 2013). On the other hand, the students' lack of interest in group reviews may be caused by the perceived disadvantages from the aforementioned review style. Since the students are undergoing online classes, they might not be comfortable or feel productive when they review with others. Self-studying is more efficient than group review sessions since it offers fewer distractions and allows for the customization of learning techniques that an individual can use (Weinberger, 2020).

Table 4 *Students' Strategies to Cope with Synchronous and Asynchronous Class Set-ups*

Items	Mean	SD	Verbal interpretation
1. I am able to manage my time by using different techniques (e.g., Pomodoro method, 2-minute approach, etc.) to avoid procrastination.	2.77	0.87	Somewhat agree
2. I list all the tasks that need to be accomplished so that I'll have a smooth workflow.	3.34	0.84	Strongly agree
3. I participate in group review sessions with my classmates to reinforce my understanding of the lessons.	2.44	0.97	Somewhat disagree
4. I set aside a particular time or day dedicated to reviewing the modules and lessons for the week.	2.83	0.92	Somewhat agree
Grand mean	2.85	0.90	Somewhat agree

4. CONCLUSION

This study has attempted to examine the effectiveness of synchronous and asynchronous learning from the perceptions of students. Based on the findings of the study, it can be concluded that synchronous learning is more effective than asynchronous learning. The main factors that influence students' perceptions are the relevance of the instructional materials used and the variation in the real-time interaction during the mentioned learning set-ups. In addition, several environmental factors, including the lack of a peaceful home environment and the presence of distractions in gadgets, affect the students' online learning experience. Lastly, while the students prefer listing their tasks to have a smooth workflow, they rarely participate in group review sessions to reinforce their understanding of the lessons.

Based on these conclusions, several implications to teaching and learning in online learning environments could be drawn. First, the instructors must provide a variety of supplementary materials for the students to work with, and these materials should be understandable even without teacher supervision for synchronous and asynchronous learning to converge successfully. Second, the instructors and learners should interact more frequently during asynchronous classes to ensure knowledge retention among the latter. Third, the students must learn to adjust to the online learning environments, which they can do by finding a quieter spot in the house to be able to focus well. Fourth, they must take action to prevent gadget addiction from distracting them from studying. Fifth, different study techniques which will help the students manage their time and reinforce their learnings better should be employed.



The present study has its limitations. Future research may explore more factors affecting students' learning experience in online learning environments through a qualitative inquiry. Furthermore, research on synchronous and asynchronous learning involving teachers may provide a more comprehensive result.

5. ACKNOWLEDGMENT

The authors would like to express their sincerest thanks to the José Rizal University Senior High School Principal, Mr. Romel C. Navarro, and the Mathematics, Science, Research and Technology Department Chair, Mr. Edmundo P. Abad Jr., for their support. Special appreciation also goes to the SHS students who participated in the study and the student authors' parents for their unwavering support during the study.

6. REFERENCES

- Bonk, C. & Park, Y. J. (2007). Synchronous learning experiences: Distance and residential learners' perspectives in a blended graduate course. *Journal of Interactive Online Learning*, 6(3), 245-264. <https://eric.ed.gov/?id=EJ1092247>
- Brooks, D.C. (2011). Space matters: The impact of formal learning environments on student learning. *British Journal of Educational Technology*, 42(6), 719-726. <https://doi.org/10.1111/j.1467-8535.2010.0098.x>
- Corfman, T., & Beck, D. (2019). Case study of creativity in asynchronous online discussions. *International Journal of Educational Technology in Higher Education*. <https://doi.org/10.1186/s41239-019-0150-5>
- Dennis, A.R. & Robert, L.P. (2005). Paradox of richness: A cognitive model of media choice. *IEEE Transactions on Professional Communication*, 48(1).
- Dennon, A. (2021, February 12). Coronavirus impacts on students and online learning (Best Colleges). <https://www.bestcolleges.com/blog/coronavirus-impacts-on-students/>
- Dollonganger, C. (2020, October 29). Philippines: The rich and poor divide in distance learning. *The News Lens*. <https://international.thenewslens.com/article/142537>
- Hrastinski, S. (2008). Asynchronous and synchronous e-learning. *EDUCAUSE Quarterly*, 31(4). <https://er.educause.edu/articles/2008/11/asynchronous-and-synchronous-elearning>.
- Etikan, I., Musa, S. A., & Alkassim, R. S. (2016). Comparison of convenience sampling and purposive sampling. *American Journal of Theoretical and Applied Statistics*, 5(1), 1-4. <https://doi.org/10.11648/j.ajtas.20160501.11>
- Francesucci, H. & Rohani, G. (2018). Exclusively synchronous online (VIRI) learning: The Impact on student performance and engagement outcomes. *SAGE Journals*, 41(1), 60-69. <https://doi.org/10.1177/0273475318818864>
- Fox, W. & Bayat, M.S. (2007). A guide to managing research. Juta Publications.
- Khalil, R., Mansour, A.E., Fadda, W. A., Almisnid, K., Aldamegh, M., Al-nafeesah, A., Alkhalifah, A., Al-Wutayd, O. (2020). The sudden transition to synchronized online learning during the COVID-19 pandemic in Saudi Arabia: A qualitative study exploring medical students' perspectives. *BMC Med Educ* 20, 285 (2020). <https://doi.org/10.1186/s12909-020-02208-z>
- Kritz, I.C. (2020, June 11). PH not ready for online schooling. *The Manila Times*. <https://www.manilatimes.net/2020/06/11/campus-press/ph-not-ready-for-online-schooling/730998/>
- Malik, M., Fatima, G., Ch., A. H., Sarwar, A. (2017). E-Learning: Students' perspectives about asynchronous and synchronous resources at the higher education level. *Bulletin of Education and Research*, 39(2), 183-195. <https://files.eric.ed.gov/fulltext/EJ1210223.pdf>
- Perks, T. (2014). What makes a classroom an effective learning environment? *Light on Teaching*. <https://www.uleth.ca/teachingcentre/what-makes-classroom-effective-learning-environment>
- Peterson, A., Beymer, P. & Putnam, Ralph. (2018). Synchronous and asynchronous discussions: Effects on cooperation, belonging, and affect. 22, 7-25. <https://doi.org/10.24059/olj.v22i4.1517>.
- Sheider, J. (2021, March 3). What's the difference between asynchronous and synchronous learning? (Ohio State University). <https://online.osu.edu/resources/learn/whats-difference-between-asynchronous-and-synchronous-learning>
- Song, L., Singleton, E. S., Hill, J. R., & Koh, M. H. (2003). Improving online learning: Student perceptions of useful and challenging characteristics. *Internet and Higher Education*, 7(1), 59-70. <https://doi.org/10.1016/j.iheduc.2003.11.003>
- Weinberger, E. (2020). Self-studying vs. group studying. (Staying Ahead of the Game). <https://saotg.com/self-vs-group-studying/>



Students' Preferences on the Kinds of Online Learning Resources

Isaiah Asher S. Azcuna, Mark Israel M. Dechavez, John Henry M. Lazo
and Allen Roye S. Tulali

Lorma Colleges Senior High School, San Juan

Abstract: During this time of a pandemic, the traditional learning shifted to an online learning mode. This demands adjustments to both the teacher and the learner along with the learning resources they will utilize. The learner should be immersed in a personalized learning environment that suits the learner's personal learning needs. Knowing these learning needs will enable both the learners and the teachers to create an inclusive learning environment. One of the learning needs is the students' preferred online learning resources (OLR). There are four kinds of OLRs: texts, sounds, images/videos, and artefacts. The study aims to identify the preferences of the students on the kinds of online learning resources. Descriptive quantitative research design is the nature of this study which utilized online questionnaires to gather the data needed from the grade twelve students of LORMA Colleges Senior High School. The results show that artefacts are the most preferred OLR, followed by images/videos, texts, then sounds. Given these, the researchers created a LORMA E-Library prototype to establish a corpus of learning resources. The LORMA E-Library will enable students to have convenient and reliable access to various kinds of OLRs. The features of this LORMA E-Library are based upon the innovative environment for OLRs, which are availability, accessibility, and convenience.

Key Words: online learning; online learning resources; students' preferences

1. INTRODUCTION

1.1. Background of the Study

The COVID-19 pandemic caused a disruption in the educational sector by forcing much of the educational institutions to transition to the online learning mode of delivery to continue the educational process of the learners (Crawford et al., 2020, as cited in Tria, 2020). This is what is being considered today as the new normal mode of education and being in the online mode of delivery demands adjustments to both the teacher and the learner along with the learning resources they will utilize.

The very nature of online learning presents the need of compensation for the lack of physicality of the course materials (Amiet et al., 2017). Such needs are attained by being able to have a video conferencing between students and teachers, student to student discussions, good internet connections, lectures accessible through different digital devices, the possibility of rewatching or replaying recorded lectures, and receiving of assignments and quick feedback from teachers (Dhawan, 2020). The part where the lectures should be accessible in any gadget at any time indicates that having online learning resources (OLRs) are necessary and complementary for online learning.

Various factors act as barriers in the engagement of students in an online learning environment (Amiet et al., 2017). Two of the factors that were enumerated are poor academic performance and lack of motivation. With the given factors, it is necessary for educational institutions to help their students prepare for online learning. One of the elements comprising the readiness for online learning is the individual differences of students ([Vonderwell, 2004](#); [Watkins et al., 2004](#); [Pillay et al., 2007](#); [Mercado, 2008](#); [Dray et al., 2011](#); [Farid, 2014](#); [Wladis et al., 2016](#), as cited in Amiet et al., 2017).

Students who are engaging in an online learning mode of education often encounter lesser access with the support services the institution could offer as compared to those who are having the traditional learning (Lee, 2010, as cited in Amiet et al., 2017). The first and most important among the "four pillars" to supporting student success is all about providing students with online-friendly academic resources and student-instructor interactions (Cannady, 2015 as cited in Amiet et al., 2017).

In order to achieve this, a strong collaboration between the faculty of the institution and the institution's librarians is needed when delivering the students' OLRs ([Arnold et al., 2002](#); [Kumar & Heathcock, 2014](#), as cited in Amiet et al., 2017). If the educational instructors are not aware of the individual differences of its students, then the OLRs may not be



utilized to its full potential. Relying solely on the general resources present in the Learning Management System being utilized by the institution, especially with a lack of proper instruction, might be insufficient to fulfill the needs of the students (Kumar & Heathcock, 2014, as cited in Amiet et al., 2017).

In an international context, particularly in the United States, Bacher-Hicks et al. (2021) stated that the search intensity for learning resources received a spike after the pandemic struck. Bacher-Hicks et al. (2021) identified the top 10 most searched learning resources in the search engine Google. The following results are as follows (arranged by greatest search intensity to least): Google Classroom, Khan Academy, Kahoot, Seesaw, Schoology, ClassDojo, Flipgrid, D2L, Nearpod, and Edmodo.

In the Philippine context, the “big four” universities coped up by implementing their own Learning Management Systems to provide their students with the necessary OLRs. The “big four” universities are De La Salle University (DLSU), Ateneo de Manila University (ADMU), University of Santo Tomas (UST), and University of the Philippines (UP). For DLSU, the institution is utilizing *AnimoSpace*. For ADMU, the institution is utilizing *AteneoBlueCloud*. For UST, the institution is utilizing *UST Cloud Campus*. And UP is utilizing University Virtual Learning Environment (UVLE) and UP Open University (UPOU). Each of these institutions is implementing fully online classes, blended learning, or scheduled face-to-face classes depending on the implemented protocols of the government (Biana et al., 2020). Since these institutions are implementing various modes of learning delivery, all kinds of OLRs are being utilized.

Now that the importance of online learning resources has been settled, there are insights innovating the environment for the online learning resources. The environment for online learning resources should be capable of being shared through social networks, the environment should also be capable of housing a huge number of resources or data (in this case the online learning resources) and is compatible with a wide range of technologies. This innovative environment allows availability, accessibility, and convenience for the users in need of the online learning resources (Ahmad et al., 2018).

The research study now aims to specifically answer the question, “*What are the preferred kinds of online learning resources of the grade 12 students of LORMA?*”. Knowing their preferences will be beneficial in satisfying their individual needs in learning as the researchers will be able to create a solution on how to enable students with convenient and reliable access to OLRs.

1.2. Conceptual Framework

1.2.1. Online Learning Resources

Online learning resources are online learning contents and online learning tools obtainable in an online learning environment through the internet. The learning contents can be in the format of audio, video, or HTML documents of lectures, course objectives, tutorials, e-books, etc. As for the online learning tools, these are mind-mappings, interactive quizzes, exams, etc. (Cooper, 2009 & Lebeničnik et al., 2015). Online learning resources are important to students venturing the online mode of learning since online learning makes the learning process more student-centered and flexible resulting in a more customized learning experience (Dhawan, 2020 and Josep, 2020).

1.2.2. Kinds of Online Learning Resources

There are different kinds of OLRs which an individual can access. These are Text, Images, Sounds, Artefacts, (Moore & Kearsley, 2012 as cited by Lebeničnik et al., 2015) and Videos (Lebeničnik et al., 2015).

a.) Text

Text in the online educational domain takes the form of ‘e-text’ which is basically a collection of text-based resources for online readings which can be utilized in complement or in replacement of traditional print-based media. E-texts are continuously being incorporated with innovative functions such as outlining tools, quizzes, speech, video libraries, and the ability to share the e-text via various social media platforms (Chase, 2017).

b.) Images

Images could be still or moving (video) which is capable of implying the same meaning of several texts in a concise manner. It invokes subjective interpretation and is not bound to any language (Burns, 2020).

c.) Sounds

Sounds carry out a straightforward and associative meaning capable of evoking images and ideas that are closely related to what is being taught resulting in an efficient way of transmitting a message (Bates, 2015).

d.) Artefacts

Artefacts are the end products of teachers or students. It includes samples of students’ works, photographs, film or audio recordings of classes, documents or records which have an impact on the performances (Cope & Kalantzis, 2015).



1.3. Theoretical Framework

1.3.1. Connectivism Learning Theory

The Connectivism Learning Theory expresses that an individual learns when connections are being formed. It is not necessarily grounded on the connection between an individual to a fellow individual as it can also be found in non-human appliances. The fourth principle of the theory also emphasizes importance on the capability of acquiring further knowledge than focusing on what an individual already knows (Siemens, 2005). Therefore, in relation to the study, a student will be able to learn more when a connection is made. This further supports the importance of knowing the students' preference on the kind of online learning resources.

1.3.2. Intrinsic Motivation Theory

The Intrinsic Motivation Theory talks about the motivation of an individual to do a certain task or action out of personal interest and not being driven by external rewards (Cherry, 2019). An individual prefers having control over their own decisions as to what they would like to pursue (Lepper & Malone, 1987 as cited in Cherry, 2019).

2. METHODOLOGY

2.1 Research Design

The research study utilized Descriptive Quantitative Research Design. The aim of descriptive quantitative research studies is to be able to provide the status of one identified variable in an accurate and systematic way. This design is fitting for researchers seeking what, when, where, and how questions of a phenomenon (McCombes, 2020).

2.2 Population & Locale of the Study

The study was conducted within LORMA Colleges Senior High School in which the participants are the 12th grade students. The number of respondents was identified through random sampling. The grade 12 students were chosen to be the respondents since they are part of the transition of traditional learning to online learning. As student researchers in the 12th grade, a first-hand observation of the problem regarding online learning was observed. Thus, the researchers aim to provide a solution for the matter in a micro-to-macro manner.

2.3 Data Gathering Tools

Online survey was utilized as a platform to deliver the questionnaires. The survey includes questions pertaining to preferred kinds of online learning resources of the students. Through the survey, the researchers were able to gather

information on how to help the students access convenient, reliable, and preferred Online Learning Resources.

2.4 Data Gathering Procedures and Ethical Considerations

The researchers prioritized the needed requirements for the data gathering, in which questions were formulated for the online survey. After which, the researchers created their letters for approval and was given to the respective research advisers for validation. After the validation process, the researchers administered the survey online.

2.5 Data Analysis

For the data analysis, the gathered data were examined and question regarding what online learning resources the students prefer were tallied and shown through a graph.

3. RESULTS AND DISCUSSIONS

The study obtained ninety-seven (97) responses respectively for the online survey questionnaire that the researchers have provided. Sixty-nine (69) respondents were from the STEM - HAS strand, twenty (20) respondents were from the STEM strand, five (5) respondents were from the ABM strand, and three (3) respondents were from the ICT strand.

The researchers gathered the respondents' preferences of OLRs and are presented in the pie graph below.

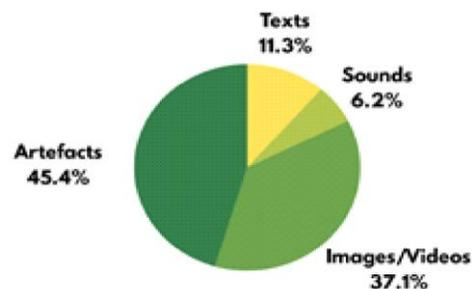

Figure 2: Students' Preferences

Artefacts were the most preferred OLR by the students gaining 44 out of the 97 responses. Mainly, convenience was the reason pointed out by the respondents since artefacts can be composed of the combination of the other 3 OLRs. This gives them the convenience of having text, sounds, and images/videos all in one learning resource. Since artefacts are the end results of students/teachers' activities then the user will have a basis on what their task is. Having a



basis is the other reason why the students preferred artefacts.

The available resources of students engaging in an online learning mode of education should be comprehensive and varying to improve the success of students (Kumar and Heathcock, 2014 as cited by Amiet et al., 2017).

Since artefacts are the past creations of students/teachers, then these artefacts can actually be combinations of other kinds of OLRs. This makes the collection of resources more varying and comprehensive which can serve as a basis for the next students on how to deal with a certain lesson or activity.

Images / Videos gained 36 responses. The major reason stated by the respondents is their learning style. Most of them stated that they were audio-visual learners. Convenience was also a major factor since the students can pause or replay the video anytime they want.

One of the aforementioned requirements of online learning stated in this study, in order to satisfy the problem about the lack of physicality, is having the possibility of replaying or rewatching recorded lectures (Dhawan, 2020). This requirement is now evidently seen within the statements of the respondents which identify images/videos as convenient because of its ability to be replayed.

Texts gained 11 responses. The major reason stated by the respondents is their learning style. There is a fraction of the total respondents who identified their learning style as a reading learner.

Sounds had the least responses having only six (6). The major reason why it had the lowest response is that most of the students stated that they can't learn effectively by just listening alone. Although the six students who chose sounds identified it as their learning style.

Putting aside the preferred OLRs of the students, when all of the reasons for their preference are taken into account, it is notable that the major reason is their learning style. Learning style is the term which describes the way an individual possesses, processes, and stores information (Chick, 2017). Plenty of learning style schemes had been devised throughout the years and the most suitable scheme for this study to relate to is the VARK learning styles. The main reason behind the relation is the reasons provided by the respondents when asked why they preferred their chosen OLR.

VARK learning style is categorized through the sensory approaches namely: Visual, Aural (Auditory), Verbal (Reading/Writing), and Kinesthetic (Chick, 2016). The identified kinds of OLRs in this study, when taken individually, actually has a corresponding learning style (i.e., Texts - Verbal, Images/Sounds - Visual, Sounds - Aural). The

respondents provided a direct link between their preferred OLR and their learning styles when they stated their reasons.

Given the identified preferred OLR of students and the established direct relationship between the preference and learning style, the researchers developed a prototype of the Lorma E-Library.

4. CONCLUSION AND RECOMMENDATIONS

The study found out that artefacts are the most preferred OLR of the grade 12 of LORMA Colleges Senior High School. Learning style is the major reason behind their preferences followed by their own convenience as the second major reason. This research paper indicated that for students to effectively engage in online learning, their individual learning needs must be achieved. This paper also indicated that relying only on the OLRs that are present in the LMS of the institution is insufficient. The findings of this study pointed out the individual learning of the students in the context of their learning styles.

Given these, the researchers came up with a LORMA E-Library, a prototype of the E-Library to establish a corpus of learning. The LORMA E-Library will enable students to have a convenient and reliable access to a variety of the different kinds of OLRs. The features of the Lorma E-Library are patterned according to the study of Ahmad et al. (2018) which provided the innovations for the environment of OLRs, these are availability, accessibility, and convenience.

As a recommendation, future researchers could conduct the study on a larger locale involving all strands of SHS and other grade levels to diversify the study.

5. ACKNOWLEDGMENTS

The researchers would like to thank Ms. Antonette Ongngad for her guidance throughout the research process. The other research advisers also provided insights that improved this study.

6. REFERENCES

- Tria, J. Z. (2020). The COVID-19 pandemic through the lens of education in the Philippines: The new normal. *International Journal of Pedagogical Development and Lifelong Learning*, 1(1), ep2001. <https://doi.org/10.30935/ijpdll/8311>
- Amiet D. L., Chung J., Garivaldis F., Holt C., Lodge J. M., McKenzie S., Mundy M. E., Roddy C., & Shaw L. (2017). Applying best practice online learning, teaching, and support to intensive online environments: An integrative review. *Frontiers in*



Education, 2(59).
<https://doi.org/10.3389/feduc.2017.00059>

Dhawan, S. (2020). Online learning: A panacea in the time of COVID-19 crisis. *Journal of Educational Technology Systems*, 49(1), 5–22.
<https://doi.org/10.1177/0047239520934018>

Berg, G. A., Boettcher, J. V., Howard, C., Justice, L., Rogers, P. L., & Schenk, K. D. (2009). Successful strategies in online courses. In L. W. Cooper (Ed.), *Encyclopedia of distance learning, second edition*. (pp. 1973-1977). IGI Global. <https://www.igi-global.com/chapter/successful-strategies-online-courses/12018>

Josep, G. (2020, June 4). *5 Reasons Why Online Learning is the Future of Education*. <https://www.educations.com/articles-and-advice/5-reasons-online-learning-is-future-of-education-17146>

Ahmad, R., Atmotiyoso, P., Basiron, B., Huda, M., Jasmi, K. A., Maselena, A., Muhamad, N. H. N., Mustari, M. I., & Siregar, M. (2018, January 22). Big Data emerging technology: Insights into innovative environment for online learning resources. *International Journal for Emerging Technology in Learning*, 13(1). <https://doi.org/10.3991/ijet.v13i01.6990>

Lebeničnik, M., Pitt, I., & Starčić, A. I. (2015). Use of online learning resources in the development of learning environments at the intersection of formal and informal learning: The student as autonomous designer. *Center for Educational Policy Studies Journal*, 5(2), 95-113. <https://eric.ed.gov/?id=EJ1128946>

Cope, B., & Kalantzis, M. (2015). *A pedagogy of multiliteracies: Learning by design* (1st ed.). Palgrave Macmillan.
<https://newlearningonline.com/learning-by-design/>

Chase, A-M. (2017, November 21). *E-texts as impactful teaching and learning tools*. ACER.
<https://www.acer.org/au/discover/article/e-texts-as-impactful-teaching-and-learning-tools>

Burns, M. (2020, July 26). *To Inform and Inspire: Images In Online Learning*. eLearning Industry.
<https://elearningindustry.com/inform-and-inspire-with-images-in-online-learning>

Bates, A. W. (2015). *Teaching in a digital age Guidelines for designing teaching and learning* (1st ed.). Tony Bates Associates Ltd.
<https://opentextbc.ca/teachinginadigitalage/chapter/9-5-2-audio/>

Siemens, G. (2005). Connectivism: A learning theory for the digital age. *International Journal of Instructional Technology and Distance Learning*, 2(1).
<https://lidtfoundations.pressbooks.com/chapter/connectivism-a-learning-theory-for-the-digital-age/>

Cherry, K. (2019, September 27). *Intrinsic motivation How your behavior is driven by internal rewards*. verywell mind. <https://www.verywellmind.com/what-is-intrinsic-motivation-2795385>

McCombes, S. (2020, September 3) *Descriptive Research Design / Definition, Methods and Examples*. Scribbr
<https://www.scribbr.com/methodology/descriptive-research/>

Bacher-Hicks, A., Goodman, J., & Mulhern, C. (2021, January). Inequality in household adaptation to schooling shocks: Covid-induced online learning engagement in real time. *Journal of Public Economics*, 193.
<https://doi.org/10.1016/j.jpubeco.2020.104345>

Chick, N. (2016). Learning Styles. Vanderbilt University
<https://cft.vanderbilt.edu/guides-sub-pages/learning-styles-preferences/>



Study Habits of LORMA Senior High School Students Engaged in Online Learning

Sophia Maureen T. Abenes, Geraldine G. Amano, Fernando Guillero O. Gamboa
James Yzedrhick G. Palmero, Elaine Angeli S. Mecos, and Alfa Ricca O. Mendoza
LORMA Colleges Senior High School, San Juan

Abstract: With the emerging paradigm shift as a result of the rise of the online learning framework during the COVID-19 pandemic, factors like study habits can change. Herewith, this study aimed to determine the study habits the LORMA Senior High School students have developed in online learning, the significant changes in the study habits before and during the implementation of online learning, and the most effective study habits of students engaged in online learning. Twenty-five (25) students were selected using simple random sampling. Qualitative-Descriptive Research Design was used which allowed the respondents to explain their perceptions in their own terms and to understand how those behaviors developed. Thematization was used in the data analysis, in which the gathered responses were categorized into various themes. The research results revealed the different study habits developed using online learning. The findings also indicated substantial differences in practices before and after the introduction of online learning. Changes in schedule and learning materials, decreased enthusiasm, and other behaviors were discovered to have changed due to the transition to online classes. Furthermore, the researchers identified four (4) most effective study habits among various responses: time management, maintaining a healthy lifestyle, concentrating, and reviewing lectures.

Key Words: study habits; online distance learning; senior high school students; COVID-19; effective habits

1. INTRODUCTION

1.1 Background of the Study

COVID-19 has reshaped the gears that once made this world work. It has caused an unprecedented crisis in all aspects of human life around the globe. The rapid increase in COVID-19 cases led to the massive closure of face-to-face classes (UNESCO, 2020). Educational institutions have initiated the momentum of continuing education amid the pandemic through different means and modalities based on available human and material resources (Paudel, 2021).

Online learning appeared to be a viable solution to fill the void for classroom education (Kasrekar & Tapaswi, 2020). The emergence of this framework opened up new learning and teaching opportunities in a variety of fields outside of the conventional classroom setting (Rodrigues et al., 2019).

As stated in a study by Aristovnik et al. (2020), the COVID-19 pandemic has had a big impact on students' practices regarding academic work and life. This highlights different situations such as the switch to online lectures, closed libraries, changed communication channels for teachers, new

assessment methods, different workloads, and performance levels. The flexibility of online learning through devices such as mobile phones can affect the implementation of new routines for learning. Rapid technological advances have encouraged institutions to concentrate their energies on improving and expanding existing educational methods.

With the emerging shift of paradigm, such as the student's mode of learning, routine, and environment, factors like study habits have a probability to alter. A study habit can be defined as an activity that students conduct frequently in order to complete the task of learning. Students need to develop appropriate studying habits to help them remain focused on their ultimate goal, which is academics (Atieno, 2019). Study habits can help them boost their self-confidence, be more competent at school, finish tasks easier, improve their ability to learn and retain knowledge, and does not put their mental health at risk (Wong, 2021).

This study obtained contextual data on the study habits of Lorma Senior High School Students and aimed to provide preferences to the future Senior High School students on the habits they can adapt to. The results of the study will also serve as a reference



material and a guide for researchers who wish to conduct the same study.

The general purpose of this study is to determine the different study habits the LORMA Senior High School students have developed in online learning and to know the significant changes before and during the implementation of online learning. Furthermore, it aims to identify the most effective study habit among the learners.

1.2 Statement of the Problem

This study seeks to answer the following questions:

1. What are the study habits of students in online distance learning?
2. What are the significant changes in the study habits of students before and during the implementation of online distance learning?
3. What are the most effective study habits of students engaged in online learning?

2. METHODOLOGY

2.1 Research Design

The researchers made use of the Qualitative-Descriptive Research design. The rationale for conducting this type of research is for the respondents to have the opportunity to describe their experiences and to have a clearer understanding of how those habits were formed.

2.2 Participants and Locale of The Study

In determining the respondents, simple random sampling was utilized. The respondents were 25 LORMA Senior High School students.

2.3 Data Gathering Tool

An online questionnaire made through Google Forms containing questions the researchers specifically seek for was sent to the respondents.

2.4 Data Gathering Procedure

A letter of permission to administer the study was sent to the School Director. After which, the researchers started to send the online questionnaire to the respondents.

2.5 Analysis of Data

In order to fulfill the objectives of this research, the responses gathered were grouped and analyzed using Thematic Analysis to achieve identifying and understanding patterns.

3. RESULTS AND DISCUSSION

3.1 Study Habits of Students in Online Learning

3.1.1 Planning ahead of time

Planning plays a vital role in the students' habit towards online learning. This includes preparing a schedule, setting up a to-do list, and prioritizing tasks. This allows students to keep track and finish all their schoolwork on or before the deadline. One student said, *"I usually list down the things that I need to do based on their due dates so that I can schedule when I will do things."* According to Joubert (2020), without a teacher regularly checking in, committing to a list or schedule is an important way to leverage one's time management skills.

3.1.2 Finding comfort in their own space

A respondent stated, *"I try to find a comfortable study place or setup."* Setting up a space for learning sharpens the mind and improves concentration. By setting a study space, students can control lighting, temperature, and etc. This can also make way for a more flexible schedule based on the students' personal preferences (Guo & Chen, 2020).

3.1.3 Building a Routine

Considering the world's current situation with the pandemic and the new normal, having a routine makes it easier for students to adopt to change and have a sense of normality (Collier, 2020). One of the respondents shared, *"After waking up, I try to have my breakfast and take a bath so that I can no longer worry about these little things."* Moreover, a routine reduces stress and provides comfort that students need in order to remain focused on their studies.

3.1.4 Note-taking

As stated in a study by Goodwin (2018), note-taking increases learning retention and organizes information. The respondents expressed that it helps them improve active listening and aids them in transforming information in ways that lead to deeper understanding. *"I always take notes whenever there is a Zoom lecture to help me concentrate. It helps me retain the topics discussed by the teacher,"* stated by one of the respondents.

3.1.5 Being Active on Online Lectures

According to Schritter (2021), active class participation allows students to focus and retain the lessons better. Respondents stated that asking questions and interacting with Zoom discussions are



the ways they stay active and fully absorb a lesson. *"I always recite and clarify through asking questions and the like,"* and *"I try my best to feed my concentration's appetite by participating and interacting with the teacher in charge & classmates for clarifications,"* are a few of the responses students have said.

3.1.6 Avoiding Distractions

Distractions are more likely to be encountered now that classes are being held virtually because of the internet, according to Morrison (2020). A student stated, *"I try to not use my phone to avoid possible distractions and to just keep my focus sharp."* Another one responded, *"if the lesson is hard or new to me, I will not respond to any messages I receive and just focus on the zoom meeting."* These statements show that avoiding distractions is a step to study effectively at home.

3.1.7 Occasionally Asking for Peers' Help

Despite the set-up where students are in their homes without their classmates by their side, technology has bridged a way for them to still communicate. *"I prefer studying alone. Although I resort to my family and friends sometimes for references or insights,"* a student stated. Asking for help benefits students' learning, bolsters student engagement, and improves better accuracy in understanding instructions and problems (Tullis & Goldstone, 2020).

3.1.8 Reviewing

Reviewing is the key for long-term learning (Nobes, 2019). Similar to what the respondents have shared, scanning and skimming their notes, and other resources can already help them retrieve knowledge from memory. *"I go over the learning materials and research for the topics that I do not understand much through the learning materials provided by the school,"* and *"I backtrack on all our lessons and take in only the important details. Mostly, I just highlight the key details on my notes,"* are two of the data that the researchers received from the respondents.

3.1.9 Consuming Online Resources

The internet has become a key resource for students due to its availability and currency (Ahmed et al., 2017). The respondents mentioned that utilizing the internet has reshaped their educational practices in terms of improving academic learning. *"I visit our google classroom for the shared artefacts & pdf files and watch YouTube videos & zoom recordings for tutorials & additional notes,"* stated by one of the respondents.

3.2 Significant Changes in the Study Habits of Students Before and During the Implementation of Online Distance Learning

3.2.1 Diminished motivation

The motivation of the students has diminished from reviewing, writing notes, and being active in class. Lack of interaction with peers and teachers is one of the reasons why students are less motivated in online classes (Meşe & Sevilen, 2021). *"We are in a home set up, I don't even look at my notes at all."* and *"got a bit less active in asking questions because mostly in a zoom meeting, students tend to be passive because of lack of interest and connectivity problems"* are some of the responses the students had inputted.

3.2.2 Change in Learning Resources

In an article, O'Loughlin (2020) mentioned that effective learning comes with appropriate tasks and teaching materials that can meet the needs of students. *"I used to write loads of notes to review but because of online classes, I developed a habit of relying on the internet for reviews and answers,"* stated by a respondent. With the change in learning resources, the students' study habits changed as well.

3.2.3 Self-Dependence

According to Moore (2021), help is not always available that is why learning to live independently is important in one's life. One respondent stated, *"I think what changed most is that I no longer can talk to my peers face-to-face, limiting our interaction,"* while in others' perspectives are *"I felt more mature depending on my own knowledge and not those what they want us to know,"* and *"It helped me to be more independent and studious."* Respondents expressed that they have become more self-dependent during online learning. Through self-dependence, students learn their own strength and not having to rely on others anymore.

3.2.4 Altered routine

"I've had to get up so early before to prepare breakfast, my school uniform, and the minutes of walk to the school, but the setup now allows me to enjoy more of my bedtime, unlike before." These are the student's experiences regarding the changes in routine. Human beings are wired to perform better if one follows a regular schedule or routine (AltaMed, 2020). In today's set-up, students have changed routine from their sleeping schedule and even to their studying hours.



3.2.5 Time efficiency

A lot has changed in the students' study habits with the sudden transition to blended learning, and this includes their time efficiency. According to Lowvelder (2018), time is a vital factor in the students' productivity. *"The way I usually recall things that need to be done was adjusted; I always keep in mind the things that I need to do from time to time,"* mentioned by a respondent.

3.2.6 Attentiveness

Some students responded that they became more attentive. According to Rose (2015), being attentive makes students be more organized and be able to store their knowledge and skills in the long run. Attentiveness helps students understand and process the information better. *"I am more active in asking questions now because there are considerably a lot of things that I don't understand or get confused with because oftentimes, a lot of things are not explained in a clear manner,"* from one of the respondents.

3.3 Most Effective Study Habits of Students Engaged in Online Learning

3.3.1 Time Management

Time management refers to a range of behavioral skills essential to the organization of study and academic load (Kaminske, 2020). The respondents mentioned that planning ahead of time, organizing their study schedule, and delegating the tasks helped them deliver work on time and achieve greater levels of productivity. *"I make a list of my schoolworks. In that way, I can assess what needs to be done first,"* expressed by one of the respondents.

Responses from the students also include the use of the Pomodoro Technique as it helps them retain the lessons and avoid procrastination. A respondent answered, *"I use pomodoro technique when reviewing because it helps me fight procrastination and it is somehow effective for me."*

3.3.2 Maintaining a healthy lifestyle

According to Helton (2017), prolonged work results in a decline in academic performances; thus, it is important to have regular breaks and proper amounts of sleep to stay focused, increase productivity, and reduce stress (Terada, 2018). *"I make sure to have a bit of rest (5-15mins) every after a task to avoid getting burned out,"* said one of the respondents. Another respondent also mentioned that they always remind themselves how they deserve a break every now and then.

3.3.3 Concentrating

This school year has been tougher than before and staying focused while studying is one of the challenges faced by the students (Dempsey, 2020). Thus, students have developed different study habits that help them with concentration. Responses from the students are as follows: *"Finding a comfortable and quiet study area," "Keeping myself alone," and "I turn off my phone's WiFi and just allot a specific time as to where I should use my phone."*

3.3.4 Reviewing Notes and Recorded Zoom Lectures

Reviewing and recalling learning resources increases students' familiarity and understanding with content. It is important due to the process of memory retrieval (Rad, 2020). One of the respondents specified that they do the 3R system: read, recall, and review. *"I download the learning materials so whenever I encounter something that has to do with the lesson and I am reminded of the concept, I check the files to verify what I remember and recall what I forgot,"* stated by another respondent.

4. CONCLUSIONS

The research results revealed the different study habits that students engaged in during online distance learning. The researchers concluded that these habits allowed students to adjust and find their own pace in the online learning set-up.

The researchers also found that there were indeed significant changes comparing the habits before and during the implementation of online distance learning. Changes in routine and learning resources, diminished motivation, and the like are habits that were revealed to have altered in the process of switching to online classes. The most effective study habits for students were also mentioned. These have helped students on absorbing and keeping up with the given lessons and activities.

The implications of this study are important in connotation to the current educational set up, in which study habits are implemented to cope with online distance learning in light of the COVID-19 pandemic.

Future researchers are recommended to evaluate a larger population of students for better results. It is essential and recommended to survey other schools for more diverse answers. They are also recommended to interview different grade levels to further understand how the study habits vary from grade levels.

5. ACKNOWLEDGEMENTS

This research is the product of a lot of hard work and motivation from those who have generously helped and guided us.



Without the help and assistance of everyone, including our parents, research adviser, and even our research colleagues, we would not have been able to complete this project.

First of all, we would like to express our gratitude to the Almighty God for always looking after us and guiding us in the right path, providing us with wisdom and knowledge in the completion of this project.

We also acknowledge our parents for their unending support, love, and care.

To our research colleagues who shared ideas, made suggestions, and also for the motivation to finish this thesis.

To our research adviser, Ms. Antonette Ongngad, who was always there for the support, guidance, and valuable comments just for us to be able to further improve our paper.

We are truly grateful for everyone who gave us the best in every way they could in order for us to finish this study.

6. REFERENCES

- Ahmed, E., Alsaaharani, S., & Ward, R. (2017). The influence of online resources on student-lecturer relationship in higher education: a comparison study. *J. Comput. Educ.* 4, 87-106 (2017). <https://doi.org/10.1007/s40692-017-0083-8>
- AltaMed Organization. (2020). Why Having a Routine During Quarantine is So Important. <https://www.altamed.org/articles/why-having-routine-during-quarantine-so-important>
- Atieno, L. (2019, June 5). Why good studying habits are important for students' success. *The New Times*. <https://www.newtimes.co.rw/lifestyle/why-good-studying-habits-are-important-students-success>
- Aristovnik, A., Keržič, D., Ravšelj, D., Tomaževič, N., & Umek, L. (2020). Impacts of the COVID-19 pandemic on life of higher education students: A global perspective. *Sustainability*, 12(20), 8438
- Collier, E. (2020). The Importance of Routine for Children: Free Weekly Planner. *High Speed Training UK*. <https://www.highspeedtraining.co.uk/hub/the-importance-of-routine-for-children/>
- Dempsey, A. (2020). How to Stay Focused While Studying, Backed by Research. [Blog site] *Freedom*. <https://freedom.to/blog/how-to-stay-focused-studying/>
- Goodwin, B. (2018, April). Research Matters / The Magic of Writing Stuff Down. *ACSD, Learning to Write, Writing to Learn*, 75(7), 78-79.
- Guo, X., & Chen, Y. (2020, July). Evaluation of Occupant Comfort and Health in Indoor Home-Based Work and Study Environment. *International Conference on Human-Computer Interaction* (pp. 480-494). Springer, Cham.
- Helton, W.S., & Russell, P.N. Rest Is Still Best: The Role of the Qualitative and Quantitative Load of Interruptions on Vigilance. *Human factors*, 59(1), 91-100. <https://doi.org/10.1177/2F0018720816683509>
- Joubert, S. (2020, March 24). How to Be a Successful Online Learner: 9 Tips & Strategies. *Northeastern University*. <https://www.northeastern.edu/bachelors-completion/news/successful-online-learning-strategies/>
- Kaminske, A. (2020). Time Management: What is it, who has it, and can you improve it? *Leaning Scientists Org*. <https://www.learningscientists.org/blog/2020/4/16-1>
- Kasrekar, D., & Wadhavane-Tapaswi, G. (2020, May 16). Impact of COVID-19 on Education System in India. *Latest Laws*. <https://www.latestlaws.com/articles/impact-of-covid-19-on-education-system-in-india/>
- Lowvelder. (2018). The advantages of time management. <https://lowvelder.co.za/424505/advantages-time-management/>
- Morrison, Ch. (2020, May). Staying Focused While Learning Remotely: How to Avoid Distractions Online. [Blog post]. <https://www.salliemae.com/blog/avoiding-distractions-online-classes/>
- Moore, C. (2021). What is Self-Reliance and How to Develop It?. *Positive Psychology*. <https://positivepsychology.com/self-reliance/>
- Nobes, R. (2019). The Importance of Regular Review for Long-Term Learning. *Impact Journal of the Chartered College of Teaching*. <https://impact.chartered.college/article/the-importance-of-regular-review-for-long-term-learning/>
- O'Loughlin, D. (2020). Selecting teaching resources that meet student needs: a guide. *ACER Discover*. <https://www.acer.org/au/discover/article/selecting-teaching-resources-that-meet-student-needs-a-guide>
- Rad, A. (2020). The importance of active recall in learning anatomy. <https://www.kenhub.com/en/library/learning-strategies/the-importance-of-active-recall-in-learning-anatomy>
- Rodrigues, H., Almeida, F., Figueiredo, V. & Lopes, S.L. (2019). Tracking e-learning through published papers: A systematic review. *Computers & Education*, 136(1), 87-98. <http://dx.doi.org/10.1016/j.compedu.2019.03.007>
- Rose, M. (2015). Why Attention Is Essential To Learning And The Formation Of Memory. *eLearning Industry*. <https://elearningindustry.com/attention-essential-learning-formation-memory>
- Schritter, T. (2021). How to Participate in Class and Why it's Important. *College of Distinction*. <https://collegesofdistinction.com/advice/how-to-participate-in-class-and-why-its-important/>
- Tullis, J. G., & Goldstone, R. L. (2020). Why does peer instruction benefit student learning?. *Cognitive research: principles and implications*, 5, 1-12.
- United Nations Educational, Scientific and Cultural Organization. (2020). Education: From disruption to recovery. *UNESCO*. <https://en.unesco.org/covid19/educationresponse>
- Wong, D. (2021, January 16). 22 Study Habits That Guarantee Good Grades. *Daniel Wong*. <https://www.daniel-wong.com/2019/07/30/study-habits/>



The Perceptions of Incoming College Students from One of the Universities of the South on the Use of Biomimicry as a Method in the Field of Engineering

John Christopher Y. Boctot, Kyle M. Delos Santos, Daniel Felicisimo S. Mangundayao III
Stephen Benjamin A. Siy, and Christian Benjamin B. So
University of Perpetual Help System DALTA, Las Piñas City

Abstract: Biomimicry is a growing concept in science. Technologies that are developed nowadays are influenced by thorough studies on the structure and function of plants and animals. To bring innovative ideas that came from nature's own adaptation and apply this to the principles of engineering, the study aimed to gauge and understand the level of perception of incoming Engineering students towards the process and engineering of biomimetics technologies. It determined the level of knowledge of the respondents with regards to the utilization of biomimicry in the modern setting. The researchers used a descriptive quantitative survey research design to measure the awareness or perception of the respondents. The researchers also made use of a researcher-made questionnaire for the collection of data and applied the 4-point Likert scale. The respondents of this study are the Grade 12 STEM students of the University of Perpetual Help System DALTA. The study utilized the statistical tools of frequency, percentage, and weighted mean in interpreting the perception of the respondents. The results of the study showed that majority of the respondents are aware to more famous inventions/concepts inspired by biomimicry such as the Bullet Train and photosynthetic ability of plants. After analyzing the results, the researchers conclude that the respondents are aware of the modern the designs and concepts of biomimicry making way for professionals to apply biomimicry in the future. In addition, the results of this study provided the researchers insights for future reference and engineering designs.

Key Words: biomimetics, biomimicry, engineering methodology, perceptions, sustainability

1. INTRODUCTION

Biomimicry is the term to describe the design process of Biomimetics, the study that deals with observing and examining the functions of living organisms as models for creating products and inventions to benefit human society. The term 'biomimetics' was coined by Dr. Otto Herbert Schmitt, an American biophysicist, in 1957 after developing a device that mimicked the electrical reactions of human nerves. The field is focused on understanding and application of biological functions of living organisms to be used with engineering to develop commercial devices (Bhushan, 2009). Biomimetics comes from the Latin words: *bios*, meaning "life," and *mimesis* meaning "to imitate" (2020). Biomimetics is similar to Bionics, (Muderis & Ridgewell, 2016). Glaser et al., (2013) illustrates that biomimicry is not the literal replicating of these functions as there are limitations and consequences, rather it is a process of selective learning

Benyus (1997) popularized the term "biomimicry" with her book, "*Biomimicry: Innovation Inspired by Nature*". Benyus discussed nature as

having three importance to the method of biomimicry, these being: (1) Nature as a Model; (2) a Measure; and (3) a Mentor.

These signify the inspiration of man to replicate nature's biological processes and incorporate it to society. Biomimicry is seen in the world of architecture and engineering as it functions as a methodology in the field when creating infrastructures to suit society's needs. One example is the Japanese Bullet Train in 1964. The bullet train took inspiration from the kingfisher's pointed narrow beak which allows it to gracefully dive into the water without much disruption. The bullet trains achieved this structure through creating a smoother and "pointed" design for its front to reduce the sonic boom it causes when going through tunnels. A historical instance were the sketches created by Italian polymath, Leonardo da Vinci. His sketches of the Ornithopter took innovation from the flapping motion of a bird's wings which allowed them to lift from the ground with their hollow skeletal structures.

Sustainable usages of biomimicry were adapted to counteract the adverse effects of the industrial age. The use of the humpback whales'



tubercles reduces stall caused by underwater movement to increase speed when travelling through fluids. When employed in wind turbines, the same effect is found. A study conducted by Fish et al. (2011) explored the usage of tubercles in wind turbines and found the use of tubercle-lead blades produced higher performance in generating electricity while maintaining stability as opposed to smooth-lead blades.

There is Philippines has less utilization of biomimetics, causing a need for sustainability. Romolo Nati, CEO of Italpinas, pointed out that there is a great imbalance in the use of resources as many have the misconception that natural resources are infinite and continue to abuse these (2014). Similarly, Nati (2013) emphasized the need to switch to an eco-friendlier method of infrastructure by applying biomimetics methods. Stating that cities occupy 2% of landmass, but produce 70% of green-gas-emissions, he asserted that there is need to have a sustainable solution by employing sustainable development tools through biomimicry and performance-based strategies.

This study aimed to know the perceptions of incoming engineering students towards biomimicry. The study sought to determine the knowledge regarding biomimicry in products for improvement in a person’s lifestyle through use of a survey questionnaire to obtain fixed responses from the respondents.

The study determined the perceptions of incoming Engineering students on the use of biomimicry as a methodology. Specifically, the study obtained the following details through the questions: First, the respondents’ profile: age, sex, and previous academic performance. Second, the respondents’ level of perception to biomimicry designs as to structure and biological function of plants and animals. Third, the level of perception of respondents as to the inventions using biomimetics. Lastly, insights to be drawn by the researchers from the results.

2. METHODOLOGY

2.1. Data Gathering Tool

The study made use of the research-made questionnaire for data-gathering. The research questionnaire was floated to the respondents, Grade 12 STEM Students, who will be taking engineering courses, through an online setting.

The researcher-made questionnaire was in two parts. The first part presented the profile data of the respondents, their age, sex, and previous academic performance. The second part of the questionnaire determined the perception of respondents as to biomimicry designs.

It determined the level of perception of the respondents to the structure and biological function of plants and animals and inventions that used biomimicry designs.

Table 1. Interpretation Scale

Scale	Limits	Verbal Interpretation	Word Description
4	3.50-4.00	Strongly Aware	The respondents are fully aware and are familiar on the use of Biomimicry as a methodology in the field of engineering as well as the functionality it has on everyday technology
3	2.50-3.49	Aware	The respondents are aware and are somewhat familiar with the use of biomimicry as a method in engineering and its use on some devices.
2	1.50-2.49	Unaware	The respondents have little knowledge on the use of biomimicry as a method in the field of engineering.
1	1.00-1.49	Strongly Unaware	The respondents have no knowledge or have only known of biomimicry as a method in the field of engineering

Table 1, shows the interpretation scale. It used a statistical trait using Microsoft Excel-generated interval of 3.5-4, which has the highest scale of 4, and has a verbal interpretation of “Strongly Aware”. Followed is the interval of 2.5–3.49, with a rating scale of 3, and a verbal interpretation of “aware”. The statistical trait of 1.5-2.49, follows with an equivalent scale rate of 2, and a verbal interpretation of “Unaware”. Last is the statistical trait of 1–1.49, with the lowest scale of 1, and a verbal interpretation of “strongly unaware”.

2.2. Population and Sampling Design

The study solicited data from Grade 12 students enrolled in the STEM strand focused in the engineering course of the University. There are nine (9) sections comprising the STEM strand composed of forty (40) students each. Five (5) of those sections are composed of students who will be taking Engineering programs. Four (4) of these sections were the sources of the respondents.

Purposive sampling was utilized as it was deemed appropriate by the researchers to have respondents who may be familiar with a topic of biomimetics in engineering. Purposive sampling is a non-probability method of gathering a sample which, according to Black, K. (2010), occurs when “*elements selected for the sample are chosen by the judgment of the researchers*”. The selection of respondents is based on their knowledge and expertise towards a certain topic, or concept (Robina, 2014). This form of sampling is accomplished through logical assumptions and expert knowledge of a given population, elements are selected nonrandomly from the population (Lavrakas, 2008).

For the population, the study utilized selected Grade 12 students from the University of Perpetual Help System-DALTA, Las Piñas Campus currently in the STEM strand focused on engineering. It included respondents who were willing to participate in the study.



2.3. Data Gathering Procedure

The study utilized a descriptive quantitative design, the Descriptive Survey research design. A descriptive quantitative research measures the subjects in question and finds the association between the chosen independent and dependent variables (Hopkins, 2000). This is due to the study gathering data from the perceptions of respondents towards biomimicry as a methodology in engineering. Creswell (2003) states that quantitative research design “*employs strategies of inquiry such as experiments and surveys, and collect data on predetermined instruments that yield statistics data*”.

The Descriptive Research design is used when researchers’ goal is to measure the behavior and characteristics of a sample (Dudovskiy, 2011). This research design answers what, where, when, and how (McCombes, 2020) through observation and descriptive analysis with instruments such as surveys (Koh & Owen, 2000).

Uses of descriptive-surveys are to find the “*range and distribution*” of the demographic or psychographics of individuals to see if there is any relation of it to behavior patterns and/or attitudes (Zurmuehlen, 1981). The Descriptive Survey Research design was utilized in the study to investigate the awareness of the respondents towards biomimicry as an engineering methodology.

The first phase was the formulation and validation of research made questionnaire. The researchers formulated the research questionnaire and have it verified through experts. Second, writing a letter to the administrators of the Senior High School Department to ask for permission and approval to conduct a study. Lastly, distribution of the questionnaire, wherein the researchers sought the consent of the respondents before distributing the questionnaire. The respondents were given one week to answer the distributed questionnaire. The researchers collected the questionnaire and interpreted the data through 4-point Likert scale.

2.4. Data Analysis Plan

The researchers analyzed and interpreted the data after collation. In analyzing the data, the researchers used statistical treatment. They used statistical tools of percentage, frequency and weighted mean. After getting the weighted mean, the researchers analyzed the data based on the Likert scale formulated by the researchers. The last part was the interpretation of the data.

3. RESULTS AND DISCUSSION

Table 2. Profile of respondents as to Age

Corresponding Age	Frequency (f)	Percentage (%)
17	21	20.6
18	67	65.7
19	11	10.8
20 and above	3	2.9
Total	102	100

From Table 2, it could be gleaned that majority of the respondents, sixty-seven (67) or sixty-five and seven tenths (65.7 %) are aged eighteen (18).

It can be said that most of the respondents falls on the age of eighteen as this is the typical age of Filipinos who are enrolled in the grade 12 program.

Table 3. Profile of respondents as to Sex

Sex	Frequency (f)	Percentage (%)
Male	63	61.8
Female	39	38.2
Total	102	100

From Table 3 it can be derived that more than half of the respondents’ sex is male with a frequency of sixty-three (63) or a percentage of sixty-one and eight tenths (61.8 %).

This is due to the preference of male students to enroll in engineering programs. As the chosen locale of the study is in the engineering STEM strand, this has been the case.

Table 4. Profile of respondents as to Previous Academic Performance

Grade	Frequency (f)	Percentage (%)
93-95	20	20
90-92	29	28
87-89	31	30
84-86	15	15
81-83	6	6
75-77	1	1
Total	102	100

From Table 4, it can be extracted that majority of the respondents, thirty-one (31) respondents, a percentage of thirty (30%), have their previous academic performance to be in the range of 87-89.

It is inferred that majority of the respondents have above average academic performance in the sciences and mathematics.



Table 5.
 Perception of respondents as to biomimicry designs as to structure of plants and animals.

Indicator	Weighted mean	Verbal interpretation	Word Description
1. I am aware that the improved blades of wind turbines are based on the fin structure of humpback whales	2.37	Unaware	The respondents have little knowledge on the use of biomimicry as a method in the field of engineering.
2. I am aware that the modern Japanese bullet train's front nose design to the beak of a Kingfisher bird.	2.64	Aware	The respondents are aware and are somewhat familiar with the use of biomimicry as a method in engineering and its use on some devices.
3. I am aware that a commercial building in Melbourne, Australia, Council House 2, utilizes design strategies of termite mounds for natural cooling	2.36	Unaware	The respondents have little knowledge on the use of biomimicry as a method in the field of engineering.
4. I am aware that inspiration for Velcro were burdock burrs hooked-spikes that are able to latch onto objects	2.30	Unaware	The respondents have little knowledge on the use of biomimicry as a method in the field of engineering.
5. I am aware that the spandex swim suits are inspired on the hydrophobic nature of shark skins.	2.62	Aware	The respondents are aware and are somewhat familiar with the use of biomimicry as a method in engineering and its use on some devices.
Average	2.46	Unaware	The respondents have little knowledge on the use of biomimicry as a method in the field of engineering.

Table 5 presented the perception of respondents as to biomimicry designs on the structure of plants and animals. Indicator 2 has the highest weighted mean of two and sixty-four hundredths (2.64) with a verbal interpretation of "Aware". While Indicator 4 has the lowest weighted mean of two and three tenths (2.3) with a verbal interpretation of "unaware". Results of table 5 show the respondents' weighted average is two and forty-six hundredths (2.46) with a verbal interpretation of "Unaware".

Table 5.1.
 Perception of respondents as to biomimicry designs as to biological function of plants and animals

Indicator	Weighted mean	Verbal interpretation	Word Description
1. I am aware that the solar cells were inspired by the process of photosynthesis by the leaves.	3.29	Aware	The respondents are aware and are somewhat familiar with the use of biomimicry as a method in engineering and its use on some devices.
2. I am aware that the bird wing inspired aircraft to aid in aerodynamics.	3.19	Aware	The respondents are aware and are somewhat familiar with the use of biomimicry as a method in engineering and its use on some devices.
3. I am aware that the biological function and structure of a firefly's bulb is the inspiration for the efficiency found in LED Light Bulbs	2.79	Aware	The respondents are aware and are somewhat familiar with the use of biomimicry as a method in engineering and its use on some devices.
4. I am aware that tubercle-lead blades produced higher performance in generating electricity for wind turbines	2.62	Aware	The respondents are aware and are somewhat familiar with the use of biomimicry as a method in engineering and its use on some devices.
5. I am aware that the flapping motion of birds to gather lift is inspiration for how helicopters increase lift	2.74	Aware	The respondents are aware and are somewhat familiar with the use of biomimicry as a method in engineering and its use on some devices.
Average	2.93	Aware	The respondents are aware and are somewhat familiar with the use of biomimicry as a method in engineering and its use on some devices.

Table 5.1 presented the perception of the respondents towards biomimicry designs as to the

biological function of plants and animals. Indicator 1 having the highest weighted mean of three and twenty-nine hundredths (3.29) with a verbal interpretation of "Aware". While

Indicator 4 has the lowest weighted mean of two and sixty-two hundredths (2.62) with a verbal interpretation of "Aware". Results of table 2.3 show the respondents' weighted average of two and ninety-three hundredths (2.93) with a verbal interpretation of "Aware".

Table 6. Perception of respondents as to inventions using biomimicry designs

Indicator	Weighted mean	Verbal interpretation	Word Description
1. I am aware that the Japanese bullet train's front nose is based on the narrow beak of the kingfisher bird to maximize speed and lessen noise pollution.	2.73	Aware	The respondents are aware and are somewhat familiar with the use of biomimicry as a method in engineering and its use on some devices.
2. I am aware that the solar cells are based on the photosynthetic ability of plants in producing energy from light-energy sources	3.08	Aware	The respondents are aware and are somewhat familiar with the use of biomimicry as a method in engineering and its use on some devices.
3. I am aware that the second council house in Melbourne, Australia was based on termite mounds for temperature regulation	2.25	Unaware	The respondents have little knowledge on the use of biomimicry as a method in the field of engineering.
4. I am aware that the improvement of structure in wind turbines increases efficiency in generating electricity	2.88	Aware	The respondents are aware and are somewhat familiar with the use of biomimicry as a method in engineering and its use on some devices.
5. I am aware that the American B2 Spirit Bomber was based on the ability of hawks to maintain aerodynamic speed and mobility through having a packed body.	2.3	Unaware	The respondents have little knowledge on the use of biomimicry as a method in the field of engineering.
Average	2.66	Aware	The respondents are aware and are somewhat familiar with the use of biomimicry as a method in engineering and its use on some devices.

As seen on Table 6, Indicator 2 has the highest weighted mean of three and eight hundredths (3.08) with a verbal interpretation of "Aware". While Indicator 3 has the lowest weighted mean of two and twenty-five hundredths (2.25) with a verbal interpretation of "unaware". Results of table 6, the respondent's weighted average is two and sixty-six hundredths (2.66) with a verbal interpretation of "Aware".

4. INSIGHTS DRAWN BY THE RESEARCHERS

According to the data, the respondents of the study were most aware of the designs inspired by the biological functions of nature. This may be due to the curriculum of the respondents surveyed, as students who took science classes with biological concepts. Results show that the students were more aware of the design, function, and inspiration which created



the Bullet Train and Council House 2 from Melbourne, Australia.

The biomimetic technologies with the highest weighted mean are what the respondents are most aware of due to the commonality of these inventions in their life to counteract effects of industrial-based technologies.

Likewise, the researchers are able to gauge the level of perception the respondents have regarding the topic of Biomimicry. The results gave insights towards the things that should be implemented to suffice the lack of knowledge that is essential in pursuing engineering. It signifies the pursuit of the implementation of biomimetics research in the future engineering programs the researchers will be enrolling in. Some of these inventions are not widely used in modern homes. Factors to consider are previous academic experiences regarding the topics such as photosynthesis and aerodynamics.

4.1. Summary of the Findings

Majority of the respondents of the study are within the age range of 17 to 18 years of age. Most of them are males and their previous academic performance, above average. As to perception to the structure of biomimicry inventions, majority of the respondents are aware that the Bullet Train was inspired by the kingfisher bird, which has the highest weighted mean. As to the biological function as to plants and animals, majority of the respondents are aware that the photosynthetic ability of leaves became the inspiration in the creation of solar cells. As to the perception as to inventions using biomimicry designs, majority of the respondents are aware of solar cells inspired from the photosynthetic ability of plants to create energy from solar-light. The researchers were able to come up with the insights based on the results of the study. These insights include the importance on the use of biomimicry design and how it will play in pursuing future careers.

4.2. Conclusions of the Study

Based on the findings of the study, the following conclusions are drawn:

Most of the respondents are within the age range of 17 – 18 years of age. Majority who are taking Engineering focus stem strand are males and have grades of above average and excelled in the fields of Science and Mathematics. Most of the respondents are aware on the existence of the bullet train and solar cells. Since these technologies are well-marketed and being used for convenience in transportation and electricity-generation. Majority of the respondents are aware of photosynthesis being the inspiration for the invention of solar cells to generate electricity from the

sun's solar-light. From the increase of efficient and sustainable power-generating from the use of solar cells, most of the respondents are familiar of the existence of these technologies. The researchers adhere to the conclusion that most of the respondents are aware that some modern technologies are products of biomimicry design and concept. These insights gleaned by the researchers from the study provide a wider perspective in designing future technologies by studying the structure and function of plants and animals. Furthermore, through the data gathered, these inspired the researchers to make more in-depth studies about biomimicry.

4.3. Recommendations

Based on the findings and conclusions drawn from the study, the following recommendations are hereby made:

There should be a follow-up study on biomimetics for efficiency in household chores. Future studies must involve a larger range of respondents of a specific engineering field that may utilize biomimetics in the future. The Department of Science and Technology (DOST) must allocate funding for researches for biomimicry designs. Likewise, the Commission-on-Higher Education (CHED) and Department of Education (DepEd) must include in the STEM and Engineering curriculum the designing of technologies using biomimetics. Engineering companies should invest on biomimetics research, through the study of the structure and biological function of organisms to mitigate pollutants produced by modern machinery. Engineering schools may consider in creating or drafting a curriculum prioritizing technologies that follow biomimicry designs that would be sustainable. The study made use of respondents from the engineering-focused field of the STEM Strand. Future studies may include biology-based fields in order to increase depth of the study on the perception of respondents towards biomimetics.

5. ACKNOWLEDGEMENTS

The researchers of this study would want to acknowledge with great appreciation the people who have given their time and effort for the creation and conclusion of this study.

First of all, to their families and guardians for providing the researchers their needs and support for the entire study as well as their continuing support in the education of the researchers Secondly, to their alma mater, the University of Perpetual Help System DALTA, and to

their thesis adviser, Mr. Wilfred Glenn Tirol Catud, for allowing them the opportunity and push to conduct this study. As well as his effort, patience, and time in the duration of the study.



Third, to one of the professors from the College of Education of the University of Perpetual Help System DALTA, Dr. Benjamin C. Siy Jr., for his unending support, guidance, patience, and support in the creation of this study.

Fourth, to the respondents who were willing to participate in this study and provide their data to finalize the study.

And lastly, to the fellow researchers for bestowing their continuous time and effort in making this study possible.

6. REFERENCES

- Benyus, J. M. (1997). *Biomimicry: Innovation Inspired by Nature*. Harper Collins.
- Bhushan, B. (2009, April 28). *Biomimetics: lessons from nature—an overview*. Retrieved from Royal Society Publishing: <https://royalsocietypublishing.org/doi/10.1098/rsta.2009.0011>
- Black, K. (2010). *Business Statistics: Contemporary Decision Making 6th Edition with WileyPLUS Set Wiley Plus Products*. John Wiley & Sons, Inc.
- Creswell, J. W. (2003). *RESEARCH DESIGN: Qualitative, Quantitative, and mixed methods approaches second edition*. In J. W. Creswell, *RESEARCH DESIGN: Qualitative, Quantitative, and mixed methods approaches second edition* (p. 21). SAGE Publications.
- Dudovskiy, J. (2011, 11 7). *Descriptive Research*. Retrieved from Business Research Methodology: https://research-methodology.net/descriptive-research/#_ftn1
- Editors, E. E. (2020, October 11). *What is Biomimicry?* Retrieved from Environment and Ecology: <http://environment-ecology.com/biomimicry-bioneers/367-what-is-biomimicry.html#:~:text=The%20term%20biomimicry%20and%20biomimetics,and%20mimesis%2C%20meaning%20to%20imitate>
- Fish, F. E., Murray, M. M., Weber, P. W., & Howle, L. E. (2011, May). *The Tubercles on Humpback Whales' Flippers: Application of Bio-Inspired Technology*. Retrieved from Research Gate: https://www.researchgate.net/publication/51130456_The_Tubercles_on_Humpback_Whales'_Flippers_Application_of_Bio-Inspired_Technology
- Glaser, D. E., & Viney, C. (2013). Chapter I.2.18 - Biomimetic Materials. In B. D. Ratner, F. S. Schoen, A. S. Hoffman, & J. E. Lemons, *Biomaterial Science (Third Science)* (p. 349). Academic Press. Retrieved from Science Direct.
- Hopkins, W. G. (2000, May 4). *Quantitative Research Design*. Retrieved from Sports Science: <https://www.sportsci.org/jour/0001/wghdesign.html#:~:text=Quantitative%20research%20designs%20are%20either,establishes%20only%20associations%20between%20variables.&text=In%20an%20unblinded%20experiment%2C%20such,magnitude%20of%20any%20placebo%20effect>
- Italpinas. (2014, August 7). *New Biomimicry concept in building design inspired by nature*. Retrieved from Architecture and Design: <https://www.architectureanddesign.com.au/news/infolink/new-biomimicry-concept-in-building-design-inspired>
- Koh, E. T., & Owen, W. L. (2000). *Descriptive Research and Qualitative Research*. In E. T. Koh, & W. L. Owen, *Descriptive Research and Qualitative Research*. In: *Introduction to Nutrition and Health Research* (pp. 219-248). Springer, Boston, MA. Retrieved from SpringerLink.
- Lavrakas, P. J. (2008). *Encyclopedia of Survey Research Methods*. Sage publishin.
- McCombes, S. (2020, September 3). *Descriptive research*. Retrieved from Scribbr: <https://www.scribbr.com/methodology/descriptive-research/#:~:text=Descriptive%20research%20aims%20to%20accurately,investigate%20one%20or%20more%20variables>
- Muderis, M. A., & Ridgewell, E. (2016, February 11). *Bionic limbs*. Retrieved from Australian Academy of Science: <https://www.science.org.au/curious/people-medicine/bionic-limbs>
- Residences, P. (2013, November 26). *Green building expert ITPI to builders: adopt 'biomimicry' to build smarter, sustainable cities*. Retrieved from Primavera Residences: <https://primaveraresidences.italpinas.com/green-building-expert-itpi-to-builders-to-build-sustainable-and-smarter-cities-adopt-biomimicry/>
- Robina, R. S. (2014). *urposive Sampling*. In: Michalos A.C. (eds) *Encyclopedia of Quality of Life and Well-Being Research*. Springer.
- Zurmuehlen, M. (1981). *Descriptive Survey*. Marilyn Zurmuehlin Working Papers in Art Education 1, 54-63.



Aspects Contributing to the Underemployment of the Top 3 Fields of Engineering in Las Piñas City, and Muntinlupa City

Maria Jeriah V. Canta, Julian Lorenz M. Cruz, Rhoysce Anne M. Latoza,
Princess Nicole P. Lim, and Johnry E. Quillope
St. Edward School, General Trias City, Cavite

Abstract: Up to this day, underemployment continuously becomes a significant contributor to poverty, and it happens to any other industry, including the engineering industry. As an attempt to contribute to the body of knowledge regarding underemployment, this study investigated the leading causes of underemployment in engineers at Las Piñas City and Muntinlupa City. The study used an online survey questionnaire with non-probability sampling to collect the necessary data from various licensed engineers. Descriptive statistics was the data analysis method of the study. The results indicate that the leading causes of underemployment in different engineering fields are lack of experience, limited job opportunities, many competitions, and the substandard education system. Mechanical Engineering, Electronics Engineering, and Electrical Engineering are the top three engineering fields that often experience underemployment. The study concluded that experience is highly needed to attain employment in the engineering industry.

Key Words: underemployment; engineering fields; Las Piñas city; Muntinlupa city; college programs

1. INTRODUCTION

The Field of Engineering has been a respected industry since the 1500s. It is one of the significant components of the civilization of the human race. However, despite engineering being vital to the continuity of civilization and the tremendous number of people who choose to take engineering as their college program, the engineering industry still suffers from underemployment, just as engineers are underemployed. It still experiences underemployment just like other career fields. According to Chen (2020), underemployment is “a measure of employment and labor utilization in the economy that looks at how well the labor force is being utilized in terms of skills, experience, and availability to work.”

There are two types of underemployment, namely: visible underemployment and invisible underemployment. Amadeo (2020) states that visible underemployment includes employees who are working fewer hours than is typical in their field. They are usually the ones who work part-time jobs. On the other hand, invisible underemployment includes workers in full-time jobs that do not use all their skills (Amadeo, 2020).

In the United States, the U.S. Bureau of Labor Statistics (BLS) prepares employment growth for 18 engineering occupations in the year 2016-2026, with Civil Engineering being the largest

engineering occupation, followed by Mechanical Engineering and Industrial Engineering. Likewise, the engineering industry is thriving in Australia. The 2018 Graduate Outcomes Survey (GOS) report stated that engineering graduates have above-average employment outcomes, with a full-time employment rate of 83.1% in 2018. In addition to this, 71.9% are categorized as “professionals.” According to the survey, civil engineers had the highest chances of having full-time employment with a percentage of 88.2%, followed by Electrical, and Electronics Engineers (85.5%). Despite these enticing figures, it is still uncertain whether an individual will fall under the desirable 83.1% or the remaining 16.9%. Brown (2019) stated that it is also not a guarantee that an engineering degree means an engineering-related job.

This research study principally focused on the aspects contributing to the underemployment of different engineering fields in Las Piñas and Muntinlupa City. Specifically, the researchers hope to address the main causes of underemployment of engineers in the Las Piñas and Muntinlupa City and the reasons resulting from these causes, as well as the engineering branches that often experience underemployment. Students, engineering students, government and engineering sectors, and future researchers may benefit from this study.



2. METHODOLOGY

2.1. Data Gathering Tool

According to Bhat (2020), “survey is a research method used for collecting data from a predefined group of respondents to gain information and insights into various topics of interest.” The researchers used an online survey questionnaire to collect the data. The survey was divided into three parts namely: the respondent’s profile, semi-structured questionnaire, and a 5-point Likert scale. This questionnaire was distributed through Google Forms to different licensed engineers, who are the principal respondents of the study.

The researchers also used a Likert scale with given criteria of 4 strongly agreeing, 3 agreeing, 2 being disagreed, and 1 strongly disagreeing. Using the data collection tools, the researchers conducted their research using semi-structured questionnaires.

Before commencing the actual data collection, the researchers conducted a pilot testing where the mock respondents were students of Grade 12 STEM (engineering sections). The researchers conducted pilot testing to detect major and/or minor errors that may have been overlooked by the researchers. The researchers evaluated the time it took for a mock respondent to answer the whole survey, the data collection method, survey strategy, and the general aspects of the survey to further improve it.

2.2. Sampling Design

Purposive sampling and Snowball sampling were the chosen sampling designs for this study. Purposive sampling is believed to be the most suitable sampling design for this study, as the attributes that the researchers were looking for from the respondents were very specific. Through this, the researchers handpicked the participants who fit the specified criteria, that being: (1) a Filipino citizen of any age and gender, (2) a graduate of any engineering degree in the Philippines, (3) an engineering graduate that is residing and/or working in Las Piñas City or Muntinlupa City, and (4) a licensed engineer. After utilizing the Purposive Sampling, the participants referred to other people, who also fit with the given criteria, and were invited to be respondents of the study (Snowball Sampling).

2.3. Data Gathering Procedure

The researchers underwent three stages of data gathering procedure. The first stage is the preparation of the survey questionnaire, as well as the arrangement of proper credentials (i.e.,

acquisition of consent). The second stage is the distribution of the survey questionnaire to the respondents, and the last one is the collection and interpretation of the gathered data. Each stage entails different processes to fulfill the data gathering procedure.

2.4. Data Analysis Plan

The researchers used descriptive statistics as their data analysis method to analyze and provide the results in the survey data. The percentage and weighted mean were presented using pie charts to present the data under research questions 1 and 2, while bar chart for research sub-question a.

Formula of Percentage

$$\% = f/N \times 100$$

$$\% = \text{Percent}$$

$$f = \text{Frequency}$$

$$N = \text{Total number of respondents}$$

FORMULA OF WEIGHTED MEAN

$$\bar{x} = \frac{\sum_{i=1}^n W_i \cdot X_i}{\sum_{i=1}^n W_i} = \frac{W_1 X_1 + W_2 X_2 + \dots + W_n X_n}{W_1 + W_2 + \dots + W_n}$$

Where \bar{x} = Weighted Mean

w = weight

x = frequency

The formula of percentage was used to analyze the collected data under research question number 1 and 2, while the formula of the weighted mean was used to interpret the degree of agreement or disagreement of a respondent, used under research sub-question a.

3. RESULTS AND DISCUSSION

3.1. Leading causes of underemployment of engineers in Las Piñas City and Muntinlupa City

With the set of data collected, the results have shown that the leading cause of underemployment of engineers in Las Piñas City and Muntinlupa City is lack of experience, with a



percentage of 40%. Followed by limited job opportunities, many competitions, and a substandard education system. This indicates that experience is the utmost priority in the engineering industry. Meaning more experience, more chances of being employed.

Figure 1. Leading Causes of Underemployment of Engineers in Las Piñas City and Muntinlupa City

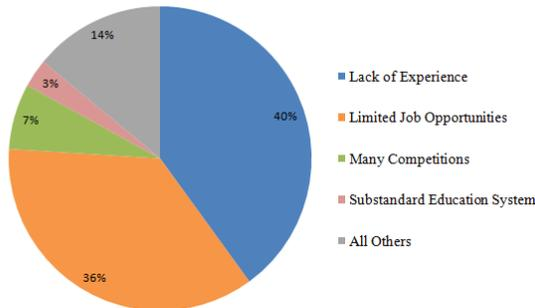

Table 1. Gender as a Factor of Underemployment (n = 65)

Response	Gender		
	Male	Female	Prefer not to say
Yes	19	3	1
No	34	8	0
Total	53	11	1

Table 1 shows the number of respondents who confirmed that they have experienced underemployment. Out of 65 respondents, 23 of them experienced underemployment—19 males, 3 females, and 1 who preferred not to say their gender. The engineering industry seems to be perceived as a male-dominated field; such notion can be also observed from the number of female respondents of the study. Despite this, the percentages of those who experienced underemployment per gender oppose that the engineering industry is more favorable to the male gender. The rate of female underemployment was juxtaposed with the percentage of male underemployment and as a result, male underemployment is higher, with a percentage of 35.48%, than the rate of female underemployment, which is 27.27%.

Table 2. Age as a Factor of Underemployment

Field of Engineering	Age (in years)					Total Column
	21-30	31-40	41-50	51-60	61-70	
Mechanical	6	1	1	1	1	10
Electronics	4	1	0	0	0	5
Electrical	0	1	1	1	0	3
Civil	2	0	0	0	0	2
Computer	2	0	0	0	0	2
Materials	1	0	0	0	0	1
Total Row	15	3	2	2	1	23

As shown in Table 2, most of the engineers who are under the age bracket of 21-30 years old confirmed that they have experienced underemployment. This age bracket is most likely to be prone to underemployment as most of them are fresh graduates who, more often than not, lack work experience. Some on the other hand are not qualified for the job description needed by companies. These results show that engineers from ages 31 and above do not often experience underemployment and have stable jobs in their respective fields.

Some respondents have also specified other reasons for underemployment. Prominent responses included, “few engineering positions required in the industry”, “lack of specialization offering”, “cyclic condition of oil and gas industry which impacts the requirement of manpower in hire and release”, and “low paying companies that results to low salary.”

3.1.1. Reasons resulting from these causes

Figure 2. Weighted Means of the Data for Sub-Question A

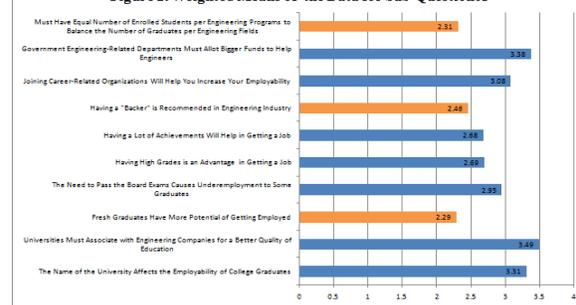

The respondents were also asked to scale their agreeance in a statement in which each statement is also linked and aligned to the reasons that result in the aforementioned causes of underemployment. Figure 2 from the previous page shows the weighted means of their responses.



3.1.1.1. *Reasons that result to lack of experience*

Table 3. *Having an Engineer Relative is Beneficial to an Engineering Graduate's Career (n = 65)*

Response	Frequency	Percentage (%)
Yes	40	61.5
No	25	38.5
Total	65	100

The respondents were asked if they think that having an engineer relative will help them get a job related to their field of engineering easier. Table 3 shows that 61.5% of the respondents answered yes which therefore implies that it is beneficial to have an engineer relative. But because not everyone has the same advantage as those who have an engineer relative, this same reason results in a lack of experience.

On the other hand, the majority of the respondents disagreed that having a “backer” is recommended when planning to pursue any field in engineering, as seen in Figure 2. This implies that an engineering graduate does not necessarily need connections to thrive in the engineering industry.

3.1.1.2. *Reasons that result in limited job opportunities*

The results in Figure 2 show that the respondents agree that government engineering-related departments must allot bigger funds to help struggling engineers. This includes higher paygrade, more job opportunities in the country, and such. Respondents also agree that the need to pass the board exams can be a cause of underemployment as some fail to pass the board examinations. It can also be perceived from Figure 2 that experienced engineers are more likely to get employed rather than fresh engineering graduates. This limits the opportunity of fresh engineering graduates to gain and build experience, which eventually leads to a lack of experience.

3.1.1.3. *Reasons that result in competition*

As shown in Figure 2, the respondents agree that the name of the university affects the employability of engineering college graduates. This gives more advantage to those who graduated from prestigious and excelling engineering universities. The respondents also agree that having high grades and a lot of achievements will increase the employability of an engineer, as well as joining career-related organizations. These results all lead to having many competitions.

3.1.1.4. *Reasons that result in a substandard education system*

According to the results also shown in Figure 2, engineer respondents agree that universities must associate with engineering companies for a better quality of education. However, the respondents disagree in restricting each engineering college program to also have a balanced number of students to also have an equal number of graduates per college program. This indicates that engineering students must already have firsthand experience and knowledge from experienced engineers while they are still in college.

Along the process of the data collection, it has also come to the researchers' attention that only a few universities here in the Philippines have undergraduate engineering programs that are ABET-accredited—and to name one of these few and fortunate universities is the De La Salle University-Manila. According to ABET's website, “*ABET accreditation assures confidence that a collegiate program has met standards essential to prepare graduates to enter critical STEM fields in the global workforce.*” This could be a wake-up call to universities around the Philippines that are not doing the bare minimum to assure that engineering programs here in the country are leveled as those of other foreign countries. Graduating from an ABET-accredited program could make a significant impact on an engineering graduate's career.

3.2. *Top three fields of Engineering that often experience underemployment*

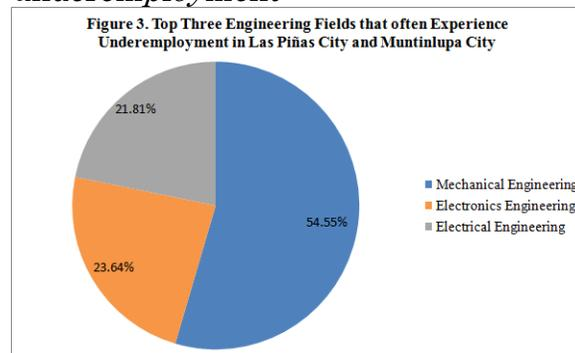

The results have shown, as seen in Figure 3, that the top three engineering fields that often experience underemployment are as follows: Mechanical engineering, Electronics Engineering, and Electrical Engineering. This data is derived from the (1) college degree of the respondents, which is indicated in their profile, and if they have experienced underemployment in that field of engineering, and (2) the respondent's knowledge of which field of engineering mostly experiences



underemployment. The researchers combined both data and constructed a unified interpretation.

4. CONCLUSIONS

Underemployment continuously happens around the world, most especially in the Philippines, regardless of the industry an individual is in. But just like any other discoveries made by many individuals, a once unsolvable problem is now susceptible to a solution.

The main cause of underemployment in Las Piñas City and Muntinlupa City is lack of experience. Followed by limited job opportunities, many competitions, and a substandard education system. The results from the Likert scale that the researchers used are also considered as driving factors of the main causes of underemployment. It has been discovered from the results that the name of the university affects the employability of engineering graduates, even the grades and achievements an engineering graduate attained during their student years. Fresh engineering graduates must also be more proactive since experienced engineers are more likely to be employed in the engineering industry.

The researchers have discovered that the top three engineering fields that often experience underemployment in Las Piñas City, and Muntinlupa City are: Mechanical Engineering, Electronics Engineering, and Electrical Engineering. It is recommended that engineering-related departments and agencies of the government must put more attention to these fields, as well as strategize on possible ways that can help struggling engineers of these fields, like collaborated projects, incentive awards, perks, benefits, and such to also avoid brain drain.

It is thereby concluded that experience is one of the vital weapons an engineer can and must have in the engineering industry. It is suggested that universities and engineering firms and associations must work together to provide basic experience to engineering students. External help from the engineering departments of the government would also be beneficial in lessening underemployment in the country. Universities are also recommended to have ABET-accredited engineering programs. Employers are also recommended to set more realistic job qualifications and expectations for entry-level applicants.

Derived results are also similar to what the researchers have provided as choices in the survey questionnaires. Some respondents might have settled for what was provided rather than share from experience. For further research, a few modifications and improvements can still be made such as more items in the survey questionnaires,

wider research locale, and a bigger number of respondents to also obtain more diverse responses.

5. ACKNOWLEDGMENTS

The researchers thank God and their families for giving their best support and guidance throughout this study. It is a blessing to the researchers that they had the strength and willpower to do and finish this study.

The researchers are also thankful to their alma mater, the University of Perpetual Help System DALTA – Las Piñas Campus, for giving the researchers a strong foundation in conducting this research paper.

They are grateful to the Senior High School Department Faculty members for giving their time and effort in reviewing and analyzing this study. As well as for giving various advice and clear instructions on how to do this research paper right. Lastly, for guiding the researchers throughout the whole process by examining the study and recommending alternative ways for the improvement of this research paper.

The researchers extend their thanks to the following administrators of the Senior High School Department: to Ms. Marielle T. Rubio, the English and Research Area Learning Coordinator, and to Mrs. Mary Grace F. Tomulac, the Senior High School Academic Coordinator

and Assistant Principal for Grade 12, for allowing the researchers to gather the necessary data for this study.

The researchers are also thankful to Dr. Julia H. Reyes, the SHS Principal/OIC, Basic Education Director of the University of Perpetual Help System DALTA – Las Piñas Campus, who gave her full support to the researchers in conducting this research.

The researchers would like to thank, more especially, Mr. Wilfred Glenn Tirol Catud, their Research Instructor and Thesis Adviser, for allowing the researchers to conduct this study, for guiding the researchers every step of the way, and for helping in the completion of this manuscript.

6. REFERENCES

- Abel, J., Deitz, R., & Su, Y. (January 2014). Are Recent College Graduates Finding Good Jobs? Current Issues in Economics and Finance, Vol. 20, No. 1, 2014, Retrieved from <https://ssrn.com/abstract=2378472>
- Abel, J., & Deitz, R. (December 2015, Revised September 2016). Underemployment in the Early Careers of College Graduates Following the Great Recession. Federal Reserve Bank of New York Staff Reports, no. 749. JEL Classification: I23, J23, J24, J62. Retrieved from https://www.newyorkfed.org/medialibrary/media/research/staff_reports/sr749.pdf?la=en



- Abet. (2015). Accreditation. Setting the Standard Worldwide. Baltimore, MD: Abet.org. Retrieved from <https://www.abet.org/accreditation/>
- Alves, A., Kahlen, F.-J., Flumerfelt, S., & Manalang, A.B.S. (2013, Published online April 2014). Comparing Engineering Education Systems Among USA, EU, Philippines and South Africa. Volume 5: Education and Globalization. <https://doi.org/10.1115/imece2013-63254>
- Ambag, R. (August 2018). STEM in The PH Workforce: A Critical, Ever-Growing Need. Flip Science. Retrieved from <https://www.flipscience.ph/news/features-news/features/stem-ph-workforce/>
- Atkinson H., & Pennington M. (December 2015). Unemployment of Engineering Graduates: The Key Engineering Education Issues. pp. 7-15 Retrieved from <https://www.tandfonline.com/doi/full/10.11120/ened.2012.07020007>
- Balba, N. (October 2019). Graduate Tracer Study for Electronics Engineering Program (2016- 2018). LPU-Laguna Journal of Multidisciplinary Research. Vol. 3 No. 3. Retrieved from <https://pulaguna.edu.ph/wp-content/uploads/2019/11/8.-Graduate-Tracer-Study-for-Electronics-Engineering-Program-2016-2018.pdf>
- Bhaskar, S. (August 2019). A Research on Causes of Underemployment of Engineering Graduates through Quality Control (QC) Tool - Affinity Diagram (KJ Method). International Journal of Engineering and Advanced Technology. ISSN: 2249 – 8958. Volume-8 Issue-6S. <https://doi.org/10.35940/ijeat.f1107.0886s19>
- Brooks, R. (February 2002, Posted January 2006). Why is Unemployment High in the Philippines? IMF Working Paper No. 02/23. Retrieved from <https://ssrn.com/abstract=879369>
- Brown, R. (January 2019). New data reveals sunny outlook for engineering graduates' job prospects. Create Digital, Engineers Australia. Retrieved from <https://createdigital.org.au/new-data-outlook-engineering-graduates-job/>
- Chavez, N., Camello, N., Dotong, C., & Pamplona, M. A. (February 2017) Employability of Engineering Graduates from 2013 to 2015 as Basis for a Propose. Asia Pacific Journal of Multidisciplinary Research. Vol. 5 No.1, 155-166. (Part II). P-ISSN 2350-7756 E-ISSN 2350-8442. Retrieved from <http://www.apjmr.com/wp-content/uploads/2017/03/APJMR-2017.5.1.2.16.pdf>
- Chen, J. (November 2020). Underemployment. Investopedia. Economy, Economics. Retrieved from <https://www.investopedia.com/terms/u/underemployment.asp>
- Cooper, P. (June 2018). Underemployment Persists Throughout College Graduates' Careers. Jersey, NJ: Forbes. Retrieved from <https://www.forbes.com/sites/prestoncooper/2018/06/08/underemployment-persists-throughout-college-graduates-careers/?sh=7184142f7490>
- Dotong, C., Chavez, N., Camello, N., De Castro, E., Prenda, M. T., & Laguador, J. (January 2016). Tracer Study of Engineering Graduates of One Higher Education Institution in the Philippines for Academic. Research Gate. Retrieved from https://www.researchgate.net/publication/309041049_T_RACER_STUDY_OF_ENGINEERING_GRADUATES_OF_ONE_HIGHER_EDUCATION_INSTITUTION_IN_THE_PHILIPPINES_FOR_ACADEMIC_YEAR_2009-2012
- Federal Reserve Bank of New York. (2021). The Labor Market for Recent College Graduates. New York, NY: Newyorkfed.org. Retrieved from <https://www.newyorkfed.org/research/college-labor-market/college-labor-marketcompare-majors.html>
- Gibbons, S. (2016). The Lived Experiences of Underemployed First-generation College Graduates. Iowa, IO: University of Iowa. <https://doi.org/10.17077/etd.q40lmx5x>
- Habito, C. (June 2019). Why Do We Lack Engineers? Philippines: Inquirer. Retrieved from <https://opinion.inquirer.net/121900/why-do-we-lack-engineers>
- Hazaymeh, E.N.M., & Dela Pena, M.K. (2019). A Tracer Study of La Salle University College of Engineering Graduates. Retrieved from https://lsu.edu.ph/application/files/1114/7193/8568/Vol._18_No._1_A_Tracer_Study_of_La_Salle_University_College_of_Engineering_Graduates.pdf
- Ingraham, C. (August 2014). The College Majors Most and Least Likely to Lead to Underemployment. Washington, DC: The Washington Post. Retrieved from <https://www.washingtonpost.com/news/wonk/wp/2014/08/26/the-college-majors-most-and-least-likely-to-lead-to-underemployment/>
- Japan International Cooperation Agency Nomura Research Institute, Ltd. (2015). Data Collection Survey for Higher Education Sector in the Philippines: Final Report. Retrieved from <https://openjicareport.jica.go.jp/pdf/12233029.pdf>
- Mapa, C.D. (September 2019). Employment Rate in July 2019 is Estimated at 94.6 Percent. Philippine Statistics Authority. Retrieved from <https://psa.gov.ph/content/employment-rate-july-2019-estimated-946-percent>
- Mellors-Bourne, R. (November 2016). Employment Outcomes of Engineering Graduates: Key Factors and Diversity Characteristics. London, United Kingdom: Royal Academy of Engineering. ISBN: 978-1-909327-30-6. Retrieved from <https://www.raeng.org.uk/publications/reports/employment-outcomes-of-engineering-graduates-key-f>
- Origeneza, G. (September 2013). Underemployment in the Philippines: A Problem Indeed. iBlog Geo. Retrieved from <http://animogeo.blogspot.com/2013/09/underemployment-in-philippines-problem.html>
- Santos, C. (July 2020). Struggles of Being an Engineer in the Philippines. Philippines: GineersNow. Retrieved from <https://gineersnow.com/leadership/struggles-engineer-philippines>
- Torpey, E. (February 2018). Engineers: Employment, pay, and outlook. Washington, DC: Career Outlook, U.S. Bureau of Labor Statistics. Retrieved from <https://www.bls.gov/careeroutlook/2018/article/engineers.htm>
- Trevelyan, J. P., Tilli, S. (Accepted August 2009, Published online November 2015). Labour Force Outcomes for Engineering Graduates in Australia. Australasian Journal of Engineering Education. Volume 16, 2010. Issue 2. pp. 101-122. Retrieved from <https://www.tandfonline.com/doi/abs/10.1080/22054952.2010.11464047>



The Benefits of Taking Math and Science Enrichment to the STEM Strand in Senior High School

Therese Claire Marie A. Jarcia, and Bianca Ma. Sophia R. Untalan
Assumption College, Makati City

Abstract: This study was about the benefits of Junior High School Math and Science (AGHAMON) Enrichment in the Senior High School STEM (Science, Technology, Engineering, and Mathematics) Strand. This was conducted to determine the advantages of Junior High School Enrichment Programs in relation to the student development and behavior in the STEM Strand of Senior High School. The development of students was measured by percentage on personal response to different situations encountered in Senior High School with the guidance of previous courses taken in Junior High School. This was done through the measurement of Google Forms.

This study showed that the effects of Math Enrichment and AGHAMON has no significant benefits on the experience of students taking the STEM Strand in Grades 11 and 12. From the transition from Junior High School to Senior High School, the Math and Science Enrichment programs provided the students with background knowledge in preparation to the concepts discussed in Senior High School, though there was a given difference in the level of difficulty in new topics introduced in the STEM curriculum. However, the students were still able to apply and relate what they had previously learned to the intermediate subjects of the strand and obtain an open mindset to the willingness to learn and collaborate in a new working environment.

Key Words: Science; Mathematics; Curriculum; Learning; Enrichment

1. INTRODUCTION

1.1. Rationale

The Republic Act 10533 and the Enhanced Basic Education Act of 2013 introduced the K-12 Program in the Philippines. The STEM curriculum has been integrated into the Philippine educational system as one of the academic tracks available for students to follow in Senior High School. To meet the specific skills one would need in the desired career, the Department of Education developed a program consisting of science and mathematics-oriented courses. This includes the subjects of Pre-Calculus, Basic Calculus, General Biology 1 and 2, General Physics 1 and 2, and General Chemistry 1 and 2 (Department of Education, n.d.). Furthermore, these subjects practice the adeptness of students in research and analysis.

Assumption College Makati City has implemented the Science (AGHAMON) and Math Enrichment programs to help the students improve their skills both mathematically and scientifically. In the Philippines, this is known as “gifted education”, which allows academically gifted students to develop their needed skills. Though deemed as a privilege given the high cost to implement the program in some schools, providing exemplary students with advanced

education is their right (Pawilen & Manuel, 2018). To make STEM Education more accessible in the country, the government has ensured to place different initiatives in line with the students’ academic needs. First, the government has implemented acceleration programs, enrichment activities, advanced classes, and the like to strengthen STEM knowledge (Pawilen, 2018).

However, the gifted students who are invited to partake in the Math and Science Enrichment Programs in Assumption College are not much knowledgeable on the specific benefits this may contribute to their learning skills and attitudes in Senior High. Therefore, the researchers conducted a research on the advantage of taking Junior High School Science and Math Enrichment Classes in preparation for Senior High.

1.2. Statement of the Problem

This study evaluated the advantage of taking Science and Math Enrichment in Junior High School to their learning experience in taking the STEM strand.

1. To what extent can taking Science and Math Enrichment be an advantage in taking the STEM strand?



2. Do Enrichment Programs have a significant effect on one's learning process in Senior High School?
3. What are the curriculum-based skills that students have developed from taking Junior High Enrichment Programs toward Senior High STEM-related subjects?

1.3. Hypothesis

Taking AGHAMON and Math Enrichment Programs in Junior High School do not have a significant effect on one's learning process in Senior High School.

2. METHODOLOGY

2.1. Research Design

The study held a descriptive research design as it includes the evaluation of the benefits of students in the STEM strand from formerly attending Science and Math Enrichment programs.

2.2. Sample and Sampling

The researchers used the technique of stratified random sampling in selecting the respondents of the study. The researchers were able to proportionally select samples from different groups for the study, attaining a variety in the representation of the population. The respondents selected for this study were the Grade 11 and 12 students of Assumption College Senior High School. This was limited to seventeen (17) students of the STEM strand, following the criteria of formerly attending both AGHAMON and Math Enrichment programs in Junior High.

2.3. Research Instrument

The researchers created their own research tool. This was a survey conducted through Google Forms. This was administered to have a survey regarding how the Math and Science Enrichment programs had helped the students in their learning environment in Senior High School (SHS). This was able to determine the extent of the advantages brought about by the Enrichment classes offered by Assumption College.

The survey was a twenty-four (24) item set questionnaire. In addition, the set made use of the Likert scale and multiple choice questions. It is divided into six main parts, which are as follows:

1. Experiences in Math Enrichment
2. Experiences in Science Enrichment
3. Learning & Adaptive Skills from Math and Science Enrichment
4. Curriculum-based Skills from Math and Science Enrichment

5. The General Benefits gained from the programs
6. The Effectiveness of the Programs to the Learning Environment and Behavior in Senior High School.

All by which pertained to the ability of the researchers to measure the benefits the students were able to gain from participating in the enrichment programs, and to determine the curriculum-based enrichment skills that the students were able to develop from Junior High School (JHS) as they transition towards Senior High STEM-related subjects.

2.4. Data Gathering Procedures

Preparation of the Research Instrument/Adapted Survey Questionnaire

The researchers made their own survey instrument about the benefits and advantages brought about by the JHS Science and Math Enrichment Programs to the learning process, learning environment, and the perceived advantages of retaining curriculum-based skills in SHS. After that, the researchers wrote a consent letter to the selected Grade 11 and 12 students. This was signed and noted by the Research Adviser.

Administration of the test to the respondents

The researchers administered the created survey to seventeen (17) students from both Grade 11 and Grade 12 through an online Google Forms survey. The outcome was gathered by the researchers. The data was interpreted and evaluated, and then the results were analyzed by the researchers.

2.6. Data Analysis

The researchers used the statistical treatment of descriptive statistics for the study. This was used to analyze the perception of students among the Grade 11 and 12 STEM strand based on their experiences from AGHAMON and Math Enrichment classes, adapted skills, and learning environment and behavior. Moreover, the researchers used this to evaluate the benefits of the enriched programs from the JHS setting to the SHS setting.

3. RESULTS AND DISCUSSIONS

Problem 1

To what extent can taking Science and Math Enrichment be an advantage in taking the STEM strand?



Adjustment Period

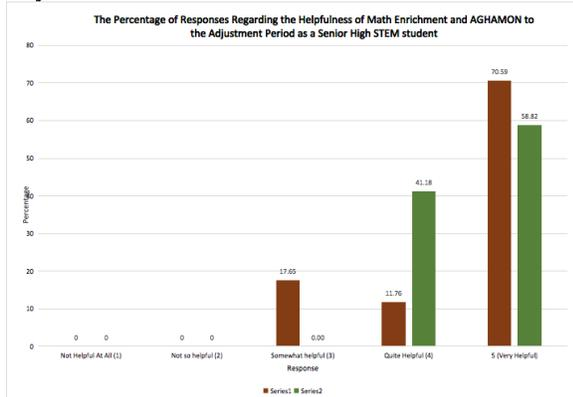

Fig. 1.1 The Percentage of Responses Regarding the Helpfulness of Math Enrichment and AGHAMON to the Adjustment Period as a STEM student

Figure 1.1 showed the usefulness of both Math and AGHAMON to the students' adjustment period for Senior High School based on their answers on Question 4 and 8 of the survey. With this, one can infer that Math Enrichment and AGHAMON greatly benefitted the students in their transition periods, posing as a great advantage in taking the STEM strand.

	QUESTION 4	QUESTION 8
Mean	3.4	3.4
Variance	24.8	22.8
Observations	5	5
Hypothesized Mean Dif	0	
df	8	
t Stat	0	
P(T<=t) one-tail	0.5	
t Critical one-tail	1.859548038	
P(T<=t) two-tail	1	
t Critical two-tail	2.306004135	

Fig. 1.2 Question 4 and 8 under Research Question 1 presented through a Likert Scale regarding the Level of Helpfulness from 1 (Not helpful at all) to 5 (Very Helpful)

The researchers made use of the mean to compare two separate variables: Math Enrichment and Science Enrichment to one specific factor, which is the advantage towards the transition period in Senior High. The researchers wanted to see if there is a difference in the usefulness of Math and Science Enrichment to the transition period in SHS. Furthermore, the data above show that the mean of number 4 and number 8 are equal, with the value of 3.4. With the mean values showing no difference, the researchers can conclude that the enrichment programs are equally useful to the transition to SHS.

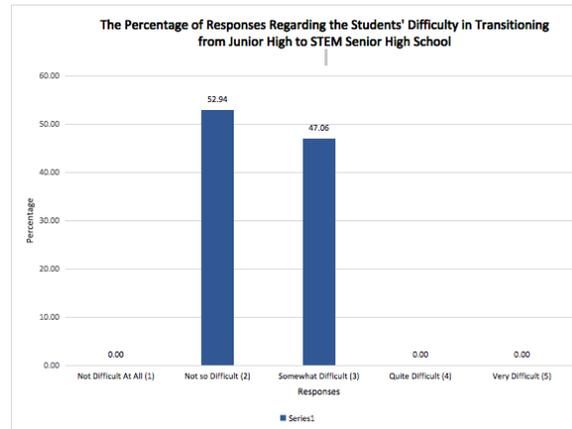

Fig. 2.1 Students' Difficulty in Transitioning from Junior High School to STEM Senior High School

Figure 2.1 shows the percentage of difficulty in transitioning from Junior High school to STEM in Senior High school. Given choice 2 and choice 3, it can be said that students have experienced some manageable difficulties in their transition as STEM students in Senior High school.

Problem 2

Do Enrichment Programs have a significant effect on one's learning process in Senior High School?

Learning Process

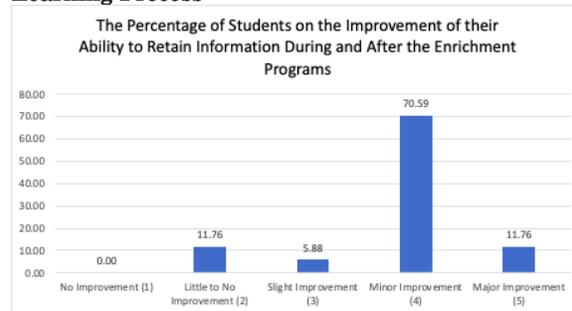

Fig. 3.1 The Percentage of Students on the Improvement of their Ability to Retain Information During and After the Enrichment Programs

Figure 3.1 presents the number of students on the improvement of their abilities in retaining information during and after Math Enrichment and AGHAMON by their respective percentages. From this, it can be seen that the majority of the students had developed skills in their way of thinking throughout their JHS experiences in Math Enrichment and AGHAMON, and were able to further develop their methods on retaining information beyond the circumstances.

Fig. 3.2 The Percentage of Students on the Usefulness of their Ability for Self-learning and Collaboration from JHS to SHS

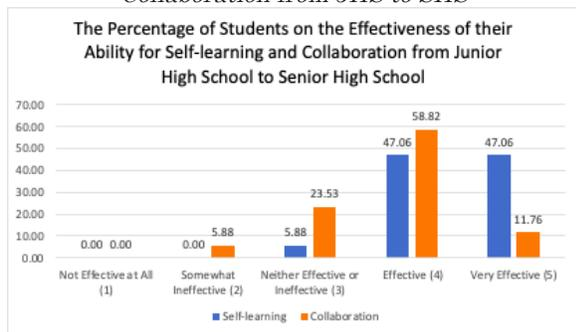

Figure 3.2 is a summary of the percentages of students on the usefulness of Junior High School Enrichment programs on their abilities among self-learning and collaboration in the experience of Senior High School.

Perceived Advantages

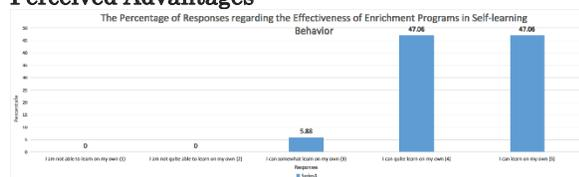

Fig. 3.3 Effectiveness of Enrichment Programs in Self-Learning Behavior

Figure 3.3 shows the percentage regarding the effectiveness of the enrichment programs in self-learning behavior. Given that the two responses fall under the positive response towards self-learning, the researchers concluded that the enrichment programs have greatly benefitted the students in terms of their ability to learn on their own.

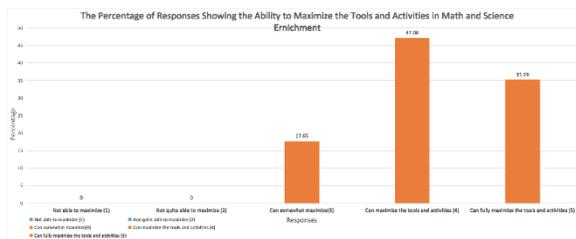

Fig. 3.4 Ability to Maximize Tools in Enrichment Programs

Figure 3.4 pertains to Question 12 in the survey which talks about the ability of the students to maximize the tools and activities in the enrichment programs. From the graph, it can be said that the students are generally able to maximize the tools and activities of the said programs.

Problem 3

What are the curriculum-based skills that students have developed from taking Junior High Enrichment Programs toward Senior High STEM-related subjects?

Curriculum-based Skills in Math-related Subjects

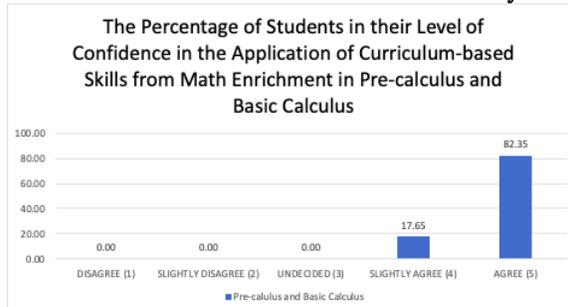

Fig. 4.1 The Percentage of Students in their Level of Confidence in the Application of Curriculum-based Skills from Math Enrichment in Pre-calculus and Basic Calculus

Figure 4.1 presents the percentage of the level of confidence STEM students have in their personal application of curriculum-based skills from Math Enrichment in the specified courses for specialized subjects under the DepEd syllabus. Majority of the students agreed to the statement of having the ability to apply simple advanced mathematical skills and concepts learned from Junior High Math Enrichment in Senior High subjects.

Curriculum-based Skills in Science-related Subjects

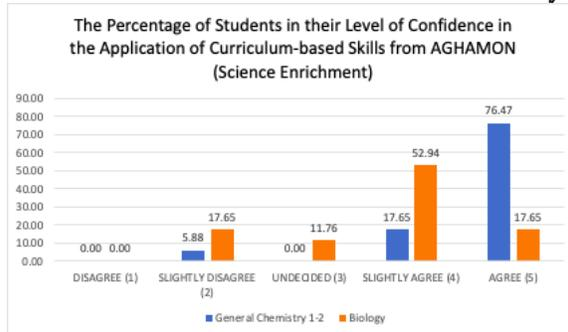

Fig. 4.2 The Percentage of Students in their Level of Confidence in the Application of Curriculum-based Skills from AGHAMON (Science Enrichment)

Figure 4.2 summarizes the number of Grade 11 and 12 STEM students in their level of confidence in applying Science-related curriculum-based skills developed from AGHAMON in the specialized courses of the STEM strand. The majority of the Grade 11 and 12 students agree to their ability to apply previous lessons from AGHAMON to their specified classes for SHS, while others may find difficulty in doing so.



4. SUMMARY AND CONCLUSIONS

4.1. Summary of Findings

1. There is no significant difference between taking Math Enrichment and Science Enrichment in terms of gaining an advantage in taking up the STEM strand.
2. The results regarding the benefit of Math Enrichment and AGHAMON to the SHS adjustment period yield a percentage of 70.59% for Math Enrichment and 58.82% of Science Enrichment, thus considering their respective programs to be an advantage in their transition to STEM.
3. Grade 11 and 12 students were effectively able to develop their skills and mindset in retaining new information during and after Junior High Enrichment Programs.
4. A tie was seen between the respondents' answer. 47.06% of the respondents said that they can quite effectively learn on their own, whereas 47.06% of the other respondents said that they can effectively learn on their own.
5. Among the respondents, 82.35% fully agree to having the ability to relate and apply previous concepts introduced in the Math Enrichment program to the Pre-Calculus and Basic Calculus subjects.
6. Majority of the students were well-equipped with skills and background knowledge retained from previous experiences in the AGHAMON program and were able to implement these in Chemistry 1 and 2, and Biology.

4.2. Conclusions

1. Math and Science Enrichment allowed the students to gain a positive perspective on being able to retain information, collaborate with others, and learn the lessons in Senior High on their own.
2. There is no significant difference between the independent effects of Math and Science Enrichment in being an advantage when taking the STEM strand in Senior High. The topics taken in these subjects could help as a primer towards the students' future lessons in the academic strand. However, there are given differences towards the topics discussed in the academic curriculum between the two subjects in Junior High and Senior High, and in the level of difficulty between the Math and Science Enrichment programs and the Senior High STEM curriculum.

3. The Grade 11 and 12 students efficiently developed background knowledge on Science and Math related concepts from AGHAMON and Math Enrichment. In the Senior High School setting, the students were able to integrate what they had previously learned to new lessons introduced in the STEM strand.

4.3. Recommendations

1. Considering that the survey only focused mainly on the learning skills learned from the Enrichment Programs in Junior High, the future researchers are encouraged to identify the academic benefits by comparing the curriculum in Math Enrichment and AGHAMON to the STEM strand.
2. With only 17 respondents included in the sample of the study, the future researchers are encouraged to broaden the number of students and the criteria used to select respondents. For the basis used for the qualifications of research participants, it is encouraged to include students who did not attend the Science and Math Enrichment programs in order to further identify the benefits of the specified programs, differentiate the learning behavior and curriculum based skills applied in the STEM strand.
3. This research only included two out of the four Enrichment programs provided in Assumption College Junior High School. The future researchers are encouraged to study the English/Grammar and Filipino Enrichment programs and identify its benefits to the core and contextualized subjects included in the STEM curriculum.

5. ACKNOWLEDGMENTS

We would like to extend our deepest gratitude to the Almighty God for the blessing of strength and courage to continue pursuing our endeavors.

To our families, who gave us motivational support and complete understanding as we finish our final paper.

To our Research in Daily Life II adviser, Ms. Rose Marie C. Legaria, and to our CAPSTONE adviser, Ms. Mariz Ortiz, we extend our gratitude to you for guiding us throughout writing the whole research paper. We thank you for sharing your expertise, time, and effort to direct us in making a research paper worth noting. Without your help, we know we cannot make it.

To Assumption College, Makati City, who allowed us to reach out to other students who took the Math and Science Enrichment Programs in Junior



High School to answer our survey and participate in our study.

Lastly, to our classmates, friends and all the other people who were always there to encourage and help us in all possible ways, we would like to extend our utmost thank you.

6. REFERENCES

- Arnilla, A. K. A., & Banga, A. (2018). Possibilities and Challenges for STEM Methodology in the Public Senior High Schools in the Philippines. Retrieved from <https://doi.org/10.13140/RG.2.2.20359.04003>
- Bell, S. (2010). Project-based learning for the 21st century: skills for the future. *Clearing House*, (83), 39-43. doi: 10.1080/00098650903505415
- Caprara, G. V., Vecchione, M., Alessandri, G., Gerbino, M., & Barbaranelli, C. (2011). The contribution of personality traits and self-efficacy beliefs to academic achievement: A longitudinal study. *British Journal of Educational Psychology*, 81(1), 78-96.
- Capraro, R.M., Morgan, J. & Corlu, M.S. (2013). STEM Project-Based Learning: an integrated Science, Technology, Engineering, and Mathematics (STEM) approach. *STEM Project-Based Learning*, pp. 109-118.
- Drummond, K., & Murphey-Reyes, A. (2017). Quantitative research designs: Experimental, quasi-experimental, and descriptive. *Jones & Bartlett Learning*, 155-183. https://samples.jbpub.com/9781284101539/9781284101539_CH06_Drummond.pdf
- Goertzen, M. J. (2017). Applying quantitative methods to research and data. *Library Technology Reports*, 53(4), 12-18. <https://journals.ala.org/index.php/ltr/article/view/6325>
- Jarcia, T.C.M.A. (2019). Project-based learning [PDF File]. Retrieved from https://docs.google.com/document/d/1FbTdHM2b_Vew9wPT_4FmBNRG1OWN_gnNEiv2gAMY-7I/edit
- Lazara Jr, Z. J., & Morales, M. P. (2018). Exploring Teachers' Beliefs and Science Curricular Alignment: Cases of Senior High School Philippine STEM Teachers. *Journal of Educational and Human Resource Development*, 6, 120-132.
- Luo, S.M. (2013). The effects of advanced placement and international baccalaureate programs on student achievement (Doctoral dissertation). Retrieved from <https://core.ac.uk/download/pdf/48503919.pdf>
- Miller, E.C., Krajcik, J.S. (2019). Promoting deep learning through project-based learning: a design problem. *Disciplinary and Interdisciplinary Science Education Research*, 1, n.p. DOI: doi.org/10.1186/s43031-019-0009-6
- Oxford Business Group. (n.d.). Initiatives to boost the Philippines' education programmes in science, technology, engineering and mathematics. Retrieved from <https://oxfordbusinessgroup.com/analysis/seeds-stem-initiatives-multiple-levels-look-strengthen-tuition-and-outcomes-science-technology>
- Pawilen, G.T., and Manuel, S. J. (2018). A Proposed Model and Framework for Developing a Curriculum for the Gifted in the Philippines. *International Journal of Curriculum and Instruction*, Vol. 10(2), pp. 118-141. Retrieved from: <http://ijci.wcci-international.org/index.php/IJCI/article/view/165/76>
- Pawilen, G. T. (2018). STEAM Education for the Gifted in Rural Settings in the Philippines. *Annual Meeting of the Japan Society for Science Education*, Vol. 42, pp. 71-74. DOI: https://doi.org/10.14935/jssep.42.0_71
- Rafanan, R. J., & De Guzman, C. Y. (2020). Pursuing STEM Careers: Perspectives of Senior High School Students. *Participatory Educational Research*, 7(3), 38-58. Senate of the Philippines. (2011). K-12: the key to quality education? [PDF Document]. Retrieved from <http://legacy.senate.gov.ph/publications/PB%202011-02%20-%20K%20to%2012%20The%20Key%20to%20Quality.pdf>
- Shogren, K.A., Wehmayer, M.L., & Singh, N.N. (2017). Adaptive Behavior. In Tassé, M.J. *Handbook of positive psychology in intellectual and developmental disabilities: Translating research into Practice*. Retrieved from https://www.researchgate.net/publication/314281841_Adaptive_Behavior
- The Manila Times. (2019, August 29). STEM track prepares HS students for work. Retrieved from <https://www.manilatimes.net/2019/08/29/campus-press/stem-track-prepares-hs-students-for-work/607355/>
- Zhang, D., Cui, Y., Zhou, Y., Cai, M., & Liu, H. (2018). The role of school adaptation and self-concept in influencing Chinese high school students' growth in Math achievement. *Frontiers in Psychology*, (9), 2356. DOI: 10.3389/fpsyg.2018.02356



Exploring the Viability of Augmented Reality as a Supplementary Material for Learning Cell Biology and Photosynthesis for Grade 12 Students

Andrei Migel R. Alviar, Alfonso Jose V. Fernandez, John Ronn P. Parcia,
John Kieffer L. Recato Dy, and Justin Dale B. Villarba
De La Salle University, Manila

Christian Terrence B. Esguerra and Ethel C. Ong
De La Salle University, Manila

Abstract: Augmented reality (AR) is one of the many emerging digital technologies that specializes in gaming, medicine, entertainment, and education. AR-assisted technologies have undergone studies and were claimed to provide a better learning experience for students and lecturers who integrate its features in modern-day classrooms. An example is Google Expeditions, a cost-effective and accessible alternative; however, further research may be needed on such applications, especially when used solely as a supplement. This study assesses AR's effects on Grade 12 students' academic performance and motivation when used as a supplemental learning material for cell biology and photosynthesis. Assessment scores between those who used augmented reality and those who did not reveal a greater improvement in academic performance of the former group. Furthermore, students reported through the Instructional Materials Motivation Survey (IMMS) that they were motivated by the AR tours used during the experiment. These findings point to the potential benefit of integrating AR-based supplementary materials to promote student learning and motivation.

Key Words: augmented reality; academic performance; motivation; cell biology; photosynthesis

1. INTRODUCTION

Digital technology, which refers to all types of electronic devices, equipment, and applications, has been integrated into various schools as educational technologies to facilitate learning and education. These include educational software, learning platforms, and more recently, augmented reality (AR) and virtual reality (Lo & Miller, 2020).

AR-assisted technologies not only give students a new perspective on learning but teachers as well. They provide a platform for experiential learning where students are partially immersed in a physical environment layered with digital elements, allowing them to view objects and models for better visualization and interactive experiences (Shapovalov et al., 2018). A meta-analysis conducted by Radu (2014) attributed AR to increased content understanding, long-term memory retention, improved physical task performance, improved collaboration, and increased student motivation.

One example of AR technologies is Google Expeditions, a platform that aims to bring both AR and VR to educational institutions. It contains a freely accessible catalog of "tours" that discuss a wide range of topics from various subjects. Though head-mounted

devices are required for VR tours, AR tours simply require a smartphone with a camera.

Although numerous studies have reported the benefit of using AR in students' learning, the majority of these experiments utilize dedicated equipment and feature the full-time use of AR. Limited studies regarding more cost-effective and accessible applications such as Google Expeditions are found in literature. In this paper, we describe our experiment in assessing the impact of Google Expeditions on students' academic performance and motivation when used as supplementary material in learning about *cell biology* and *photosynthesis* in Grade 12 General Biology 1 class. We compare the assessment scores of students who used augmented reality as a supplement with those who solely relied on traditional learning methods. We also quantify learner motivation and share feedback from students on their perception of the use of AR technology to motivate them in their study.

2. RELATED WORK

Google Expeditions is a free immersive education app that features various AR and VR environments known as "tours." The app contains



1000 VR tours and 100 AR tours (Google, n.d.), allowing teachers and students alike to use their mobile devices to bring three-dimensional (3D) objects into life by virtually exploring different worlds through the different VR/AR tours.

Cell biology is the study of cells' structure and functions, focusing on both a cell's general properties and a specialized cell's unique features (Pentimalli & Giordano, 2017). It is one of the topics covered in the *General Biology 1* course mandated by the Department of Education. Four related AR tours were identified as relevant by University biology professors, namely tours about plant cells, the type of cells, cell organelles, and photosynthesis. Google Expeditions presents these as static 3D cross-sectional or complete models of particular cell types, organelles, or components. The *Photosynthesis* tour presents similar models of agents involved, including molecular models of some substances.

3. METHODOLOGY

This study adopted a quantitative approach to measure academic performance and a mixed qualitative-quantitative approach to elicit learner's motivation.

3.1. Participants

Fifty-five participants from two sections of Grade 12 Science, Technology, Engineering, and Mathematics (STEM) students to comprise the experimental and the control groups, respectively, gave their consent to participate in the study. Both sections have the same professor who was assigned to teach their General Biology 1 class. The experimental or AR group consisted of 33 students, while the control or non-AR group consisted of 22 students.

3.2. Procedure

Prior to the experiment proper, a *Learner Profile Questionnaire* was given to all participants to gather demographic information such as age, gender, and general average. A pre-test was then administered to both groups in order to assess their existing knowledge about cells and photosynthesis. It consisted of 15 multiple choice questions about cell types, cell structure, cell organelles, and photosynthesis sourced from various existing resources. Both the pre-test and post-test questionnaires were validated by biology professors of the university.

For both the AR and non-AR groups, the class professor conducted synchronous lectures and delivered the same content using the same visual aids. After 3 weeks, both groups were given a supplementary refresher class—in contrast with earlier lectures, the AR group was taught with a live

screencast of Google Expeditions instead of traditional lecture materials. A post-test was answered by the two groups after two (2) days. As recommended by a University biology coordinator, paraphrased versions of the 15 items of the pre-test comprised the post-test.

For the AR group, a revised version of the *Instructional Materials Motivation Survey* (IMMS) by Keller (2010) was given prior to the post-test. The survey is composed of thirty-six 5 point Likert-scale items created by the author with reference to his ARCS model for learner motivation; the model and survey comprises four subscales: *attention*, *relevance*, *confidence*, and *satisfaction*. These were used to quantify participant motivation during the use of the AR application. To support the numerical data, six (6) open-ended questions were added at the end of the questionnaire to solicit qualitative feedback.

3.3. Data Analysis

To determine academic performance, results from the pre-test and post-test questionnaires were compared by calculating the percent changes of the mean scores. A higher positive percent change indicates a greater improvement between pre-test and post-test scores. The number of individual participants who garnered positive, negative, and no changes to their test scores was also displayed using a cluster analysis table. To further assess the statistical significance of one group's improvement compared to the other, an independent samples *t*-test between their respective score changes was conducted through the statistical software Jamovi. Assumptions such as normality and homogeneity of variances were tested to determine the type of *t*-test used.

Data from the IMMS, on the other hand, were analyzed by computing the mean score and standard deviation for each ARCS subscale and its items; a value closer to 5 corresponds to a higher level of motivation. The descriptive statistics of each subscale and their highest-scoring and lowest-scoring items are presented. Responses from the open-ended questions were also associated with the appropriate subscale and used to support the yielded results.

4. RESULTS AND DISCUSSION

Out of 33 participants, 19 from the AR group were able to attend the supplementary refresher class. Along with 20 out of 22 participants from the non-AR group, they were able to complete all data collection instruments. In this section, we present our findings and corresponding analyses of the data gathered from the pre-test, post-test, and IMMS.

4.1. Academic Performance

Comparison of the scores of the AR group and non-AR group is presented in Table 1. The percent



change represents the improvement of students' scores after the lesson was taught to the students. Based on Table 1, the average score that the AR group improved by 22.11% while the non-AR group gained only a 5.84% elevation in score. A cluster analysis of the positive, negative, and neutral changes of each students' scores is also presented in the table.

The AR group had the most number of positive changes in scores (13 students or 68%) while the non-AR group had 10 students (50%). In terms of negative change, the AR group only had three students (16%), while the non-AR group had nine (45%). Only three students (16%) from the AR group and one student (5%) from the non-AR group had no change in scores.

Table 1. Comparison of academic performance per group

Group	Average			Frequency		
	Pre-test Score	Post-test Score	% Change	Negative Change	No Change	Positive Change
AR (n= 19)	9.63	11.11	22.11%	3	3	13
No AR (n= 20)	10.85	11.10	5.84%	9	1	10

Table 2 presents the results of the independent samples *t*-test for the mean score change (i.e., post-test score minus pre-test score) between both groups. Data were successfully tested for normality and homogeneity of variances. According to Student's *t*-test, $t(37.0) = 1.92, p < 0.05$ (one-tailed), the AR group had a statistically significant greater score change compared to the non-AR group. On average, the AR group's post-test score was 1.47 greater than their pre-test score, while the non-AR group's score only increased by 0.25.

Table 2. Independent samples *t*-test

Score Change	Statistic	df	p
Student's <i>t</i>	1.92	37.0	0.031

Note: H_a AR > No AR

4.2. Motivation

Descriptive statistics for each motivation subscale of the IMMS are presented in Table 3. All four motivation subscales yielded a mean above 3.5, indicating that, on average, the AR group found it *moderately true* that the Google Expeditions induced motivation. Descriptive statistics for the highest-rated and lowest-rated items per subscale are presented in the table.

Among all the motivation subscales, the *attention* criterion obtained the highest mean ($M = 3.88$) and least-dispersed data ($SD = 0.53$). This

implies that Google Expeditions did best in capturing the interest and prompting the curiosity of the participants. As seen in Table 2, the highest-scoring item ($M = 4.45, SD = 0.59$) referred to *attention* as well. Several participants affirmed this with comments such as, "It was cool and refreshing because it's new," and "I was amazed when our teacher showed us the cell through a camera."

Relevance obtained the lowest overall mean, indicating that Google Expeditions was least compatible or connected to the learners' goals. For instance, some participants commented that the application was "unnecessary as all the information and content may have been presented in a textbook" and "no different to other reading materials that had pictures."

Table 3. Descriptive statistics for IMMS subscales and their highest-rated and lowest-rated items

IMMS Subscale	M	SD
Attention	3.88	0.53
15. The AR application is interesting and appealing.	4.45	0.59
28. The variety of the lessons in the AR application helped keep my attention on the lessons.	3.27	1.11
Relevance	3.60	0.71
6. It is clear to me how the content in the AR application is related to things I already know.	4.05	1.00
16. The content in the AR application is relevant to my interests.	3.18	0.98
Confidence	3.63	0.50
34. I could understand quite a bit of the material in the AR application.	4.18	0.72
25. After using the AR application for a while, I was confident that I would be able to pass a test on the material.	3.09	1.14
Satisfaction	3.64	0.90
36. It was a pleasure to use such a well-designed AR application.	3.95	1.00
5. Completing the exercises in the lessons after using the AR application gave me a satisfying feeling of accomplishment.	3.27	1.16

Nonetheless, the application was shown to have increased the participants' *confidence* or expectations of successfully understanding the lesson, as seen in item no. 34 ($M = 4.18, SD = 0.72$). Participants have noted that AR could "make the learning of students easier" and that the visualizations make the biology lesson "comprehensible."

In terms of *satisfaction*, participants moderately agree that Google Expeditions was well-designed ($M = 3.95, SD = 1.00$). The said criterion



received the most-dispersed results ($M = 3.64$, $SD = 0.90$). Related comments from the participants vary positively and negatively, from “*It has everything I need*” to “*Using Google Expeditions currently sucks. If we give it more time to develop into a more robust application, then it could be worthwhile to use the tech.*”

5. CONCLUSION AND RECOMMENDATIONS

Based on the findings presented, this study shows that AR as a supplementary tool has a positive effect on student academic performance and motivation. The group who used AR achieved greater improvement in their test score, reflecting better academic performance. Meanwhile, the resulting statistics on the motivation subscales which include attention, relevance, confidence, and satisfaction indicate that AR induced the learning motivation of those who have used it. With these promising results along with other existing studies, it can be established that implementation of AR as a supplementary material is certainly viable and has a big potential in revolutionizing the learning experience of students.

Findings reported in this study can serve as a foundation for future research needed in the development of more effective strategies and learning methods that will optimize AR in the educational field. The use of other AR applications can be explored to determine the best fit for various purposes, and the research sample size can be expanded to cover more diverse study groups. The length of time using the AR application can also be extended to capture more conclusive results, and instead of merely finding out whether the AR group was motivated, the motivation of both groups can also be compared.

Despite many pointing out AR’s advantages, its application in the educational arena is still at its infancy stage. There remains a lot more to discover and learn about next-generation AR technologies and how they will transform the future of learning.

6. REFERENCES

- Google. (n.d.). *What is Expeditions?*
<https://support.google.com/edu/expeditions/answer/6335093?hl=en>
- Keller, J. M. (2010). *Motivational design for learning and performance: The ARCS model approach*. Springer Science & Business Media.
<http://books.google.com/books?vid=1441912509>
- Lo, S. L., & Miller, A. L. (2020). Learning behaviors and school engagement: opportunities and challenges with technology in the classroom. *Technology and Adolescent Health*, 79-113. <https://doi.org/10.1016/B978-0-12-817319-0.00004-9>
- Pentimalli, F., & Giordano, A. (2017). Cell biology and genetics. *Reference Module in Life Sciences*.
<https://doi.org/10.1016/B978-0-12-809633-8.12390-8>

- Radu, I. (2014). Augmented reality in education: a meta-review and cross-media analysis. *Personal and Ubiquitous Computing*, 18(6), 1533-1543.
<https://doi.org/10.1007/s00779-013-0747-y>
- Shapovalov, Y., Bilyk, Z., Atamas, A., Shapovalov, V., & Uchitel, A. (2018). The potential of using Google Expeditions and Google Lens tools under STEM-education in Ukraine. *Educational Dimension*, 51, 90-101.
<https://www.journal.kdpu.edu.ua/ped/article/download/3659/3337>



Feasibility of Using Phone and Web Cameras to Detect Micro-Expressions for Lie Detection

Lanz Kendall Lim, Eden Paige Ong, Carl Arjan Ramos,
Mico Dellosa, and Fritz Kevin Flores
St. Edward School, General Trias City, Cavite

Abstract: This study explores the feasibility of using low-resolution cameras as a means of detecting facial movements for lie detection. Micro-expressions, however, are difficult to detect by the human eye due to their short duration and low intensity, thus the research explores the possibility of extracting micro-expressions from phone or web cameras that have low resolution and framerate. The collected videos are the processed using time series processing, to obtain both facial data points extracted from facial landmark detection models, as well as image generation from the obtained datapoints to produce a face structure. The classification mainly focuses on the use of common machine learning algorithms, to detect facial movement patterns, in the hopes of classifying people telling truths or lies. The tests ultimately proved to have a low accuracy in classification, but the results show that the methodology may contribute to other domains, such as in person identification, as well as possible recommendations for future works.

Key Words: Facial Landmarks, Image Transform, Machine Learning, Time Series.

1. INTRODUCTION

People have the innate ability to make facial expressions. Feelings of joy, sadness, anger, fear, etc., are expressed on faces via what is commonly interpreted as macro-expressions; however, there are also unseen movements in the face, known as micro-expressions. According to Ekman and Friesen (1969), micro-expressions are involuntary emotional responses that can be used to reveal one's true emotions and claimed that micro-expressions might be the most promising approach to detecting lies; however, micro-expressions are imperceptible to the untrained eye due to their short duration, with an upper limit of 0.5s, and low intensity. Zhang et al. (2014) described that micro-expressions are linked to the flow of expressions and occur unconsciously when emotions are concealed or repressed, expressing certain movement patterns which may aid in identifying individuals telling the truth or lies. Experts would classify micro-expressions according to the emotion being manifested, which is both tedious and time consuming.

Face detection programs have since then been investigated as a means of perceiving micro-expressions. Researchers use high-resolution cameras with framerates of 120 fps or above, to see subtle movements; however, these cameras tend to be expensive and are not always accessible. The study aims to investigate the feasibility of using low-resolution and low-framerate cameras as a means of capturing micro-expressions and facial patterns to classifying truth or lies.

2. Methodology

The methodology is comprised of the Preparation and Data Collection, Facial Landmark Detection and Preprocessing, and Image Generation and Time Series Processing phases.

2.1. Preparation and Data Collection

During this phase, participants undergo an Emotional Intelligence (also known as EQ) Test, to determine if the participant is capable of understanding and managing ones emotions, which may relate to a degree of emotional expressiveness and is used to determine eligibility for participation. This allows selected participants who are generally able to better express emotions, to participate in the study, in the hopes of being able to obtain more descriptive data for processing.

The fifteen selected participants are then oriented regarding the study and requested their consent for participation. They then proceeded to a recorded online interview, comprised of twenty (20) yes-or-no questions, of which they have the option to tell the truth or lie. At the end of the video, the participants are requested to label their answers, to serve as the ground truth.

Each video recording of the online interviews uses 60 fps and is processed by splitting the video per question, and further trimming each one by only retaining the segments where the participants answered. These video segments, containing the participants providing yes-or-no answers, are then

labelled indicating if they are truth or lie, then are sent to the next phase.

2.1. Facial Landmark Detection and Preprocessing

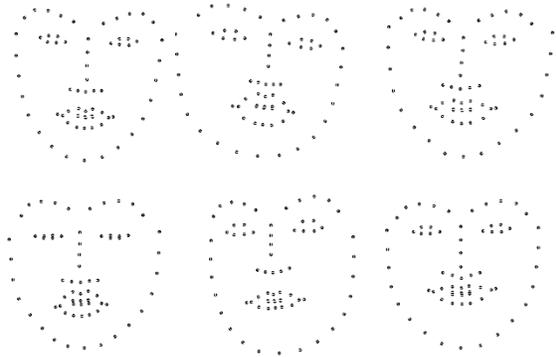

Figure 1. Samples of Facial Landmark Annotation from Video Segment Frames

The labelled video segments are run through a feature extraction algorithm using computer vision and image processing. The process begins by splicing the video segments into individual frames, allowing each frame to be subjected to the facial landmark extraction algorithm. The algorithm enables detection and extraction of sixty-eight (68) facial landmarks from each frame in as presented in Figure 1. This also determines the location of the whole face in the entire frame.

Since different participants are positioned differently in the frame and do not have a constant position across different video segments, even within the same interview, additional preprocessing was implemented. For each video segment, the size of the face relative to the chin and eyebrows, as well as the position of the face relative to the nose, were used as guidelines to perform affine transformation methods of scaling and translation respectively, and in addition, the images were also scaled to an arbitrary 1000px by 1000px image size. This is to normalize the size and position of the faces, across each video segment, for use of processing in the study.

2.2 Image Generation and Time Series Processing

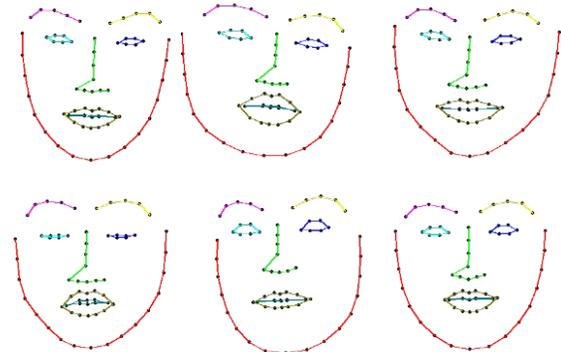

Figure 2. Samples of Facial Landmark Annotation with Facial Feature Annotation

The transformed facial landmark points from the video segments are then processed further to generate two datasets: the image dataset and time series dataset. The image dataset begins by annotating the facial landmark points by using colored lines to connect certain facial features, as seen in Figure 2. The colors and lines are assumed to be useful in processing, by guiding the machine learning algorithms of the different facial features, identified by a unique color scheme.

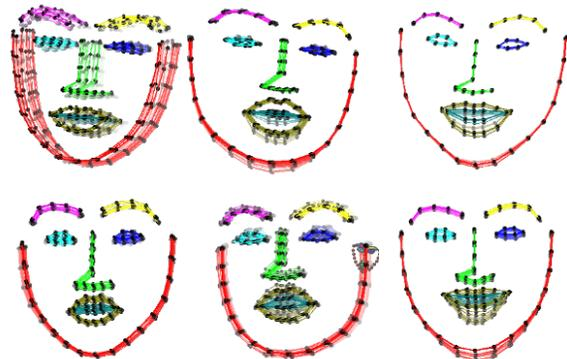

Figure 3. Samples of Facial Movement Annotation with Alpha Adjustment with Respect to Time

Since each video segment is a series of frames, an additional temporal aspect needs to be included, expressing information from the start frame to the end frame of each video segment. Therefore, the solution was to annotate all frames, but have a gradual increase of transparency from 0% to 100%, to represent a gradual transition from transparent to opaque, representing time.

Table 1. Subset from the Initial Facial Landmark Dataset from Feature Extraction

label	participantID	testNum	frameNum	jaw0-x	jaw0-y	jaw1-x	jaw1-y	jaw2-x	jaw2-y
L	0	1	1	714	452	715	503	721	552
L	0	1	2	742	427	742	475	747	521
L	0	1	3	773	439	773	487	776	532

The time series dataset on the other hand, was processed from the initial facial landmark points, containing both x-axis and y-axis for each of the 68 points, with a total of 136 features. Unfortunately, each video segment contains varying number of frames (rows), due to the participants having various durations in providing answers, thus requiring time series processing, to represent the entire sample in only a single row. The algorithm implemented to address the concern was to implement a MinMaxAve Scaling for time intervals with overlap.

The time interval used in the study was to split the video segment into three (3) equal parts, indicating the start, middle, and end of an answer, by dividing the number of frames into three (3) groups. An overlap between the start-middle and middle-end were also obtained using the same number of frames used on the split, creating a total of five (5) subsegments. Each subsegment contained the 136 features from the facial landmark points, and is further processed to get the minimum, maximum, and average of each subsegment, reaching a total of 2040 feature columns per sample. The entire dataset is then normalized using MinMax Scaler for machine learning.

3. TEST RESULTS AND DISCUSSIONS

The time series dataset was investigated using Support Vector Classifier and Linear Regression algorithms to determine its ability to classify the data between truth or lie.

Table 2. Support Vector Classifier Result

Label	Precision	Recall	F1-Score	Support
0 – Lie	50%	25%	33%	12
1 – True	62%	83%	71%	18
Accuracy			60%	30

Using different Train-Test proportions, the best result was obtained using a proportion of 90% train and 10% test. Hyperparameter tuning includes a grid search of the following values: C of 0.01, 0.1, 1, or 10; gamma of 0.1, 0.01, or 0.001; and kernel of rbf, poly, sigmoid, or linear; having the best hyperparameters with C=10, gamma=0.1, and kernel=linear. Unfortunately, with all tests implemented, the accuracy ranged from 47% to 60%, with the highest shown in Table 2 for Support Vector Classifier. Logistic Regression results ranges from 49% to 56%. This means that the classifiers have

difficulty in determining the difference of true and lie from the dataset.

Another investigation was done by performing algorithms in dimensionality reduction via Principal Component Analysis to simplify the dataset features. Additionally, K-Means clustering was performed in order to determine if the clusters are able to distinguish some differences.

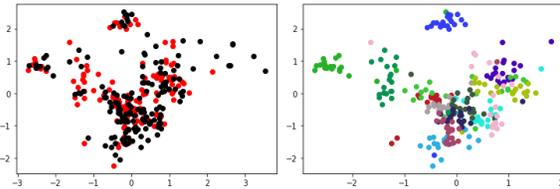

Figure 4. PCA Visualization for Truth and Lies (left) and by Participant (right)

Figure 4 present the results obtained from the PCA Visualization. The left figure uses Red points to denote lie samples and Black points for truth samples. It can be seen that there is not much differences with the truth and lie samples, hence the low accuracy obtained by the Support Vector Classifier and Logistic Regression algorithms. However, even though the images were already normalized through transformations in translation and scaling, figure on the right of Figure 4, presenting a unique point color per participant, still indicated visually observable grouping and clusters for each individual, indicating a similarity in the individuals data despite normalization.

This indicates the possibility that the methodology implemented in the study can, in a way, have the capability for other implementations, such as to identify a participant or individual from the rest, only through the use of the facial landmarks and facial movement of the individual.

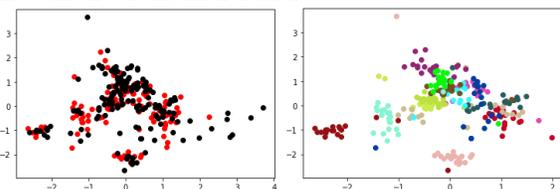

Figure 5. PCA with StandardScaler Visualization for Truth and Lies (left) and by Participant (right)

Additional testing of the hypothesis that the methodology can be used for studies in identification was implemented by implementing PCA one again, but this time, processing the data using Standard Scaling. The result in Figure 5, reveals a result that is somewhat similar to that of Figure 4, where the left image has some difficulty in identifying truth from lie samples, but the image on the right, still shows some form of clustering per participant.

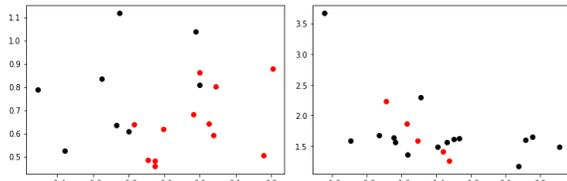

Figure 6. Sample PCA Visualization per Participant showing Visual Differences

Further observing the visualizations with regards to the individual participant data can be seen in Figure 6. The left image, obtained from one participant, seems show that there is a visually observable separation from the truth (black points) and lie (red points) samples of the participant. This could indicate quantitative evidence that the micro-expressions of an individual, when lying, is specific to that individual. This also merits further investigation on user-dependent and user-fold validation techniques as recommendation for future researchers.

4. CONCLUSION

The study performed various techniques from extracting facial landmark points from video frames, performing affine transformation methods of scaling and translation to provide uniformity to the data, implementation of time series processing via MinMaxAve scaling for time intervals with overlap due to the temporal aspect of the data, generate facial feature visualizations representing time using changes in transparency, as well as implementation of basic machine learning algorithms for classifications. Although the accuracy obtained in the study did not exceed 60%, even with simple binary classification, other results show some opportunity for improvement as well as use of the methodology in different applications. With limited dataset and resources, the study is still at its early stages, and more improvement can be made, such as normalizing the samples since the number of truth and lie samples in the data collection is uneven; further transformation of rotation and scaling for the images, since some participants tend to rotate and angle their faces; implementation of Convolutional Neural Network and other Deep Learning algorithms instead of simply using visual observation, and others.

5. REFERENCES

Agrawal , S., & Khatri, P. (2015). Facial Expression Detection Techniques: Based on Viola and Jones algorithm and Principal Component Analysis. 2015 Fifth International Conference on Advanced Computing & Communication Technologies, (pp. 108-112). Haryana. doi:10.1109/ACCT.2015.32

Ekman, P., & Friesen, W. V. (1969). Nonverbal Leakage and Clues to Deception. *Psychiatry: Journal for the Study of Interpersonal Processes*, 32(1), 88-106.

Yan, W.-J., Wang, S.-J., Liu, Y.-J., Wu, Q., & Fu, X. (2014). For micro-expression recognition: Database and suggestions. *Neurocomputing*, 136, 82-87. doi:<https://doi.org/10.1016/j.neucom.2014.01.029>

Zhang, M., Fu, Q., Chen, Y.-H., & Fu, X. (2014). Emotional Context Influences Micro-Expression Recognition. *Plos One*, 9(4). doi:10.1371/journal.pone.0095018



Developing a Prototype for a Microcontroller-Based Coin-Counting Machine

Jean Louis Lance Y. Cabrera, Daenielle D. Cruz, Bentley Andrew Y. Lu
Jorgette Courteney C. Siy, and Clement Y. Ong
De La Salle University Integrated School, Manila

Abstract: Coins have become a significant part of today's economy and are continuously being distributed, along with banknotes, for daily transactions in the most conventional methods. The modernized circulating currency method relies heavily on coin sorting and counting machines to prevent inconsistencies when handling and calculating coins. While the innovation reduces the need for human resources and revolutionizes the way establishments work with large sums of coins, accuracy in differentiating coins becomes an issue in some existing designs. The prototype uses light occlusion and measures the energy of the coin impact to identify the denomination. The prototype shows promise in being able to identify four Philippine coin denominations.

Key Words: coin denomination; coin detection; coin properties; accelerometer sensor; light dependent sensor

1. INTRODUCTION

Coins have had a significant impact on the current currency system of the Philippines. As of March 31, 2019, 31.8 billion pieces of coins valued at 39.5 billion Philippine Pesos have been produced (Bangko Sentral ng Pilipinas, 2019). The Bangko Sentral ng Pilipinas (BSP) ensures that the supply and division of coins are sufficient and non-repetitive (Chipongian, 2019). According to Doza (2018), there was a new update on the currency of the Philippines, which is called the "New Generation Currency (NGC)." The BSP made new coins having millimeters of 20, 16, 15, 23, 25, 27 for the diameters of 25-Centimo, 5-Centimo, 1-Centimo, 1-Peso, 5-Peso, and 10-Peso (Doza, 2018). These new coins have new security features, consisting of an electromagnetic signature embedded and considered (Doza, 2018; Rogers & Thomas, 2017).

As coins are highly used in the country, coin counterfeiters have constantly been trying to abuse this. There are currently two false identification systems used in coin counter machines: mechanical and technological (Delgado, n.d; Hu, n.d.). According to Hu (n.d.), mechanical coin tester mechanisms check the coin's width and weight to determine its denomination and use electromagnetism to identify its coin denomination. According to Delgado (n.d.), technological coin tester mechanisms use image capturing technology or Circular Hough Transform (CHT) to identify its authenticity as it would find all the possible radii to locate the placement of the coin. Afterward, it would utilize the Fisher Linear Discriminant analysis and electromagnetism to identify the coin denominations (Delgado, n.d.). At

present, coin counting machines are still utilizing false identification systems to increase their security and avoid counterfeit coins (Chipongian, 2019). However, according to ABS-CBN News (2017), it was not until March of 2018 when the Light Rail Manila Corporation (LRMC) updated its ticket vending machines four months after the release of the new 5-peso coin.

To solve the problem, a new prototype for a coin-counting machine was proposed. This prototype has an ingenious way of identifying Philippine coins, despite designs varying throughout the years, that are efficient, accurate, and made with quality materials to better its performance. The researchers aim to implement non-image sensing technologies to develop a software that could distinguish coin denominations such as 1-Peso, 5-Peso, 10-Peso, and 20-Peso, based on the sensor data. Coins deliberately altered (mutilated or deformed), damaged (oxidized, worn down), commemorative coins, and centavos cannot be classified or identified as acceptable. The researchers would evaluate the prototype's consistency and speed in distinguishing these various coin denominations.

The findings of this study will greatly benefit those who frequently utilize coins. This prototype serves as a guide for people to improvise ways to identify and distinguish Philippine coins. Also, establishments that usually need to input coins will have a more convenient time as determining coins of different denominations would become timesaving and better in terms of accuracy. Besides this, future researchers can further their knowledge with this prototype acting as a basis for refinement of future works.

2. METHODOLOGY

2.1 Light Dependent Sensor

This sensor consists of a light dependent resistor (LDR) and a light-emitting diode (LED) set to face each other, wherein an uploaded code will solve for the time occluded as the coin passes through (Figure 1). Ten trials were done per coin denomination. After the first ten trials, changes were made to make coin drop more consistent: the use of a coin dropper, the height drop setting (6 cm), and the use of an LM324 following a circuit diagram (Figure 2).

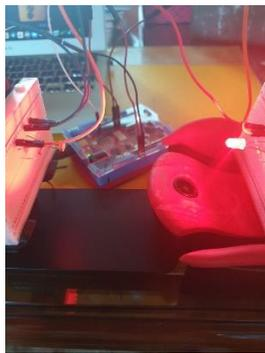

Figure 1. Initial Setup for Light Dependent Resistor.

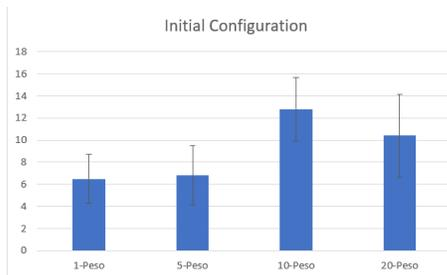

Figure 2. Initial results of Light Dependent Resistor.

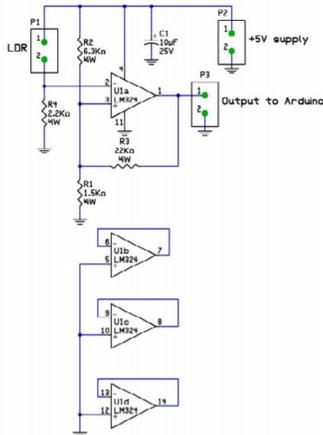

Figure 3. Circuit Diagram for Light Dependent Resistor.

2.2 ACCELEROMETER SENSOR

This MPU-6050 accelerometer is attached to a plate and anchored to two boxes. When a coin is dropped on the plate, the vibrations will be collected using an uploaded code (Figure 4). Ten trials were made per coin denomination. After the first five attempts, the setup for the MPU-6050 was modified to minimize the vibrations and absorb the initial impact made by the coin (Figure 5). The MPU-6050 remained attached to the plate in the redesigned setup — tilted to an angle and placed on the floor. Furthermore, a small chair was positioned with a red circular mark to indicate the height wherein the coin will be dropped (Figure 6).



Figure 4. Initial Configuration for Accelerometer Sensor.

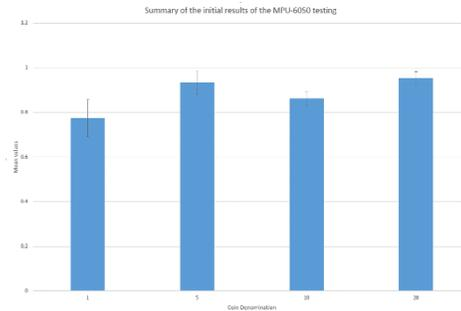

Figure 5. Summary of Initial Results of the Accelerometer Results on the Y-axis.



Figure 6. Final Configuration for the MPU-6050 Sensor.

2.3. Prototype Testing

After conducting and recording the light dependent sensor and accelerometer sensor trials, both sensors were combined into one prototype (Figure 7). Nevertheless, the prototype utilized the same height (6 cm) used for dropping the coin with a coin dropper, while the accelerometer sensor utilized the chair with a circular mark. There were slight changes to enhance the prototype's performance: the addition of another chair, cardboard (to hold the light dependent sensors), and cardboard (on top of the accelerometer sensor).



Figure 7. Prototype Setup.

3. RESULTS AND DISCUSSION

3.1. Light Dependent Sensor

After several trials and alterations, results showed gradual improvements from each adjustment made (Table 1). The light dependent sensor's initial trial had a minimum standard deviation of 2.202, which then changed to 0.539 in the final results. The mean values also went from an indistinguishable set of numbers to a distinguishable and concise set of numbers. Furthermore, coin denominations such as one and five overlapped, while denominations ten and twenty were not overlapping (Figure 8).

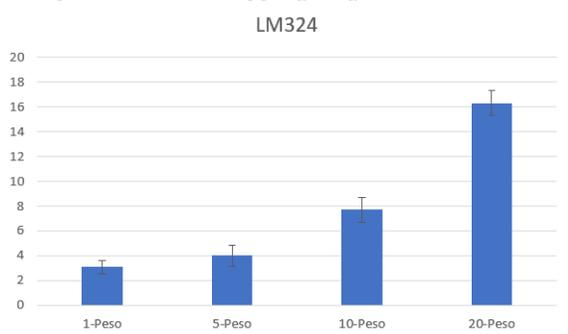

Figure 8. Final results of the light dependent sensor.

Table 1. Results of the Changes of Light Dependent Sensor

		1-Peso	5-Peso	10-Peso	20-Peso
Initial	Mean	6.5	6.8	12.8	10.4
Configuration	Standard Deviation	2.202	2.676	2.891	3.720
Addition of a ruler	Mean	5.9	8.3	10	15.8
Addition of a coin dropper	Standard Deviation	1.135	1.552	1.483	1.720
Final	Mean	10	10.6	12.2	8.2
Setup	Standard Deviation	0.755	1.114	1.400	1.077
	Mean	3.1	4	7.7	16.3
	Standard Deviation	0.539	0.831	1.00	1.00

3.2. Accelerometer sensor

Based on the final results of the MPU-6050 trials, it can be seen that the significant impact of the coin would be on the Y-axis as it is the focal point of the drop, having the values vary significantly (Table 2). However, the X and Z values differ from each denomination. These values were caused by the plastic plate's movement horizontally when impacted by the drop of the coin; therefore, the Y value was considered.

Table 2. Final Results of the MPU-6050 Testing

	Trials				
	1	2	3	4	5
1-Peso					
X	3.78	4.07	4.78	4.00	3.56
Y	0.22	-0.27	0.08	0.05	0.22
Z	-9.73	-11.42	-14.95	-10.96	-10.55
	6	7	8	9	10
X	4.35	4.26	3.75	3.75	1.26
Y	-0.07	0.06	-0.25	-0.04	-0.25
Z	-12.65	-11.96	-11.19	-10.21	-12.98
5-Peso					
X	3.44	3.20	5.97	3.77	3.11
Y	-0.22	-0.15	-0.34	0.06	-0.50
Z	-10.27	-9.47	-17.73	-11.26	-8.78
	6	7	8	9	10
X	3.91	4.20	4.77	4.30	3.09
Y	-0.10	-0.44	-0.21	-0.47	-0.33
Z	-11.33	-12.97	-11.01	-14.04	-10.21
10-Peso					
X	3.65	3.77	4.29	4.32	3.80
Y	-0.35	-0.39	-0.44	-0.54	-0.28
Z	-11.61	-10.41	-11.68	-12.51	-10.44
	6	7	8	9	10
X	4.57	6.55	4.98	3.32	4.15
Y	-0.42	-1.28	-1.36	-0.62	-1.11
Z	-12.70	-17.44	-16.54	-10.77	-15.22
20-Peso					
X	4.65	4.25	5.01	4.15	5.83
Y	-2.65	-3.58	-2.29	-1.07	-1.88
Z	-10.90	-15.35	-8.32	-11.79	-11.05
	6	7	8	9	10
X	2.68	3.56	4.50	4.47	3.46
Y	-3.32	-1.96	-1.56	-1.05	-1.26
Z	-3.65	-6.68	-10.55	-8.05	-7.53



There were more distinct and wide-spread means than the initial results; however, this could be decreased by dropping the coin in a consistent manner (Table 3 & Figure 9).

Table 3. Summary of the Final Results of the MPU-6050 Configuration

Coin	Mean	Standard Deviation
1-Peso	-0.025	0.175
5-Peso	-0.270	0.170
10-Peso	-0.679	0.388
20-Peso	-2.060	0.850

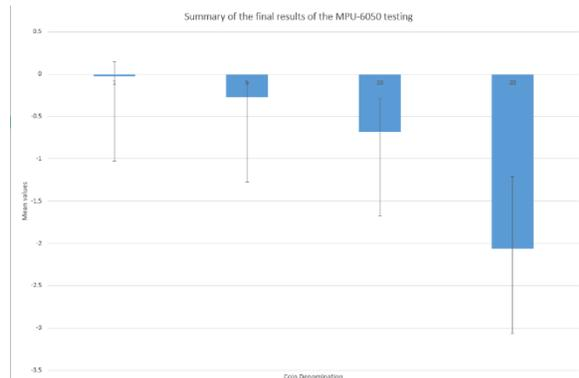

Figure 9. Summary of the Final Results of the MPU-6050 Testing.

3.3. Prototype Testing

The final results of both the light dependent sensor and the accelerometer sensor were utilized as a guide to determine the coin denomination being dropped. However, the results were not similar to the final results due to the variety of ways in coin dropping. Hence, another set of trials were conducted to obtain the sensors' data with the combined setup (Table 4). These values consisted of the time occluded by the coin, the peak value of the y-axis, and the average values around the peak of the y-axis (consists of one value before the peak, the peak itself, and three values after the peak).

Table 4. Results of Prototype Testing

	Trials						
	1-Peso	1	2	3	4	5	
Time Occluded		8	8	8	8	9	
Peak Value		5.75	5.64	5.45	4.73	6.21	
Average Values around the Peak		5.43	3.19	3.32	3.30	4.22	
		6	7	8	9	10	
Time Occluded		8	8	8	8	9	
Peak Value		4.61	6.30	6.15	4.68	3.77	
Average Values around the Peak		2.46	3.65	3.76	2.89	2.84	
		5-Peso	1	2	3	4	5

Time Occluded	9	9	10	9	10	
Peak Value	6.93	7.58	9.25	7.77	9.10	
Average Values around the Peak	4.04	4.79	5.59	4.77	5.79	
	6	7	8	9	10	
Time Occluded	10	10	10	9	11	
Peak Value	9.47	7.31	8.34	6.71	9.68	
Average Values around the Peak	5.27	4.64	5.59	3.85	5.88	
	10-Peso	1	2	3	4	5
Time Occluded	12	12	13	11	13	
Peak Value	9.61	7.74	7.77	7.21	9.72	
Average Values around the Peak	6.28	4.40	4.82	4.55	5.99	
	6	7	8	9	10	
Time Occluded	12	14	13	12	12	
Peak Value	7.26	8.25	9.88	7.75	8.50	
Average Values around the Peak	4.44	4.36	5.97	4.92	5.08	
	20-Peso	1	2	3	4	5
Time Occluded	16	16	16	18	15	
Peak Value	11.23	11.05	18.88	11.00	11.05	
Average Values around the Peak	6.48	6.86	6.09	6.68	7.34	
	6	7	8	9	10	
Time Occluded	16	16	18	16	18	
Peak Value	12.06	10.66	11.92	14.57	12.09	
Average Values around the Peak	7.27	4.77	6.09	8.54	7.86	

Table 5. Summary of the Results of Prototype Testing

	1-Peso	5-Peso	10-Peso	20-Peso
Peak Value: Mean	5.3385	8.214	8.369	12.451
Peak Value: SD	0.8025	1.0454	0.9690	2.3900
Peak Value: Range	4.68 to 6.30	6.71 to 9.47	7.21 to 9.88	10.66 to 18.88
Average Values around the Peak: Mean	3.506	5.021	5.081	6.881
Average Values around the Peak: SD	0.7994	0.6807	0.6946	0.9674
Average Values around the Peak: Range	2.84 to 4.22	3.85 to 5.88	4.40 to 5.99	6.48 to 8.54
Time Occluded: Mean	8.2	9.7	12.4	16.5
Time Occluded: SD	0.4	0.6403	0.8	1.0247
Time Occluded: Range	8 to 9	9 to 11	11 to 14	15 to 18

The summary of the results had shown that the discriminants' hierarchy, from highest to lowest, is the time occlusion, then average values around the peak then peak values (Table 5). With this in mind, the values were simulated in a software that could determine coin denominations (Table 6).

Table 6. Confusion Matrix for Software Simulation

Coin	Coin Reading				
	1-Peso	5-Peso	10-Peso	20-Peso	Not Classified
1-Peso	10	0	0	0	0
5-Peso	0	9	1	0	0
10-Peso	0	0	9	0	1
20-Peso	0	0	0	10	0

Based on the values of Table 6, the simulation showed that the 1-Peso and 20-Peso simulations were correctly identified ten times.



Additionally, the 5-Peso and the 10-Peso simulation were both correctly identified nine times, having one incorrect result as the 5-Peso was recognized as a 10-Peso coin and the 10-Peso coin was not classified. Furthermore, this code was used to simulate ten more trials (Table 7).

Table 7. Confusion Matrix for the Live Simulation

Coin	Coin Reading				
	1-Peso	5-Peso	10-Peso	20-Peso	Not Classified
1-Peso	8	1	0	0	1
5-Peso	0	7	2	0	1
10-Peso	0	1	7	0	2
20-Peso	0	0	0	10	0

It is evident that the simulation can be used to identify coin denominations as it identified 20-Peso coins ten times, 10-Peso and 5-Peso seven times, and 1-Peso eight times, respectively. After further alterations in the code and the setup, the new setup and result can be seen in Figure 10 and Table 8.



Figure 10. Final Setup for the Prototype Testing.

Table 8. Confusion Matrix for the Final Setup

Coin	Coin Reading				
	1-Peso	5-Peso	10-Peso	20-Peso	Not Classified
1-Peso	100	0	0	0	0
5-Peso	0	97	0	0	3
10-Peso	0	0	100	0	0
20-Peso	0	0	0	100	0

As the results of the trials that can be seen in Table 8 improved, fake coins were tested whether they would be detected as any of the denominations. The fake coins that were used were 5 cents, 10 cents, 25 cents, 10 Malaysian sen, a washer, a bigger washer, and a button. The 5 cents, the washer, the bigger and the button were rejected by the setup mechanically. The washer and the bigger washer were wrapped with aluminum foil and were tested again to check whether it was not detected because of the whole between it. The washer was again rejected by the setup, while the bigger washer was detected but not classified as any

coin. On the other hand, the other coin samples were detected but not classified as any denomination. The result can be seen in Table 9.

Table 9. Confusion Matrix for other coin samples

Coin	Coin Reading				
	1-Peso	5-Peso	10-Peso	20-Peso	Not Classified
5-Cent	N/A	N/A	N/A	N/A	N/A
10-Cent	0	0	0	0	100
10 Malaysia Sen	0	0	0	0	100
25-Cent	0	0	0	0	100
Bigger washer wrapped in aluminum foil	0	0	0	0	100
Bigger washer Button	N/A	N/A	N/A	N/A	N/A
Washer	N/A	N/A	N/A	N/A	N/A
Washer wrapped in aluminum foil	N/A	N/A	N/A	N/A	N/A

4. CONCLUSIONS

The prototype setup can distinguish four Philippine coin denominations. Adjustments made to the sensors, electronically and in software, coupled with changes in the mechanical design and layout for the coin drop, contributed to the increasing ability of the prototype to identify the coins. The prototype setup can also distinguish real coins from fake coins.

5. REFERENCES

ABS-CBN News. (2017). LRT-1: ticket vending machines to accept new coins in March 2018. <https://news.abs-cbn.com/business/12/22/17/lrt-1-ticket-vending-machines-to-accept-new-coins-in-march-2018>

Bangko Sentral ng Pilipinas. (2019). Frequently asked questions [PDF FILE]. <http://www.bsp.gov.ph/downloads/Publications/FAQs/banknotes.pdf>

Chipongian, L. (2019). BSP to put coin-counting machines in groceries. Manila Bulletin. <https://business.mb.com.ph/2019/07/16/bsp-to-put-coin-counting-machines-in-groceries>

Delgado, D. (n.d.). Automatic coin and bill detection [PDF FILE]. https://web.stanford.edu/class/ee368/Project_Autumn_1617/Reports/report_delgado.pdf

Doza, E. (2018). BSP ensures security features in new coins. Philippine Information Agency. <https://pia.gov.ph/news/articles/1007048>

Hu, D. (n.d.). How a coin tester works. Report on how things work. https://web.mit.edu/2.972/www/reports/coin_tester/coin_tester.htm

Rogers, S., & Thomas, R. (2017). Detection of the security feature in the new £1 coin [PDF FILE]. <https://www.matlabexpo.com/content/dam/mathworks/mathworks-dot-com/images/events/matlabexpo/uk/2017/detection-of-security-feature-in-new-1-coin.pdf>



COVIDetect: A Desktop Application as a Diagnostic Tool for Novel Coronavirus (COVID-19) Pneumonia in Chest X-ray Images Using Convolutional Neural Network

Vincent A. Arellano, and Michael Angelo C. Tolentino

Philippine Science High School - CALABARZON Region Campus, Batangas City, Batangas

Abstract: The COVID-19 pandemic has heavily affected the well-being of people worldwide. Current diagnostic tools, like the RT-PCR, are expensive and time-consuming; thus, there is a need for cheaper and faster means of COVID-19 detection. This study proposes using a desktop application with a convolutional neural network (CNN) and visual analysis as a supplementary diagnostic tool for detecting COVID-19 pneumonia in chest X-ray images. The CNN used is a sequential Keras model that was trained and tested through eight epochs using an augmented dataset. Random data augmentation techniques applied were rotation and horizontal flipping, which increased the total images used to 13,584. Visual analysis was created using the Grad-CAM algorithm to determine patterns in chest X-ray images. These were implemented in a desktop application and evaluated by a professional pulmonologist. Results showed that the CNN achieved an average accuracy rate of 97.96% among the three classes, which was superior among related studies. The CNN also achieved a precision, recall, and F1-score of 99.67%, 99.62%, and 99.64% respectively for COVID-19 pneumonia, 99.26%, 94.83%, and 96.99% respectively for viral pneumonia, and 95.12%, 99.42%, and 97.22% respectively for normal chest X-ray images. Meanwhile, the visual analysis was also accurate, as evaluated by a professional pulmonologist, where patterns of haziness were determined. Hence, this could serve as an effective supplementary diagnostic tool for healthcare professionals for faster and more accurate diagnosis of COVID-19 and viral pneumonia patients.

Key Words: COVID-19; pneumonia; convolutional neural network; chest x-ray image; desktop application; Grad-CAM

1. INTRODUCTION

The Novel coronavirus or COVID-19 has become a global pandemic since 2020, caused by the severe acute respiratory syndrome coronavirus 2 (SARS-CoV-2) (Gunraj et al., 2020). The World Health Organization, as cited by Khan et al. (2020), stated that a patient that is positive for COVID-19 may develop symptoms such as fever and dry cough, pneumonia, multi-organ failure, chest pain, loss of speech or movement, and death upon infection.

As of the present, several testing methods are used in testing COVID-19 among the possible carriers of the virus. However, these tests can be quite inaccurate as the most used testing method which is the RT-PCR test has a sensitivity rate of 71% to 98% and a specificity rate of 98% to 100% in COVID-19 diagnosis (Agarwal et al., 2020). Hence, there is a need for faster and more efficient means for COVID-19 detection.

Recently, studies have been done to further detect and analyze COVID-19 pneumonia using deep learning through chest X-ray images. Wang et al.

(2020) suggested that chest X-rays are faster to operate than RT-PCR kits which take days to get results. The presence of X-ray machines in medical facilities adds to the availability and accessibility of the said testing method. Testing can also be done in a fixed X-ray machine instead of transporting the test kits from one location to another. However, present research on automated detection of COVID-19 pneumonia using deep learning techniques were challenged by the insufficient amount of identifiable chest X-rays since the outbreak was recent, possibly causing overfitting in some neural networks that would yield less accurate results.

Thus, this research study aimed to develop a convolutional neural network trained on an augmented dataset, implemented through a desktop application with visual analysis, as a low-cost, automatic, supplementary diagnostic tool for novel coronavirus (COVID-19) pneumonia and viral pneumonia from chest X-ray images utilizing deep learning techniques. Data augmentation will be implemented to a chest X-ray dataset to produce more

images with different variations and obtain more accurate results.

To support this, the effectiveness of the developed model in terms of accuracy, precision, sensitivity, and F1 score in detecting the COVID-19, viral pneumonia and normal chest X-Ray images was determined. Additionally, the accuracy of the developed model was compared to other existing CNN models or architectures that also detected the same diseases. A qualitative feedback on the desktop application from an expert pulmonologist was also obtained to further assess its effectiveness.

This study may be deemed significant to COVID-19 positive patients as they can have a real-time assessment of the status of COVID-19 pneumonia if they are symptomatic. Also, medical frontliners, radiologists, and specialized virology doctors, can be greatly assisted through fast and automated detection of COVID-19 pneumonia by analyzing X-ray images among possible COVID-19 positive patients. Along with this, hospitals and specialized COVID-19 facilities can be benefited from this research as automated COVID-19 pneumonia detection can be done using X-rays and computers which are readily available across most health establishments.

2. METHODOLOGY

2.1. Development of Augmented Dataset

The dataset utilized in this study is the COVID-19 Radiography Database developed by Chowdhury et al. (2020), which is made up of 1200 COVID-19 pneumonia, 1,345 viral pneumonia, and 1,341 normal chest X-ray images. To maximize the size of the dataset, data augmentation was applied using scikit-image, where two transformational techniques were utilized: rotation and horizontal flipping. Using data augmentation, overfitting is significantly reduced from image processing models (Gunraj et al., 2020). This resulted in an augmented dataset that is composed of 13,584 chest X-ray images, as seen in Table 2.1.

Table 2.1. Number of Images Before and After Data Augmentation of the Dataset.

	Number of Images Before Augmentation	Number of Images After Augmentation
COVID-19 Pneumonia	1200	4205
Viral Pneumonia	1345	4697
Normal	1341	4682
Total	3886	13,584

2.2. Development of the Convolutional Neural Network (CNN)

A sequential CNN was constructed using Keras and Tensorflow, where its architecture is seen in Figure 2.1. The chest X-ray is inputted in the model and enters the rescaling layer, where its dimension is resized to 256 x 256. Afterward, it undergoes 3 repetitions of a convolutional layer and a max-pooling layer. A convolutional layer extracts the features from the images. Meanwhile, a max-pooling layer attains the maximum element from the feature map extracted by the convolutional layer. Lastly, it undergoes two dense or fully connected layers, which takes the output of the previous layers, then flattens and converts them into a single vector. The probability for each class is then calculated.

After constructing the convolutional neural network, the model ran through eight epochs for training and testing. 80% of the dataset was utilized for training the model, while the remaining 20% was utilized for testing the model.

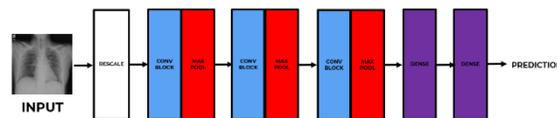

Figure 2.1. CNN Architecture of the Model

2.3. Development of the Desktop Application with Visual Analysis

The developed CNN was implemented through a desktop application using Tkinter. The user interface, as seen in Figure 2.2, shows the draft of the elements of the desktop application. The “Upload Chest X-ray Image” button allows users to upload chest X-ray images to be classified among the three groups. Once uploaded, the image would be seen in the left region, while a visual analysis using Gradient-weighted Class Activation Mapping (Grad-CAM) is provided on the right. The results of the classification would be provided at the classification label at the bottom side of the application.



Figure 2.2. General User Interface of the Desktop Application

2.4. CNN and Desktop Application Evaluation

To assess the performance of the convolutional neural network, the following specific



metrics were obtained: True Positives (TP), True Negatives (TN), False Positives (FP), and False Negatives (FN). These were visualized using a confusion matrix, which showed the true values of the specific metrics by arranging the data in terms of its classification.

Afterward, the following performance metrics were calculated: accuracy, precision, sensitivity and F1 score. These performance metrics assess the performance and effectiveness of the developed model in classifying the chest X-ray images. The formulas for these performance metrics are:

$$\text{Accuracy} = (\text{TP} + \text{TN}) / (\text{TP} + \text{TN} + \text{FP} + \text{FN})$$

$$\text{Precision} = \text{TP} / (\text{TP} + \text{FP})$$

$$\text{Recall} = \text{TP} / (\text{TP} + \text{FN})$$

$$\text{F1 Score} = 2 \times (\text{Recall} \times \text{Precision}) / (\text{Recall} + \text{Precision})$$

The average accuracy of the model was then compared to the average accuracy of other studies that classify the same groups.

Meanwhile, to assess the performance of the desktop application, a professional pulmonologist tested the application and evaluated it through an interview.

3. RESULTS AND DISCUSSION

The confusion matrix in Table 3.1 showed that the model predicted most chest X-ray images correctly. Therefore, it could be said that the developed model is successful in classifying these images efficiently since convolutional neural networks have the property of extracting similar features or patterns in the chest X-ray images (Khan et al., 2020). The convolutional layers in the model serve as successive filters in detecting significant features in an image. Meanwhile, max-pooling layers reduce the complexity of the image by returning only the maximum value of sub-regions in the image. Lastly, fully connected or dense layers are connected to previous layers and flatten the previous output to convert it into a single vector (Albawi et al., 2018).

Table 3.1. Confusion Matrix Result of COVIDetect in Classifying COVID19, Viral Pneumonia, and Normal Chest X-ray Images

		Predicted Value		
		COVID19	Viral Pneumonia	Normal
True Value	COVID19	4189	8	8
	Viral Pneumonia	12	4454	231
	Normal	2	25	4655

■ Correctly Classified Images
 ■ Misclassified Images

Overall, it has been observed that the convolutional neural network performed efficiently in classifying these images, where performance metrics obtained were above 90% for all classifications as seen in Table 4.2.

Table 4.2. Performance Metrics of the CNN in Classifying COVID-19, Viral Pneumonia, and Normal Chest X-ray Images

Class	Precision / Specificity	Recall / Sensitivity	F1 score	Average Accuracy
COVID-19	99.67%	99.62%	99.64%	97.96%
Viral Pneumonia	99.26%	94.83%	96.99%	
Normal	95.12%	99.42%	97.22%	

The high precision rate of 99.67% for COVID-19 is essential since this indicates that there would be fewer false-positive cases of misclassified COVID-19 diagnosis. Meanwhile, the high recall rate of 99.62% for COVID-19 is also necessary since this indicates that there would be less false-negative diagnosis of COVID-19. Decreasing the chances of these types of misdiagnosis would further decrease the spread of the COVID-19 virus in the community through immediate and proper detection (Wang et al, 2020). Meanwhile, high performance metrics were also obtained by the convolutional neural network for viral pneumonia and normal chest X-ray images, implying that it would also be less likely to misdiagnose normal patients and those with viral pneumonia.

The average accuracy of the developed model was then compared to related studies that detect the same classifications, as seen in Table 4.3. It has been observed that the results obtained by the model were relatively higher compared to other studies that detect the same three classes.

Table 4.3. Comparison of Average Accuracy with Other Related Studies

Study	Architecture	Average Accuracy for Three Classes (%)
COVIDetect	Keras	97.96%
Apostolopoulos et al.	Sequential VGG-19	93.48%
Wang et al.	COVID-Net	93.3%
Apostolopoulos et al.	MobileNet v2	92.85%
Apostolopoulos et al.	Inception	92.85%
Apostolopoulos et al.	Xception	92.85%
Apostolopoulos et al.	Inception ResNet v2	92.85%
Khan et al.	CoroNet	89.60%

Despite using a simpler convolutional neural network, the obtained average accuracy in detecting



the three classes was the highest among related models. This is possibly caused by the sequential neural network being trained on an augmented dataset.

Related studies face the challenge of using an insufficient number of COVID-19 chest X-ray images due to limited data available since the pandemic was recent. It could be observed that most studies that attained a relatively lower average accuracy used fewer images for training and testing their models. Apostolopoulos et al. (2020) made use of 305 COVID-19, 2780 pneumonia, and 1583 normal chest X-ray images for the use of 4 of their model architectures that attained 93.48% for VGG-19 and 92.85% for MobileNet v2. Inception, Xception, and Inception ResNet v2. Meanwhile, Khan et al. (2020) made use of 290 COVID-19, 327 viral pneumonia, and 310 normal chest X-ray images.

Through using data augmentation and developing an augmented dataset, this limitation is resolved. In a study by Wang & Perez (2017), they explored the use of data augmentation in the field of deep learning. Models that made use of small datasets often encounter overfitting since these do not generalize data well. Through data augmentation, more data is generated from the training data for an algorithm to perform better.

Through an evaluation of the COVIDetect desktop application by a professional pulmonologist, he stated that it accurately classifies COVID-19 and viral pneumonia, while there were minor misclassifications for normal chest X-ray images where these were misidentified as viral pneumonia. These misclassifications could be attributed to the haziness present in some normal chest X-ray images that were similar to those with viral pneumonia. Meanwhile, the visual analysis using Grad-CAM was also evaluated as accurate since the red spots effectively cover affected areas or areas with haziness.

Asides from the features of the desktop application, its usability and design were also assessed, and the professional pulmonologist stated that the application was simple, practical, and easy to use. He recommends adding the personal details of patients such as name and age, as well as including bacterial pneumonia in the application's classification.

4. CONCLUSION

Based on the gathered results and findings of the study, the following conclusions were drawn. First, the developed model achieved an average accuracy of 97.96% for detecting COVID-19 pneumonia, viral pneumonia, and normal chest X-ray images. Specifically, it achieved a precision, recall, and F1-score of 99.67%, 99.62%, 99.64% respectively for COVID-19 pneumonia, 99.26%, 94.83%, 96.99%

respectively for viral pneumonia, and 99.26%, 94.83%, 96.99% respectively for normal chest X-ray images. Second, the developed model achieved the highest average accuracy compared to other related studies that detect the same classifications, mainly attributed to the CNN being trained on an augmented dataset. Lastly, the COVIDetect desktop application was evaluated by a professional pulmonologist and its CNN was assessed as accurate with minor misclassifications, while its visual analysis was also assessed as accurate since it effectively covers all affected areas with haziness. The application was also determined to be simple, practical, and easy to use.

Future studies might consider using different architectures for the construction of their CNN. It is also recommended to further expand the scope of the study by including bacterial pneumonia classification and detection of other COVID-19 variants such as the UK variant and P3 variant. Future researchers might also determine the severity of COVID-19 present in the chest X-ray images so people with severe COVID-19 disease can easily be diagnosed. Furthermore, other related methods which are equally available and accessible as chest X-ray image classification can be explored by future researchers. The study can also be improved once more training data are publicly available.

5. ACKNOWLEDGEMENTS

The researchers wish to extend their deepest gratitude and utmost appreciation and recognition to the following persons and institutions who have helped us in the finalization and completion of this research manuscript.

Dr. Allen Roxas, an expert pulmonologist at Mary Mediatrix Medical Center (MMMC) in Lipa City, for his valuable clarifications, insights, suggestions, recommendations, and additional knowledge that he has provided us during the interview with him as part of our methodology. The researchers are also grateful for him because of his accommodation and help in fulfilling one part of our methodology.

Ms. Amy U. Aclan, research adviser of the researchers, for her honest remarks and criticisms on the study that inspired the researchers to improve the desktop application and the research paper, and for her patience in checking and reviewing our manuscript throughout the research process.

Mrs. Cladys M. Falcunaya, research teacher of the researchers, for her consistent emotional support and constructive criticisms and suggestions regarding the study that helped the researchers to pursue this research study on a higher note.

Mr. and Mrs. Vicente and Imelda Arellano and Mr. and Mrs. Mon and Noemi Tolentino, the parents of the researchers, for their unending support



and encouragement to the researchers in fulfilling their research requirements and responsibilities.

And most importantly to PSHS CALABARZON Region Campus, for their provision of high-quality research facilities and professionals to work with in accomplishing all the tasks needed for the completion of the research manuscript.

6. REFERENCES

- Agarwal, N., Raheja, A., & Suri, A. (2020). Guidelines for Preoperative Testing for Neurosurgery in COVID-19 Era: Indian Viewpoint Amidst Global Practice. *World Neurosurgery*.
- Albawi, S., Mohammed, T. A., & Al-Zawi, S. (2018). Understanding of a convolutional neural network. *Proceedings of 2017 International Conference on Engineering and Technology, ICET 2017, 2018-Janua*, 1–6. doi: 10.1109/ICEngTechnol.2017.8308186
- Apostolopoulos, I. D., & Mpesiana, T. A. (2020). Covid-19: automatic detection from X-ray images utilizing transfer learning with convolutional neural networks. *Physical and Engineering Sciences in Medicine*, 43(2), 635–640. doi: 10.1007/s13246-020-00865-4
- Böger, B., Fachi, M. M., Vilhena, R. O., Cobre, A. de F., Tonin, F. S., & Pontarolo, R. (2020). Systematic review with meta-analysis of the accuracy of diagnostic tests for COVID-19. *American Journal of Infection Control*. doi:10.1016/j.ajic.2020.07.011
- Chouhan, V., Singh, S. K., Khamparia, A., Gupta, D., Tiwari, P., Moreira, C., Damaševičius, R., & de Albuquerque, V. H. C. (2020). A novel transfer learning-based approach for pneumonia detection in chest X-ray images. *Applied Sciences (Switzerland)*, 10(2). <https://doi.org/10.3390/app10020559>
- Chowdhury, M. E. H., Rahman, T., Khandakar, A., Mazhar, R., Kadir, M. A., Mahbub, Z., Islam, M. T. (2020). Can AI Help in Screening Viral and COVID-19 Pneumonia? *IEEE Access*, 8, 132665–132676. <https://doi.org/10.1109/ACCESS.2020.3010287>
- Fang, Y., Zhang, H., Xie, J., Lin, M., Ying, L., Pang, P., & Ji, W. (2020). The sensitivity of Chest CT for COVID-19: Comparison to RT-PCR. *Radiology*, 296(2). <https://doi.org/10.1148/radiol.2020200432>
- Gunraj, H., Wang, L., & Wong, A. (2020). COVIDNet-CT: A Tailored Deep Convolutional Neural Network Design for Detection of COVID-19 Cases from Chest CT Images. 1–12. Retrieved from <http://arxiv.org/abs/2009.05383>
- He, K., Zhang, X., Ren, S., & Sun, J. (2016). Identity mappings in deep residual networks. *Lecture Notes in Computer Science (Including Subseries Lecture Notes in Artificial Intelligence and Lecture Notes in Bioinformatics)*, 9908 LNCS, 630–645. https://doi.org/10.1007/978-3-319-46493-0_38
- Khan, A. I., Shah, J. L., & Bhat, M. M. (2020). CoroNet: A deep neural network for detection and diagnosis of COVID-19 from chest X-ray images. *Computer Methods and Programs in Biomedicine*, 196, 105581. <https://doi.org/10.1016/j.cmpb.2020.105581>
- Magsambol, B. (2020, May 25). FAST FACTS: What's the difference between PCR, rapid antibody tests? Retrieved November 26, 2020, from <https://www.rappler.com/newsbreak/iq/things-to-know-polymerase-chain-reaction-rapid-anti-body-tests>
- Mahmud, T., Rahman, M. A., & Fattah, S. A. (2020). CovXNet: A multi-dilation convolutional neural network for automatic COVID-19 and other pneumonia detection from chest X-ray images with transferable multi-receptive feature optimization. *Computers in Biology and Medicine*, 122(June), 103869. <https://doi.org/10.1016/j.combiomed.2020.103869>
- Rahman, T., Chowdhury, M. E. H., & Khandakar, A. (2020). Transfer Learning with Deep Convolutional Neural Network (CNN) for Pneumonia Detection Using Chest X-Ray.
- Rajpurkar, P., Irvin, J., Zhu, K., Yang, B., Mehta, H., Duan, T., Ding, D., Bagul, A., Ball, R. L., Langlotz, C., Shpanskaya, K., Lungren, M. P., & Ng, A. Y. (2017). CheXNet: Radiologist-level pneumonia detection on chest X-rays with deep learning. *ArXiv*, 3–9.
- Shibly, K. H., Dey, S. K., Islam, M. T. U., & Rahman, M. M. (2020). COVID faster R-CNN: A novel framework to Diagnose Novel Coronavirus Disease (COVID-19) in X-Ray images. *Informatics in Medicine Unlocked*, 20, 100405. <https://doi.org/10.1016/j.imu.2020.100405>
- Sirazitdinov, I., Kholiavchenko, M., Mustafaev, T., Yixuan, Y., Kuleev, R., & Ibragimov, B. (2019). Deep neural network ensemble for pneumonia localization from a large-scale chest x-ray database. *Computers and Electrical Engineering*, 78, 388–399. <https://doi.org/10.1016/j.compeleceng.2019.08.004>
- Wang, J., & Perez, L. (2017). The effectiveness of data augmentation in image classification using deep learning. *ArXiv*.
- Wang, L., Lin, Z. Q., & Wong, A. (2020). COVID-Net: a tailored deep convolutional neural network design for detection of COVID-19 cases from chest X-ray images. *Scientific Reports*, 10(1), 1–12. <https://doi.org/10.1038/s41598-020-76550-z>
- World Health Organization. Philippines: WHO Coronavirus Disease (COVID-19) Dashboard. (2020). Retrieved October 01, 2020, from <https://covid19.who.int/region/wpro/country/ph>
- World Health Organization. WHO Coronavirus Disease (COVID-19) Dashboard. (2020). Retrieved October 01, 2020, from <https://covid19.who.int/>



Design and Analysis of a Myoelectric Arm Prosthesis for Transradial Amputees working as Auto-Mechanics

Azzam Afghani P. Alonto, Christian Ericson P. Delos Santos, Aaron Randall Jardenil
and Alan Miguel Joaquin M. Ocho
De La Salle University Integrated School, Manila

Abstract: Amputees struggle to function because of the large degree of dependence they need to execute basic tasks that people could normally do. Amputees usually opt to use a prosthesis, for cosmetic and other functional reasons, which are not often made for situations with intense physical exertion such as the workplace. Thus, this study aims to create a mechanical arm prosthesis design that is occupationally suitable for transradial amputees. The device is mostly made of acrylonitrile butadiene styrene (ABS), a type of thermoplastic. A digital model of the prosthesis, divided into three subassemblies, was created via Autodesk Inventor. These then went through Finite Element Analysis in which a 400 N load was placed to simulate a pushing force. After the simulations, it was proven that the individual subassemblies can withstand the specified force with minimal displacement and without yielding which shows that larger forces could be exerted. This also shows that ABS is a suitable material for creating such assistive devices. Further study could be made by optimizing the geometry and changing the orientation of the loads.

Key Words: pwds; transradial amputees; prosthetics; assistive device; finite element analysis

1. INTRODUCTION

Currently, there are about 1.44 million people with disabilities (PWDs) in the Philippines (Philippine Statistics Authority, 2013). According to Mina (2013), 93 out of 123 persons with mobility impairment in urban areas are either underemployed, unemployed, or apart from the labor force. It is inferable based on this data that there is a substantial number of people with missing limbs in the Philippines, either congenitally or externally, who have a difficult time getting a steady source of income.

In specifically the case of upper limb amputees, there are different situations where a person would need to get an upper limb (arms, wrists, or hands) amputated. Indications include trauma beyond repair, irreparable loss of the blood supply of that limb, malignancy, severe contracture, infection, congenital deformities, burns, electrical injury, frostbite, and complications from diseases (Maduri & Akhondi, 2018). As for the causes of these indications, except for the disease and congenital related ones, some common examples would be machinery accidents, infrastructural accidents, as well as military and athletic injuries. For these patients to cope with daily life despite their limb loss, various types of prostheses were developed.

Transradial and Congenital Transradial Amputation both refer to the loss or the absence of the forearm or anything below it, including the wrist and the hand (Ovadia & Askari, 2015). The only difference

is that the former refers to an accident or an unnatural amputation caused by outside factors, and the latter refers to a birth defect. To assist people with this condition, prostheses are developed.

A prosthesis, which is an artificial device that replaces a missing body part (Strait, 2006), was designed to solve this problem and help PWDs be more financially and physically independent. Its structural integrity was analyzed through finite element analysis. ABS or acrylonitrile butadiene styrene, a thermoplastic aliphatic polyester derived from renewable sources, was the set material for the prototype. Additionally, it utilized sensors that monitor nerve activity in muscles, known as Electromyography sensors (Vigotsky et al., 2018), to aid in its functionality. The model was constructed in Autodesk Inventor and virtually tested in Autodesk Nastran In-CAD. The prosthesis design is made for a person who is a transradial or congenital transradial amputee.

2. METHODOLOGY

2.1. Prosthesis Design

The arm prosthesis was created through Autodesk Inventor, which is a computer-aided design (CAD) software that excels in manufacturing modeling. The design process was divided into two main parts: the extension, which is the main load-bearing structure, and the terminal end, which is the

tool. The extension was primarily made of ABS and its length was based on the arm dimensions of an average Filipino man. As stated in a study by Rahmann, et al. (2018), the average forearm-to-hand length for Filipinos is 44.1cm, while the average hand length is 19.8 cm. Other dimensions such as stump length, arm diameter near the elbow, and wrist diameter were based on a sample arm with dimensions 15 cm, 9 cm, and 7 cm respectively. Though there are no maximum dimensions as to how long the stump should be, the 15 cm length was chosen as it provides enough space for the other internal components of the device without surpassing the average forearm length. The aforementioned dimensions of the prosthetic were utilized for experimentation, but the design will be made adaptable when it is set for public use. This means that the dimensions of the device, particularly the forearm length and diameters, will change to enhance the cosmetic appearance of the amputee's arm and the contact of the device to the stump. Additionally, a stretchable socket and an adjustable harness will be used to cater to the varying sizes of the arm stump and circumference. However, this was not presented in the virtual model as it is not needed in the finite element analysis. Moreover, the tool (wrench) was designed to have an effective length of 49.16 cm since it mimics the effective length of the hand combined with a model car wrench of 40 cm.

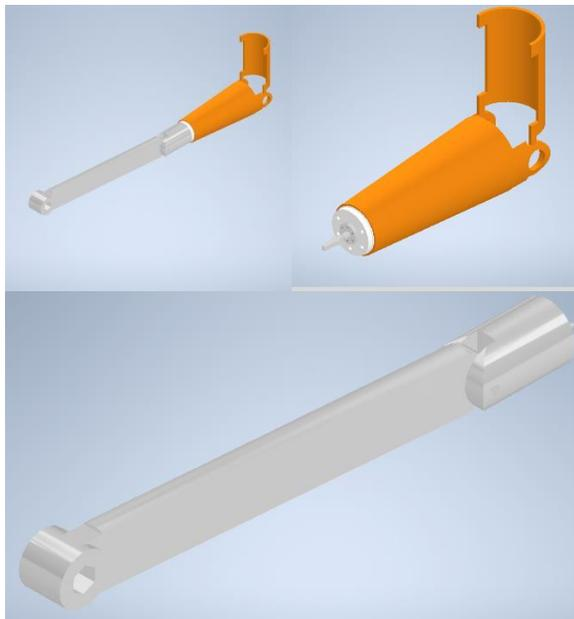

Fig 1. Full assembly of prosthetic arm (left), assembly of extension (right), assembly of sample tool (bottom)

2.2. Finite Element Analysis

The design of the prototype was only tested through virtual means with the use of Autodesk Nastran In-CAD software, which was chosen since it

is directly integrated within the modeling software. The main test involved was the linear stress tests wherein the load-bearing components of the prosthesis were analyzed by subassemblies. There are three subassemblies: the exterior shell, the motor with a shaft extension, and the sample tool, which were highlighted as orange, white, and gray in Figure 1 respectively. For each subassembly, their respective constraints, connections, and areas of load application were defined. A force of 400 N was applied as a pushing force since it is the force required to produce a torque of 145 ft/lbs when using the sample tool. The chosen torque is considered to be the maximum torque required to tighten and remove a lug nut from a car tire (Tirerack, 2021). The torquing of lug nuts is a common task in auto-mechanics, specifically in vulcanizing, hence becoming the chosen force. These loads will be applied longitudinally to simulate a pushing force to determine whether the design can tolerate the applied forces. The basis of a successful model was determined on two types of analyses: (a) von Mises stress test, and (b) safety factor. All areas of the model must retain a von Mises stress value lower than the material's stress yield. Additionally, the safety factor must verify the structural integrity of the model by providing a value greater than 1. Any unsatisfied condition would indicate that the model has yielded and must undergo modifications. These parts were not tested as a full assembly due to the limitations of the software. Further characterization is applied by analyzing displacement results.

3. RESULTS AND DISCUSSION

3.1. Analysis of Exterior Shell Subassembly

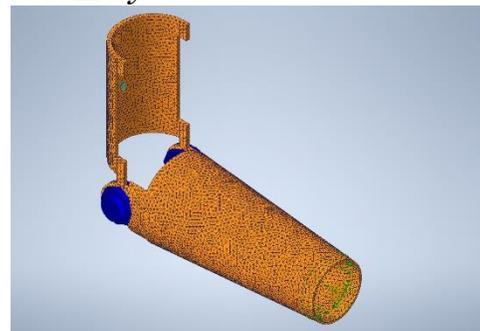

Fig 2. Specified constraints, loads, connections, and generated mesh for exterior shell subassembly

The subassembly presented in Figure 2 consists of two joined pieces wherein the vertical piece rests on the upper arm and the horizontal piece is where the stump is inserted. These two parts are joined by a bolt (presented as a blue entity in Figure 2) that is aligned with the elbow joint. The length of

the horizontal piece is 243 mm, which was achieved by obtaining the difference of the average hand-to-forearm length and average hand length as presented by Rahmann, Dawal, Yusoff, and Kamil (2018). The diameter of the hole at the rear end of the piece is 90 mm while the diameter at the front end is 70 mm. These dimensions were determined by the model arm. Additionally, the thickness of the material is consistently 5 mm thick in both components. The location and direction of the applied load are seen at the terminal end heading inward the horizontal component as represented by the green arrows in Figure 2.

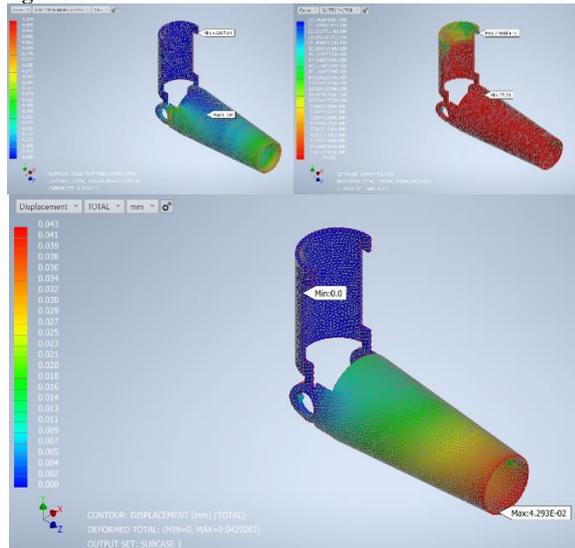

Fig 3. von Mises stress analysis (left), safety factor analysis (middle), and displacement analysis (right) of exterior shell subassembly

The material used for both components is ABS, which has a yield stress (point of shift from elastic to plastic deformation) of 20 MPa. It has a Young's modulus of 2240 and Poisson's ratio of 0.38. As seen in Figure 3, the maximum stress experienced by the model is 1.034 MPa, which is significantly lower than the yield stress. This indicates that the component would be able to withstand greater forces. Additionally, the minimum value of the safety factor analysis is far beyond 1, giving a value of 27.23. Such value would imply that the structure has no risk of yielding and is safe for use under the applied force. The displacement analysis as presented in Figure 3 shows that there is minimal deformation throughout the model. Since the maximum value, indicated by red zones in the analysis, is 0.043 mm, then it is suitable to describe that the subassembly is highly stable.

3.2. Analysis of Motor with Shaft Extension Subassembly

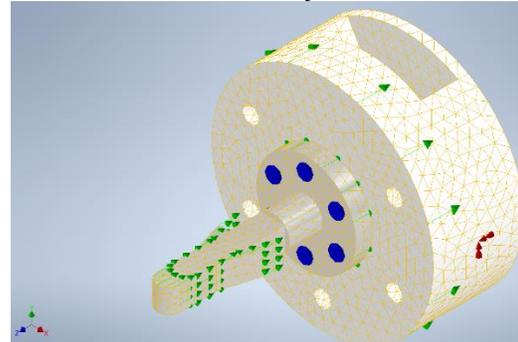

Fig 4. Specified constraints, loads, connections, and generated mesh for motor subassembly

The subassembly as presented in Figure 5 is composed of three components: (a) motor casing, (b) servo motor, and (shaft extension). The motor casing is where the servo motor fits for it to be attached to the exterior shell. Its outer surface is where the constraints are placed (as marked by the red arrows in Figure 4) due to its connection to the previous subassembly. The outer radius of the casing is 70 mm and the inner radius is 30 mm in order to fit the motor. Due to the short shaft of the motor, with a measurement of 12.4 mm, a shaft extension made of steel was added. Screws (as depicted blue in Figure 4) we used at the base of the extension to connect the extension to the shaft. Moreover, the geometry of the shaft extension is wide at half of its length so that it would serve the purpose of being part of the locking mechanism. All the components were identified to be made of steel in the finite element analysis software. The load is applied on the entire front surface as represented by the green arrows pointing towards the rear end in Figure 4.

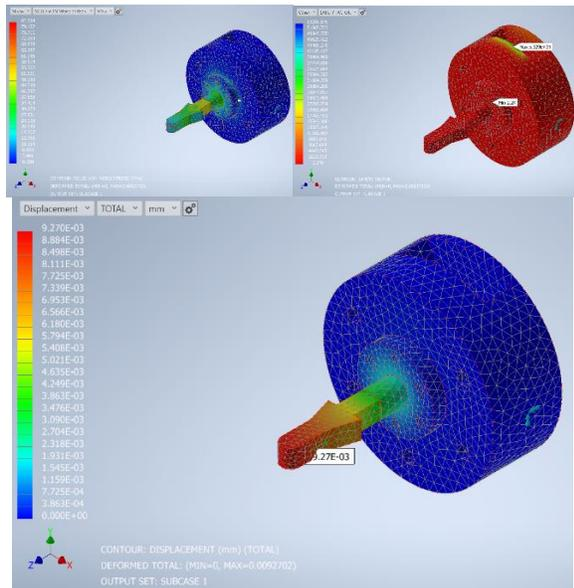

Fig 5. von Mises stress analysis (left), safety factor analysis (middle), and displacement analysis (right) of motor subassembly

With the material set to steel, its modulus of elasticity, Poisson’s ratio, and yield strength are 210000, 0.3, and 207 MPa respectively. The solid von Mises stress analysis shows that the maximum stress value is 82.594 MPa, which satisfied the first condition for the success of the subassembly. It is, however, important to observe that the area with the most stress is located at the surface of the motor, which would indicate that modifications could be made to distribute the force around the casing instead of the electrical component. Nonetheless, the current state of the model is still safe as it bears a safety factor above 1. Moreover, the displacement analysis as seen in Figure 5 shows that the force applied exerts negligible displacement since the greatest displacement experienced within the subassembly is 0.009371 mm. This would indicate that the model could handle slightly higher forces above 400 N.

3.3. Analysis of Sample Tool Subassembly

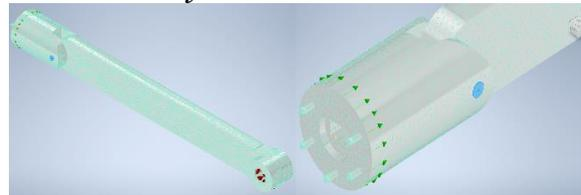

Fig 6. Specified constraints, loads, connections, and generated mesh for sample tool subassembly

The sample tool subassembly consists of three parts: (a) the rear, (b) the pin, and (c) the terminal device. The rear is the part of the tool that bears the locking mechanism which connects to the shaft extension. This is where the force is exerted as shown by the green arrows in Figure 6. It has a hole at the center where the shaft inserts and several protruding structures that connect with the holes on the motor casing. This improves the contact and load distribution between the surfaces of the subassemblies. The terminal device bears the actual tool that encloses the lug nut. The hole at the end acts as the constraint (as marked by the red arrows in Figure 6) since the lug nut is stiff prior to removing it. The two aforementioned parts are connected by a pin, which is highlighted in blue as seen in Figure 6.

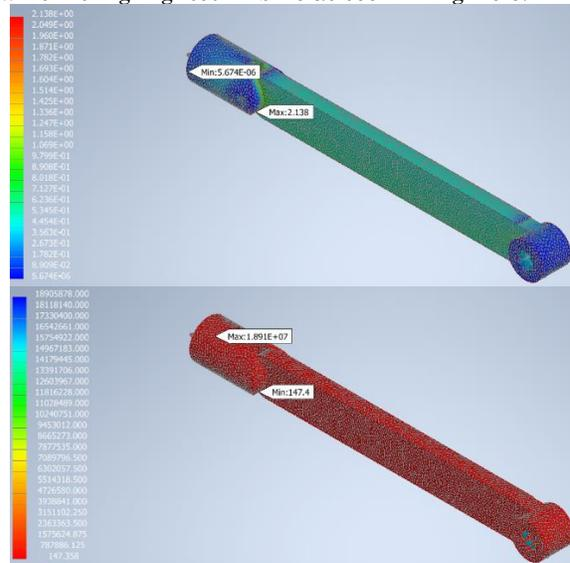

Fig 7. von Mises stress analysis (left), and safety factor analysis (right) of sample tool subassembly

All components of the sample tool are made of steel, which indicates that their Young’s modulus, Poisson’s ratio, and yield strength are 210000, 0.3, and 207 MPa respectively, similar to the specifications of the material properties in the previous subassembly.

As seen in Figure 7, the maximum stress experienced by the model is 2.138 MPa, which is significantly lower than the material's yield strength. This indicated that greater pushing forces could be exerted before the subassembly breaks. However, the concentrated area of relatively high stress at the pin indicates that further distribution of load if significantly greater forces will be applied. Though that is a reasonable observation, the minimum safety factor, which is 147.4, is also located at the pin. This shows that the model, especially the pin, can handle larger forces above 400 N since the minimum value is far beyond 1.

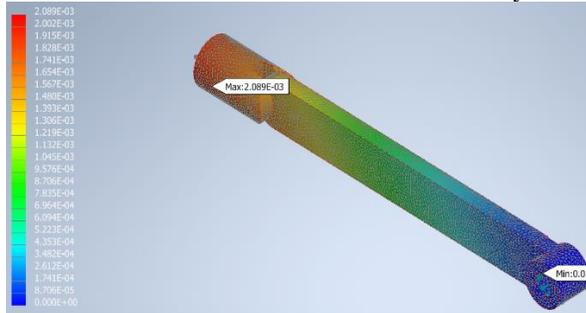

Fig 8. Displacement analysis of sample tool subassembly

The minuscule displacements presented in Figure 8 indicate that the subassembly is barely affected by the applied pushing force despite the long and slender terminal end. Though all indicators imply that the tool can handle the stress, the different angles the tool may be oriented would portray different results, which may affect the stress and displacement values of the device. Moreover, different directions of load application would also lead to varying displacement results. These situations, however, are no longer within the scope of the study but may be used for future studies.

4. CONCLUSIONS

The arm prosthesis design made for auto-mechanics is feasible since it can withstand one of the common forces exerted in car maintenance, namely the tightening and loosening of lug nuts. The individual subassemblies prove that their respective geometries and materials are able to withstand the applied force without significant displacements and yielding. Additionally, the ability of the exterior shell made of ABS to sustain the exerted force implies that it can be used as an alternative when creating arm prostheses. For further study, it is recommended to optimize the geometry of the components to disperse the load over a greater area. Additionally, different load orientations and tool orientations would be recommended to fully characterize the deformations and stress contours of the created prosthetic.

5. ACKNOWLEDGMENTS

We would like to thank our adviser Engr. Michael Manguerra for his continuous support and optimism throughout our work with this study. Even though the pandemic worsened conditions for almost everyone, he was still able to advise us properly and even help us gather our materials within the campus.

6. REFERENCES

Abd Rahman, N. I., Md Dawal, S. Z., Yusoff, N., & Mohd Kamil, N. S. (2018). Anthropometric measurements among four Asian countries in designing sitting and standing workstations. *Sādhanā*, 43(1). <https://doi.org/10.1007/s12046-017-0768-8>

Mina, C. D. (2003). Philippine Institute for Development Studies. <https://pidswebs.pids.gov.ph/ris/dps/pidsdps1313.pdf>

Ovadia, S., & Askari, M. (2015). Upper Extremity Amputations and Prosthetics. *Seminars in Plastic Surgery*, 29(01), 055–061. <https://doi.org/10.1055/s-0035-1544171>

Philippine Statistics Authority. (2013, January). *Psa.gov.ph*. <https://psa.gov.ph/content/persons-disability-philippines-results-2010-census>

Maduri, P., & Akhondi, H. (2019, May 18). Upper Limb Amputation. *Nih.gov; StatPearls Publishing*. <https://www.ncbi.nlm.nih.gov/books/NBK540962/>

Strait, E. (2006). *Prosthetics in Developing Countries*. ResearchGate; unknown. https://www.researchgate.net/publication/238088826_Prosthetics_in_Developing_Countries

Tirerack. (2021). Wheel Lug Torquing. [https://www.tirerack.com/tires/tiretech/techpage.jsp?techid=107&fbclid=IwAR1bFk5NKSWeVU7s3233G_KFhNiA3IXoacb7WxKvDiN_BdqG-cAskT_Cnko](https://www.tirerack.com/tires/tiretech/techpage.jsp?techid=107&fbclid=IwAR1bFk5NKSWeVU7s3233G_KFhNiA3IXoacb7WxKvDiN_BdqG-cAskT_Cnkohttps://www.tirerack.com/tires/tiretech/techpage.jsp?techid=107&fbclid=IwAR1bFk5NKSWeVU7s3233G_KFhNiA3IXoacb7WxKvDiN_BdqG-cAskT_Cnko)

Vigotsky, A. D., Halperin, I., Lehman, G. J., Trajano, G. S., & Vieira, T. M. (2018). Interpreting Signal Amplitudes in Surface Electromyography Studies in Sport and Rehabilitation Sciences. *Frontiers in Physiology*, 8. <https://doi.org/10.3389/fphys.2017.00985>



Prosthetic Arm for Amputees: Labor Job in Manufacturing Factories

Robyn Graesha O. Aguda, Andee Beyonce M. Co,
and Camille Elizabeth C. Reyes
De La Salle University Integrated School, Manila

Abstract: Unemployment occurs when an individual with a specified age range does not engage in work and is unpaid; furthermore, they are still looking for new job opportunities. Each person should be allowed to work and earn for their betterment, most significantly, people with physical disabilities. Most amputees utilize prostheses to resume daily tasks and adapt to a sudden lifestyle change to achieve this. This study aims to conceptualize and create a body-powered transradial prosthesis designed to execute both functions of picking and placing actions, particularly for inspection in manufacturing labor, to aid the pressure of restoring a once normal lifestyle. Upon testing the said prosthesis, it had a weight capacity of at least 20 grams with a mechanical gripper's aid to avoid slippage of the bottle. The general testing methods included 90 attempts in proving the prosthesis' functionality and weighing capacity. To conclude, it had 87% and 80% successes in terms of the primary function in both stationary and mobile trials, respectively; further, the prosthesis succeeded in carrying bottles of varying weight with an overall rate of 87%.

Key Words: prosthesis; body-powered; transradial amputee; Bowden cable; mechanical gripper

1. INTRODUCTION

According to research conducted by Mina (2013), the majority of the persons with disabilities (PWDs) in both rural and urban areas are under vulnerable employment, with only 57.1% of the total population employed. Further, several PWDs in paid employment are victims of temporary employment. With this, the government decided to establish the Republic Act No. 7277 or the Magna Carta for Disabled Persons, which took effect in 1992. This act ensures equal opportunities for suitable employment to PWDs as their able-bodied counterparts (Mina, 2013).

An amputee is considered to have a permanent total disability in the upper extremities if two limbs are lost. The loss of a finger, hand, or arm is stated to be a permanent partial disability, automatically making amputees' PWD', which affects their employment status (Labor Code of the Philippines, 2013).

Body-powered (BP) prostheses are lightweight devices controlled by cables operated by body parts. Hook BP prostheses have two types of terminal devices: Voluntary Opening (VO), which opens with no tension from the cable, and Voluntary Closing (VC), which closed due to pressure (Berning et al., 2014). Phantom limb pain (PLP), a side effect often experienced soon after surgery, is often aided by prosthesis therapy. Guo et al. (2016) reported that many experienced the disappearance of the PLP with a prosthesis; perceptions of the missing limb have

distracted the amputee from experiencing pain. The study has also concluded that amputees have better sensory feedback (i.e., visual processing of pictures) in the dominant hand compared to the remaining undisrupted limb. Hence, BP prostheses are also helpful for amputees who lost their dominant hand. Lastly, as the prosthesis's primary function in this study is to pick and place down bottles, a BP prosthesis is better suited; they are produced at lower costs, more durable, and require less training, hence more commercially available (Carey et al., 2015).

1.1 Objectives

Transradial arm prostheses are specifically designed to replace one of the two bones that make up the forearm, running from the wrist to the elbow. This study's objectives include creating a BP transradial prosthetic arm, which opens employment opportunities in factories, specifically in the quality control department. Its primary function is to pick and place a bottle with at least 20 grams of weight without damage.

1.2. Scope and Limitations

This study focuses on making a BP prosthesis similar to Smit and Plettenburg's (2010) version, which utilizes a Bowden cable. Further, the prosthesis has a VO spring gripper with the motion of compliant grasping triggered by a cable based on the concept of Lu et al. (2019). Part of this study's objectives is to create a prosthetic arm executing with repeated

action, which sets the boundary from previous models. Further, the plastic bottle utilized for testing has the following dimensions: 20 cm height, 18.4 cm body circumference, and 10 cm neck circumference.

2. METHODOLOGY

2.1 Prosthesis Design

The first sketch of the prototype utilized a solenoid actuator and a battery pack attached to the socket with a mechanical gripper taken from a toy gripper. There was also no arm area in the prototype sketch. This idea was then scratched when the goal changed to having a mechanical BP prosthesis. The final prototype sketch was used as the basis for the final prototype. PVC pipes assembled at around a 45-degree angle to serve as the arm. The gripper was also changed to a claw mechanism to have its function specific to carrying a bottle. A harness and cable mechanism were also added to support the BP mechanism of the prosthesis.

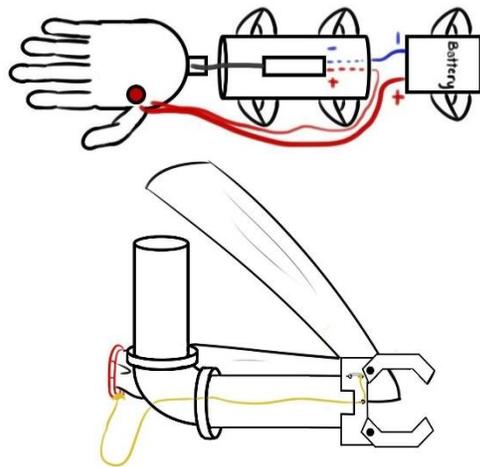

Figure 1-2. First and Final Prototype Sketch

Figure 2 showcases the prosthesis with a forearm of 45.7cm and upper arm of 23.6 cm. The prototype was initially made out of cardboard that used yarn as a cable. Measurements were adjusted before reaching the correct measurements that allowed a good grip on the bottle and were fitted to the amount of hard plastic available. The claw's final measurements were then laid out on a cutting board to be cut into the final prosthesis's gripper parts.



Figure 3-4. Cardboard Prototype of Claw Gripper and Final Prototype with Claw Gripper and Arm

The final prosthesis consists of a plastic gripper attached to the amputee's stump with a frame and a makeshift socket made of PVC pipes, as presented in Figure 5. The socket is also connected to the prosthesis's arm and a simple sash harness made of old bag straps with an adjustable buckle for the user to control their arm movement.

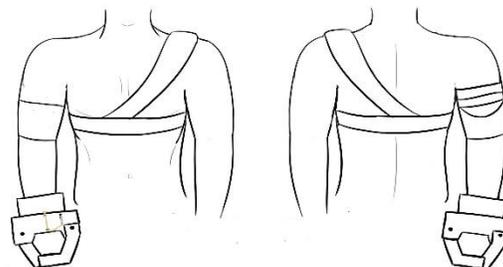

Figure 5. Front and Back View of the Prosthesis When Worn

The cable is attached to the harness's side and to the prosthesis itself, mainly to the gripper's center to pull both claws outward when the cable is stretched. Most Bowden cable prostheses have the cable placed on the arm socket's side or the harness's back. The gripper would open when the user stretches his arm and close when the arm is relaxed (Huinink et al., 2016).

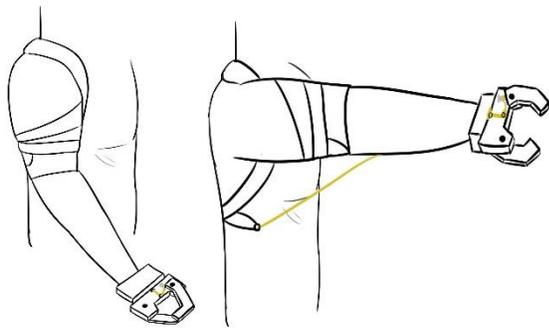

Figure 6-7. Relaxed and Stretched Position (Side View)

The standard position would have the claw closed, and the cable would pull both claw fingers, giving a broader grip that would allow the user to have a better grasp on the bottle. Figures 6-7 showcase the mentioned motion; using a Bowden cable would also reduce frequent cable tears or damage on the prosthesis (Schweitzer, 2017). Also, the prototype has a max angle of approximately 90 degrees.

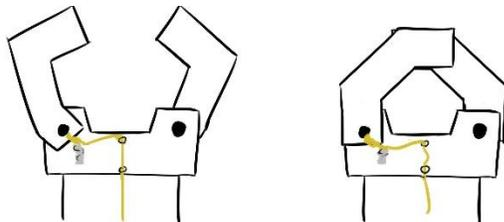

Figure 8. Gripper Design

Lu et al. (2019) utilized a shape memory alloy (SMA) actuator with a spring to control the opening and closing of a gripper. The spring used in their actuator was stretched when the gripper is opened to store elastic potential energy; with said energy, the gripper is closed as the spring locks the joints and itself back into its original position.

This concept is applied in the prosthesis' gripper design, wherein springs are attached to the same screw rings in the claw joints where the cable passes through, as presented in Figure 8. The cable passes through these screw rings and leads into the arm of the prosthesis. Each claw finger's hinge joints are screwed into the hand portion then the gripper would be attached to the prosthesis's arm. The prosthesis always remains at a curved position. The measurements are roughly 27cm for the forearm and 15cm for the upper portion of the prosthesis and socket.

2.2 Testing

The prosthesis underwent trials to test its effectiveness and if it achieves the research's objectives. Testing encompasses three stages: the first stage covered the primary function of the prosthesis;

the second involved an added distance to test its ability to carry the bottle; and the last included a slip resistance test, wherein it measures the prosthesis' capacity to carry a bottle with a weight of at least 20 grams.

The first part examined the lifting and placing ability of the prosthesis; this stage was accomplished in a stationary position and had 30 trials. While the second part involved transferring bottles from different surfaces. It tested whether the prosthesis could carry the bottle to other surfaces with a distance of one meter.



Figure 9. Experimental Setup for Lifting a Bottle

The last stage tested the prosthesis' capability to hold and sustain a bottle of at least 20 grams (minimum weight) without causing deformation. After each trial, there was an addition of 20 grams to the bottle's previous weight until it reached 200 grams. There were three trial sets for this stage, wherein each set had ten trials from the weights 20 grams to 200 grams. There was a total of 30 trials at this stage. Overall, the experimental process involved 90 trials.

2.3 Data Analysis

The first stage of testing focuses on the prosthesis' primary function: the claw's open and close movements and the ability to pick and place objects. The second part showcases the prosthesis' functionality in a factory setting. Lastly, the third stage focuses on its capacity to hold and carry a bottle with a weight of at least 20 grams until a maximum of 200 grams. According to Cooper (2019), different phases for medical equipment would equal different costs and stability of the prototype and its use.



Table 1. Prototype Development Phases (Cooper, 2019)

Phase	Qty	Cost	Time	Stability	What	Use
Appearance Model	1	\$	t	N/A	Rendered images, mock-ups	Business plan show & tell. Fundraising. Evaluation of size, color & features
Proof of Concept	1	\$\$	t	40-80%	Quick assembly of device or key parts. May not look like product	Demonstrate feasibility. Investigate risks. Select components. Investor presentation
Alpha	1-5	\$\$\$\$\$	tttt	70-90% bugs crashes	Looks-like works-like product	Test and evaluate design to find flaws. Review appearance. Limited user testing.
Beta	1-5	\$\$\$\$	ttt	90-98% almost a product	Refined Alpha prototype ready for V&V and production	Iterate & refine to make sure it meets PRS User testing. V&V testing. Clinical Trials
Pilot Production	30-100	\$\$\$	ttt	95-98% Some tooling, pcb, molding, assembly issues	Initial units assembled via production material & processes	Design transfer to production with proper QMS. Soft launch. V&V Testing. Clinical Trials
Matured Product	10k to 1M	\$\$	t	99.99%	Final product	Incorporate modifications from pilot production and clinicals. Full QMS and market release

The research focused on reaching the proof-of-concept standards since there was no actual user testing. This standard means the stability of the prosthesis should reach 40% to 80%. For a more specific standard, the research would use 80% as a benchmark on each test. Since each test would have 30 trials each, the prosthesis would need to function at least 24 out of 30 times to consider it functional and effective. Overall, the prosthesis would need to perform 72 out of 90 trials to determine its general state as a prototype.

3. RESULTS AND DISCUSSION

This study used various tests to create a voluntary opening transradial prosthesis, examine the claw's effectiveness, assess its basic functionality, and check the prosthesis weighing capacity.

The first and second stage tests the prosthesis's functionality: picking and placing a bottle; 30 trials were conducted for each stage shown in Figure 10. The first part performed the primary functions in a stationary position to see if the prosthesis can achieve the first research objective. Out

of 30 trials, the prosthesis was able to sequentially perform 26 out of 30 times or 87% of the whole time. As the prosthesis is considered a prototype, it falls under the Proof of Concept section in Cooper's Prototype Development Phases (2019.) The set functional percentage of the prosthesis is 40% to 80%, which implies it can be considered functional in the first part considering its successes.



Figure 10. Bottle Lifted by Prosthesis

The second part's trials are similar to the first, with only the addition of a measured distance of one meter to mimic quality control workers' movement in a factory setting. In all of the trials, the prosthesis sequentially acted 24 out of 30 times or 80%. With the basis of the Prototype Development Phases Table (2019), the prosthesis has exceeded the limit of 80%.

Table 2. Lifting and Placing of Prosthesis (Stationary and Mobile)

TRIAL	Lifting & Placing (Stationary)	Lifting & Placing (Mobile)
1	passed	passed
2	passed	failed
3	passed	passed
4	failed	passed
5	passed	passed
6	passed	passed
7	passed	passed
8	failed	passed
9	failed	passed
10	passed	passed
11	passed	passed
12	passed	failed
13	passed	passed
14	passed	failed
15	failed	passed
16	passed	passed
17	passed	passed
18	passed	passed
19	passed	passed
20	passed	passed
21	passed	passed
22	passed	failed
23	passed	passed
24	passed	passed
25	passed	failed
26	passed	failed
27	passed	passed
28	passed	passed
29	passed	passed
30	passed	passed



The third stage tests the prosthesis in carrying an object with a weight of at least 20 grams to 200 grams. Water was added to a plastic bottle to get the corresponding weight. In total, three sets with ten trials each were conducted to see the prosthesis's weighing capacity. Each set includes ten trials. In Table 3, the weights with asterisks imply the prosthesis started having difficulty carrying the bottle.

The first set of results showed that the prosthesis could pick up the bottle in all trials. In the second set, the prototype was able to carry eight out of ten times. In the weights 140 grams and 200 grams, it dropped the bottle during the process. In the last set, the prosthesis was also able to carry the bottle eight out of ten times. It had difficulty in maintaining the bottle with the weights of 180 grams and 200 grams. Overall, the prosthesis was able to function 26 out of 30 times (87% success rate).

Table 3. Weight Effectiveness of Prosthesis

W	20 g	40 g	60 g	80 g	100 g
T1	passed	passed	passed	passed	passed
T2	passed	passed	passed	passed	passed
T3	passed	passed	passed	passed	passed

W	120 g	140 g	160 g	180 g	200 g
T1	passed	passed*	passed*	passed*	passed*
T2	passed	passed*	failed	passed*	failed
T3	passed	passed*	passed*	failed	failed

The prosthesis has fulfilled 76 trials out of 90 attempts in the whole experimental process. As the minimum requirement for it to pass as a proof of concept is 80%, the prosthesis was considered functional and effective.

4. CONCLUSION AND RECOMMENDATION

This study used various experimental tests to perform the basic functionality and show the BP prosthesis's effectiveness. It successfully functions 87% and 80% in picking and placing motions at stationary and mobile positions, respectively. As per its weighing capacity, the prosthesis was able to carry bottles in all trials for the first set; in the second set, however, it dropped the bottles with weights 160 and 200 grams. Consequently, it failed at 180 at 200 grams in the final set. Overall, it was able to pick up bottles

26 out of 30 times or at 87%. It was observed that the prosthesis had difficulty in carrying weights starting from 140 grams in all sets. All stages reached the requirement of 80% to be considered functional.

The prosthesis is functional, and the mechanical gripper with its equipped actuator has a specified degree of freedom not far from the bottles' dimensions. It is recommended that modular claw attachments with more DOF are made to execute other tasks concerning the amputee's field of work. Using an electromyogram sensor and motors to activate the prosthesis may also help reduce the user's effort upon working since the amputee uses their whole arm to execute the prosthesis's opening and closing action. It is also recommended to utilize the dominant hand for efficiency as this decreases potential PLP. Although the prosthesis's overall cost would significantly increase, a variation with the prosthesis design, most specifically with its modular adjustments, would target a larger market of possible buyers.

5. ACKNOWLEDGEMENTS

First and foremost, we would like to express our gratitude to our research supervisor, Mr. Michael Manguerra, for extending his wise knowledge to us and guiding this study with his utmost care despite his other endeavors as a university professor. He was able to instruct us with the proper way of constructing a paper, as well as pointers, to avoid writing erroneous statements that oppose the original intent of the paper. His guidance and supervision are undoubtedly appreciated. Further, we also wish to extend our heartfelt thanks to our parents, who had provided us with the materials required for this study; likewise, we are grateful for the love, patience, and support they had shown to finish the paper ultimately. Lastly, we sincerely cherish God for all His graceful blessings; all was possible because of Him.

6. REFERENCES

Berning, K., Cohick, S., Johnson, R., Miller, L. A., & Sensinger, J. W. (2014). Comparison of body-powered voluntary opening and voluntary closing prehensor for activities of daily life. *Journal of Rehabilitation Research and Development*, 51(2), 253–262. doi:10.1682/jrrd.2013.05.0123

Carey, S., Lura, D., Highsmith, J. (2015). Differences in myoelectric and body-powered upper-limb prostheses: Systematic literature review. *Volume 52*. Pages 247–262

Cooper, T. (2019). Understanding Prototype Development Phases For Medical Products. Retrieved from: <https://www.meddeviceonline.com/doc/understanding-prototype-development-phases-for-medical-products-0001>



- Guo, X., Lin, Z., Lyu, Y., Bekrater-Bodmann, R., Flor, H., & Tong, S. (2017). The Effect of Prosthesis Use on Hand Mental Rotation After Unilateral Upper-Limb Amputation. *IEEE Transactions on Neural Systems and Rehabilitation Engineering*, 25(11), 2046–2053. doi:10.1109/tnsre.2017.2702117
- Huinink, L. H., Bouwsema, H., Plettenburg, D. H., van der Sluis, C. K., & Bongers, R. M. (2016). Learning to use a body-powered prosthesis: changes in functionality and kinematics. *Journal of neuroengineering and rehabilitation*, 13(1), 90.
- Labor Code of the Philippines (2013). *Handbook of Employee's Compensation and State Insurance Fund*. Book IV, Title II of P.D. No. 441
- Lu, Y., Xie, Z., Wang, J., Yue, H., Wu, M., & Liu, Y. (2019) A novel design of a parallel gripper actuated by a large-stroke shape memory alloy actuator. *International Journal of Mechanical Sciences*. 159. 10.1016/j.ijmecsci.2019.05.041.
- Mina, C. (2013). *Employment of Persons with Disabilities (PWDs) in the Philippines: The Case of Metro Manila and Rosario, Batangas*, PIDS Discussion Paper Series, No. 2013-13
- Schweitzer, W. (2017). Technical Below the Amputee Issues- Bowden cable mount for prosthetic arm [patent, explained]. Retrieved from <https://www.swisswuff.ch/tech/?p=7172>
- Smit, G., & Plettenburg, D. H. (2010). Efficiency of voluntary closing hand and hook prostheses. *Prosthetics and orthotics international*, 34(4), 411–427. Retrieved from <https://journals.sagepub.com/doi/pdf/10.3109/03093646.2010.486390>



Comparative Analysis between the Shinyei PPD42NS and Plantower PMS7003 Low-Cost Air Quality Sensors

Camron Evan C. Ong, Kerby Matthew C. Chiu, Keziah Bryanna T. Lat,
and Mary Alaena Katelyn P. Magnaye
De La Salle University Integrated School, Manila

Hiroki Asaba and Clement Y. Ong
De La Salle University, Manila

Abstract: Particulate matter (PM) is a form of air pollution that is considered harmful as these may cause respiratory problems. PM sensors are used to measure PM in the air and vary in costs. There have been many studies done on the accuracies of these sensors based on their price. In this research, a comparative analysis was done between a low-cost sensor, the Shinyei PPD42NS, and a mid-range sensor, the Plantower PMS7003. In previous studies, there were comparisons made between low quality sensors but no direct comparison between these two sensors. The tests were done in an indoor and outdoor environment wherein sensors were placed beside each other to measure particulate matter greater than 1 micron for a continuous span of 10 hours. Results from these tests showed that the Shinyei measurements broadly follow the more expensive Plantower but have more significant deviations over short periods. Larger deviations were noted in the morning and evening periods of testing. Recommendations for further characterization are provided in this paper.

Key Words: Particulate Matter; Air Quality Monitoring; Low-cost PM sensor; Shinyei PPD42NS; Plantower PMS7003

1. INTRODUCTION

Pollution is a problem faced throughout the world and can spread to other parts of the world (National Geographic Society, 2012). Air Pollution can not only bring harm to the environment but also to the health of the population. It is the ninth leading risk factor for death, and it is responsible for 3.2 million deaths each year (Kurt et al., 2016). The statistics from the World Health Organization (WHO) in 2016 shows that 91% of the population of the world reside in places that do not meet the imposed air quality standards, and estimates that in the same year, approximately 4.2 million deaths worldwide were caused by outdoor air pollution (Ambag, 2018).

Particulate matter (PM) is a form of air pollution involving solid materials and liquid droplets. The particles may come from both natural events and man-made sources. These particles range in size and are categorized into two main groups, which are PM 10 and PM 2.5. PM 10 involves particles sized 10 micrometers and smaller, while PM 2.5 involves 2.5 micrometers and smaller. Exposure to these can pose different threats to human health and the environment both short term and long term (EPA, 2018).

Detectors are used by the government to know the quality of air. The Beta Attenuation Monitor

(BAM) is most widely used by governments and is considered the standard for detecting particulate matter in the air but is expensive to produce. While low-cost sensors are existent, they are still being developed and are still faulty and inconsistent (European Commission, n.d.). When compared to the standard particulate matter sensors, these cheap sensors are shown to be less accurate (Ahn et al., 2019). Furthermore, these sensors require specific technological components which may not be available in other places of the world.

The urgency to design and manufacture low-cost air quality sensors is widespread. Low-cost air pollution sensors enable high-quality resolutions in real-time and provide new opportunities to enhance existing sensors, as well as engage with the public in active monitoring (Castell et al., 2016). However, the quality of the data gathered is questionable. Studies have reported that low-cost sensors are unstable and often affected by atmospheric conditions (Karagulian et al., 2019).

This study aims to compare the performance between the Shinyei PPD4NS sensor and Plantower PMS7003 sensor in terms of accuracy in measuring particulate matter. Additionally, the capabilities and limitations of the Shinyei will be identified. The tests will be conducted in both an

indoor and outdoor environment, and particulate matter will be measured in concentration.

2. PM SENSORS

2.1 Shinyei PPD42NS

The Shinyei PPD42NS uses the light-scattering principle (Tan, 2013). Particulate matter present in the air is measured based on the light scattered by the particles. A heating element is present that causes air to flow in, rise through, and out of the sensor. Additionally, some guidelines are provided when using the sensor, namely that it should be vertically oriented, in a dark area, and be given time to warm up. The sensor outputs a logic low whose time is proportional to the particulate matter concentration. Results from the sensors showed that one had occasional sporadic output compared to the other (Tan, 2013).

Additionally, according to Canu et al. (2018), the Shinyei sensor gives two outputs, P1 outputs information about particles over 1 μm while P2 outputs about particles over 2.5 μm , meaning that it cannot measure certain PM sizes strictly. The sums of the duration of low outputs from P1 or P2 is proportional to the quantity of dust particles. The correlation for P1 is shown in Figure 1.

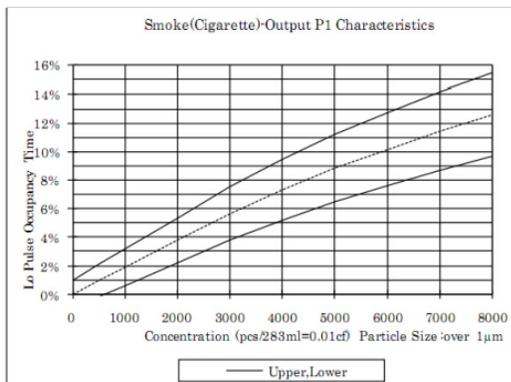

Figure 1. Relation between P1 LPO and PM concentration (Canu et al., 2018)

2.2 Plantower PMS7003

The Plantower PMS7003 uses laser scattering to measure particulate matter. The amount of light scattered due to particles are collected. The equivalent particle diameter and the number of particles with different diameter per unit is calculated by a built-in microprocessor. These measurements are provided in both $\mu\text{g}/\text{m}^3$ and in pieces per 0.1L. The Plantower is known to be effective and reliable in measuring PM (Badura et al., 2018).

3. METHODOLOGY

3.1 Data Collection Setup

Two independent systems to measure the quality of the air were developed. One is based on the Shinyei PPD42NS sensor, and the other based on the Plantower PMS7003 sensor. The Shinyei PPD42NS sensor was programmed with a code provided by SeeedStudio (2015), while the Plantower PMS7003 sensor was programmed with a code provided by Alam (2019). The sensors were set up to measure particulate matter sized greater than 1 μm and tested simultaneously in two different environments around a residence. The indoor test was conducted in a 52 m^3 room with three opened doors and only natural air flow circulating air, while the outdoor testing was done in an open-faced roofed garage.

3.2 Data Collection Method

Both sensors were set-up, connected, then interfaced through an Arduino board. As shown below in Figure 2, the Shinyei sensor was placed vertically for air to flow into the lower hole and out the upper. Additionally, data was not recorded for the first three minutes of connecting the Shinyei to allow it to first heat up its heating element which allows the flow of air in and out.

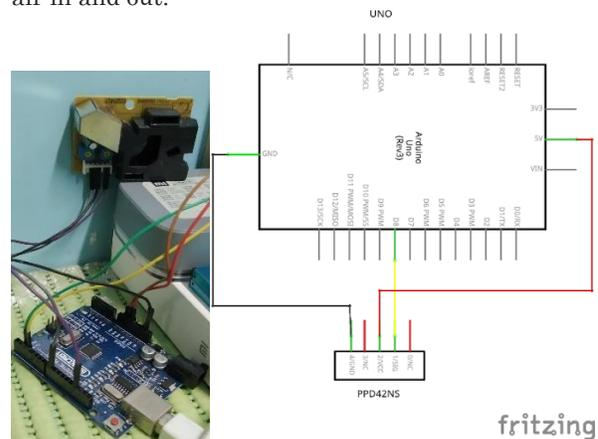

Figure 2. The setup of the Shinyei PPD42NS connected to an Arduino Board (Goram, 2019).

The Plantower was placed near the Shinyei to also obtain readings. Both sensors were interfaced through individual Arduino boards as shown below in Figure 3.

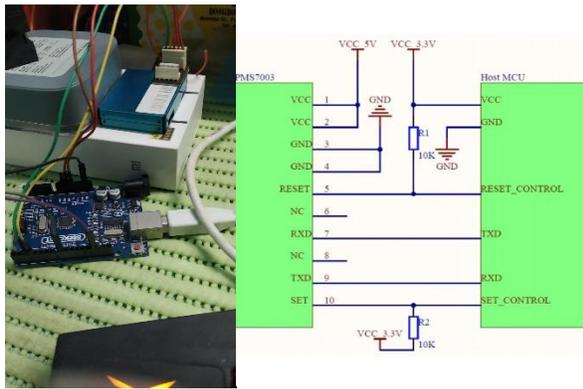

Figure 3. The Plantower PMS7003, connected to the same Arduino board (Zhou, 2016).

Data from the sensors were interfaced through the Arduino board, then transferred to Microsoft Excel to graph the readings.

3.3 Data Analysis Strategy

A conversion in the gathered data was necessary to visualize the readings of the sensors. The Shinyei PPD42NS measures in pieces per 0.01 cubic feet, while the Plantower PMS7003 measures in micrograms per liter of air. Additionally, the sensors send data at different time intervals, specifically, the Shinyei is set to send data in 30-second intervals, while the Plantower is set to 1-second intervals. After converting the data, the PM measurements were smoothed, graphed, and represented through line graphs showing the changes of the PM concentrations on the y-axis with the corresponding time on the x-axis. These graphs were used to compare and analyze the sets of data visually and statistically.

4. RESULTS

As shown below, Figure 4 shows the measurements taken from the two sensors in an indoor environment. The data collected from the Shinyei and the Plantower were done in a 10-hour test.

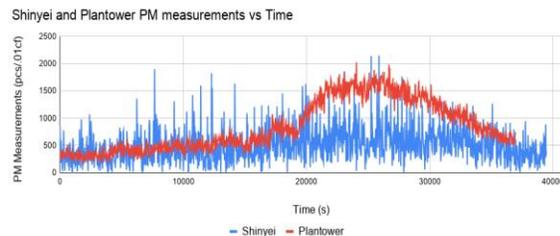

Figure 4. Original Indoor Measurements

The original data gathered is shown, represented by blue for the Shinyei, and red for the Plantower. These measurements are noisy is difficult

to be accurately analyzed, hence a smoothing function, specifically through moving average, was done. Shown below in Figure 5 are the smoothed graphs.

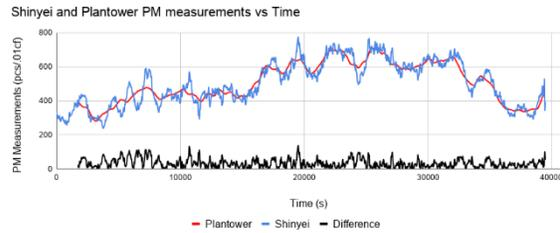

Figure 5: Smoothened Indoor Measurements

The blue line represents the Shinyei's measurements, while the red line represents the Plantower's. Both sets of data were smoothed through continuously averaging 25 data points for the Shinyei, and 15 data points for the Plantower. After time-aligning the data to match the graph, the difference between the two sensors' measurements was found, graphed and represented by the black line. It can be seen in the blue line that the Shinyei follows the trend of the Plantower's measurements throughout the test period, with a root-mean-square-error (RMSE) of 41 pcs/0.01cf.

Figure 6 below shows the PM readings from the sensors in the outdoor environment. These tests were done simultaneously while each sensor was beside each other for a period of 10 hours, starting mid-morning to early evening.

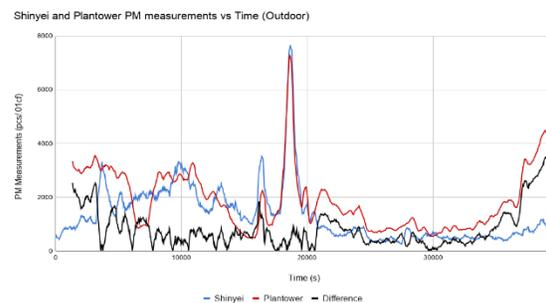

Figure 6: Smoothened Outdoor Measurements

Like the indoor graph, the blue line represents the Shinyei, and the red represents the Plantower. For this set, 15 data points were continuously averaged to attain a smoothed graph. The data was time aligned as well to attain an accurate difference measurement. The graph shows that the Shinyei had lower readings in both the earlier part of the day as well as towards the night compared to the Plantower. The middle parts of the data are similar, however. The large peaks in the middle are nearly identical, with the Shinyei having a slightly



higher reading, peaking at 7367 pcs/0.01cf whilst the Plantower peaked at 7257 pcs/0.01cf. The RMSE is 1087 pcs/0.01cf which is attributed both the differences in the morning and evening, as well as the similarities in the afternoon.

5. DISCUSSIONS

Based on the findings, the two sensors are able to produce readings which show that they can be related. This means that the Shinyei PPD42NS can match the performance of the Plantower PMS7003, but only up to a certain degree. Looking back at the time-series graphs of the indoor test, the difference of each point of data is, again, relatively small. This is a good sign as the studies of Kuula et al. (2019) found that the sensor was effective and usable as a complementary to other particulate matter sensors. However, it should be noted that even after smoothening the data, the Shinyei was still noisy in its measurements.

On the other hand, as stated previously, the Shinyei's PM measurements in the morning and evening were significantly lower compared to what the Plantower recorded. The discrepancies during these periods may indicate that temperature and relative humidity might have skewed the sensor's measurements. Jayaratne et al. (2018) and Rai et al. (2017), also believe that temperature and humidity is factor that contributes to the inconsistencies of the Shinyei sensor. Although these factors may also affect the performance of the PMS7003, it can be implied that since the Shinyei is the significantly lower costing sensor, it also has lesser tolerance to environmental influence. To add, this may have not been observed in the indoor test since walls and a roof provide significant degrees of insulation from external environmental changes.

On the other hand, Holstius et al. (2014) investigated another factor, ambient light, which could also be a factor toward the Shinyei's measurements in the morning and night. Additionally, as it was an outdoor experiment, wind may have also factored in. Since the Shinyei relies on a heating element, it relies on air density differences for its airflow. This is more easily affected by wind compared to other sensors in general, which make use of fans for consistent airflow.

That being said, the Shinyei performed well in the afternoon parts of the outdoor test wherein it followed the Plantower's graphs better than in the morning and evening. Additionally, the larger difference in the RMSE values of the outdoor test compared to the indoor is also attributed to higher PM levels outdoors than indoors.

6. CONCLUSION

The Shinyei PPD42NS is a capable low-cost air-quality sensor in terms of particulate matter measurement performance when compared with the Plantower PMS7003. The indoor test showed very promising results in accurately measuring particulate matter, whilst the outdoor test was overall decent as well despite external factors potentially affecting the Shinyei. The lower cost and bare construction allow room for modifications thus providing significant potential. Future research will investigate exposing the Shinyei to controlled PM sizes and testing its performance in more environments with controlled light levels, temperature, and relative humidity. In line with this, the study will continue to improve the Shinyei by identifying limitations and adding corrective modifications, such as fans and filters, to improve its usability and performance in measuring particulate matter.

7. REFERENCES

- Ahn, K. H., Lee, H., Lee, H. D., & Kim, S. C. (2019). Extensive evaluation and classification of low-cost dust sensors in laboratory using a newly developed test method. *Indoor Air*, 30(1), 137–146. <https://doi.org/10.1111/ina.12615>
- Alam. (2019, October 14). *Interfacing PMS5003 PM2.5 Air Quality Sensor with Arduino*. Retrieved from <https://how2electronics.com/interfacing-pms5003-air-quality-sensor-arduino/>
- Ambag, R. (2018, June 18). *How bad is air pollution in the Philippines?* Retrieved from <https://www.flipscience.ph/health/how-bad-air-pollution-philippines/>
- Badura, M., Batog, P., Drzeniecka-Osiadacz, A., & Modzel, P. (2018). Optical particulate matter sensors in PM_{2.5} measurement in atmospheric air. *E3S Web Conference*, 30, 1-8. <https://doi.org/10.1051/e3conf/20184>
- Canu, M., Galvis, B., Morales, R., Ramirez, O., & Madelin, M. (2018). Understanding the Shinyei PPD42NS low-cost dust sensor. *2018 IEEE International Conference on Environmental Engineering (EE)*. https://www.researchgate.net/publication/324171671_Understanding_the_Shinyei_PPD42NS_low-cost_dust_sensor
- Castell, N., Dauge, F., Schneider, P., Vogt, M., Lerner, U., Fishbain, B., Broday, D., & Bartonove, A. (2016, December 28). Can commercial low-cost sensor platforms contribute to air quality monitoring and exposure estimates? *Environment International*, 99, 293-302. <https://doi.org/10.1016/j.envint.2016.12.007>
- EPA. (2018, November 14). *Particulate Matter (PM) Basics*. Retrieved from <https://www.epa.gov/pm-pollution/particulate-matter-pm-basics>
- European Commission. (n.d.). *Measuring air pollution with low-cost sensors: Thoughts on the quality of data measured by sensors*. Retrieved from <https://ec.europa.eu/environment/air/pdf/Brochure%20low-cost%20sensors.pdf>
- Goram, M. (2019, March 31). *What Is the Air Like?* Retrieved from <https://www.hackster.io/baqwas/what-is-the-air-like-a47d8a>



- Holstius, D. M., Pillarisetti, A., Smith, K. R., & Seto, E. (2014, January 27). Field calibrations of a low-cost aerosol sensor at a regulatory monitoring site in California. *Atmospheric Measurement Techniques Discussions*, 7, 605-632. <https://doi.org/10.5194/amt-7-1121-2014>
- Jayarathne, R., Liu, X., Phong, T., Dunbabin, M., & Morawska, L. (2018). The influence of humidity on the performance of a low-cost air particle mass sensor and the effect of atmospheric fog. *Atmospheric Measurement Techniques*, 11, 4883-4890. <https://doi.org/10.5194/amt-11-4883-2018>
- Karagulian F., Barbieri, M., Kotsev, A., Spinelle, L., Gerboles, M., Lagler, F., Redon, N., Crunaire, S., & Borowiak, A. (2019, October 3). Review of performance of Low-cost Sensors for Air Quality Monitoring. *Atmosphere*, 10(9), 506. <https://doi.org/10.3390/atmos10090506>
- Kuula, J., Kuuluvainen, H., Ronkko, T., Niemi, J. K., Saukko, E., Portin, H., ... Timonen, H. (2019). Applicability of Optical and Diffusion Charging-Based Particulate Matter Sensors to Urban Air Quality Measurements. *Aerosol and Air Quality Research*, 19, 1024-1039. doi: 10.4209/aaqr.2018.04.0143
- National Geographic Society. (2012, October 9). *Pollution*. Retrieved from <https://www.nationalgeographic.org/encyclopedia/pollution/>
- Rai, A. C., Kumar, P., Pilla, F., Skouloudis, A. N., Sabatino, S. D., Ratti, C., Yasar, A., & Rickerby, D. (2017, June 29). End-user perspective of low-cost sensors for outdoor air pollution monitoring. *Science of the Total Environment*, 607-608, 691-705. <https://doi.org/10.1016/j.scitotenv.2017.06.266>
- SeeedStudio. (2015, September 23). *Grove-Dust Sensor User Manual*. Retrieved from https://www.mouser.com/datasheet/2/744/Seeed_101020012-1217636.pdf
- Tan D. (2013, July 24). *Testing the Shinyei PPD42NS*. Retrieved from <http://irq5.io/2013/07/24/testing-the-shinyei-ppd42ns/>
- Zhou, Y. (2016). Digital universal particle concentration sensor (2.5). [Datasheet]. Retrieved from https://download.kamami.com/p564008-p564008PMS7003%20series%20data%20manua_English_V2.5.pdf



FoFi: The Development of a Handheld Monitoring Device in Predicting Naturally Occurring Forest Fires

Riley Esybel O. Baguinon, Marielle C. Batinga, Joaquin Antonio L. Dayrit
and Mon Nicolai T. Estrella

De La Salle University Integrated School, Biñan City, Laguna

Abstract: Forest fires, which are natural or artificial burning of woodlands, negatively affect people and the environment. In the Philippines, Cordillera is one of the hotspots for forest fires, with approximately 122 forest fire incidents. Thus, developing a monitoring device for the early prevention of forest fires would reduce these incidents' frequency. This research aimed to create a handheld prototype device, FoFi, that gathers quantitative data which can be used with the Department of Natural Resources's data science and predictive analytics. Using an Arduino Microcontroller and sensors, the device will collect and send data. Two phases were conducted to create a monitoring prototype device for predicting forest fires. According to the results, the temperature and humidity (DHT-22) sensor showed reliable data since it can detect temperature under normal conditions, having a mean of 30.65°C; also, it precisely recorded the relative humidity with a mean of 7.89%. The Global Positioning System (GPS) module obtained a mean error of 7.251 m, which exhibited accuracy in detecting GPS coordinates. Additionally, the Globe SIM showed efficiency for Global Systems for Mobile (GSM) communication since the mean length of time for sending a message is 5.022 s. On the other hand, the gas sensor (MQ-2) and photoresistor lacks sensitivity when used; thus, a more sensitive sensor is recommended. In conclusion, the handheld device was able to achieve its purpose of monitoring forest fires.

Key Words: forest fires; handheld monitoring device; arduino microcontroller

1. INTRODUCTION

A forest fire is the burning of temperate woodland due to natural or human causes (United Nations, n.d.), which can turn uncontrollable due to environmental factors such as wind or topography. The effects of forest fires include the degradation of fauna and flora, increased carbon dioxide levels, and a compromised natural cycle. The increased carbon dioxide levels also contribute to climate change and soil erosion (Perez, 2017). Particulate matter combined with toxic gases such as carbon monoxide (CO) can cause health problems such as heart disease (Stefanidou et al., 2008). The economy has also been negatively affected by forest fires. This is because the costs to recover from these incidents have exponentially risen. In 2015, Indonesia's cost to suppress forest fires amounted to 14 billion dollars (Hirschberger, 2016) and approximately 63 billion dollars for the United States (Thomas et al., 2017).

Furthermore, the Forest Management Bureau (FMB) Chief under Forest Protection stated that the FMB and the DENR imposed a protection system called 'LAWIN,' which uses open-source technology to provide geospatial data analysis obtained from forests. It provides a data model for

identifying forest conditions, including information on practical solutions in response to the data imparted.

Dumlao (2019) reported that from January to March 2019, the Bureau of Fire Prevention in Cordillera reported 90 occurrences of the forest fire that have damaged at least 140,000 hectares of forest in Cordillera alone. Agoot (2019) indicated that Cordillera had approximately 122 forest fire incidents. These incidents implicate Cordillera as a hotspot for forest fires.

In this study, the researchers designed and developed a multi-sensor monitoring device called FoFi (from *forest fires*). It aimed to gather data to aid data science researchers for better prediction of naturally occurring forest fires.

Since studies showed that forest fire incidents had increased annually, immediate prevention is essential. Proper wildfire management is about effective communication of information regarding forest fires and technological advancements aid in optimizing effective forest fire detection systems (Molina-Pico et al., 2016). With this, FoFi, from the word forest fires, will help in monitoring forests. The contribution of LAWIN to forestry is significant; however, it only focuses on managing forests to avoid

deforestation and degradation, whereas FoFi aims to collect data to predict forest fires.

This study's findings will benefit society and the academic community since it tackles how citizens can protect the forest environment and avoid such disasters. Also, government agencies such as DENR and FMB may benefit from this because this can aid in gathering quantitative data about the status of forests. The increase of forest fires in the Philippines means that this should be addressed immediately so that society members can face such calamities better or even prevent.

2. METHODOLOGY

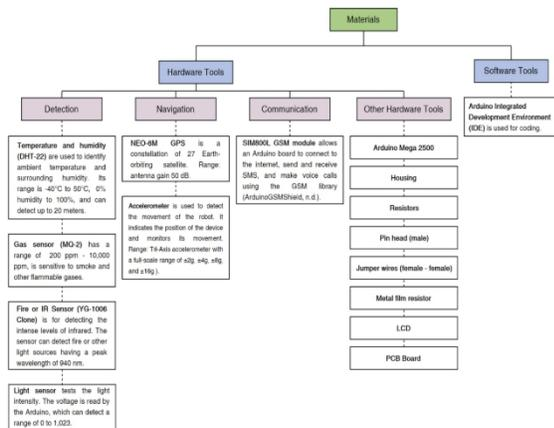

Fig. 1. List of materials needed for the handheld device.

The list of requirements, together with the knowledge gathered about the various devices and sensors, was used to plot out the materials needed for FoFi. Arduino was strictly used for the microcontroller and programming language to create a monitoring system for forest fires. The components used were interfaced together and a GSM module was used as there are cell towers present in the targeted forest areas. Moreover, this research was conducted using a fire and environment simulation and not in an actual forest environment. The intent of this was to test the efficiency of the device in gathering data and not its durability. The sensors were limited to what was listed in Figure 1. Additionally, there were two phases in conducting the study: evaluating the sensors and refining FoFi.

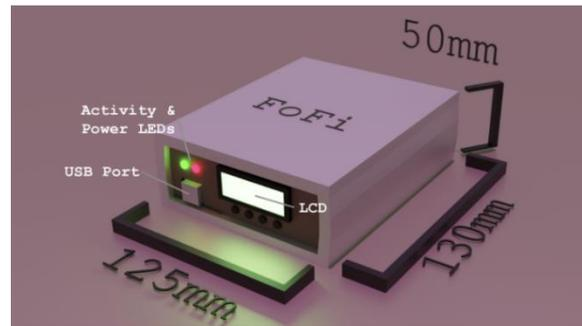

Fig. 2. A 3D draft model of FoFi.

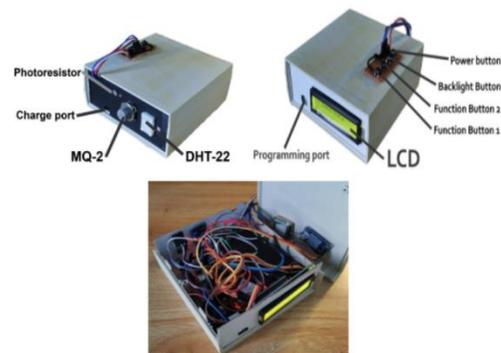

Fig. 3. Final version of FoFi with sensors pieced together.

With a general idea of the housing and hardware, a draft 3D model was made using Blender 2.9. there were some changes in piecing all the components together for the final device. Figure 3 shows the final version of FoFi. Unlike the draft, the buttons were moved on top due to the lack of space caused by the LCD driver board. The rest remain the same with the LCD and USB port being in front while the sensors and charging port are at the back.

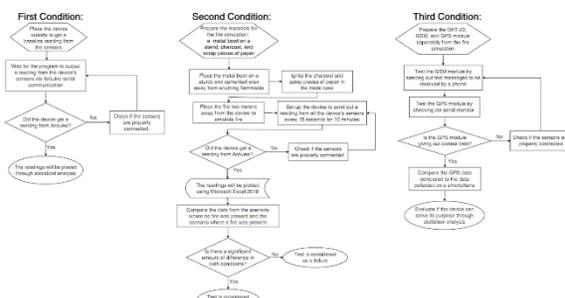

Fig. 4. Evaluation of the handheld device.

According to Figure 4, there were three conditions in evaluating FoFi. In the first condition, the sensors were tested on a normal setting, without fire. The device was then tested in a fire simulation for the second condition. For the third condition, some



sensors were tested separately from the fire simulation. The conditions were evaluated using statistical analysis to gather quantitative data. Also, it involved the estimation of parameters to gauge the mean parameters of the data collected and hypothesis testing, which determined the reliability of the data. A quantitative experimental research design was used to test the ability of each sensor to collect data.

The prototype was refined to ensure that the device can successfully gather data. This involved fixing the device to resolve any issues that were identified during the testing phase. There were four challenges encountered during building FoFi. First, the MQ-2 and IR sensors were not functioning correctly. Both sensors were then retested at different conditions to double-check their functionality. Second, there was a defect in the ability of the GPS module to provide data. However, after re-examining it, the sensor only needs a few minutes to lock onto satellites before providing the data. Also, reprogramming the Arduino enabled detection regarding whether the GPS module is ready. Third, there was an issue with the Arduino Mega's serial communication. After thorough testing, it was determined that the TX and RX pins were interchanged and the GSM module only works on Serial IO 1 and not on other serial ports due to its need for serial interrupts. Lastly, insufficient current was evident while testing; the Arduino and sensors were not able to run through USB power from a laptop; thus, the rechargeable battery was used during the testing.

3. RESULTS AND DISCUSSION

Statistical analyses were interpreted using Microsoft Excel 2019. The estimation of the true mean parameters of primary data is determined at a 5% level of significance. A two-tailed test at a 5% level of significance tested the null hypothesis of whether the mean parameters of primary data are significantly comparable to the mean parameters of data obtained from the data collection stage or other studies.

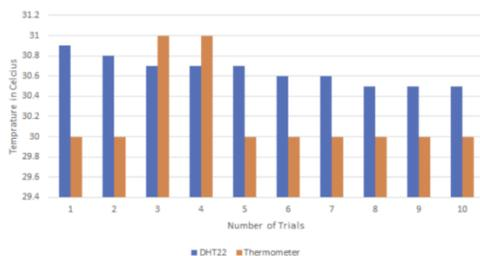

Fig. 5. Temperatures recorded by the DHT-22 sensor and thermometer.

Table 1. Data analysis for ambient temperature recorded using DHT-22 sensor:

Mean (°C)	30.65
Standard Deviation	0.1285
Variance	0.0165
Estimation of Parameters (One Population Mean) ¹ at $\alpha = 5\%$	30.65 ± 0.0796
Hypothesis Testing (One Population Mean) ¹ at $\alpha = 5\%$, t-test	Ho: $\mu = 30.20$; Ha: $\mu > 30.20$ p-value: 1.0000, $t > 1.8331$ or $p > 0.05$, reject Ho.

1 - recorded on 1/18/21 from 4:06 to 4:30 pm; mean temperature noted with thermometer () : 30.20°C

A DHT-22 sensor is used to detect temperature and humidity. Its range is -40°C to 50°C, 0% to 100% humidity, and it can detect up to 20 meters. Given the mean temperature recorded

() by the thermometer, there is proof that the sensor is accurately detecting temperatures in normal conditions. Though Trials 3 and 4 were the only trials wherein the sensor detected lower temperatures than the thermometer, the difference is not significant enough to warrant misinterpretation. However, Obanda (2017) did not compare the sensor readings with a thermometer to test accuracy; the grove temperature sensor used successfully detected temperature changes. Similarly, the DHT-22 was more precise as it had an accuracy of $\pm 0.5^\circ\text{C}$ compared to the grove sensor's which was $\pm 1.5^\circ\text{C}$. Although the grove sensor can read up to 125°C compared to 80°C from the DHT-22, the device is not aimed to detect extreme temperatures.

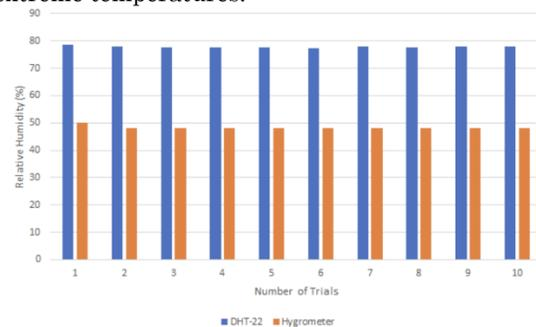

Fig. 6. The data from the DHT-22 sensor when tasked to read the relative humidity.

Table 2. Data analysis for relative humidity using a DHT-22 sensor:

Mean (%)	77.89
Standard Deviation	0.3562
Variance	0.1269
Estimation of Parameters (One Population Mean) ² at $\alpha = 5\%$	77.89 ± 0.2208
Hypothesis Testing (One Population Mean) ² at $\alpha = 5\%$, t-test	Ho: $\mu = 48.20$; Ha: $\mu > 48.20$ p-value: 1.0000, $t > 1.8331$ or $p > 0.05$, reject Ho.

2 - Data recorded on 1/18/21 from 4:06 to 4:30 pm; mean temperature noted with thermometer during this period (°): 48.20%

Given the mean relative humidity recorded (°) by the thermometer, there is proof that the sensor recorded relative humidities but inaccurately. The sensor's mean humidity records are significantly higher than the humidity recorded by the thermometer, which may lead to misinterpretation of data. The sensor's data was precise, indicating that further tests can be conducted to compensate for the unusually high readings with software.

The MQ-2 sensor is sensitive to smoke and has a built-in potentiometer to adjust its sensitivity for digital output (Mukherjee, 2016). Across ten trials, only the first trial showed a value of 2 parts per million (ppm) for CO and 0 ppm for the other trials. In detecting LPG, it reported 0 ppm across all trials as no LPG was present during the testing. This was included in the testing to determine a possibility of a trend in LPG readings. Like the CO tests, the first test showed 2 ppm for a smoke while the rest showed 0 ppm. This is similar to Niranjana and HemaLatha's (2018) findings, as they found that the range of raw data given was 45 to 80 ppm without smoke and 100 to 250 ppm with smoke. Conclusively, the sensor did not detect smoke, LPG, or carbon monoxide levels accurately enough to be used in the device.

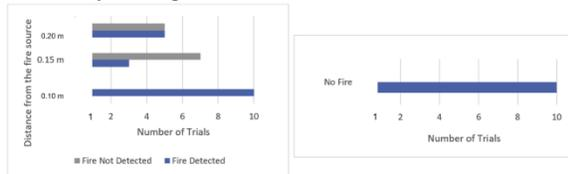

Fig. 7. The YG-1006 sensor's data regarding the detection of infrared levels

The infrared sensor (YG-1006) can detect fire or other light sources having a peak wavelength of 940 nm. According to Figure 7, in the trial without fire, all ten trials reported a fire which are attributed to the presence of sunlight during testing. When placed 0.10 meters away, all ten trials also reported fire. Furthermore, when placed 0.15 meters away, 30% of the trials detected fire, and when placed 0.20 meters away, half of the trials detected fire. This indicates that a YG-1006 sensor would be impractical as it may detect sunlight as infrared. Although Obanda (2017) recommended to use a YG-1006 sensor instead of a light sensor, the results still reported inconsistencies due to the presence of sunlight.

The light sensor (photoresistor) can be used together with a 10k ohm resistor connected to the ground to give various voltage outputs. This is then read by the Arduino's analog input which could provide a range of values from 0 to 1023. The device was subject to three scenarios (10 trials per scenario):

- A scenario with no light

- A scenario where a light source is placed 5cm away
- A scenario with the light source directly on the sensor

The values obtained from this sensor were consistent across all 10 trials for all 3 scenarios; however, due to the sensor only giving various voltages and depending on the analog read pins of the Arduino, the values do not have any standardized unit of measurement such as lux. This is a problem as it could lead to inconsistencies across multiple devices and potentially negatively affect the effectiveness of data science research.

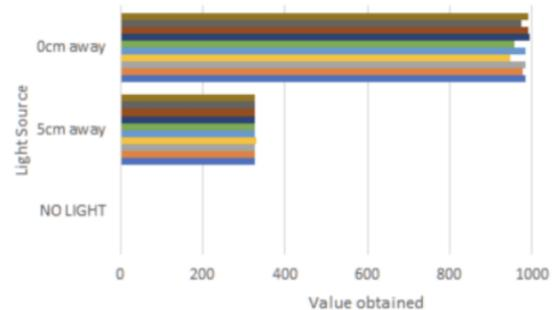

Fig. 8. The photoresistor's data in varying lighting conditions

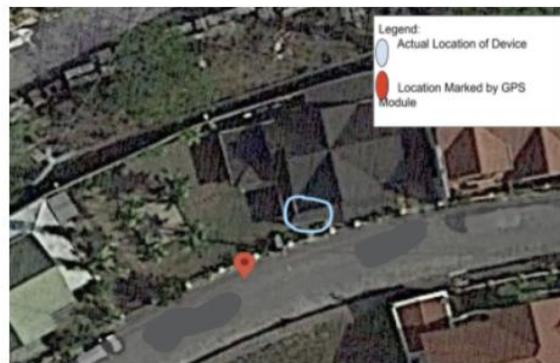

Fig. 9. The GPS module's data regarding the GPS coordinates on Trial 1

Furthermore, the GPS is a navigation system that has a range of antenna gain 50 dB. By obtaining the coordinates and inputting it in Google Maps, the GPS data, highlighted by the red pin is seen to be relatively close to the actual location of the device.

Table 3. Data analysis for GPS module

Accuracy of GPS Module in Documenting Coordinates	
Mean	7.2510
Standard Deviation	4.5876
Variance	21.046
Estimation of Parameters (One Population Mean) ² at $\alpha = 5\%$	7.2510 ± 2.8434
Hypothesis Testing (One Population Mean) ² at $\alpha = 5\%$, t-test	Ho: $\mu = 12.5$; Ha: $\mu < 12.5$ p-value: 0.0001, $t < 1.8331$ or $p < 0.05$, reject Ho.

3 - Reference parameters of error readings of GPS coordinates obtained from Islam and Kim (2014); $\mu: 12.5$ m

Table 3 shows that the GPS module accurately identified the GPS coordinates, with a mean error reading of 7.251 meters from the device's actual location. The mean error distance of the GPS readings is also significantly lower than the error readings obtained by Islam and Kim (2014). Conclusively, the GPS module is more accurate and precise in recording data.

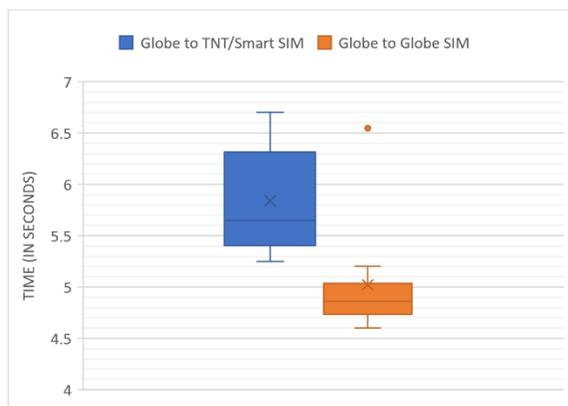

Fig. 9. The data of the GSM regarding communication through text messaging.

Table 4. Data analysis for GSM text messaging.

Length of time for messaging to be sent using GSM Module	SMART/TNT SIM	GLOBE SIM
Mean (s)	5.842	5.022
Standard Deviation	0.4988	0.5330
Variance	0.2488	0.2841
Estimation of Parameters (Difference of Two Population Means) at $\alpha = 5\%$	0.8200 ± 0.4525	
Hypothesis Testing (Difference of Two Population Means) at $\alpha = 5\%$, t-test	Ho: Smart = Globe Ha: Smart > Globe p-value: 0.9998, $t > 1.645$ or $p > 0.05$, reject Ho.	

Meanwhile, the GSM module allows the Arduino board to send and receive SMS and make voice calls using the GSM library. The mean length of time for sending a message to TNT or Smart SIM is 5.842 s, while Globe SIM is 5.022 s. The time difference between the SIMs is significant since the device must send out information quickly. Thus, the Globe SIM is more efficient for GSM text messaging. Moreover, Mr. Nahial stated that cell towers are available in Cordillera since it is used by the people living near the forest. Obanda (2017), who used a SIM900 module, found that text messages took as little as 45 seconds and as long as 80 seconds, which is longer than FoFi's data. However, this could be due to the different carriers they used and other factors.

4. CONCLUSIONS

Forest fires are natural disasters that endanger natural and human resources. In the Cordillera region in the Philippines, data science is being used to predict the subsequent forest fires, prompting the researchers to create a handheld device that forest rangers can use to gather quantitative data to support the LAWIN system's qualitative data.

Readily available electronic components were interfaced with the Arduino microcontroller and were tested to gauge their performance in the context of forest monitoring. The results showed that the YG-1006 IR sensor is too inconsistent to be used in recreating a similar device. The MQ-2 sensor and photoresistor should be replaced with more capable alternatives. On the other hand, the DHT-22 accurately gathered data for ambient temperature. However, it would require tuning for reading relative humidity. Also, the GPS and GSM modules were effective in identifying coordinates and sending information. Overall, FoFi can significantly contribute to the prediction of forest fires.

5. ACKNOWLEDGMENTS

The researchers would like to express their gratitude to the De La Salle University for the research fund; their research mentors, Miss Sherilyn Abarra, Miss Leah Madrazo, and Dr. Kerry Cabral; their research adviser, Miss Myrlla Torres; and their former robotics teacher, Sir Morris Bana. The researchers would also like to thank the former researcher of DENR, Mr. Sherwin Nahial, together with the FMB Chief under Forest Protection, for helping with the gathering of information regarding forests and forest fire. Lastly, the researchers would like to acknowledge their families and friends for their support while the research was in progress. This research would not have been possible without these people.



6. REFERENCES

- Agoot, L. (2019, March 12). Cordillera records 165 fires in less than 3 months. Philippine News Agency. Retrieved from <https://www.pna.gov.ph/articles/1064363>
- Dumlao, A. (2019, March 8). BFP: 140k hectares of forest in Cordillera damaged in fires since January. Philstar. Retrieved from <https://www.philstar.com/nation/2019/03/08/1899759/bfp-140k-hectares-forest-cordillera-damaged-fires-january>
- Hirschberger, P. (2016). Forests ablaze: Causes and effects of global forest fires. WWF Deutschland. Retrieved from <https://mobil.wwf.de/fileadmin/fm-wwf/Publikationen-PDF/WWF-Study-Forests-Ablaze.pdf>
- Islam, M., & Kim, J. M. (2014). An effective approach to improving low-cost GPS positioning accuracy in real-time navigation. *The Scientific World Journal*, 2014, 1-8. <https://doi.org/10.1155/2014/671494>
- Molina-Pico, A., Cuesta-Frau, D., Araujo, A., Alejandre, J., & Rozas, A. (2016). Forest monitoring and wildland early fire detection by a hierarchical wireless sensor network. *Journal of Sensors*, 2016. <https://doi.org/10.1155/2016/8325845>
- Mukherjee, A. (2016). Smoke detection using mq-2 gas sensor. Retrieved from <https://create.arduino.cc/projecthub/Aritro/smoke-detection-using-mq-2-gas-sensor-79c54a>
- Niranjana, R., & HemaLatha, T. (2018). An autonomous iot infrastructure for forest fire detection and alerting system. *International Journal of Pure and Applied Mathematics*, 119(12), 16295-16302. Retrieved from <https://acadpubl.eu/hub/2018-119-12/articles/6/1512.pdf>
- Obanda, Z. (2017). Multi-sensor fire detection system using an arduino uno microcontroller (Doctoral dissertation, Strathmore University). Retrieved from <https://suplus.strathmore.edu/handle/11071/5686>
- Perez, J. (2017). Causes et consequences of forest fires. Retrieved from <https://www.ompe.org/en/causes-et-consequences-of-forest-fires/>
- Stefanidou, M., Athanaselis, S., & Spiliopoulou, C. (2008). Health impacts of fire smoke inhalation. *Inhalation Toxicology*, 20(8), 761-766. <https://doi.org/10.1080/08958370801975311>
- Thomas, D., Butry, D., Gilbert, S., Webb, D., & Fung, J. (2017). The costs and losses of wildfires. Special Publication NIST SP-1215. <https://doi.org/10.6028/NIST.SP.1215>
- United Nations. (n.d.). Forest Fire. Retrieved from <http://www.un-spider.org/disaster-type/forest-fire>



Electronic Cartero Machine (ECM): An RFID-Based One-Way SMS-Sending Kiosk

Carla Allyxzandra C. Biag
Tarlac Montessori School, Tarlac City, Tarlac

Abstract: The study's goal was to see whether a one-way text messaging machine using RFID will be effective to the students, teachers, and parents/guardians. The study has taken advantage of the school's usage of RFID to record the attendance. The same RFIDs are to be used to register into the Electronic Cartero Machine (ECM). The researchers built a system where students can message their parents/guardians their concerns by tapping the students registered RFID using the Raspberry Pi as a controller to show the GUI (Graphical User Interface) of the system. The main program is custom made using Java SE (Standard Edition) and Swing. There are 20 respondents to the survey, consisting of the students, teachers, parents/guardians, and administrative staffs to evaluate the appearance, maintainability, ease in usage and accuracy. The survey uses general acceptability indicators to describe the mean of the outcome. From the results of the survey, the appearance mean is 4.25 which suggests that the design of the ECM, especially the GUI is clear and identifiable, the maintainability mean is 4.7 which indicates that it can easily be maintained. Ease in usage is 4.9 which means that it can send the text messages to the proper recipients. The overall mean is 4.5675. It scored "Excellent" on the general acceptability indicators. Furthermore, the researchers discovered that the ECM is similar with the regular cellular phones in terms of sending time. Also, the number of characters being sent affects the sending time of the ECM.

Key Words: SMS; RFID; GUI; no cellular phone policy; communication

1. INTRODUCTION

RFID stands for Radio Frequency Identification which is an auto recognition technology that allows RFID reader to read data from RFID tags (labels) via wireless communication or better to say via radio signals from a distance (Scanlan, 2015).

The principle of using RFID to track things is used by many schools today to keep track of the students' attendance, students' time of arrival and departure from school that then texted to the students' parents.

The Lyceum of the Philippines University creates a Laguna Student Electronic Attendance and Logging System. This study was developed to create an electronic attendance and logging system using Radio Frequency Identification (RFID) and Short Messaging Service (SMS) with a web-based management system portal that allows user to access real time data to ensure campus security and smart information management.

Currently, with the widespread use of technology, the Department of Education (DepEd) in the Philippines has issued Department Order (DO) No. 83, s. 2003 - Reiteration to DECS Orders Nos. 70, s. 1999 and 26, s. 2000 - Prohibiting Students of Elementary and Secondary Schools from Using Cellular Phones and Pagers During Class Hours.

With order being implemented, students are not allowed to bring cell phones, an example of a school implementing such policy is the school of the researcher.

In this line, the researcher is making a proactive approach that can help improve communication between students and parents in case a message is needed to convey in any given situation. Using this system, just tap their RFID, screen will be activated, type your message, press send and will automatically send the text message to any GSM network of parent's registered number, then will prompt the message has been sent and will log out automatically to serve the next student.

1.1 Statement of the Problem

The study aims to provide a more efficient system of communication between the students of Tarlac Montessori School and their attending guardians.

The study also aims to answer the following questions:

1. How can the Electronic Cartero Machine be described in terms of:
 1. Appearance;
 2. Maintenance;
 3. Ease in usage ;



4. Accuracy?
2. Is there a significant difference between the ECM and the regular cellular phone in terms of sending time?
3. Is there a significant relationship between the sending time of the ECM and the number of characters sent?
4. What are the implications of the ElectronicCartero machine to the society?

1.2 Significance of the Study

The purpose of this study is to strengthen the communication between the attending guardians and students during the students' time in school. With this study, the school would have an alternative communication system which can be utilized when a student needed to message their parents because of an emergency or because they needed something.

This study will significantly benefit the attending guardians students, and the school administrations.

1.3 Scope

The researchers' proposed system will be using the idea or concept of the current system of the RFID of Tarlac Montessori School (which notifies parents/guardians if their child has entered or left the school campus) and enhance it by adding an SMS so that the student will be able to send a message to the parents/guardians regarding specific topics using their own RFIDs. The system can be used by all schools that have acquired or will acquire for an RFID system.

2. METHODOLOGY

2.1 Experimental Design

The researchers developed an RFID-Raspberry Pi-GSM System to test the one-way text processing system that will be needed in the study. Figure 1 shows the System Block Diagram. The main program is custom made using Java SE (Standard Edition) and Swing [GUI (Graphical User Interface) Development Language for Java] or simply Java program. For an RFID and GSM system to link to Java program, the programmers use AT (Attention), expect and bash (Bourne Again Shell) programming languages. As shown in the Figure 1, the student's ID is used to tap the ID to RFID reader. The RFID reader will forward the information to the data base on Raspberry Pi. The RFID information embedded will served as login authentication to enter the system. The ID should be registered to the system, otherwise a message will prompt that the student is not a registered user and cannot use the system until the student completed the registration process.

System Administrator is responsible to process the addition of user/s in the system. Once the system recognized that the student is a valid user, a GUI (Graphical User Interface) will appear to the LCD monitor processed using Raspberry Pi running on Raspbian OS (Operating System). Java JRE (Java Runtime Environment) is also installed in the Raspbian to run the Java program. The student can send the SMS message to his/her parent's cell phone numbers regardless of their carrier's network. The system is capable to identify and process SMS in any network. The GSM System is used to process any SMS to and from the Raspberry Pi. The sender or student can see two previous successful message sent by the parent or guardian found in Inbox as shown in Figure 4.

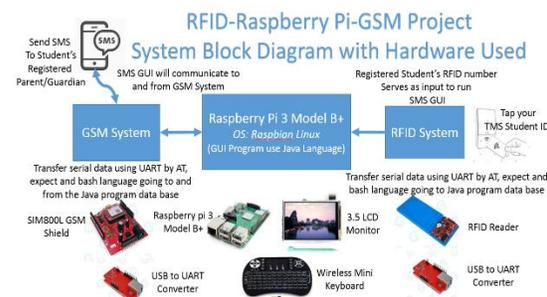

Figure 2. RFID-Raspberry Pi-GSM Project System Block Diagram

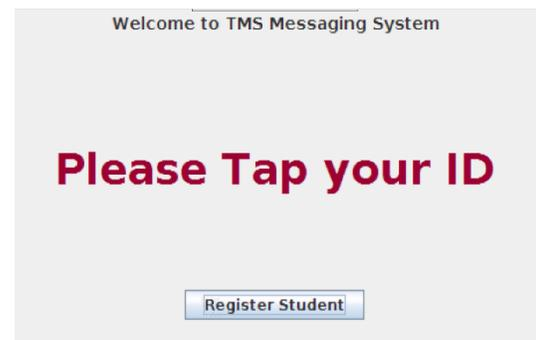

Figure 3. Main GUI Design

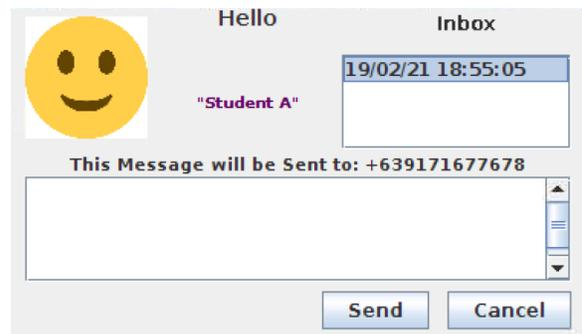

Figure 4. SMS GUI Design

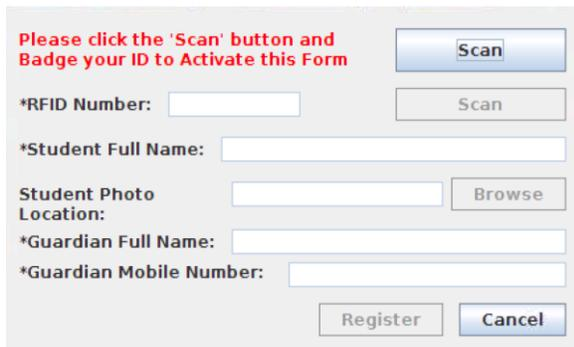

Figure 5 shows the Registration GUI Design

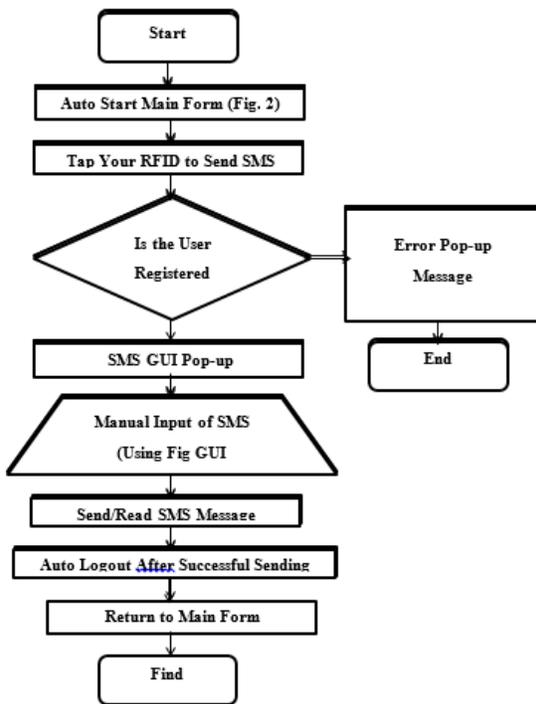

Figure 6. The Flowchart if Sending SMS

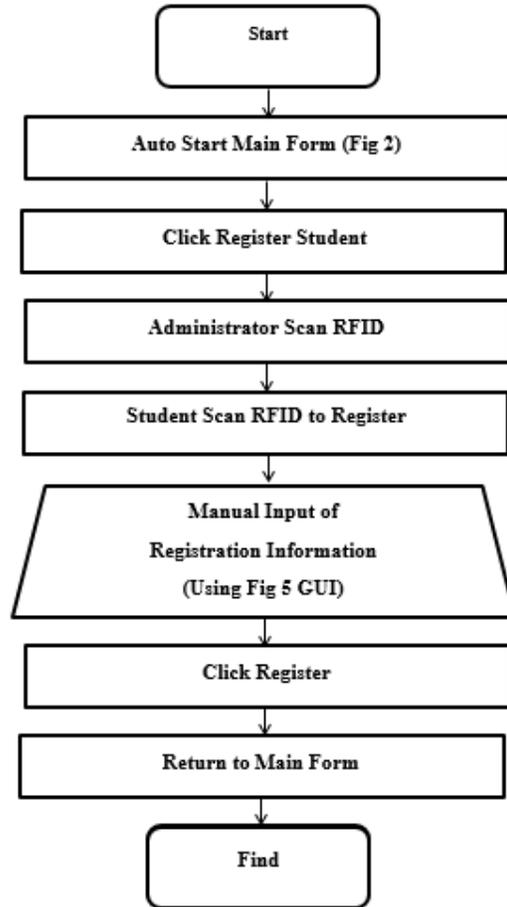

Figure 7. The Flowchart of Registration

The system was tested by random students, teachers, parents/guardian, and administrative staffs using the effectiveness, reliability, and maintainability criteria.

To assure the quality of the RFID-Raspberry Pi-GSM System, the researchers asked the help of the school's System Engineer and Programmer to check and evaluate on the system functionality and make sure that it will be able to send the one-way text message to the parents of the students at any cases and everything is considered. This will be fault proof and be able to correct the bug/s in case it will be found out. Aside from technical checking, the researchers also asked the Systems Engineers to evaluate the system in terms of effectiveness, reliability, and maintainability.



2.2 Experimental Procedures

- A. Assembly and Preparation of Raspberry Pi System and Peripherals
- B. Testing the hardware and system function
- C. Program Design and Programming
- D. Testing, Evaluation, and Prototyping
- E. Respondents' Testing and Evaluation

2.3 Data Gathering Instruments

After the respondents tested the device, the researchers gave them a questionnaire that will rate the device based on the three criteria: effectiveness, reliability, and maintainability. The data that the researchers gathered were used in helping to address the problems that is sought to be answered by the study.

2.4 Statistical Treatment

Statistical Tools were used to measure the appearance, maintainability, ease in usage and accuracy was mean on the one-way text messaging system or RFID-Raspberry Pi-GSM System. The Two Sample T-Test assuming equal variance and the Pearson Product Moment Coefficient of Correlation were used to determine the significant difference and relationships in the study.

Pearson's r
 $r = \frac{nxy - (x)(y)}{n^2 - (x)^2 - (y)^2}$

T-Test
 $t = \frac{1 - 2d_0}{\sqrt{\frac{1}{n_1} + \frac{1}{n_2}}}$

2.5 Indicators

Table 1
General Acceptability Indicator

Integral Value	Interval	Description
1	1.00 – 1.80	Poor
2	1.81 – 2.60	Fair
3	2.61 – 3.40	Good
4	3.41 – 4.20	Very Good
5	4.21 - 5.00	Excellent

Table 1 shows the integral value with the corresponding description of the general acceptability indicator.

3. RESULTS & DISCUSSIONS

These are the findings from the tests conducted in this study and the interpretation of these findings.

Table 2
Average scores of the One-way text messaging system using RFID

Respondents	Mean score per indicator:			
	Appearance	Maintainability	Ease in Usage	Accuracy
High School Teachers	4	5	4.5	5
Grade School Teachers	4.5	4.5	5	5
Pre School Teachers	5	5	5	5
High School Parents	5	4.5	5	5
Grade school parents	3.5	4.5	4.5	4.5
Preschool Parents	3	5	4	5
IT Specialists	4.5	5	5	5
Office Staffs	4.5	4.5	5	4.5
Yayas	4	4.5	5	5
Students	4.5	4.5	5	5
General Average	4.25	4.7	4.8	4.9

Table 2 shows the average score the One-way text messaging system using RFID acquired in terms of appearance, maintainability, ease in usage and accuracy in the survey that was conducted to the following people; two (2) High school teachers, two (2) Grade school teachers, two (2) Preschool teachers, two (2) High school parents, two (2) Grade school parents, two (2) Preschool parents, two (2) IT specialists, two (2) Office staff, two (2) yayas, and two (2) students. Table 2 also shows the general average the One-way text messaging system acquired in terms of the five (5) aspects mentioned.



Table 3
General Description for the One-way text messaging system using RFID

General Acceptability Indicators	Mean Score per indicator	Description per indicator	General Mean	General Description
Appearance	4.25	Excellent	4.5675	Excellent
Maintainability	4.7	Excellent		
Ease in Usage	4.8	Excellent		
Accuracy	4.9	Excellent		

As the table shows, the mean scores the One-way text messaging system using RFID acquired in terms of appearance is 4.25 which translates to excellent in the description indicator. This suggests that the design of the One-way text messaging system, especially the GUI is clear and can be identified easily.

In terms of Maintainability, the One-way text messaging system using RFID garnered a mean of 4.7 which is considered as excellent. This indicates that it can easily be maintained by the people in charge of it and that it is not too costly to operate.

The One-way text-messaging system using RFID, in terms of Ease in Usage, garnered a mean score of 4.8 which is equivalent STET. This means that the One-way text messaging system is easy to understand and operate or that it is user-friendly in general.

With a 4.9 mean score, the One-way text messaging system using RFID is very good in terms of accuracy. This means that the One-way text messaging system is capable of and is good in sending the text messages to the proper recipients. Also, this means that the system can record the correct data (phone number, of students) for each RFID.

Overall, the general mean the One-way text messaging system using RFID acquired is 4.5675 which is considered to be very good. This means that the one-way text-messaging system is acceptable and has received a high score in terms of appearance, maintainability, ease in usage and accuracy.

Table 4
Difference on the Sending Time of the ECM and Cellular Phone

Variables	Means	α Level	df	Critical Value	t-Stat	Decision
ECM	7.09	0.05	8	2.3060	0.4879	Do not Reject Ho
Cellular Phones	7.51					

Table 4 shows the difference on the sending time of the ECM and of regular phones. It can be seen that at alpha level 0.05, degree of freedom of 8, the critical value is 2.3060; comparing this to the computed t-statistic of 0.4879, the null hypothesis is not rejected. Thus, there is no significant difference on

the sending time of the ECM and of regular phones. It can also be inferred that the ECM and the regular cellular phones have the same sending time. Thus, in terms of time in sending, the two resources are just the same.

Table 5
Relationship Between the Number of Characters and Sending Time of the ECM

Variables	Means	α Level	df	Critical Value	r-Stat	Decision
Characters	30	0.05	7	0.666	0.7822	Significant
Sending Time	8.19					

Table 5 shows the relationship between the number of characters sent and the time required to send these by the ECM. It can be seen that at 0.05 level of significance and critical value 0.666 the computed r-stat, 0.7822 will reject the null hypothesis. Thus, there is a significant relationship between the sending time of the ECM and the number of characters sent. This infers that the number of characters being sent by the ECM will affect the sending time of the ECM.

4. CONCLUSION

One of the alternative solution to send SMS inside the school campus from a TMS student to parent if needed is the proposed one-way text messaging.

The prototype is working as expected and can send a SMS to parent/guardian in case of emergency.

This system can be used by the TMS and be able to strengthen the policy of not bringing cell phone inside the campus. Students will have anytime readily mode of emergency communication through one-way text messaging system with their parent or guardian. This can be installed in several units around school strategically and serves as very good additional options to the TMS students.

Using RFID will enable students feel secured. Every student's RFID has unique card number and allow their RFID card to send SMS using the one-way text messaging system provided if they are registered to the system. The data base of registered students will control the access to be able to send SMS to student's registered number of parent/guardian. Also, There is no significant difference between the ECM and the regular cellular phone in terms of sending time. And there is a significant relationship between the sending time of the ECM and the number of characters sent.

5. RECOMMENDATIONS

The prototype made is intended to make the one-way text messaging system work like how to make



the RFID system function and be connected to raspberry pi, how the GSM system sends SMS without fail, and how these two systems collaborated using Java program. Here are the recommendations of the researchers to improve and optimize the system:

1. Upgrade the monitor to 7 inches for better reading and usage experience.
2. Change the RFID reader or module and GSM module to basic board function to lessen the cost of the system,
3. Find the same keyboard size that is easy to use.
4. Explore on using a smaller version of Raspberry Pi which is the Raspberry Pi Zero W model.
5. Design a container or box same size as the 7 inches monitor and RFID reader.
6. Install power bank module that can supply all power requirements of raspberry pi, RFID system, and GSM system.
7. Improve the cooling system to avoid excessive heat accumulating on the container.
8. Optimize the window (GUI) settings that can fit a 7inche screen.
9. Another thorough programming debugging to check possible bugs that will affect the sending of SMS and reading RFID performance.
10. Explore of using GSM modem instead of GSM module. This will enable two or more units share the same number. This is also a cost-effective approach.

Morallo, I. M. (2015). Lyceum Of The Philippines University – Laguna Student Electronic Attendance And Logging System (Lpu-Laguna Seals). *Laguna Journal of Multidisciplinary Research*, 4(3), 1–1. <https://ejournals.ph/article.php?id=10049>

Scanlan, D. A. (2015). An inexpensive RFID attendance system. | *Journal of Computing Sciences in Colleges. Journal of Computing Sciences in Colleges.* <https://dl.acm.org/doi/10.5555/1629036.1629039>

6. ACKNOWLEDGEMENTS

The researcher would like to thank everyone who helped them out in doing the project especially our adviser, Mr. John Henry P. Taguines.

The researcher would also like to thank their parents for supporting them in all the tasks to accomplish.

The researcher would like to thank Mr. Mark Espiritu for giving them his time to help make the program of the text messaging system.

The researcher would like to thank their school directress, Dr. Elizabeth T. Asiaten for trusting them to use the school's resources for their project.

And the One who made it all possible, THE ALMIGHTY GOD, for giving them confidence, courage, perseverance and knowledge to be an instrument for others' transformation.

7. REFERENCES

Ban on use of cell phones during classes gets legislators' support. (2009, June 21). *Philstar.com*; *Philstar.com*. <https://www.philstar.com/cebu-news/2009/06/22/479599/ban-use-cell-phones-during-classes-gets-legislators-support>



Conceptualization of a Surveillance Drone for Aquatic Expeditions

Alfaro, Jio Jose G., Borbon, Kenneth A., and Tacbian, Kristian Rome L.
De La Salle University Integrated School, Manila

Dr. Alvin Y. Chua, *Adviser*; and Engr. Arvin H. Fernando, *Adviser*
De La Salle University, Manila

Abstract: The age of technology has paved the way for technological advancements and inventions, one of which are Unmanned Underwater Vehicles (UUV) which are deployed in marine ecosystems for various purposes. This technology displays the potential of safer and more efficient monitoring methods for marine surveillance. However, in the Philippines, numerous leading marine organizations still use traditional methods such as the use of divers to collect data for research purposes. Thus, it is the study's general objective to conceptualize a UUV model that may be adapted in the Philippines for marine surveillance operations. The study undergoes a 4-step-process in fulfilling the general objective, this involves: (1) the Consultation of Marine Organizations and Personnel, (2) the finding of the Electrical Hardware Components, (3) the Simulation of the Conceptualized Drone Shapes, and (4) the Analysis of the Simulation Results. Through this systematic approach, the study conceptualized 3 drone shapes namely: the Disc Shape, the Torpedo Shape, and the Anomalous Shape. These conceptualized shapes were modeled and simulated through SolidWorks, where the ideal water conditions of the Philippines were set to accurately test the efficiency of these drone shapes. The obtained results suggest that the torpedo shape is the most ideal shape to utilize in Philippine marine surveillance application.

Key Words: unmanned underwater vehicle; conceptualize; SolidWorks; marine surveillance; drone shapes

1. INTRODUCTION

The UUV industry has introduced the viability of UUVs for marine surveillance. The integration of this drone technology underwater can be crucial in aiding long-term inexpensive, more task efficient, and safer practices in conducting underwater expeditions (The Explorer, n.d.). An example would be Irobot's Seaglider, a UUV specifically for surveillance purposes, that displayed the potential of UUVs for a safer and more efficient oceanic monitoring. However, given the diversities in the conditions of the world's bodies of waters, it is necessary to appropriate the drone design with regards to its own environmental challenges. As such, there is a surplus of different UUV designs in the market such as the spherical, torpedo, and anomalous each having their own sets of advantages and disadvantages (Chen & Liu, 2011).

The objective of this study is to conceptualize UUV models that may be adapted in the Philippines for surveillance purposes. The following steps were performed to accomplish the said objective:

1. To consult with various marine related organizations and personnel regarding various information needed for an ideal UUV.

2. To find the different electrical hardware components of the drone.
3. To simulate the hydrodynamics effects of different drone shapes through SolidWorks Flow Simulation.
4. To analyze the results of the simulation and identify the ideal drone shape to use in the Philippines.

The study aims to help various organizations in the Philippines that advocate towards the preservation of marine wildlife and coral reefs as the study conceptualizes UUV models that can be integrated in the Philippines. Furthermore, the study extends knowledge in the field of underwater drones as the study provides comparative data between different shapes of UUVs through the parameters coefficient of drag and drag force.

The primary focus of this study revolves around the effectiveness of various UUV shapes in Philippine oceans. The design aspect of the conceptualized drones relies on the incorporation of the various electrical components specialized for marine surveillance into the different hull shapes. Certain external procedures such as the programming



of the electrical components, actual fabrication of the drones, and post processing of gathered data by the drone is not included in the study. A total of 3 drone shapes were done in SolidWorks: spherical shape, torpedo shape, and manta ray shape. These designs were then tested through SolidWorks Flow simulation to identify their coefficient of drag and drag force.

2. METHODOLOGY

Figure 1

Flow of Methodology

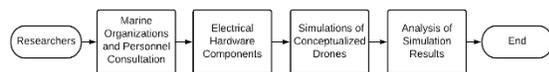

Note. This figure shows the flow of which the objectives were done in sequence.

2.1 Marine Organizations and Personnel Consultation

Following the process seen in figure 1, proper guidance was imperative in setting the groundwork for the study to build upon. A survey was made through Google forms and was administered to various organizations and personnel in the field of marine biology. Personnel from marine organizations such as DLSU SHORE, Coral Guardian, Marine Conservation Ph, and National Oceanic and Atmospheric Administration (NOAA) took part in the survey; which includes inquiries about the ideal specs of an effective UUV while also including questions regarding the respondents' preferred drone shape based on the researchers' 3 initial drafts; the disc, the torpedo, and the manta ray (see Appendix A).

2.2 Electrical Hardware Components

The types of electrical components for the internal and external parts of the drone were selected to accommodate the compiled responses from the survey. The components to be included were centered around features, compatibility, and market availability. The various components were then compiled together in a table presenting their function, weight, quantity, and price (see Appendix B).

2.3 Simulations of Conceptualized Drone

2.3.1 Design Model

The 3 shapes in this subsection were modeled in SolidWorks by the researchers themselves. Every shape consists of the same components in quantity and quality but differs in its placement for each drone. Therefore, the shapes have been designed based on being compact with regards to the volume of the internal components. All of the designs were uniformly made out of 6061 aluminum alloy due to its

reliability in UUV applications. This material is popular in underwater applications as it is corrosive resistant and precipitation hardened (Metal Supermarkets, 2017). A tether was also integrated into the designs since radio waves cannot travel too well through water.

Table 1

Compiled Drone Models

Disc	Manta Ray	Torpedo
		

Note. This table presents the processed models through the use of SolidWorks Visualize for a more presentable look. This however does not change the overall shape and performance of the drones.

To model the disc shape seen in table 1, it was divided into two areas: the main component area and the outer ring area. To achieve this disc shape, 4 thrusters were mounted vertically along the x-axis of the outer ring area at an equal distance from one another. The concept behind the positioning of these thrusters is based on the thrusters of quadcopters. The outer ring area is connected to the main component area through the use of watertight enclosures that also functions as a means for the wiring of the thrusters to be safely connected to the main component area. The main component area comprises the electrical components necessary for the drone to function. Located on the side of the main component area is the pH sensor while below it is the mounted camera, temperature sensor, and depth pressure sensor. The 2 Subsea lights are located separately; one is located directly at the top of the main component area, while the other is located directly below the main component area.

Now for the modeling of the manta ray shape in table 1, the position of the thrusters is as follows: 2 thrusters mounted vertically for upward and downward motions, and 2 thrusters mounted horizontally for propelling the drone forward. Although the thrusters are mounted at different orientations, the thrusters were however aligned at the same axis with each other for them to function as intended. This is done in order for the drone to have stability while thrusting the drone forward. However, due to the 2 thrusters positioned at the back, a hollow passage was implemented in order for them to have access to water flow. For the other external components of the drone, the water quality sensors are allocated on a chin compartment below the hull; While



the internal components, the camera, and the two subsea lights are located inside the hull.

For the last design in table 1, the torpedo shape, there are 4 thrusters that are all positioned equidistant to each other located at the back of the drone where it can propel the drone forward. The other external components of the drone such as the water quality sensors and tether are also positioned in the back, while the camera and the subsea lights are allocated inside a chin compartment below the craft so that graphical recording is directed frontside of the drone's axis.

2.3.2 Actual Simulations

To set up the simulation environment, the following options were selected from the wizard command: external analysis excluding all cavities and internal spaces for the analysis type, water with a density of 1,023.6 kg/m³ for the fluid to be considered, and default for the wall conditions. According to Sea temperature (n.d.), the lowest recorded water temperature in Manila for the past years is 25°C with a corresponding density of 1,023.6 kg/m³. Due to the inverse proportion of temperature and density, using this temperature is tantamount to simulating the drones at the highest density. Now for the initial velocity condition, this was set to 1.5 m/s and 2.0 m/s derived from other drones that were considered (see Appendix C). However, due to the disc shape's design, two (2) assumptions were made in terms of how the initial velocity condition should be directed based on how it should be moving. First, if the thrusters can tilt, then the drone's movement should be parallel to the x-axis. Second, if the thrusters are fixed in its orientation, then the drone's movement should be approximately around 45° from the x-axis. The mesh settings used in the simulations can be seen in table 2 wherein these were set to: initial mesh level of 4, refining fluid cells level of 3, and refining cells at fluid/solid boundary level of 4.

Table 2
Mesh of the Drone Models

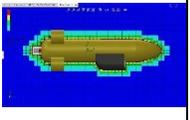
Disc	Manta Ray	Torpedo
		

2.4 Analysis of Simulation Results

The effectiveness of each UUV shape was based on the parameters: coefficient of drag and drag force. Thus, it was imperative to analyze the said

parameters in conjunction to the pressure contours and velocity flows. The analysis of the parameters was done via comparison and transparency checking with regards to present-day data. Important concepts such as the reference area and streamlined bodies were also considered in the analysis.

3. RESULTS AND DISCUSSION

3.1 MARINE ORGANIZATIONS AND PERSONNEL CONSULTATION

Table 3
Responses from the Consultation

Marine Organization/ Personnel	Recommended Electrical Hardware	Recommended Battery Duration	Recommended Operational Depth	Preferred Drone Shape
Director of DLSU Shore	Temperature Sensor	2 to 3 hours	50 meters	Spherical
Marine Ecologist of NOAA	Alkalinity Sensor Temperature Sensor	3 to 4 hours	30 to 50 meters	Torpedo
Marine Conservation Ph	pH Sensor Temperature Sensor	2 to 3 hours	40 or 150 meters	Torpedo
Coral Guardian	pH Sensor Temperature Sensor	2 to 3 hours	Purpose Dependent	Spherical

Note. Presented in this table are the summarized responses that were considered by the researchers in conceptualizing the disc, torpedo, and manta ray shapes.

3.2 Conceptualized Drone Simulations

Table 4
Compiled Simulation Results

Simulation Results at 1.5 m/s		
Drone Shape	Coefficient of Drag	Drag Force
Disc at 0°	-0.5585	-36.05
Disc at 45°	-0.1318	-49.31
Manta Ray	-0.4576	-27.63
Torpedo	-0.7927	-16.49
Simulation Results at 2.0 m/s		
Disc at 0°	-0.5596	-64.20
Disc at 45°	-0.1273	-84.69
Manta Ray	-0.4790	-51.42
Torpedo	-0.7928	-29.33

Figure 2
Coefficient of Drag vs Velocity

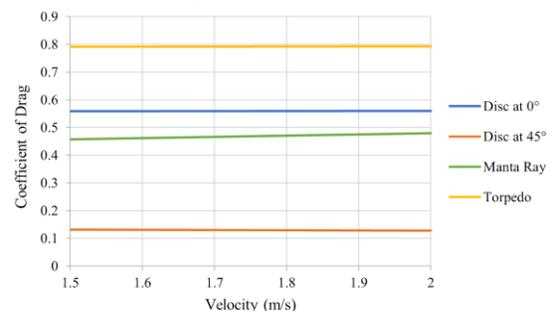

Figure 3
Drag Force vs Velocity

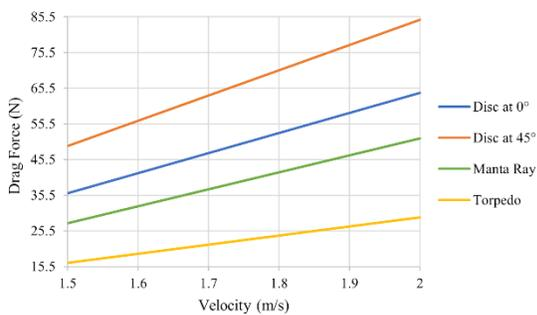
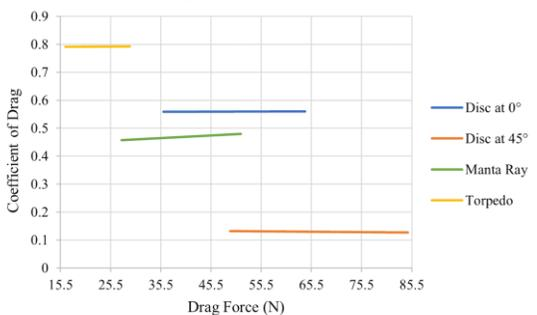

Figure 4
Coefficient of Drag vs Drag Force



As presented in figure 2, it can be noticed that among the 3 shapes, the disc shape at its second assumption, when it is angled at 45° from the x-axis, had the lowest coefficient of drag. An explanation to this is that among the factors that affect the drag equation, the reference area has an inverse relationship to the coefficient of drag (NASA, n.d.). This means that as the reference area increases, the coefficient of drag should decrease. Consequently, the disc at its second assumption had the least coefficient of drag while having the largest reference area among the other shapes as seen in table 5. This is consistent with the result obtained from the torpedo wherein the torpedo shape, which has the smallest reference area, had the highest coefficient of drag.

However, the coefficient of drag is not the sole determinant in the drag equation. According to Restarts (n.d.), drag force, the force obtained in the drag equation, is dependent on numerous other variables such as density, velocity, and shape. This explains the data seen on figure 3 wherein the disc at its second assumption yielded the highest drag force despite it having the lowest coefficient of drag. The reason behind its high drag force attributes to the flow of fluid with regards to its shape. Referring to table 6, it can be observed that heavy turbulence is experienced at the rear of the drone. In contrast to this, the torpedo shape experienced a more streamline flow of fluid that correlates to less agitation or

turbulence of fluid particles as it moves through a body (Swan, 2011). This resulted in a lower drag force despite its higher coefficient of drag.

Table 5
Compiled Pressure Contour

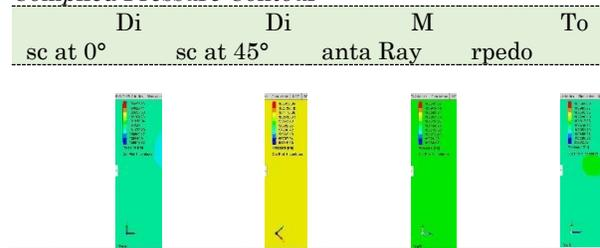
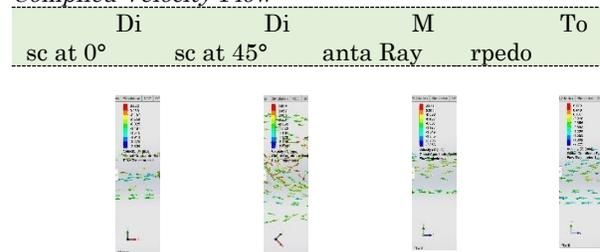

Table 6
Compiled Velocity Flow



4. CONCLUSION

This study, which aims to develop UUV models that can be adapted in the Philippines, has found out that based on the survey conducted, an ideal UUV should have 3 hours operational time and a depth rating of at least 30 meters. Moreover, the disc and torpedo shapes are preferred drone shape amongst the survey respondents. Now referring to the results seen in table 3, it can be inferred that based on the discussion in section 3, the ideal drone shape for the Philippines would be the torpedo. There were 2 bases for this interference. First, despite the torpedo's coefficient of drag being the highest, it was the closest one to the acceptable coefficient of drag value for underwater purposes. The coefficient of drag for most vehicles based on the cross-sectional area ranges from 0.8 to 1 (Marine Technology Society, 2017). Furthermore, the torpedo shape obtained the lowest drag force amongst the other drone designs. A similar observation was made in the thesis of Shah (2008) wherein he stated that torpedo shapes experience less drag compared to that of non-torpedo shapes.

For the proceeding studies to be conducted, a possible area of improvement for this research would be to consider upward and downward motions as well to investigate the lift force of the shapes. Moreover, simulation software that uses tetrahedral meshes such as Ansys could also be used to further improve the study as the SolidWorks Flow Simulation was only



limited to cuboid meshes. Lastly, a significant rendition of this study would be to fabricate the drones for actual experimentations.

5. ACKNOWLEDGEMENTS

The researchers wish to extend their sincerest gratitude to their families, research advisers, partners, survey respondents, and peers. The study was completed in recognition to the major contributions of guiding mentors namely; Dr. Alvin Chua, our research adviser, for guiding us towards the right trajectory; Engr. Arvin Fernando, our research adviser, for assisting us in completing the study; Engr. Isidro Marfori, our SolidWorks adviser, for aiding us in learning SolidWorks; Engr. Jeremias Gonzaga, the DLSU SolidWorks Coordinator, for lending us a licensed copy of SolidWorks Flow simulation. The researchers also recognize the significance of the study's survey respondents which set the groundwork for the study to stand upon. These contributions together with the perseverance of the researchers has enabled them to complete the study whilst imparting with them an unforgettable experience.

6. REFERENCES

Chen, Q., & Liu, J. (2011). Analysis of shape and general arrangement for a UUV. *Journal of Marine Science and Application*, 10, (1), 121-126. doi:10.1007/s11804-011-1051-8

Marine Technology Society. (2017). ROV APPLICATIONS-DESIGN-DRAG. https://web.archive.org/web/20190921045058/http://rov.org/rov_design_drag.cfm

Metal Supermarkets. (2017). Marine Grade Metals. <https://www.metalsupermarkets.com/marine-grade-metals/>

Nasa. (n.d.). The Drag Coefficient. <https://www.grc.nasa.gov/www/k-12/airplane/dragco.html>

Restarts. (n.d.). The Drag Equation. <https://www.fp7-restarts.eu/index.php/home/root/state-of-the-art/objectives/2012-02-15-11-58-37/132-drag.html>

Sea temperature. (n.d.). Sea water temperature in Manila today. <https://seatemperature.net/current/philippines/manila-sea-temperature>

Shah, V. (2008). Design considerations for engineering Autonomous Underwater Vehicles (Master's thesis, Massachusetts Institute of Technology). https://www.researchgate.net/publication/38000346_Design_considerations_for_engineering_Autonomous_Underwater_Vehicles

Swan, C. (2011). Streamline Flow. Thermopedia. doi: 10.1615/AtoZ.s.streamline_flow

The Explorer. (n.d). Underwater drones for ocean inspection and exploration. <https://www.theexplorer.no/solutions/underwater-drones-for-ocean-inspection-and-exploration/>

7. APPENDICES

Appendix A Survey Questionnaire

Figure A1
Compiled Survey Questionnaire

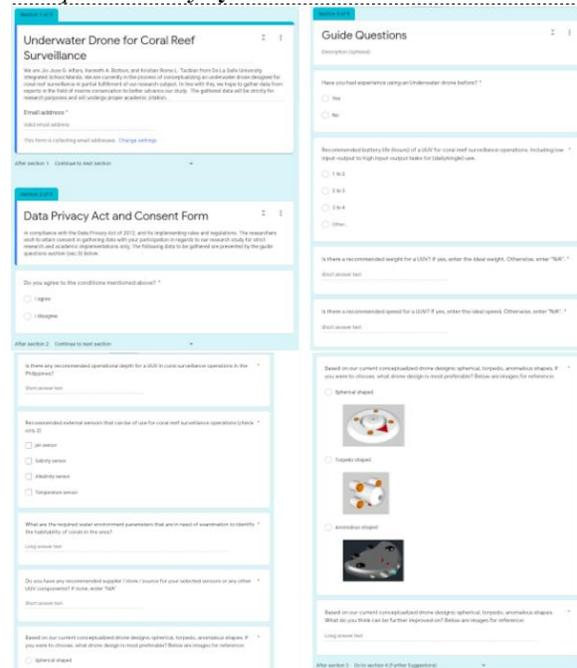

Appendix B Electrical Hardware Components Table B1

Internal Electrical Hardware Components

Component	Function	Weight	Quantity	Total Price
Pixhawk Autopilot	An advanced autopilot/command center through which each command is taken and translated to the other components of the drone	33.3 grams	1	\$170.00
ZTW 40A Brushless ESC	A non-physical controller that indicates the speed of the thrusters' speed.	36 grams	4	\$72.00
BlueRobotic Power Sense Module	A module that provides current and voltage sensing to the Pixhawk autopilot	Not indicated	1	\$31.00
Fathom x Tether Interface Board Set	A tether interface board that Enables HD video and high-bandwidth data over 300m+ tether lengths.	N/A	2	\$338.00
Raspberry Pi 3 Model B+	A credit-card sized computer with a 1.4GHz 64-bit quad-core processor, dual-	45 grams	1	\$48.00



3RD DLSU SENIOR HIGH SCHOOL RESEARCH CONGRESS

COMPUTER AND SOFTWARE TECHNOLOGY, AND ROBOTICS

	band wireless LAN, Bluetooth 4.2/BLE, faster Ethernet, and Power-over-Ethernet support			
BlueRobotic 16 GB SD card preloaded with Raspian for ArduSub	A micro SD card preloaded with the Raspbian Linux Operating system and is preloaded with the software needed for ArduSub	Not indicated	1	\$16.00
BlueRobotic Left-Angle Micro USB Cable for Raspberry Pi to Pixhawk	A cable capable of connecting a Micro-USB to USB-A cable which can be connected to the Raspberry Pi computer and Pixhawk autopilot	23 grams	1	\$10.00
BlueRobotic 5V 6A Power Supply	A simple voltage regulator that provides a steady 5V at up to 6A for Raspberry Pi and Pixhawk servo rail.	Not indicated	1	\$22.00
HiLetgo MPU9250 Gyroscope, accelerometer, magnetometer sensor	A powerful inertial measurement unit (IMU) for Raspberry Pi 2/3/4 that adds X, Y, Z axis-functions for determining acceleration, and magnetometer sensor.	2.72 grams	1	\$8.99
Battery	A custom-made battery-pack that accommodates the required electrical output of the 4 thrusters and other components	Not indicated	1	

Table B2
External Electrical Hardware Components

Component	Function	Weight	Quantity	Price
GAOHAU pH 0-14	An underwater pH sensor with a pH range of 0-14 pH and <= 1 minute.	136.078 grams	1	\$40.99
BlueRobotics Celsius Fast-Response, ±0.1°C Temperature Sensor (I2C)	An underwater temperature sensor has an accurate sensor of down to tenths-celsius and a fast response/reading time of (0.5 m/s flow).	Not indicated	1	\$60.00
BlueRobotics Bar30 High-Resolution 300m Depth/Pressure Sensor	An underwater pressure sensor for 300m depth operating capacity and depth resolution of 2mm.	Not indicated	1	\$72.00

BlueRobotics Low-light HD USB Camera	An underwater camera based on the Sony IMX322 with a 1/2.9" sensor and a 2MP-1080p pixel count; to attain maximum light sensitivity.	Not indicated	1	\$99.00
BlueRobotics Lumen Subsea Light	An underwater observation light with a fully dimmable PWM and has a light efficiency output of 1500 lumens at 15 watts. Its beam is rated with a 135° coverage and 6200k color temperature.	Not indicated	1	\$115.00
Hawk Hobby Underwater Thrusters	An underwater reversible thruster with 860 RPM and rated at 300W max power.	163 grams	1	\$49.99
Camera Mount	A custom-built 3D CAD camera mount for the BlueRobotic Low-light HD USB Camera	Not indicated	1	Not applicable
Fathom ROV Tether	A 70-meter polyurethane jacketed tether connected to the drone's tether interface board which connects the drone to the topside computer.	Not indicated	1	\$350.00
Microsoft Xbox One Controller	A wired/wireless gamepad controller is compatible with Windows 10 or Linux operating systems.	281 grams	1	\$59.99
Topside Computer	A topside Windows 10 os operating device with 8GB ram, i5 processor, and	Not indicated	1	649\$



	solid-state drive (SSD).			
--	--------------------------	--	--	--

Appendix C
Research and Commercial Drone Specifications

Table C1

Available Drone Specifications

Disc Drones				
Drone	Max Speed	Battery Duration	Battery Capacity	Max Depth
Kiro Developed Drone	2.1 m/s	Not indicated	Not indicated	Not indicated
Underwater Disk Robot	2.57 m/s	Not indicated	3000W	Not indicated
Spherical Auv	Not indicated	Not indicated	8kWh	150 meters
Four Rotor Dish Drone	Not indicated	Not indicated	Not indicated	Not indicated
Torpedo Drones				
Bluefin-21	2.3 m/s	Not indicated	13.5 kWh	4500 meters
SPURV	1.95 m/s	5 hours	Not indicated	3650 meters
REMUS-100	2.6 m/s	Not indicated	1.5 kWh	100 meters
Anomalous/Commercial Drones				
PowerDolphin	4.5 m/s	2.0 hours	5,800 mAh	Not indicated
iBubble	1.5 m/s	1.5 hours	Not indicated	60 meters
Fifish V6	1.5m/s	4 hours	9000 mAh	100 meters
Gladius Mini	2.0 m/s	2 hours	5000 mAh	100 meters
Blueye Pioneer	1.5m/s	2 hours	96 Wh	150 meters



The Rise of Dough: Mid-Pandemic Baked Desserts Startups

Nicole Cammylle A. Beltran, Juliana Andrea S. Ferrer, Asti Alfonso B. Orenca
Mary Charlene Nicole C. Tan, and Godwin Boan A. Canlas
De La Salle University Integrated School, Manila

Abstract: Since the Philippines implemented the COVID-19 community quarantine, many Filipinos either lost their jobs or stopped going to work. Due to lack of a stable income source, many Filipinos resorted to selling various items, including baked goods, via online platforms. This study aimed to explore the phenomenon and its corresponding factors on the emergence of startups that mainly sell baked desserts on Facebook and Instagram during the quarantine period in Metro Manila. The researchers investigated whether external factors (i.e., social-cultural circumstances and economic circumstances) and internal factors (i.e., intrinsic motivations and attitudes toward baked desserts) affected the rise of baked desserts startups. The researchers also investigated the consumer's decision to establish an online baked desserts startup during the pandemic. In the end, the researchers found out that the consumers' intrinsic motivation played the most significant role in influencing consumer decision to begin an online baked dessert startup, which links to external factors. Additionally, attitudes toward baked desserts only affected the menu and business planning; but did not motivate consumers to start selling due to their love for eating baked desserts. Despite such, external and internal factors contribute to the emergence of baked desserts businesses during the pandemic. The findings of this study provide insight into the mid-pandemic state of the online baked desserts industry.

Key Words: baked desserts startups; online businesses; COVID-19 pandemic; consumers; entrepreneurs

1. INTRODUCTION

Since the onset of the COVID-19 pandemic early March 2020, the strictly imposed nationwide community quarantine forced Filipinos to stay at home and businesses to shut down. Most Filipinos lost their jobs (Department of Labor and Employment, 2020) and had to find a way to make ends meet. Meanwhile, businesses' physical closure allowed potential proprietors to enter the marketplace via online shopping sites and social media (Dannenberg et al., 2020; Gibreel et al., 2020; Zhang et al., 2020). The estimated number of registered online businesses in the Philippines grew from 1,700 in March 2020 to over 68,000 as of August 10, 2020 (Crismundo, 2020).

Furthermore, the COVID-19 pandemic resulted in consumer panic buying, thus reducing bread in groceries and supermarkets (Campos, 2020; Easterbrook-Smith, 2020). Not being able to access bread products when they craved for them caused consumers to bake the goods independently (Easterbrook-Smith, 2020; Wolf & McQuitty, 2013, as cited in Kirk & Rifkin, 2020). Some consumers showed a negative attitude toward baked desserts (Laguna et al., 2020). Others consumed sugary foods to mitigate stress and better their mood, considering the pandemic (Di Renzo et al., 2020).

Since the consumers could not go outside, they spent more time at home and engaged in baking (Bracale & Vaccaro, 2020). Baking became their means of coping with boredom and stress; and bonding with their family (Bracale & Vaccaro, 2020; Easterbrook-Smith, 2020). As the pandemic deprived them of control toward aspects of their life, the consumers continued baking out of confidence in their capabilities (Mochon et al., 2012, Kirk et al., 2015, as cited in Kirk & Rifkin, 2020). Some even imparted their baking experiences and outputs with others because they felt happy for doing so (Belk, 2014, as cited in Kirk & Rifkin, 2020).

Eventually, those consumers became entrepreneurs to solve a consumer problem (Hamdi-Kidar & Vellera, 2018). Such is more likely to happen at life periods marked by minimal risk to one's profession (Hamdi-Kidar & Vellera, 2018). Second, they considered the current cultural conditions of COVID-19 and needed to adapt to the so-called 'new normal' (Ratten, 2020). Given the pandemic, they also wanted to provide their families with adequate funds while enjoying a lifestyle aligned with their values (Ratten, 2020).

The psychological reactance theory states that any perceived threat to freedom arouses reactance, as shown in Figure 1 (Clee & Wicklund,

1980). Hence, if an individual gives high importance to their lost liberty, it would be imperative for them to do acts that would allow them to immediately establish their lost freedom (Clee & Wicklund, 1980). Comparably, the pandemic imposed mobility restrictions among consumers of baked desserts, who then reacted by baking and selling dessert goods in an attempt to regain their freedom.

Figure 1
Psychological Reactance Theoretical Framework

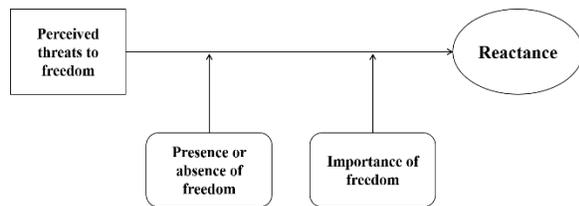

Note. Adapted from “Consumer Behavior and Psychological Reactance” by M. A. Clee and R. A. Wicklund, 1980, *Journal of Consumer Research*, 6(4), 389-405 (<https://www.jstor.org/stable/2488740>). Copyright 1980 by Oxford University Press.

The researchers noticed a significant rise in the number of Filipino consumers who baked and started an online baked desserts business during the pandemic (Arnaldo, 2020; Navarette, 2020; Nepomuceno, 2020). As of this writing, no present studies exactly addressed the factors that led to the given mid-pandemic phenomenon. Hence, this study aims to investigate the said factors by answering the following questions:

1. How did the pandemic-induced socio-cultural circumstances motivate the consumers to start an online baked desserts business?
2. How did the pandemic-induced economic circumstances drive the consumers to start an online baked desserts business?
3. How did one’s intrinsic motivations urge the consumers to become entrepreneurs of baked desserts during the quarantine period?
4. How did one’s attitudes toward baked desserts influence the consumers to establish a baked dessert startup amidst the pandemic?

2. METHODOLOGY

2.1. Conceptual Framework

The researchers posited different factors (independent variables) behind the emergence of baked dessert startups (dependent variables) during a health crisis. The independent variables of the study are classified into external and internal factors. External factors consist of the socio-cultural and

economic circumstances induced by the COVID-19 pandemic. On the other hand, internal factors comprise the intrinsic motivations and attitudes toward baked desserts that consumers govern in their minds. Given the conceptual framework in Figure 2, the researchers hypothesized that (1) socio-cultural circumstances, (2) economic circumstances, (3) intrinsic motivations, and (4) attitudes toward baked desserts drove the consumers to start a baked desserts business.

2.2. Research Design

The researchers employed an exploratory qualitative research study method to understand and uncover the reasons and factors that influenced the consumers to begin baked desserts businesses amidst the pandemic. Hence, they interviewed business owners whose menu only consisted of baked desserts from the beginning of their operations until the researchers’ data collection phase throughout the pandemic.

2.3. Participants

The bases of operations of the selected business-participants had to be in any city of Metro Manila. Second, they had sold their products on Facebook and Instagram, which were among the most frequently used social media applications that enabled said businesses’ information to reach more customers (Nistor, 2020). Applying Slovin’s formula, the determined number of participants was 100. However, given the circumstances arising from the pandemic, only 51 eligible respondents were interviewed.

2.4. Data Collection Process

The interviews were held entirely online through oral and written methods. The researchers met with the participants through a video meeting via Zoom or Google Meet for the former. Meanwhile, the latter method utilized Google Docs, wherein the participants answered a Google document containing the interview questionnaire at their chosen time.

2.5. Data Analysis Process

The researchers used qualitative content analysis to analyze the collected data and answer the research questions. It is divided into five phases, namely, (1) reading the data intensively, (2) building the coding frame, (3) coding the data, (4) analyzing the coded data, and (5) presenting the results (Kuckartz, 2019).

Figure 2
Conceptual Framework on Mid-Pandemic Baked Dessert Startups

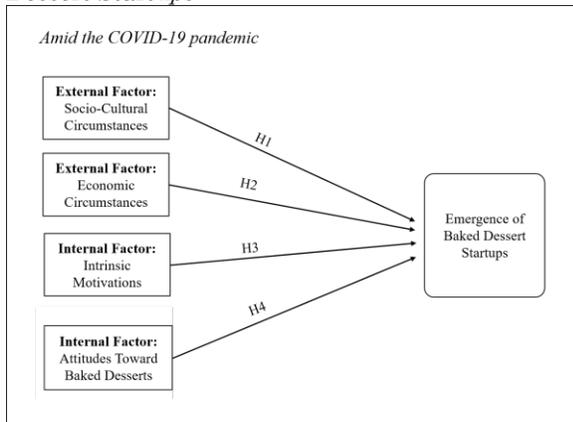

Note. The conceptual framework shows that external factors and internal factors influence the emergence of baked dessert startups during the COVID-19 pandemic.

3. RESULTS AND DISCUSSIONS

3.1. Socio-Cultural Circumstances

The consumers' socio-cultural circumstances entail certain events—whether online or physical—during the pandemic that involve their social networks. As it turns out, the establishment of online businesses by peers and relatives positively influences consumers in establishing businesses by challenging them to do the same and go out of their comfort zone, learn new baking or management skills, or exhibit their baking capabilities. The practice of posting pictures of baked desserts on social media, meanwhile, prompted consumers to bake as a pastime and analyze the market and its baked desserts preferences. Similarly, popular social media trends allowed consumers gain market insight and try something new, which affected the consumers' motivation and menu planning. Most consumers decided not to follow food trends to differentiate themselves from their competitors. The emergence of online businesses inspired consumers to believe that they could be successful. Lastly, getting persuaded and receiving support and advice from their social networks pushed the consumers to start selling their outputs.

“Seeing these posts have [sic] enlightened me that baked goods are “in” during this pandemic and that a lot of people are interested in them. Personally, I spent my time baking different things and learning about its process. I realized, ‘Why not make something out of this?’”

3.2. Economic Circumstances

Economic circumstances are induced by government-imposed lockdown measures and impact the consumers' livelihood and the economy of their surroundings. Consumers saw the establishment of their online business to augment their financial needs, hence establishing their baked desserts startup. Despite this, consumers believe that having an online baked desserts business cannot guarantee a stable income. The business's profitability depends on its management strategy, advertising strategy, and popularity among customers. Some consumers who were able to go out mentioned a surplus in the supply of baked desserts or a shortage in ingredients for baking desserts; both attributed to the heavy saturation of online baked desserts businesses. This motivated the consumers to sell their baked desserts.

“It [shortage of baked desserts] challenged us to place our brand above others, aware that the competition is saturated.”

3.3. Intrinsic Motivations

The American Psychological Association (n.d.) defines intrinsic motivation as “an incentive to engage in a specific activity that derives from pleasure in the activity itself (e.g., a genuine interest in a subject studied).” It is the consumer's internal reason as to why they sold baked desserts during the pandemic. Before the pandemic, consumers already baked desserts as their pastime and were interested in starting a baked desserts business. However, the lack of time and money restricted them from doing such. When the pandemic confined them to their homes, changed their circumstances, and gave them free time, the consumers decided to sell their baked desserts. Consumers baked desserts—whether for the first time or not—and created a business to cope with the pandemic and its socio-cultural and economic circumstances. Through such, they were able to alleviate stress, distract themselves, remain productive, ease boredom, strengthen their familial and social relationships, and learn a new hobby or leisure activity. Furthermore, it provided an opportunity to learn how to manage a business and gain income amidst the pandemic. Consumers also expressed the desire to alter their lifestyle during quarantine by modifying their prior habits, improving skills, and changing jobs with their business.

“It [establishing a baked desserts business] really helped us put all the time we had in our hands to good use. And since there is a pandemic, we were still able to connect with friends and family who we have not seen in a while because they order from us.”



3.4. Attitudes Toward Baked Desserts

Attitudes toward baked desserts involve the preferences of the consumer-turned seller and their buyers toward the product from the former's perspective. As it turns out, not all current baked dessert startup owners were regular consumers of baked desserts. Instead, they became baked dessert startup owners simply because they liked baking and were influenced by their socio-cultural circumstances, economic circumstances, and intrinsic motivations. Nonetheless, they are regarded as "consumers" in this study as they consume or try their baked products. Therefore, attitudes toward baked desserts influence consumers' motivation to establish their startup by increasing their confidence in the products they sell. Some consumers were encouraged to do so by their personal baked dessert preferences. They tend to believe that the market would also patronize their baked desserts, which they find delicious. Also, the consumers can enjoy the process of baking the desserts they love while being able to eat them afterward. In terms of menu and business planning, most consumers considered their potential customers' preferences, either alone or alongside theirs, to attract customers and appeal to a broader market. Overall, attitudes toward baked desserts only play a small part in influencing the consumers' motivation in starting a business.

"I do not sell something that I do not like because it defeats its purpose of me enjoying it while I bake them. At the same time, in order to gain more customers, I also had to consider their preferences, and we have to adapt in an ever-changing community."

4. CONCLUSION AND RECOMMENDATIONS

In the end, it was found that the consumers' intrinsic motivations, which play the most significant role in influencing consumer decision to begin a baked dessert startup, are linked to other internal factors (i.e., intrinsic motivations and attitudes toward baked desserts) and other external factors (i.e., economic circumstances and socio-cultural circumstances). The consumers' attitudes toward baked desserts, meanwhile, only have little influence on their motivation as it only influences menu and business planning; but does not precisely motivate a consumer to start selling due to their love for eating baked desserts. Despite such, it can be concluded that socio-cultural circumstances, economic circumstances, intrinsic motivations, and attitudes toward baked desserts influence the consumers' motivation in establishing a business.

Hence, combining these four factors contributes to the emergence of baked dessert goods

businesses during the pandemic. The findings of this study establish that entrepreneurship is a viable way for consumers of baked desserts to cope with the pandemic in an instance of job loss, stress, and boredom. The study also allows potential and current consumers-turned-sellers in the baked desserts industry to assess saturation and profitability.

The researchers recommend that future researchers employ a quantitative methodological approach to prove the current study's results empirically. Furthermore, they can also widen the range of participants by gathering data from online baked dessert businesses in the other regions of the Philippines and interviewing baked desserts businesses that established a physical store even before the pandemic.

For current and potential businesses, the researchers recommend the business owners to improve marketing, administrative, and financial strategies to stay profitable in the industry, given the rise in the number of competitors. They also recommend baked desserts goods business owners to consider the risks of entering the baked desserts industry and its corresponding solutions, as its market becomes more saturated and competitive.

5. ACKNOWLEDGMENTS

The proponents would like to acknowledge those who contributed and supported them throughout, for, without them, this paper would not have been possible. First, De La Salle University-Integrated School Manila sharpened the proponents' skills in research and taught them the value of having Faith, Service, and Communion in whatever they do. They would also like to thank their Senior High School professors for teaching them various lessons that were applied in the paper and helping them stay away from the temptations of plagiarism and dishonesty; Sir Reynaldo Mones, the researchers' thesis adviser, for sharing his knowledge and wisdom; and Ms. Candice Perez, the researchers' class adviser, for her unending support and guidance throughout their research, which was essential in the success of the project.

Furthermore, the researchers would like to acknowledge the wonderful online baked dessert business owners who sacrificed their time and effort for the interview. Without their responses, the completion of the paper would be impossible.

The researchers would also like to extend their gratitude to their peers and blockmates, ABM 12-E, who provided healthy competition, which inspired the researchers to do better and excel. In addition, they would like to thank their family for their full support and words of encouragement, despite the stressful environment.

Our creator, the Almighty God, made everything possible and became the researchers'



inspiration to continue striving and do better day by day. Hence, the researchers would like to thank Him as well.

Lastly, the researchers would like to acknowledge themselves for pushing through and producing the best paper that they can, despite the sleepless nights and stressful days.

6. REFERENCES

- American Psychological Association. (n.d.). *Intrinsic motivation*. APA Dictionary of Psychology. <https://dictionary.apa.org/intrinsic-motivation>
- Arnaldo, M. S. F. (2020, July 17). *The big boom in baking*. BusinessMirror. <https://businessmirror.com.ph/2020/07/17/the-big-boom-in-baking/>
- Bracale, R., & Vaccaro, C. M. (2020). Changes in food choice following restrictive measures due to Covid-19. *Nutrition, Metabolism & Cardiovascular Diseases*. <https://doi.org/10.1016/j.numecd.2020.05.027>
- Campos, O. V. (2020, April 12). *Flour millers urge consumers to avoid hoarding of bread*. Manila Standard. <https://manilastandard.net/business/biz-plus/321407/flour-millers-urge-consumers-to-avoid-hoarding-of-bread.html#:~:text=Flour%20millers%20on%20Sunday%20called,rest%20of%20the%20buying%20public.>
- Clee, M. A., & Wicklund, R. A. (1980). Consumer Behavior and Psychological Reactance. *Journal of Consumer Research*, 6(4), 389-405. <https://www.jstor.org/stable/2488740>
- Crismundo, K. (2020, August 11). *DTI prepares MSMEs to adopt e-commerce*. Philippine News Agency. <https://www.pna.gov.ph/articles/1111893>
- Dannenberg, P., Fuchs, M., Riedler, T., & Wiedemann, C. (2020). Digital Transition by COVID-19 Pandemic? The German Food Online Retail. *Journal of Economic and Human Geography*, 111(3), 543-560. <https://doi.org/10.1111/tesg.12453>
- Department of Labor and Employment. (2020, April 12). *With extended quarantine Bello to employers: Please pay workers sans job: work displacement breaches 1M mark*. <https://www.dole.gov.ph/news/with-extended-quarantine-bello-to-employers-please-pay-workers-sans-job-work-displacement-breaches-1m-mark/>
- Di Renzo, L., Gualtieri, P., Pivari, F., Soldati, L., Attina, A., Leggeri, C., Caparello, G., Barrea, L., Scerbo, F., Esposito, E., & De Lorenzo, A. (2020). Eating habits and lifestyle changes during COVID-19 lockdown: an Italian survey. *Journal of Translational Medicine*, 18(1), 1-15. <https://doi.org/10.1186/s12967-020-02399-5>
- Easterbrook-Smith, G. (2020). By Bread Alone: Baking as Leisure, Performance, Sustenance, During the COVID-19 Crisis. *Leisure Sciences*, 1-7. <https://doi.org/10.1080/01490400.2020.1773980>
- Gibreel, O., Alotaibi, D. A., & Altmann, J. (2018). Social commerce development in emerging markets. *Electronic Commerce Research and Applications*, 27, 152-162. <https://doi.org/10.1016/j.elerap.2017.12.008>
- Hamdi-Kidar, L. H., & Vellera, C. (2018). Triggers entrepreneurship among creative consumers. *Journal of Business Research*, 92, 465-473. <https://doi.org/10.1016/j.jbusres.2018.07.018>
- Kirk, C. P., & Rifkin, L. S. (2020). I'll trade your diamonds for toilet paper: Consumer reacting, coping, and adapting behaviors in the COVID-19 pandemic. *Journal of Business Research*, 117, 124-131. <https://doi.org/10.1016/j.jbusres.2020.05.028>
- Kuckartz, U. (2019). Qualitative Text Analysis: A Systematic Approach. In G. Kaiser & N. Presmeg (Eds.), *Compendium for early career researchers in Mathematics education* (pp. 181-197). Springer, Cham. https://doi.org/10.1007/978-3-030-15636-7_8
- Laguna, L., Fiszman, S., Puerta, P., Chaya, C., & Tárrega, A. (2020). The impact of COVID-19 lockdown on food priorities. Results from a preliminary study using social media and an online survey with Spanish consumers. *Food Quality and Preference*, 86, 104028. <https://doi.org/10.1016/j.foodqual.2020.104028>
- Navarette, P. (2020, July 6). *Ready, Set, Bake!* Manila Bulletin. <https://mb.com.ph/2020/07/06/ready-set-bake/>
- Nepomuceno, P. (2020, September 1). *Baking helps family survive Covid-19 lockdown*. Philippine News Agency. <https://www.pna.gov.ph/articles/1113965>
- Nistor, A. (2020). The Economic Effects of Social Media in Online Sales. In C. Nastase (vol. ed.), *Lumen Proceedings: Vol. 13. 16th Economic International Conference NCOE 4.0, 2020* (pp. 82-92). Iasi, Romania: LUMEN Publishing House. <https://doi.org/10.18662/lumproc/ncoe4.0.2020/08>
- Ratten, V. (2020). Coronavirus (COVID-19) and entrepreneurship: changing life and work landscape. *Journal of Small Business & Entrepreneurship*, 32(5), 503-516. <https://doi.org/10.1080/08276331.2020.1790167>
- Zhang, Y., Kwark, Y., Wang, Y., & Shin, D. (2020). *Impact of COVID-19 Crisis on Social Commerce: An Empirical Analysis of E-Commerce Social Activities During the Pandemic*. https://papers.ssrn.com/sol3/papers.cfm?abstract_id=3696698



Exploring the Startup Costs and Profit of Bitcoin Mining in Urban Philippines

Enrico Fernando C. Taleon, and Rigil Kent L. Cobrador
San Beda College Alabang, Muntinlupa City

Abstract: Bitcoin and other cryptocurrencies, with their promised easy income scheme, caught the attention of many nations along with the Philippines. The starting price of bitcoin and its profitability differed from nation to nation because of varied electricity costs, internet service providers, and currency value. The study aimed to explore the initial investment and the theoretical expected profit within one year of Bitcoin mining. The researchers used an exploratory research design and data mining techniques to gather quantitative data regarding the specifications of four different ASIC models, Meralco rates from September 2020, and monthly fees from the top three (3) internet service providers in the Philippines. The study did not cover industrial-sized cryptocurrency mining but instead, focused on an independent miner. The study found that theoretically, in one year, none of the ASIC's yielded enough profit to have returned the initial investment. The Philippines' higher than average internet service prices, electrical rates and market competition have jeopardized the profit in bitcoin mining. Hence, individual miners who do not join a mining pool put their investment at risk. A profit may have been established with other cryptocurrencies such as Ethereum or cloud mining. A more sustainable and energy efficient Philippines could be the best answer to the dilemmas one could face with Bitcoin. If one could have easy access to sustainable power sources, a profit could be made stable and predictable.

Key Words: bitcoin; cryptocurrency; ASIC; ISP; NCR

1. INTRODUCTION

Cryptocurrency is defined as digital or virtual currency that is secured by cryptography; hence the name "cryptocurrency" (Frankenfield, 2020). Cryptocurrency is near impossible to counterfeit due to its use of cryptography. This security garnered the interest of many people as outside of being incredibly secure, this also exists outside the control of national governments, and otherwise involved authorities. Before Bitcoin came to life, propositions for digital money were already being proposed and explored. Eventually, Satoshi Nakamoto would create what is known today as Bitcoin (Chohan, 2017). Nakamoto's paper entitled "Bitcoin: A Peer – to – peer Electronic Cash System" explains how the system would work and how transactions would take place.

Ever since Bitcoin was first mined in 2009 (Hong, 2020); it has remained one of the most popular, and most valuable types of cryptocurrency. As more people realize that cryptocurrency can be earned passively and requires an incredibly small effort, people start investing in something called cryptocurrency mining, or more specifically, Bitcoin mining. Kenton (2020), in his article entitled "Bitcoin Mining," defines Bitcoin mining as an action performed by high specification computers to solve complex computation math problems. This means

people can earn money just by setting up computers running Bitcoin mining software.

Though, there is not much recorded history regarding when Bitcoin first reached the Philippines; virtual currency was officially acknowledged by the Banko Sentral ng Pilipinas in Circular 944, series of 2017. The circular defined cryptocurrency in the Philippines and included requirements and guidelines regarding the use of cryptocurrency. With cryptocurrencies being acknowledged and legalized, many Filipino citizens have taken an interest in cryptocurrency mining. The issue being encountered from the rise of popularity in Bitcoin is that people start investing into it without understanding its financial implications and its risks from mining. It is common to find articles and videos about Bitcoin, but these sources may only convince people to invest in sub-standard equipment. In this study, the researchers will explore the startup costs and profits of Bitcoin mining in urban Philippines. It highlights the profitability of personal Bitcoin mining in the Philippines, extending to its potential risks. Furthermore, the study also aims to fill the research gap regarding Bitcoin and other cryptocurrency mining in smaller countries like the Philippines.



2. METHODOLOGY

In order to explore the costs of Bitcoin mining in the Philippines, the researchers used an exploratory research design and data mining techniques that gathered quantitative data regarding the prices of ASIC's, electrical rates, and the monthly rates from the top three (3) internet service providers (ISP) in the Philippines. The data for the ASIC's were taken from their respective seller sites, electrical rates for September 2020 were taken from Meralco's monthly breakdown, and the ISP prices were taken from an article by Pineda, (2020). Four different ASICs from different brands were considered: The Antminer S19 Pro, the EBIT E12+, the M40 410 TH/S Whatsminer, and the Strongu STU 8. The numerical data was gathered by the researchers without any intervention and manipulation in prices besides the conversion of dollar into peso.

Through classification of bitcoin startup costs and the materials to invest in, the researchers were able to predict if a miner, without joining any mining pools or organization, would profit in one year. The prediction of the possible profit in bitcoin mining and the risks one may have encounter was reflected in the various price list collected in major bitcoin sites and shops in urban Philippines.

The figure 1 below discussed the process of the data mining utilized in the study. All of the startup costs data was based on online references that classify the price of the ISP, identify the different ASIC prices and determine the USD conversion to PHP. These data were significant in the analyses of the inferred profit one may have gained in bitcoin mining investment. The simple calculation of profit was based on a generic mathematical computation published in an online article by Byju's (2019).

Figure 1
Research Process Flowchart

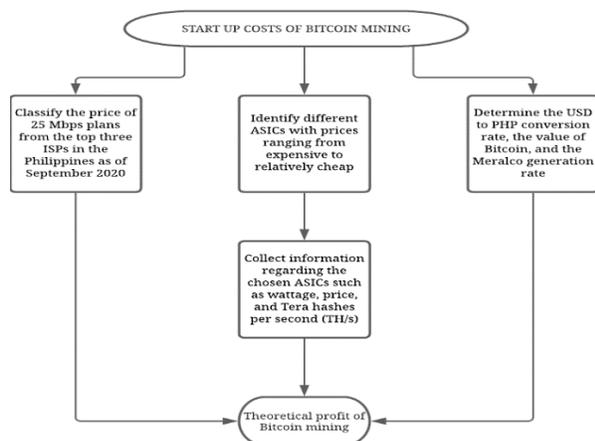

Note. The theoretical profit of Bitcoin mining was calculated by deducting the total gained to total spent, whereas, total spent was calculated by the summation of ASIC price to energy cost.

3. RESULTS AND DISCUSSION

Table 1
Initial Purchase Price of an ASIC

ASIC Model	Price in Dollar	Price in Peso
<i>M40 410^{TH/S} WHATSMINER</i>	3,999.00	194,071.47
<i>ANTMINER S19 PRO</i>	2,387.00	115,841.11
<i>STRONGU STU 8</i>	<i>1,615.00</i>	78,375.95
<i>EBIT E12+</i>	<i>1,500.00</i>	72,795.00

Note. Conversion rate was adapted from X-Rates, <https://www.x-rates.com/average/?from=USD&to=PHP&amount=1&year=2020>. The conversion was based from September 2020 rates of USD to PHP.

Table one discussed the initial purchase price of the four ASIC's considered in the study. It was necessary to convert each ASIC price to Philippine Peso using standard rates before considering purchase value because certain websites and sellers were permanently set in a specific currency. Thus, if one purchased from a site using a credit or debit card set in a different currency type, they would be paying a greater or lesser value than what was indicated on the shop due to currency conversion, (Saccomanno, 2019).

Table 2
Energy and Generation Costs

ASIC Model	ASIC-Specific Energy Usage		Yearly	
	Wattage	kWh	Consumption	Generation Cost
<i>M40 410^{TH/S} WHATSMINER</i>	2570	2.57	22,513.20	91,988.94
<i>ANTMINER S19 PRO</i>	3250	3.25	28,470.00	116,328.42
<i>STRONGU STU 8</i>	<i>2100</i>	2.10	18,396.00	75,166.06
<i>EBIT E12+</i>	<i>2500</i>	2.50	21,900.00	89,483.40



Note. Generation cost was retrieved from MERALCO generation rates of September 2020. Generation Cost was in Philippine Peso. Generation cost was calculated by multiplying consumption by 4.09. Yearly energy consumption was calculated by multiplying the kWh by 8,760, the number of hours in a calendar year.

Among the ASIC's, the Antminer model was found to have the highest generation costs while the Strongu model has the lowest. Fantazzini and Kolodin (2020) discussed that an ASIC with fair generation cost must be considered by a miner for it would affect the capability of profit drastically because of its maintenance fees and other operational expenses. Generation costs wise, it was best to use the Strongu model.

Table 3
Internet Charges

Internet Service Provider	Cost of 25 Mbps Plan	
	Monthly (Base)	Yearly
<i>Converge ICT Solutions</i>	1,500.00	18,000.00
<i>ONE SKY (Sky Fiber)</i>	1,499.00	17,988.00
PLDT	1,699.00	20,388.00

Note. Retrieved from Best DSL & Fiber Internet Broadband Providers & Plans in the Philippines by A. Pineda (2020). Prices were in Philippine Peso. Yearly costs were computed by multiplying monthly price by 12.

The 25 Mbps plan was considered standard for Bitcoin mining because this speed could already support most online activities, such as HD streaming, simultaneous browsing, downloading, and uploading. (Anders, 2020). This was further discussed in an online article by InternetAdvisor in 2020 that a 25 Mbps plan would be enough for Bitcoin mining. Internet stability was more important than internet speed, hence, internet speed was only needed for data syncing. Assuming that all three internet service providers were of equal caliber and offer a consistent internet connection, using ONE SKY would be the best way to make a profit because it is the cheapest among the three.

Table 4
Expenditures in One Year

Expenditure Type	ASIC				
	<i>MAO WHATSMIN ER</i>	<i>410^{THS} ANTMIN ER S19 PRO</i>	<i>STRONG U STU 8</i>	<i>EBIT E12+</i>	
<i>Initial Price</i>	194,071.47	115,841.11	78,375.95	72,795.00	
<i>Energy Cost for 1 Year</i>	91,988.94	116,328.42	75,166.06	89,483.40	
Total	286,060.41	232,169.53	153,542.01	162,278.40	

Table 4
Continued

Internet Service Provider	Total Expenditure in One Year				
	<i>MAO WHATSMIN ER</i>	<i>410^{THS} ANTMIN ER S19 PRO</i>	<i>STRONG U STU 8</i>	<i>EBIT E12+</i>	
<i>Converge ICT Solutions</i>	304,060.41	250,169.53	171,542.01	180,278.40	
<i>ONE SKY (Sky Fiber)</i>	304,048.41	250,157.53	171,530.01	180,266.40	
PLDT	306,448.41	252,557.53	173,930.01	182,666.40	

Note. Prices were in Philippine Peso. There were three (3) different total expenditures in one year depending on what ISP was considered. Values were computed using the values from tables 1, 2, and 3.

It was apparent from the table that it was very expensive to invest in Bitcoin mining even for just a year. With this high cost, Bitcoin mining was not just a small-time investment and it required a resourceful and constant attitude to profit from it. Hogan (2020) emphasized that in Bitcoin mining, the get-rich-quick schemes were to good to be true, whereas, the road for Bitcoin investments can be rough and risky.



Table 5
Estimated Amount Mined and Profit in a Year of Mining

ASIC Model	Hash (TH/s)	Rate	Equivalent Peso Mined Per Year	
<i>M40 410^{TH/S} WHATSMINER</i>	410		279,637.62	
<i>ANTMINER S19 PRO</i>	110		75,024.95	
<i>STRONGU STU 8</i>	46		31,859.46	
<i>EBIT E12+</i>	50		34,102.03	
Profit in a Year of Mining				
Internet Service Provider	<i>M40 410^{TH/S} WHATSMI NER</i>	<i>ANTMI NER S19 PRO</i>	<i>STRON GU STU 8</i>	<i>EBIT E12+</i>
<i>Converge ICT Solutions</i>	-24,422.79	- 175,144. 58	- 139,682 .55	- 146,17 6.37
<i>ONE SKY (Sky Fiber)</i>	-24,410.79	- 175,132. 58	- 139,670 .55	- 146,16 4.37
PLDT	-26,810.79	- 177,532. 58	- 142,070 .55	- 148,56 4.37

Note. The value of Bitcoin was retrieved from YCharts (2020). All values were in Philippine Peso. The value of one Bitcoin considered was 10,622.79. Negative values signified a loss instead of a profit.

The losses in one year would be large among the listed ASICs except for the Whatsminer which would be close to being able to at least break even. This showed that theoretically, no matter what ASIC or ISP one might use, there was little to no profit expected after one year. The reasoning behind this was because of the inability of the Philippines to compete with giants such as China and Iceland whose computing power was much greater among developing countries, (Adalbjornsson, 2019). Energy in the Philippines was one of the most expensive in Asia, in which an article by Uy (2018) was cited; the maintenance fees became too high to make a profit. When compared to the aforementioned Cryptocurrency giants who have access to cheaper electricity and were also able to efficiently use secondary power sources such as hydropower and geothermal power. Bitcoin miners in the Philippines would be hemorrhaging a lot of their potential profit just to pay for the bills according to Padilla (2020),

through personal communication with the researchers.

4. CONCLUSION AND RECOMMENDATION

The exploration of the startup costs and profit of bitcoin mining in urban Philippines suggested that theoretically, the costs of investment in Bitcoin mining would require big monetary values and could be risky because none of the four identified ASIC's were able to profit after one year in the Philippines, regardless of the ISP used. Even the M40 410 TH/s WhatsMiner, the most expensive and efficient unit considered in this study, was unable to output a profit. The researchers have speculated that the inability of the four ASICs to profit in the Philippines was due to the expensive electricity costs of the country compared to other nations. Hence, the researchers concluded that the expensive startup costs would have generated no profit in personal bitcoin mining in the urban Philippines.

Bitcoin mining in the Philippines could not be recommended for an individual who do not have the monetary capacity, resourcefulness, and social network because the electricity costs, maintenance costs and other operational expenses of running an ASIC in the country would not guarantee a profit. The researchers would have suggested other types of mining cryptocurrency or trading, whereas a miner would be able to profit if they could have ventured to other cryptocurrencies such as Ethereum or with cloud mining. Careful decision making for this kind of service should be applied because many cloud mining services are not registered under the Security and Exchange commission and are considered illegal.

Lastly, a more sustainable and energy efficient Philippines could be the answer to the dilemmas one could face with Bitcoin. If a starting individual or a large-scale cryptocurrency miner could have an easy access to sustainable power sources such as geothermal energy, wind energy and solar energy, a profit could be made stable and predictable, boosting the country's economic prosperity.

5. ACKNOWLEDGEMENTS

First and foremost, our deepest gratitude goes to Mr. Dominador Callo Jr, LPT for acting as our research advisor. Without his insight, guidance, feedback, and assistance; none of this would be possible.

We are grateful to the San Beda College Alabang Principal, Dr. Jeana A. Ariola and STEM Faculty for their guidance throughout the whole research procedure.



Our appreciation also extends to our colleagues and advisors, specifically Mr. Marvin Vivar, from the Bedan Mathematics and Sciences Circle for allowing us the opportunity to represent the school as part of the academic community.

Lastly, we would like to thank our family and friends for their continuous and unending support through all our endeavors.

6. REFERENCES

Sbtc, & Ogundeji, O. (2019, August 2). 85 Percent of Bitcoin Has Been Mined. Implications? Bitcoin Magazine. <https://bitcoinmagazine.com/articles/implications-for-bitcoin-now-that-85-percent-of-supply-has-been-mined>

Adalbjornsson, T. (2019). Iceland's data centers are booming—here's why that's a problem. <https://www.technologyreview.com/2019/06/18/134902/icelands-data-centers-are-booming-heres-why-thats-a-problem/>

Anders, D. (2020). Internet speed classifications: What's fast, what's slow and what's a good internet speed? <https://www.allconnect.com/blog/internet-speed-classifications-what-is-fastinternet#:~:text=speeds%20seem%20slow.,What%20is%20a%20good%20internet%20speed%3F,web%20browsing%20and%20downloading%20music.>

BitcoinCore. (2020). Requirements and Warnings - Bitcoin Core. Bitcoin.org. https://bitcoin.org/en/bitcoincore/features/requirements?fbclid=IwAR01kFJJCM9wYbQSQSBL0MZZTnq_INFR05i-feu4kE0fkg15a8yTDLTI

Bitmain. (2020). Bitmain. Bitmain.com. https://shop.bitmain.com/promote/antminer_s9i_asic_bitcoin_miner/specification

Buy Bitcoin Worldwide. (2020). Bitcoin Mining Profit Calculator (Updated). <https://www.buybitcoinworldwide.com/mining/calculator/>

Byju's. (2019, February 28). Profit Formula - Profit Percentage Formula and Gross Profit Formula. BYJUS; BYJU'S. <https://byjus.com/profit-formula/>

Chiu, J., & Koeppl, T. V. (2017). The Economics of Cryptocurrencies Bitcoin and Beyond. SSRN Electronic Journal. <https://doi.org/10.2139/ssrn.3048124>

Chohan, U. W. (2017). A History of Bitcoin. SSRN Electronic Journal. <https://doi.org/10.2139/ssrn.3047875>

Creasy, J. (2017, August 29). The Top 10 Mistakes Crypto Newcomers Make - BlockChannel - Medium. Medium; BlockChannel. <https://medium.com/blockchannel/the-top-10-mistakes-crypto-newcomers-make-d3b75203dd6f>

Fantazzini, D. & Kolodin, K. (2020). Does the Hashrate Affect the Bitcoin Price? <https://doi:10.3390/jrfm13110263>

Fortney, L. (2020). Bitcoin Mining Definition. Investopedia. <https://www.investopedia.com/terms/b/bitcoin-mining.asp>

Frankenfield, J. (2020a). Cloud Mining. Investopedia. <https://www.investopedia.com/terms/c/cloud-mining.asp>

Frankenfield, J. (2020b). Cryptocurrency. Investopedia. <https://www.investopedia.com/terms/c/cryptocurrency.asp>

Frankenfield, J. (2020c). Mining Pool Definition. Investopedia. <https://www.investopedia.com/terms/m/mining-pool.asp>

Fuller, A. (2017, December 5). Bitcoin mining - can it be profitable? | Finder Philippines. Finder Philippines; finder. <https://www.finder.com/ph/bitcoin-mining>

Hay, S. (2019, July 11). 5 Most Important Cryptocurrencies (Besides Bitcoin) - Coinmama. <https://www.coinmama.com/blog/5-most-important-cryptocurrencies-besides-bitcoin/>

Helms, K. (2020, July 23). Philippines Now Has 16 Cryptocurrency Exchanges Approved by Central Bank | Exchanges Bitcoin News. Bitcoin News. <https://news.bitcoin.com/philippines-16-cryptocurrency-exchanges-approved-central-bank/>

Hogan, C. (2020). 4 Things to Know Before Investing in Cryptocurrency <https://www.chrishogan360.com/investing/investing-in-cryptocurrency>

Hong, E. (2020). How Does Bitcoin Mining Work? Investopedia. [https://www.investopedia.com/tech/how-does-bitcoin-mining-work#:~:text=As%20of%20the%20time%20of,9%2C300\)%20for%20completing%20a%20block.](https://www.investopedia.com/tech/how-does-bitcoin-mining-work#:~:text=As%20of%20the%20time%20of,9%2C300)%20for%20completing%20a%20block.)

InternetAdvisor. (2020). How Much Internet Speed Do You Need To Mine Bitcoin? InternetAdvisor.com. <https://www.internetadvisor.com/how-much-internet-speed-do-you-need-to-mine-bitcoin#:~:text=There%20have%20been%20instances%20in,need%20more%20than%2015%20Mbps.>

Karamat, S. (2018). What is Hash Rate? Coin Rivet. <https://coinrivet.com/guides/what-is-cryptocurrency-mining/what-is-hash-rate/>

Meralco. (2020). BREAKDOWN OF GENERATION CHARGE. https://meralcomain.s3.ap-southeast-1.amazonaws.com/2020-09/09-2020_gc_table.pdf

Murray, M. (2018, January 2). Mining Bitcoin with a GPU in 2018 - The Geek Pub. The Geek Pub. <https://www.thegeekpub.com/11407/mining-bitcoin-gpu-2018/>

Nakamoto, S. (2008). Bitcoin: A Peer-to-Peer Electronic Cash System. <https://bitcoin.org/bitcoin.pdf>

Paul, J. (2020). Lowering The Electricity Costs Of Mining Bitcoin [A How-To Guide] | Hacker Noon. Hackernoon.com. <https://hackernoon.com/lowering-the-electricity-costs-of-mining-bitcoin-a-how-to-guide-0o7732s4>

Pineda, A. (2020, September 22). Best DSL & Fiber Internet Broadband Providers & Plans in the Philippines. Grit PH; Grit PH. <https://grit.ph/internet-plans/>

Redman, J. (2019, May 31). Bitcoin Mining With Solar: Less Risky and More Profitable Than Selling to the Grid | Mining Bitcoin News. Bitcoin News. <https://news.bitcoin.com/bitcoin-mining-with-solar-is-less-risky-and-more-profitable-than-selling-to-the-grid/>

Riddett, J. (2020, May 17). Do You Need A Fast Internet Connection To Mine Cryptocurrency? - Easy Crypto Hunter. Easy Crypto Hunter. <https://easycrypto.codegalaxy.co.uk/do-you-need-a-fast-internet-connection-to-mine-cryptocurrency/>

Saccomanno, S. (2019, August 8). The Importance of Integrated Currency Conversion - The Startup - Medium. Medium; The Startup. <https://medium.com/swlh/the-importance-of-integrated-currency-conversion-bed96be1da4e>

Securities and Exchange Commission Philippines. (2018, April 10). Advisory on Cloud Mining Contracts - Securities and Exchange Commission. <https://www.sec.gov.ph/advisories-2018/advisory-on-cloud-mining-contracts/>

Security and Exchange Commission Philippines. (2018, August 2). SEC RELEASES PROPOSED RULES ON INITIAL COIN OFFERINGS. <http://www.sec.gov.ph/https://perma.cc/A3BQ-SZ8H>

Senfuma, S. (2017). » Cryptocurrencies – Pros, Cons, Feasibility and Regulation. Atlascorp.org. <https://atlascorp.org/cryptocurrencies-pros-cons-feasibility-regulation/>

Sharma, R. (2020). Do Bitcoin Mining Energy Costs Influence Its Price? Investopedia. <https://www.investopedia.com/news/do-bitcoin-mining-energy-costs-influence-its-price/>

Uy, F. (2016). Energy Pricing in the Philippines and its Effect on Economic Growth. <https://academiccommons.columbia.edu/doi/10.7916/D8NP2C4X/download>

Walton, J. (2017, December 14). What you need to know about cryptocurrency mining. Pcgamer; PC Gamer. <https://www.pcgamer.com/what-you-need-to-know-about-cryptocurrency-mining/>

Weiss, R. (2019). How much electricity (kWh) does an Antminer S9 consume in a day? - Quora. Quora.com. <https://www.quora.com/How-much-electricity-kWh-does-an-Antminer-S9-consume-in-a-day#:~:text=rate%2C%20etc.,Based%20upon%20our%20experiences%2C%20on%20average%2C%20Antminer%20S9s%20actually%20draw,will%20draw%20about%201%2C080%20kWh.>

X-Rates. (2020a). Exchange Rate Average (US Dollar, Philippine Peso) - X-Rates. <https://www.xrates.com/average/?from=USD&to=PHP&amount=1&year=2020>

X-Rates. (2020b). Exchange Rates Graph (US Dollar, Philippine Peso) - X-Rates. <https://www.x-rates.com/graph/?from=USD&to=PHP&amount=1>

YCharts. (2020). Bitcoin Price. Ycharts.com; YCharts. https://ycharts.com/indicators/bitcoin_price

Zhu, N., & Yan, M. (2019). Feasibility Analysis of Digital Currency Market - Taking Bitcoin as an Example. In Research Gate. https://www.researchgate.net/publication/333721586_Feasibility_Analysis_of_Digital_Currency_Market_-_Taking_Bitcoin_as_an_Example



Karanasan ng mga Piling Negosyante ng Produktong Damit Pambabae sa Paggamit ng Estratehiyang Green Marketing

Camille Victoria G. Jaurigue
Assumption College, Makati

Abstrak: Ang pag-aaral na ito ay naglalayong masuri ang karanasan ng mga negosyante na nagbebenta ng produktong damit pambabae na gumagamit ng estratehiyang green marketing. Ang instrumentong ginamit sa pangangalap ng datos ay Patnubay na Talatanungan na may labing pitong tanong tungkol sa mga temang green design, green pricing, at green disposal. May walong (8) kalahok na negosyante ng damit galing sa Metro Manila na pinili gamit ang purposive sampling teknik. Isinagawa ang pangangalap ng datos simula sa pagbubuo ng gabay na tanong pagkatapos ay ipinakita at inaprubahan ng dalubguro bago ito ipinadala sa e-mail ng mga tinarang na kalahok hanggang sa isagawa ang video call sa napagkasunduang petsa at oras. Nakita sa isinagawang pananaliksik na ang mga negosyanteng ay gumagamit ng green design sa paraan ng paggamit ng mga sustainable fibers, at ito ay nakakatulong sa kalikasan dahil sa paggamit ng mga natural na mapagkukunan. Lumitaw rin na ginagamit ang green pricing sa paraan ng pagpepresyo ayon sa kanilang gastos. Sa huli, nakita sa pananaliksik na papel na ang paggamit ng mga negosyante sa green disposal ay sa paraan ng pagdo-donate o pagre-recycle ng kanilang retaso at iba pang basura. Sa ganitong paraan nakatutulong sa pagliligtas ng kalikasan. Nirekomenda ng mananaliksik sa mga grupo na maaaring magsagawa ng pag-aaral na gaya nito na mas mapalawig pa ang kaalaman tungkol dito at sa iba pang mga negosyante ng damit pambabae na makita nila ang kahalagahan ng pagsuporta sa green marketing at ang epekto nito sa kinabukasan ng kalikasan ng mundo.

Key Words: green marketing; green design; green pricing; green disposal

1. INTRODUKSIYON

Tumataas ang pagdami ng mga negosyo na sumusunod sa estratehiyang *Green Marketing*. Ayon sa artikulo na isinulat nina Arseculeratne at Yazdanifard (2014), ang ideya ng *Green Marketing* ay umiikot sa pagiging makalikasan ng mga negosyo. Kinakailangan ang pag-aaral na ito upang magkaroon ng mas malalim na pag-unawa tungkol sa mga estratehiya na ginagamit ng mga negosyante na nagbebenta ng damit pambabae sa *Green Marketing*. Base kina Workman at Lee (2011), ang mga babae ang kasangkot sa pamimili ng mga damit sa industriya ng *fashion*. Ayon sa pag-aaral nina Mishra at Sharma (2010) nagbigay ng oportunidad at hamon ang paggamit ng *Green Marketing* sa India. Gayundin ang pag-aaral na isinulat nina Cherian at Jacob (2012), tungkol naman sa mga saloobin ng mga mamimili sa mga produktong gumagamit ng *Green Marketing*. Dahil sa mga pag-aaral na ito, nakita ang kakulangan sa pag-aaral ng mga negosyante sa damit pambabae sa Pilipinas. Base sa isang artikulo na isinulat nina Bick, Halsey, at Ekenga (2018), limang porsyento (5%) ng tambakan ng basura ay puno ng mga damit na tinapon lamang. Mahalaga na malaman ng mga negosyante ang mga posibleng

paraan sa pagnenegosyo na makabubuti sa kalikasan.

2. KAUGNAY NA LITERATURA AT PAG-AARAL

Mas lalong magiging malinaw ang pagkakaunawa sa pag-aaral at pagsisiyasat sa paksang sinasaliksik dahil matutunghayan sa bahaging ito ang mga kaugnayan na pag-aaral at literatura na ginagamit ng mananaliksik.

Green Marketing

Ayon sa isang artikulo mula kay Sarkar (2012), ang *green marketing* ay tumutukoy sa pagtaguyod ng mga produktong makalikasan. Dahil dito, mas pinipili ng maraming mamimili sa mga negosyo na gumagamit ng *green marketing*. Bukod pa rito, ayon kay Bukhari (2011), mayroong ebidensya na nagpapahiwatig na nagbabago ang kaugalian ng mga tao dahil sa kanilang pagmamalasakit sa kalikasan.

Damit Pambabae

Ang disenyo ng mga damit na gumagamit ng *green marketing* ay nakadugtong sa makalikasan na pagsasanay ng negosyo (Kim & Hall, 2015). Bagaman, ayon kina Cervellon at Carey (2011), mayroong tatlong grupo ng mga mamimili tungkol sa kanilang



mga motibasyon at mga inaasahan sa mga *green fashion at beauty products*:

1. *Health benefits, 'health-conscious consumers'*
2. *Environmentalists*
3. *Quality hunters*

Samakatuwid, mas nagkaroon ng kamalayan ang mga mamimili tungkol sa mga problemang nararanasan ng kalikasan, at dahil dito, mas pinipili nila ang pagbabawas ng basura sa mundo at ang pagsuporta ng mga *green* na negosyo (Cherian & Jacob, 2012).

Paraan ng Paggamit

Ang unang uri ng *green marketing* ay ang *green design*, ayon kay Koszewska (2015) na inayunan nina Thilak & Saravanan (2015), mahalaga na sumunod ang mga negosyo na nagbebenta ng mga damit ang pagpapanatili ng prinsipyo ng disenyo (*sustainable design principles*). Ilan sa mga nabanggit na halimbawa ay ang paggamit ng "*sustainable fibers, low-impact materials*, at marami pang iba. Dahil sa *green design* nakikinabang dito ang kalikasan. Ayon kay Kumar (2017), ang "*ecological organic cotton, bamboo fiber, color natural silk, at corn fiber*" ay ilan sa mga hinabi na ginagamit ngayon sa mga makalikasan na negosyo.

Ang pangalawang uri ng *green marketing* ay ang *green pricing*. Ito ay ang pagpre-presyo ng mga produkto (Sohail, 2017). Ngunit, ayon kay Epstein (2018), naaapektuhan rin ang mga presyo ng mga produkto at serbisyo na umaasa sa enerhiya, dahil sa pagkontrol ng *greenhouse gases*. Ayon kay Yenipazarli at Vakharia (2015), kahit anong stratehiya ng pagpepresyo ang gagamitin ng isang negosyo, may ugali ang mga mamimili na pipiliin nila ang mga *green* na produkto liban sa mga produkto na hindi nakakatulong sa kalikasan.

Ang huli ay ang *green disposal*. Maaaring mabawasan ang gastos ng mga negosyo dahil sa pagbabawas ng nakakapinsala na pagtatapon (Saini, 2013). Ayon kina Bianchi at Birtwistle (2010), ang kamalayan ng mga mamimili tungo sa mga problemang nararanasan ng kalikasan ay dahil sa pagkakaroon ng mga donasyon ng damit at pagbebenta ng *second-hand* na damit, maliban sa mga naitatapon.

3. KONSEPTWAL NA BALANGKAS

Nagsimula ang balangkas sa estratehiya ng *Green Marketing*. Sa ilalim nito bibigyang pokus ang kasuotang pambabae at sa ilalim ng kasuotang pambabae ang tatlong paksang tatalakayin sa estratehiya ng *Green Marketing*, ang *Green Design*, ang *Green Pricing*, at ang huling bahagi ay ang *Green Disposal*.

4. MGA LAYUNIN NG PAG-AARAL

Ang pananaliksik na ito ay nakatuon sa karanasan ng mga piling negosyante ng produktong damit pambabae sa paggamit ng estratehiyang *Green Marketing*.

Nais ng mga mananaliksik na masagot ang mga sumusunod na katanungan:

1. Ano ang mga karanasan ng mga piling negosyante ng produktong damit pambabae sa paraang *green design* ng estratehiyang *Green Marketing*?
2. Ano ang mga karanasan ng mga piling negosyante ng produktong damit pambabae sa paraang *green pricing* ng estratehiyang *Green Marketing*?
3. Ano ang mga karanasan ng mga piling negosyante ng produktong damit pambabae sa paraang *green disposal* ng estratehiyang *Green Marketing*?

5. SAKLAW AT LIMITASYON

Sakop ng pananaliksik na ito ang mga karanasan ng mga piling negosyante ng damit pambabae sa paggamit ng estratehiyang *Green Marketing*. Ngunit, ang pokus lamang ng mananaliksik ay ang *Green Design, Green Pricing, at Green Disposal*. Nilimitahan ng mananaliksik ang pag-aaral na ito sa mga negosyanteng gumagamit ng estratehiyang *Green Marketing* na nasa Metro Manila lamang. Walang naganap na paglilimita sa edad ng mga piling negosyante basta't sila ay gumagamit ng mga estratehiyang *Green Marketing*.

6. KAHALAGAHAN NG PAG-AARAL

Ang pananaliksik na ito ay magsisilbing tulong para sa mga negosyante na hindi pa gumagamit ng mga estratehiyang *Green Marketing*.

Kaya mahalaga ang pag-aaral na ito sa mga sumusunod:

Mga negosyante na hindi gumagamit ng *Green Marketing*. Upang malaman ang mga karanasan ng mga piling negosyante sa paggamit ng mga estratehiya ng *Green Marketing: Green Design, Green Pricing, at Green Disposal*.

Mga mamimili na bumibili ng damit pambabae. Upang malaman ng mga mamimili ang tunay na kahalagahan at ang mga dahilan kung bakit gumagamit ang mga negosyo ng mga estratehiyang *Green Marketing*.

Mga negosyante na gumagamit ng *Green Marketing*. Upang malaman ng mga negosyante ang mga



karanasan ng mga piling negosyante sa paggamit nila sa mga estratehiyang *Green Marketing*.

7. METODOLOHIYA

Tatalakayin sa kabanatang ito ang disenyo ng pananaliksik na ginagamit gayundin ang pamantayan sa pagpili sa mga kalahok, ang mga instrumentong ginamit at mga hakbang na isinasagawa ng mga mananaliksik upang makakalap ng mga datos at ang paraan ng pagsusuri ng datos.

Disenyo ng Pananaliksik

Ang pag-aaral na ito ay tungkol sa karanasan ng mga piling negosyante ng produktong damit pambabae sa paggamit ng estratehiyang *Green Marketing*. Ito ay isasagawa gamit ang penomenolohikal na disenyo. Tatangkain nitong ilarawan ang pag-uugali ng mga piling negosyante sa paggamit ng estratehiya ng *Green Marketing*.

Mga Respondente at Sampling Teknik

Ang mga kalahok ay binubuo ng walong respondente na pawang mga babae na nasa pangkat ng mga *Millenials*. Sila ay pinili mula sa mga negosyante na gumagamit ng mga estratehiyang *Green Marketing* ng Metro Manila. Pipiliin ang mga kalahok gamit ang *purposive sampling* teknik. Kinakailangan na ang mga kalahok ay gumagamit ng mga estratehiyang *Green Marketing*

Instrumento ng Pag-aaral

Ang instrumento ng pananaliksik na ginamit sa pangangalap ng mga datos ay ang Patnubay na Talatanungan. Mayroong tatlong (3) tiyak na layunin na nais masagot ng mananaliksik. Ang unang anim na tanong ay sasagot sa unang tiyak na layunin tungkol sa *green design*, ang susunod na anim na tanong naman ay tungkol sa pangalawang tiyak na layunin tungkol sa *green pricing*, at ang huling limang tanong ay sasagot sa pangatlong tiyak na layunin tungkol sa *green disposal*.

Paraan ng Pagkalap ng mga Datos

Ang mga sumusunod na hakbang ang isinagawa ng mga mananaliksik upang matiyak na maayos at sistematiko ang pagkalap ng mga datos.

Nag-umpisa ang mananaliksik sa pagbuo ng gabay na tanong na gagamitin para sa interbyu na magsisilbing instrumento sa pangangalap ng datos. Ipinakita at ipinaaprobahan ito sa dalubguro na si: Gng. Imelda E. Bitancor. Inedit at nirebisa ang gabay na tanong para sa interbyu ayon sa mga komento at mungkahi ng mga dalubguro. Bumuo ng Liham ng Pahintulot na ibinigay gamit ang *e-mail* o *private message*. Matapos maaprobahan ng guro ay agad na nagpaskedyul ng oras at araw ng pakikipanayam o interbyu. Ang aktwal na interbyu ay ginanap noong

Marso 16 hanggang Marso 22, sa paraan ng pagtawag o *video call*. Matapos maisagawa ang interbyu ay agad na binuo ang transkripsyon ng pakikipanayam sa bawat respondente.

Pagsusuri ng mga Datos

Mula sa isinagawang pakikipanayam, sinuri ng mananaliksik ang mga sagot ng mga respondenteng negosyante na gumagamit ng *Green Marketing* batay sa mga nangingibabaw na tema.

8. RESULTA

Batay sa makikita sa unang talahanayan, ang mga karanasan ng mga piling negosyante sa produktong damit pambabae sa paggamit ng green design ay pinangunahan ng hindi pa paggamit ng renewable energy sa mga negosyo. Sapagkat, inaalagaan nila ang enerhiya na ginagamit nila sa produksyon ng kanilang mga produkto. Bukod pa rito, ginagamit rin nila ang mga sustainable fibers sa mga disenyo ng kanilang mga produkto. Gumagamit sila ng mga tela tulad ng linen at katsa, sapagkat ang ilan sa mga respondente ang nagsabi na sila ay gumagamit ng mga luma o retasong tela na maaari pang mapakinabangan upang maiwasan ang pagdami ng dumi sa paligid.

Talahanayan 1. Karanasan ng mga piling negosyante ng produktong damit pambabae sa paraang *green design* ng estratehiyang *Green Marketing*

Tema	f	Verbatim
<i>Renewable Energy</i>	8	“Well, right now we don’t really use any renewable energy, but what we do is that we try to avoid energy consumption.”
<i>Sustianable fibers</i>	6	“...we use uh all natural fabrics. Uh when I say all-natural, that means it’s biodegradable.”

Note. n=8 piling negosyante; para sa tanong 1, 2, 4, 6, 10

Batay naman sa makikita sa talahanayan 2, ang mga karanasan ng mga piling negosyante sa paggamit ng green pricing na ang pinagbasihan ay ang gastusin ng mga negosyante tulad ng gastos ng mga materyales, suweldo ng mga manggagawa, at presyo ng kanilang kakumpitensya. Gayunpaman, tinitignan ng mga negosyante ang kakayahan ng kanilang mga mamimili. Gusto ng mga negosyante na ang presyo ng kanilang mga produkto ay kayang bilhin ng kanilang mga mamimili. Bukod pa rito, positibong nakakaapekto ang *packaging* na ginagamit sa negosyo, ang mga materyales nito ay mga ni-recycle



lamang at mga murang materyales na hindi gaano nakakaapekto sa mga presyo ng kanilang produkto.

Talahanayan 2. Karanasan ng mga piling negosyante ng produktong damit pambabae sa paraang *green pricing* ng estratehiyang *Green Marketing*

Tema	f	Verbatim
<i>Gastusin</i>	5	"...so there are cost of um goods or cost of manufacturing, cost of labor, cost of fabrics, marketing, advertising..."
<i>Kakayahan</i>	4	"...the main rule that we had when deciding our prices was that it had to be affordable..."
<i>Packaging</i>	3	"we just use recycled materials so there's no cost."

Note. n=8 piling negosyante; para sa tanong 6, 7, 8, 9

At para sa huling talahanayan, ang mga karanasan ng mga piling negosyante sa paggamit ng *green disposal* ay mahalaga para sa kalikasan ng mundo. Ito rin ay nakakatulong sa pagtataguyod ng mga negosyo na may layunin na makatulong sa kalikasan. Bukod pa rito, nakikita sa *green disposal* ang pag-recycle ng basura. Ang mga retaso na tela at iba pang mga materyales ay ginagamit para sa mga bagong produkto, dahil may mga negosyante na nagdo-donate rin ng kanilang mga retasong tela na kinakailangan ng ibang grupo.

Talahanayan 3. Karanasan ng mga piling negosyante ng produktong damit pambabae sa paraang *green disposal* ng estratehiyang *Green Marketing*

Tema	f	Verbatim
Kahalagahan	8	"...we do our part as good stewards of this world um good role models and a positive example to the next generations,"
Donasyon	4	"um donate them to small cooperatives that make rags ..."

KABANATA 4

Diskusyon

Tatalakayin ng mananaliksik sa kabanatang ito ang lagom ng mga resulta, implikasyon, limitasyon, gayundin ang rekomendasyon para sa

mga susunod pang mananaliksik na may interes sa paksang pinag-aaralan.

9. LAGOM

Matapos masuri at mailahad ang resulta, natuklasan ng mananaliksik ang mga sumusunod:

1. Ang *green design* ng estratehiyang *Green Marketing* ay gumagamit ng *sustainable fibers, recyclable packaging o packaging* na makalikasan, at gumagamit ng *renewable energy*.
2. Ang *green pricing* ng estratehiyang *Green Marketing* ay binabase ang presyo ayon sa gastos ng negosyo, at ang *packaging* na ginagamit nila.
3. Ang *green disposal* ng estratehiyang *Green Marketing* ay sa paraan ng *pagre-recycle* ng basura, *pag-donate* ng basura, at sa pagsusulong sa kanilang mga mamimili tungkol sa kahalagahan ng *green disposal*.

Ipinapakita sa resulta na isang paraan ng paggamit ng *green design* na ginagamit ng mga negosyante ay ang paggamit ng mga *sustainable fibers*. Ayon kina Niinimaki at Hassi (2011), ang paggamit ng makalikasan na tela sa industriya ng damit ay nag-aambag ng magandang epekto sa kalikasan, ngunit ito ay hindi nagpapakita ng malaking pagbabago dahil hindi pa handa ang lahat ng negosyo sa paglipat sa paggamit ng mga telang makalikasan. Nakikita rin sa resulta ang isang paraan ng paggamit ng *green pricing*, kung saan isinaalang-alang ng mga negosyante ang *gastusin* nila sa *packaging*. Ngunit, maaari na hindi mapapabili ang mga mamimili dahil sa mga pisikal na hitsura ng *packaging* na ginagamit (Magnier & Schoormans, 2015). Maaari na ito ay dahil sa paggamit ng mga negosyante sa mga lumang *paper bags* galing sa ibang mga tindahan upang magamit muli ang bagay na hindi na magagamit. Gayunpaman, ang *green disposal*, huling estratehiya ng *green marketing* ay nakikitang ginagamit ng mga negosyante sa paraan ng *pagre-recycle* o *pagdo-donate* ng basura. Sa panahon na ayaw na ng mga mamimili ang kanilang mga damit, pinipili nila kung ang mga damit ay itatapon sa basura, ibebenta, o ipamimigay sa nangongolekta ng mga telang gamit na (Zamani, 2014).

10. IMPLIKASYON

Batay sa mga resulta, lahat ng mga produktong pambabae na binebenta ng mga negosyante ay may layunin sa makatulong at buhayin ang kalikasan. May ilang negosyante na nagbigay pagpapahalaga sa pagliligtas ng kalikasan dahil sa paggamit ng estratehiyang *Green Marketing*. Gayundin, hindi lang nababawasan ang kanilang



basura na naiipon, ngunit, nababawasan rin ang kanilang gastusin dahil karamihan sa kanila ay gumagamit ng mga likas na yaman at *pagre-recycle ng materials* para sa kanilang *packaging*. At sa kabuuan ng pag-aaral na ito, may mas positibong dating ang green marketing sa kalikasan at sa mga negosyante.

11. LIMITASYON

Isa sa naging limitasyon ng pananaliksik na ito ay ang proseso ng pagkakaroon ng pakikipanayam. Dahil sa naganap ng mahigpit na *quarantine* o *lockdown* sa Pilipinas, ang pakikipanayam na isinagawa ng mananaliksik ay naganap sa pamamagitan ng pagtawag at *e-mail*. Naging hamon rin sa mananaliksik ang paputol-putol na *signal* o linya ng telepono sa oras ng pagtawag, kaya ang oras ng pakikipanayam ay lumampas sa orihinal na oras na binanggit bago ang pakikipanayam.

12. REKOMENDASYON

Kaugnay ng isinagawang pag-aaral, buong pagpapakumbabang iminumungkahi ng mananaliksik sa mga sumusunod:

Para sa mga mananaliksik sa hinaharap na mapalawak pa sana ang magiging saklaw ng mga piniling respondente dahil maaaring makatulong itong matukoy ng mas malawak ang pananaliksik kung madadagdagan ang bilang ng mga kalahok.

Para sa mga negosyante ng damit pambabae na ang paggamit ng *green marketing* ay makatutulong sa kalikasan.

Para sa mga mamimili ng damit pambabae upang makita nila ang kahalagahan ng pagsuporta sa mga produkto na gumagamit ng *green marketing*, ay may epekto sa kinabukasan ng kalikasan ng mundo.

13. PASASALAMAT

Taus-pusong pasasalamat ang aming ipinaabot sa mga sumusunod na indibidwal at tanggapan dahil sa mahahalagang tulong, kontribusyon, at.o suporta, tungo sa matagumpay na reyalisasyon ng pananaliksik na papel na ito:

1. Ang mga naging kalahok/respondente ng pananaliksik na papel na ito, sa paglalaan ng panahon at sa matapat na pagsagot sa aming inihandang kwestyuner,
2. Kay Danii Fajardo na naglaan ng oras upang maging tulong sa pagsusulat at pag-*proofread* sa pananaliksik na papel
3. Sa mga awtor, editor at mga mananaliksik ng mga akdang pinaghanguan naming ng mahahalagang impormasyong aming

ginagamit sa pagsulat ng una at ikalawang kabanata ng pananaliksik na papel,

4. Kay Gng. Bitancor (Pagbasa at Pagsusuri ng Iba't Ibang Teksto Tungo sa Pananaliksik), ang masisigasig naming dalubguro na gumabay sa amin sa tamang bakbangan sa pagsulat at paggawa ng isang pananaliksik na papel,
5. Sa aking mga magulang at pamilya, sa kanilang inilaan na suporta at tulong sa paghahanap ng respondente at tulong sa pagsusulat ng pananaliksik na papel, at higit sa lahat,
6. Sa Poong Maykapal, sa pagdinig sa aming mga dalangin lalung-lalo na sa sandaling kami ay pinanghihinaan na ng pag-asang matapos naming ito.

Muli, maraming-maraming salamat po.

14. MGA SANGGUNIAN

- Arseculeratne, D., & Yazdanifard, R. (2013). How Green Marketing Can Create a Sustainable Competitive Advantage for a Business. *International Business Research*, 7(1). doi: 10.5539/ibr.v7n1p130
- Alhamad, A. M., Junoh, M. Z. B. M., & Eneizan, B. (2019). Green Marketing Strategies: Theoretical Approach. *American Journal of Economics and Business Management*, 2(2), 77-94.
- Bianchi, C., & Birtwistle, G. (2010). Sell, give away, or donate: an exploratory study of fashion clothing disposal behaviour in two countries. *The International Review of Retail, Distribution and Consumer Research*, 20(3), 353-368.
- Bick, R., Halsey, E., & Ekenga, C. C. (2018). The global environmental injustice of fast fashion. *Environmental Health*, 17(1). doi: 10.1186/s12940-018-0433-7
- Bukhari, S. S. (2011). Green Marketing and its impact on consumer behavior. *European Journal of Business and Management*, 3(4), 375-383.
- Cervellon, M.-C., & Carey, L. (2011). *Critical Studies in Fashion & Beauty*, 2(1), 117- 138. doi:10.1386/csfb.2.1-2.117_1
- Cherian, J., & Jacob, J. (2012). Green marketing: A study of consumers' attitude towards environment friendly products. *Asian social science*, 8(12), 117.
- Dickenbrok, C., & Martinez, L. F. (2018). Communicating green fashion across different cultures and geographical regions. *International Review on Public and Nonprofit Marketing*, 15(2), 127-141. doi: 10.1007/s12208-018-0194-6
- Epstein, M. J. (2018). Making sustainability work: Best practices in managing and measuring corporate social, environmental and economic impacts. Routledge.
- Gam, H. J., & Banning, J. (2011). Addressing sustainable apparel design challenges with problem-based learning. *Clothing and Textiles Research Journal*, 29(3), 202-215.
- Gardetti, M. A., & Muthu, S. S. (Eds.). (2020). *The UN Sustainable Development Goals for the Textile and Fashion Industry*. Springer.



- Iannuzzi, A. (2017). *Greener Products: The Making and Marketing of Sustainable Brands*. CRC Press.
- Kim, H.-S., & Hall, M. L. (2015). Green Brand Strategies in the Fashion Industry: Leveraging Connections of the Consumer, Brand, and Environmental Sustainability. *Sustainable Fashion Supply Chain Management*, 31–45. doi:10.1007/978-3-319-12703-3_2
- Koszewska, M. (2015). Understanding Consumer Behavior in the Sustainable Clothing Market: Model Development and Verification. *Environmental Footprints and Eco-Design of Products and Processes*, 43–94. doi:10.1007/978-981-10-0111-6_3
- Kumar, R. (2017). Prospects of Sustainable Fashion Design Innovation. *International Journal of Textile and Fashion Technology (IJTFT)*, 7 (6), 5, 14.
- Larashati, H., Hudrasyah, H., & Chandra, N. (2012). 7Ps of green marketing as factors influencing willingness to buy towards environmentally friendly beauty products. In *Proceedings of International Conference on Business Management & IS (Vol. 1, No. 1)*.
- Lee, S. (2011). Consumers' Value, Environmental Consciousness, and Willingness to Pay more toward Green-Apparel Products. *Journal of Global Fashion Marketing*, 2(3), 161–169. doi: 10.1080/20932685.2011.10593094
- Magnier, L., & Schoormans, J. (2015). Consumer reactions to sustainable packaging: The interplay of visual appearance, verbal claim and environmental concern. *Journal of Environmental Psychology*, 44, 53e62.
- Mishra, P., & Sharma, P. (2014). Green marketing: Challenges and opportunities for business. *BVIMR Management Edge*, 7(1).
- Niinimäki, K., & Hassi, L. (2011). Emerging design strategies in sustainable production and consumption of textiles and clothing. *Journal of cleaner production*, 19(16), 1876-1883.
- Ottman, J. (2017). *The new rules of green marketing: Strategies, tools, and inspiration for sustainable branding*. Routledge.
- Polonsky, M. J. (2011). Transformative green marketing: Impediments and opportunities. *Journal of Business Research*, 64(12), 1311-1319.
- Saini, B. (2013). Green marketing and its impact on consumer buying behavior. *International Journal of Engineering Science Invention*, 2(12), 61-64.
- Sarkar, A. N. (2012). Green branding and eco-innovations for evolving a sustainable green marketing strategy. *Asia-Pacific Journal of Management Research and Innovation*, 8(1), 39-58.
- Smith, K. T., & Brower, T. R. (2012). Longitudinal study of green marketing strategies that influence Millennials. *Journal of Strategic Marketing*, 20(6), 535–551. doi: 10.1080/0965254x.2012.711345
- Sohail, M. S. (2017). Green marketing strategies: how do they influence consumer-based brand equity?. *Journal for Global Business Advancement*, 10(3), 229-243.
- Workman, J. E., & Lee, S.-H. (2010). Materialism, fashion consumers and gender: a cross-cultural study. *International Journal of Consumer Studies*, 35(1), 50–57. doi: 10.1111/j.1470-6431.2010.00935.x
- Yenipazarli, A., & Vakharia, A. (2015). Pricing, market coverage and capacity: Can green and brown products co-exist?. *European Journal of Operational Research*, 242(1), 304-315.
- Zamani, B. (2014). Towards understanding sustainable textile waste management: Environmental impacts and social indicators.



Externalizing Behaviors and Family Influences on Filipino Urban Adolescents: A Social Learning Theory Approach

Joseph David H. Melliza, Renzo O. Pocsidio, Joaquim O. Rizal
Josef Angelo Tagupa, and Andre Elijah B. Techico
De La Salle University Integrated School, Manila

Abstract: This study will look through Bandura's Social Learning Theory perspective on how parental influence predicts Filipino adolescents' externalizing behaviors. As children are impressionable, they observe their parents as role models; their behavior development from childhood to adolescence is dependent on parental influence. With this in mind, the study's research objectives aim to understand how parental influences, such as abusive and antisocial behavior, affect the adolescent's externalizing behavior and the level of externalizing behaviors among Filipino adolescents living in Metro Manila, Philippines. The researchers then surveyed 202 Filipino adolescents residing in Metro Manila, answering a questionnaire that measured family characteristics, perceived abusive and antisocial behavior of parents, and self-assessed level of externalizing behaviors. The data gathered was processed through descriptive and inferential statistics, and the results concluded that family influence does have significance in the adolescent's externalizing behavior. In conclusion, through Social Learning Theory and the data collected, the adolescent's externalizing behaviors were found to be due to family influence.

Key Words: Adolescents, Externalizing Behaviors, Family Influence, Social Learning Theory, Perceived Abusive Behaviors of Parents

1. INTRODUCTION

1.1. Externalizing Behaviors among Adolescents: Concept and Trends

Adolescents worldwide often exhibit externalized behaviors. Common intuition dictates that externalized behaviors stem from the adolescent's emotions caused by an imbalance of hormone production within the brain. But we can see that family influences, hereditary or genetic influences, and the adolescent's environment can cause adolescents to manifest these externalized behaviors (Bishop et al., 2002). Reviewing the trends of adolescent externalized behaviors will significantly impact the field of psychiatry and mental health nursing as adolescent externalized behaviors strongly predict a later life of disruptive behavior towards people, which may result in violence, substance abuse, or crime (Perry & Price, 2018)

Externalized behaviors are defined as a group of behavior problems directed to an external environment (Externalizing Behaviors: Examples & Definition, 2015). These behaviors are generally regarded as negative behaviors as they may be disruptive towards others and toward the external environment (Campbell, 2000; Bishop et al., 2002). In this study, these refer to destructive behaviors or conduct manifested by the respondent.

Also, externalized Behaviors are dimensionalized into two domains: delinquency and aggressive behavior. According to Liu (2004), aggressive behavior is a form of externalizing behavior that can be defined as verbal or physical behaviors that harm or threaten to harm others. These behaviors include attacking others and being involved in fights. On the otherhand, delinquency refers to non-violent forms of antisocial behaviors instead of the violent acts within the scope of the earlier concept of aggressive behavior. Delinquent behaviors include minor forms of misconduct such as disrespecting authority, lying, bullying, skipping school, and more (Liu, 2004).

1.2. Understanding Family Influences: A Social Learning Approach

Paragraph 1: Trends of family influences among adolescents

The family plays a crucial role in how a child develops traits and characteristics, often being influenced by the actions of the parents (De Figueiredo, 2012). Moreover, the impact of family influences on adolescents can be examined through common observation, to psychoanalyzing the behaviors and actions of the parents around the children. In this study, externalized behaviors such as aggression and delinquency, and their ties to family



influences will be reviewed. Ludht and Freyberger (2004) reported that aggression and delinquency had a significant relationship between perceived parental rejection and abusive behavior. We can infer that influence from the family is a vital part in the manifestation of these behaviors. This study will utilize Bandura's (1977) social learning theory to expound further and explain this occurrence.

Social Learning Theory was a theoretical framework proposed by Albert Bandura in 1977 which suggests that a person can acquire new behaviors through observing and imitating the behaviors of live, symbolic, or verbal instructional models. This theory also states that learning is influenced by both external reinforcement and internal reinforcement. Bandura also describes how humans actively process information and understand the relationship between actions and their respective consequences through the mediational process. The mediational process has four steps: attention, retention, reproduction, and motivation. This study focused on how external influences affect the cognitive function of an individual.

As this study will focus on the relationship between the parents and adolescent, the researchers will utilize Bandura's Social Learning Theory to identify if family influences, more specifically, perceived family influences, could incite changes in the adolescent's behavior. This study will focus on parents' perceived abusive behaviors, specifically, aggressive tendencies, antisocial behaviors, intoxication to alcohol and alcohol encouragement, and externalizing behaviors within the respondent, specifically, aggressive behavior and delinquency.

1.3. RESEARCH OBJECTIVES

This study describes the level of externalizing behaviors among Filipino urban adolescents in Metro Manila. It determines different family influences such as family characteristics, abusive, and antisocial behaviors of parents on their externalizing behavior levels. Specifically, this answers the following questions:

1. What is the level of externalizing behaviors among Filipino urban adolescents in Metro Manila, Philippines?
2. How do family influences such as family characteristics, abusive, and antisocial behaviors of parents affect their externalizing behavior levels?

2. METHODOLOGY

This study determines how externalizing behaviors are affected by family influences. These family influences are construed as the influence of structures and dynamics in the family on

externalizing behaviors of children through learning and socialization (Smith & Stern, 1997). With that, the theoretical-methodological approach of social learning theory is most appropriate in understanding family influences on externalizing behaviors. The social learning approach looks into how behaviors are formed based on modeling, exposure, and imitation of other people's behavior (Bandura, 1977). This approach looks at how cognitive and environmental factors influence learning and behavior (Bandura, 1977).

As for the research design, a cross-sectional study approach was used, designed for the researchers to observe current behaviors and outcomes simultaneously (Setia, 2016). This cross-sectional approach measures the current assessments of respondents on their perceived level of externalizing behaviors, family characteristics, and perceived abusive behaviors and antisocial behaviors of their parents.

A total of 202 Filipino urban adolescents in Metro Manila participated as a sample of this study. Respondents were asked to participate in this study via e-mail and other online platforms as a technique of data collection. The sample included in this study satisfied the criteria of having parents drinking alcohol and have seen antisocial behaviors also among parents. Responses were collected using a survey questionnaire. This instrument measured their family characteristics, perceived abusive and antisocial behaviors of parents, and self-assessed level of externalizing behaviors.

The results from this survey were encoded in MS Excel and analyzed using Jamovi. This study analyzed quantitative data through descriptive and inferential statistics. Family characteristics were described through frequency counts and percentages. The description of perceived abusive and antisocial behavior of parents and self-assessed level of externalizing behavior used means and standard deviations. Concerning inferential statistics, the Independent Sample T-test was employed to determine differences of categorical variables in relation to externalizing behaviors. Pearson's r correlation coefficient test was also used to determine the relationship of perceived abusive and antisocial behaviors of parents with externalizing behaviors. Lastly, a hierarchical regression analysis was used to determine the effects of family influences on externalizing behaviors.

3. RESULTS AND DISCUSSION

Table 1 presents the descriptive statistics on the externalizing behaviors and perceived abusive behaviors of parents among Filipino urban adolescents. Based on the findings on the externalizing behaviors of respondents, aggressive



behaviors are more common ($M = 2.14$, $SD = 0.74$) compared to delinquency behaviors ($M = 1.62$, $SD = 0.74$). This means that the respondents manifested aggressive behaviors more than delinquency as forms of externalizing behaviors.

Regarding forms of perceived abusive behaviors of parents assessed by the respondents, on the one hand, antisocial behaviors ($M = 2.51$, $SD = 0.96$) and aggressive tendencies ($M = 2.24$, $SD = 1.21$) have the highest levels of perceptions. On the other hand, alcohol encouragement has the lowest average scores of perceived abusive behaviors of parents ($M = 1.56$, $SD = 0.64$).

Table 1. Descriptive Statistics, $n=202$

Variables	Mean	SD	Maximum	Minimum
Externalizing Behaviors				
Aggressive Behaviors	2.14	0.74	5	1
Delinquent Behaviors	1.62	0.74	5	1
Abusive Behaviors of Parents				
Aggressive Tendencies	2.24	1.21	5	1
Alcohol Encouragement	1.56	0.64	5	1
Antisocial Behaviors	2.51	0.96	5	1
Intoxication to Alcohol	2.08	0.74	5	1

Pearson's r Correlation Coefficient Test Results

Table 2 presents the significant correlations using the Pearson's r correlation coefficient test. Based on the result, perceived forms of abusive behaviors of parents are statistically significant correlates for both aggressive and delinquent behaviors of adolescents. Regarding aggressive behaviors, all abusive behaviors except alcohol encouragement have substantial correlations. Among perceived forms of abusive behaviors of parents, aggressive tendencies have the highest strength among other correlates. Aggressive tendencies of parents has a moderately strong and positive correlation with the aggressive behaviors of adolescents $r(202) = 0.448$, $p < .001$. This means that the higher the level of aggressive tendencies of parents, the higher also the aggressive behaviors of adolescents. As explained by Bandura (1977), in Social Learning Theory, perceived aggressive tendencies of the parent are observed and imitated by the child, which turns into an externalized behavior. Another explanation from Bandura's theory is that the parents' aggressive behaviors can act as a stimulus for a mediational process, which in turn, manifests this form of externalized behavior.

Regarding delinquent behaviors of respondents, all abusive behaviors also have significant correlations. Among perceived forms of abusive behaviors of parents, alcohol encouragement

has the highest strength among other correlates. Alcohol encouragement has a moderately strong and positive correlation with the delinquent behaviors of adolescents $r(202) = 0.363$, $p < .001$. This means that the more adolescents were encouraged to drink alcohol by their parents, the more they manifest delinquent behaviors. This is related to the findings of Lee et al., (2016), which states that parents who encourage alcohol use will cause self-delinquency amongst adolescents. Social Learning Theory also presents that parental alcohol use can encourage their child to think that this behavior is non-problematic and justifiable. This behavior also predicts the child's high-risk behavior, such as alcohol use, substance abuse, and hostility.

Table 2. Correlation Coefficients, $n=202$

Variables	1	2	3	4	5	6
Externalizing Behaviors						
1. Aggressive Behaviors	1.00					
2. Delinquent Behaviors	0.331***	1.00				
Abusive Behaviors of Parents						
3. Aggressive Tendencies	0.448***	0.332***	1.00			
4. Alcohol Encouragement	0.127	0.363***	0.197**	1.00		
5. Antisocial Behaviors	0.345***	0.225***	0.569***	0.077	1.00	
6. Intoxication to Alcohol	0.118***	0.316***	0.069	0.425***	0.053	1.00

* $p\text{-value} < 0.05$; ** $p\text{-value} < 0.01$, *** $p\text{-value} < 0.001$

Multiple Linear Regression Analysis Results

Table 3 presents the multiple linear regression results. Based on the findings, perceived abusive behaviors of parents significantly explains 20% of the variance in aggression scores of respondents, $R^2 = 0.20$, $F(4, 202)$, $p < 0.001$. Moreover, perceived abusive behaviors of parents, in another model, significantly explains 22% of the variance in the delinquency scores of the respondents, $R^2 = 0.22$, $F(4, 202)$, $p < 0.001$.

In model 1, only perceived aggressive tendencies of parents significantly and positively predict the aggressive behaviors of adolescents, $\beta = 0.28$, $t(202) = 4.69$, $p < .001$. Social learning theory by Bandura (1977) explains that children mimic the behavior of their parents as they see it as non-problematic. As children observe this behavior from their parents, children will mimic the behavior by



seeing that aggression is an effective manner to attain what they want.

In model 2, perceived aggressive tendencies, alcohol encouragement, and intoxication to alcohol among parents significantly and positively predict the delinquent behaviors of adolescents, $\beta = 0.18$, $t(202) = 3.10$, $p < .01$; $\beta = 0.26$, $t(202) = 3.23$, $p < .01$; $\beta = 0.12$, $t(202) = 2.91$, $p < .01$, respectively. This is related to the findings of You and Liu's (2015) study, which states that abusive behavior from parents has a significant effect on both violent and nonviolent delinquent behaviors. Social learning theory also presents that adolescents manifest delinquent behavior due to these abusive behaviors being reinforced to have them view these behaviors as something desirable to have.

Table 3. Multiple Linear Regression Results, $n=202$

Model	Covariates	β	t-statistic	p-value	Adjusted r^2	F-statistic	p-value
1 (Aggression)	Abusive Behaviors of Parents				0.20	13.9**	<.001
	Aggressive Tendencies	0.28***	4.69	<0.001			
	Alcohol Encouragement	0.01	0.14	0.887			
	Antisocial Behaviors	0.13	1.72	0.087			
	Intoxication to Alcohol	0.05	1.16	0.246			
2 (Delinquency)	Abusive Behaviors of Parents				0.22	15.4**	<.001
	Aggressive Tendencies	0.18**	3.10	<0.01			
	Alcohol Encouragement	0.26**	3.23	<0.01			
	Antisocial Behaviors	0.06	0.81	0.419			
	Intoxication to Alcohol	0.12**	2.91	<0.01			

* p -value<0.05; ** p -value<0.01, *** p -value<0.001

4. CONCLUSIONS

This study provides an insight on how externalized behaviors are affected and manifested by adolescents through family influences, explicitly focusing on their parent's abusive behaviors such as aggressive tendencies, alcohol encouragement, level of intoxication to alcohol, and general antisocial behaviors. With that, the study's findings give importance to how children are affected by external influences—namely, family influences on their development and behaviors.

To conclude, through the social learning theory and this data, it is observable that the externalized behaviors that can be manifested by children can be affected by the parents' influences.

This could be inferred through children being impressionable in their formative years as they grow up.

For the aggressive behaviors of an adolescent, it can be observed that parent's aggressive tendencies and the other abusive behaviors parents exhibit can heavily influence this as these domains are seen to be a significant predictor for onset manifestation for aggression as an externalized behavior. We can say the same thing for the delinquency variable; with aggression directly related to delinquency, we can infer from the data and the theoretical approach that parents' abusive behavior is also a solid and significant predictor for delinquency being manifested as an externalized behavior.

Since this study primarily focuses on how family influences can affect how externalized behaviors are manifested, future research could be done on how different influences in adolescents' lives could affect them. Future studies use Bandura's concept on the Social Learning Theory, as well as other concepts and theoretical frameworks, to understand further the ever-changing dynamics of a modern family and our understanding of the emotional development of an adolescent.

5. ACKNOWLEDGEMENTS

The researchers would like to acknowledge and sincere gratitude to Mr. Wilfred Luis Clamor, for assisting them throughout the span of this research; aiding them in specifying the study's scope, assistance in understanding statistical tools and analysis, and guiding them in creating the research, and offering his unwavering support for the group. The researchers would also like to acknowledge their parents, guardians, and siblings for providing them this opportunity to create a research paper, and for their unconditional love and support given in the midst of the pandemic, as well as all our teachers who equipped us with the knowledge we needed to conduct this research.

6. REFERENCES

Bandura, A. (1978). Social Learning Theory. Retrieved from http://www.asecib.ase.ro/mps/Bandura_SocialLearningTheory.pdf

Barnow, S., Lucht, M., & Freyberger, H. (2004). Correlates of aggressive and delinquent conduct problems in adolescence. *Aggressive Behavior*, 31(1), 24-39. doi:10.1002/ab.20033

Bernhardt, N., Obst, E., Nebe, S., Poeseh, S., Wurst, F., Wolfgang, W. Smolma, M.,

Zimmerman, U. (2019, January 24). Acute alcohol effects on impulsive choice in adolescents 2019. Retrieved August 27, 2020, from <https://journals.sagepub.com/doi/abs/10.1177/0269881118822063>



- Bishop, S. A., Okagbue, H. I., & Odukoya, J. A. (2020). Statistical analysis of childhood and early adolescent externalizing behaviors in a middle low income country. *Heliyon*, 6(2), e03377. <https://doi.org/10.1016/j.heliyon.2020.e03377>
- Brook, J. S., Lee, J. Y., Finch, S. J., & Brown, E. N. (2012). The Association of Externalizing Behavior and Parent-Child Relationships: An Intergenerational Study. *Journal of child and family studies*, 21(3), 418–427. <https://doi.org/10.1007/s10826-011-9493-9>
- Chartrand, T. L., & Bargh, J. A. (1999). The chameleon effect: The perception-behavior link and social interaction. *Journal of Personality and Social Psychology*, 76(6), 893–910. <https://doi.org/10.1037/0022-3514.76.6.893y>
- Clark, D. B., Vanyukov, M., & Cornelius, J. (2002). Childhood Antisocial Behavior and Adolescent Alcohol Use Disorders. *Alcohol Research & Health*. <https://www.ncbi.nlm.nih.gov/pmc/articles/PMC6683823/>.
- Collins, S. E. (2016). Associations Between Socioeconomic Factors and Alcohol Outcomes. *Alcohol Research : Current Reviews*. <https://www.ncbi.nlm.nih.gov/pmc/articles/PMC4872618/>.
- De Figueiredo, C. R. (2012, November 30). Families: Influences in Children's Development and Behaviour, from Parents and Teachers' Point of View. Retrieved from <https://eric.ed.gov/?id=ED539404>
- Donnellan, M. B., Trześniewski, K. H., Robins, R. W., Moffitt, T. E., & Caspi, A. (2005, April 1). Low Self-Esteem Is Related to Aggression, Antisocial Behavior, and Delinquency. Retrieved from <https://journals.sagepub.com/doi/abs/10.1111/j.0956-7976.2005.01535.x>
- Dube, S. R., Anda, R. F., Felitti, V. J., Croft, J. B., Edwards, V. J., & Giles, W. H. (2001). Growing up with parental alcohol abuse. *Child Abuse & Neglect*, 25(12), 1627–1640. doi:10.1016/s0145-2134(01)00293-9
- Duncan, T. E., Duncan, S. C., & Hops, H. (1994). The effects of family cohesiveness and peer encouragement on the development of adolescent alcohol use: a cohort-sequential approach to the analysis of longitudinal data. *Journal of Studies on Alcohol*, 55(5), 588–599. doi:10.15288/jsa.1994.55.588
- Edwards, A. C., Lönn, S. L., Karriker-Jaffe, K. J., Sundquist, J., Kendler, K. S., & Sundquist, K. (2017). Time-specific and cumulative effects of exposure to parental externalizing behavior on risk for young adult alcohol use disorder. *Addictive Behaviors*, 72, 8-13. <https://doi.org/10.1016/j.addbeh.2017.03.002>
- Eiden, R., Molnar, D., Colder, C., Edwards, E., & Leonard, K. (2009). A Conceptual Model Predicting Internalizing Problems in Middle Childhood Among Children of Alcoholic and Nonalcoholic Fathers: The Role of Marital Aggression. *Journal of Studies on Alcohol and Drugs*. <https://www.jsad.com/doi/10.15288/jsad.2009.70.741>.
- Forward, S., & Buck, C. (2002). What is a Toxic Parent? In *Toxic parents: overcoming their hurtful legacy and reclaiming your life*. introduction, Bantam Books.
- Holmila, M., Jääskeläinen, M., Raitasalo, K. & Santalahti, P. (2019). The effect of the severity of parental alcohol abuse on mental and behavioural disorders in children. *Eur Child Adolesc Psychiatry* 28, 913–922. <https://doi.org/10.1007/s00787-018-1253-6>
- Irons, D. E., Iacono, W. G., & McGue, M. (2015). Tests of the effects of adolescent early alcohol exposures on adult outcomes. *Addiction (Abingdon, England)*, 110(2), 269–278. <https://doi.org/10.1111/add.12747>
- K. E., Anderson, H. L., L. Arseneault, T. E. M., R. A., Barkley, J. K., J. E., Bates, G. S. P., T. P., Beauchaine, C. W.-S., S. A., Burt, R. K., ... C., Webster-Stratton, M. J. R. (1986, January 1). Relationships Between Parental Negativity and Childhood Antisocial Behavior over Time: A Bidirectional Effects Model in a Longitudinal Genetically Informative Design. *Journal of Abnormal Child Psychology*. <https://link.springer.com/article/10.1007/s10802-007-9151-2>.
- Kerr, D. C., Capaldi, D. M., Pears, K. C., & Owen, L. D. (2012). Intergenerational influences on early alcohol use: independence from the problem behavior pathway. *Development and psychopathology*, 24(3), 889–906. <https://doi.org/10.1017/S0954579412000430>
- Kauten R., Barry C.T. (2020) Externalizing Behavior. In: Zeigler-Hill V., Shackelford T.K. (eds) *Encyclopedia of Personality and Individual Differences*. Springer, Cham. https://doi.org/10.1007/978-3-319-24612-3_894
- Lee, J. Y., Brook, J. S., Nezia, N., & Brook, D. W. (2016). Adolescent predictors of alcohol use in adulthood: A 22-year longitudinal study. *The American Journal on Addictions*, 25(7), 549–556. doi:10.1111/ajad.12438
- Liu J. (2004). Childhood externalizing behavior: theory and implications. *Journal of child and adolescent psychiatric nursing : official publication of the Association of Child and Adolescent Psychiatric Nurses, Inc*, 17(3), 93–103. <https://doi.org/10.1111/j.1744-6171.2004.tb00003.x>
- Marmorstein, N. R., Iacono, W. G., & McGue, M. (2009). Alcohol and illicit drug dependence among parents: associations with offspring externalizing disorders. *Psychological medicine*, 39(1), 149–155. <https://doi.org/10.1017/S0033291708003085>
- Martin, S. (2015). Signs you have toxic parents. <https://blogs.psychcentral.com/imperfect/discuss/4326>.
- Manthey, J., Shield, K. D., Rylett, M., Hasan, O. S. M., Probst, C., & Rehm, J. (2019). Global alcohol exposure between 1990 and 2017 and forecasts until 2030: a modelling study. *The Lancet*, 393(10190), 2493–2502. doi:10.1016/s0140-6736(18)32744-2
- McDowell, Y. E., Vergés, A., & Sher, K. J. (2019). Are Some Alcohol Use Disorder Criteria More (or Less) Externalizing than Others? Distinguishing Alcohol Use Symptomatology from General Externalizing Psychopathology. <https://www.ncbi.nlm.nih.gov/pmc/articles/PMC6397083/>.
- Orue, I. Brad, Bushman, B. J., Calvete, E., Thomaes, S., de Castro, B. O. Hutteman, R.. (2011). Monkey see, monkey do, monkey hurt: Longitudinal effects of exposure to violence on children's aggressive behavior. *SAGE Journals*. <https://journals.sagepub.com/doi/abs/10.1177/1948550610396586>
- Ringel, J. S., Collins, R. L., & Ellickson, P. L. (2006). Time Trends and Demographic Differences in Youth Exposure to Alcohol Advertising on Television. *Journal of Adolescent Health*, 39(4), 473–480. doi:10.1016/j.jadohealth.2006.02.006



- Ruhland, E. L., Davis, L., Atella, J., & Schlafer, R. J. (2020). Externalizing Behavior Among Youth With a Current or Formerly Incarcerated Parent. *International journal of offender therapy and comparative criminology*, 64(1), 3–21. <https://doi.org/10.1177/0306624X19855317>
- Rüütel, E., Sisask, M., Värnik, A., Värnik, P., Carli, V., Wasserman, C., ... Wasserman, D. (2014). Alcohol Consumption Patterns among Adolescents are Related to Family Structure and Exposure to Drunkenness within the Family: Results from the SEYLE Project. *International Journal of Environmental Research and Public Health*, 11(12), 12700–12715. doi:10.3390/ijerph111212700
- Sigman, A. (2020). Covid-19 and alcohol: Parental drinking influences the next generation. <https://www.bmj.com/content/369/bmj.m2525.short>
- Wall, A. E., Barth, R. P., & The NSCAW Research Group. (2005). Aggressive and Delinquent Behavior of Maltreated Adolescents: Risk Factors and Gender Differences. *Stress, Trauma and Crisis: An International Journal*, 8(1), 1–24. <https://doi.org/10.1080/15434610490888081>
- Wright, J. P., & Cullen, F. T. (2001). Parental Efficacy and Delinquent Behavior: Do Control and Support Matter? *Criminology*, 39(3), 677-706. doi:10.1111/j.1745-9125.2001.tb00937.x
- Williams.(n.d.) Aggressive Behaviors: Types and Signs. <https://study.com/academy/lesson/aggressive-behavior-definition-types-signs.html>.
- Wilson, M. N., Langille, D. B., Ogilvie, R., & Asbridge, M. (2018). When parents supply alcohol to their children: Exploring associations with drinking frequency, alcohol-related harms, and the role of parental monitoring. *Drug and alcohol dependence*, 183, 141–149. <https://pubmed.ncbi.nlm.nih.gov/29248692/>
- Wuensch, Karl L. (2005). "What is a Likert Scale? and How Do You Pronounce 'Likert?'" . East Carolina University. <http://core.ecu.edu/psyc/wuenschk/StatHelp/Likert.htm>
- Whiteside, S. P., & Lynam, D. R. (2003). Understanding the role of impulsivity and externalizing psychopathology in alcohol abuse: application of the UPPS impulsive behavior scale. *Experimental and clinical psychopharmacology*, 11(3), 210–217. <https://doi.org/10.1037/1064-1297.11.3.210>
- You, S., & Lim, S. A. (2015). Development pathways from abusive parenting to delinquency: the mediating role of depression and aggression. *Child abuse & neglect*, 46, 152–162. <https://doi.org/10.1016/j.chiabu.2015.05.009>
- Zeigler-Hill, V., & Shackelford, T. K. (Eds.). (2020). *Encyclopedia of Personality and Individual Differences*. doi:10.1007/978-3-319-24612-3



Behaviors as Predictors of Reinforcement: Investigating Parent’s Psychological Antecedent and Parental Engagement Mechanisms in Distance Learning

Raven Marie C. Imperial, Joanna Onieceline Faye G. Cinco
and Angelou S. Lasaga
Zamboanga del Norte National High School, Dipolog City, Zamboanga del Norte

Abstract: Due to COVID-19, remote learning gave way to implementing modular and online setup of acquiring education. Several studies resulted in the efficacy of parent's commitment to the achievement of their children academically. The research seeks to determine the relationship between parental engagement and their psychological antecedent with the use of a 4-point Likert Scale intervened by parent’s demographic profile in terms of gender, age, type of modular learning, number of children enrolled in S.Y. 2020 to 2021, and educational background. Validation of the questionnaire was calculated using Cronbach's alpha coefficient formula through the SPSS software. The computed alpha coefficient was 0.96, which is acceptable reliability. Additionally, with 301 parents, researchers evaluated the gathered data through Pearson Correlation and Regression analysis. The results implied that between the parent's psychological antecedent and engagement in their children's remote learning, parent's psychological behavior influences change in their commitment and determination to guide and teach their children amidst the COVID-19 pandemic. It has also been acknowledged through regression analysis that parental engagement mechanisms are best predicted by the demographic's profile of parents, specifically concerning gender and their children’s remote learning modalities and their psychological antecedent amidst the pandemic. Hence, future researchers must employ longitudinal studies to determine parent's display of behavior during and after the remote learning environment for further investigation.

Key Words: distance learning; parental engagement; psychological antecedent; behavior; COVID-19 Pandemic

1. INTRODUCTION

The COVID-19 pandemic has progressed our lives to an entirely different and distinctive level. The ability of personal contact and joining crowds were diminished to dodge the spread of infection. Subsequently, the birth of technological and online setups was employed dominantly, especially in educational fields, given the context of the pandemic.

Since school systems are disrupted and educational opportunities are impacted in multiple ways, more collaboration is needed from various parties, namely schools, teachers, parents, and children (Azani et al.) In such an event, parental involvement mechanisms (facilitating, instructing, and organizing) are necessary to help children prevail in the education programs bundled by the public authority and schools. However, these mechanisms are influenced by a psychological antecedent- a precipitating event that cues an individual to perform a behavior of avoidance, aggression, or stigma. These antecedents portray a unique role while endeavoring to trigger positive and negative results in remote

learning. Given that, the level of parental involvement is determined whenever a psychological antecedent is being activated by the parents.

1.1 Parent’s Psychological Antecedent

Otherwise called as "setting event," the psychological antecedent alludes to any activity, circumstance or behavior that led up to a conduct and production of reinforcement. This element frames strategic methods of parents in terms of educational engagement.

For instance, it is either pivotal- meaning it leads to the creation of desirable outcomes- a positive execution of parenting practices and engagement, or undesirable outcomes- a problem that raises danger or distraction of parents towards the way they fulfill teaching responsibilities. This event might urge parents in detaching themselves towards helping their child in the academe.

Taking account the element of antecedent, a reinforcement is determined. This serve as a consequence of action or response from the antecedent



obtained. The reinforcement necessarily means as a disciplinary action or effort and collaboration provided as predictors to their child’s academic outgrowth.

1.2 Parental Engagement

As support mechanisms for online learning continue to evolve, parental engagement plays a significant role in any effort to enhance learning outcomes. Studies show that there is a strong correlation between parent participation and student success. Perhaps for both face-to-face and virtual courses, it would be feasible.

Involvement can be described as the act of participating in an activity or event or situation. In contrast, engagement can be described as the feeling of being involved in a specific activity or a formal arrangement to meet or do something with someone, particularly as part of your public duties "(Macmillan Dictionary, 2009-2012). If we take these two principles together, engagement appears to involve more than activity. There is a greater sense of ownership than there is in mere participation. It suggests that parents' involvement needs greater participation

and greater participation of acts than the participation of parents in schools (Goodall & Montgomery, 2014). Harris and Goodall (2016) stated that parental engagement is "the worst problem and the best solution." Unfortunately, researchers studying parental involvement have concentrated almost entirely on face-to-face environments, and very little is known about parental involvement in online settings.

As stated by Hoover-Dempsey and Sandler (2015), established not only how parents are engaged in their students' learning but also why parents are employed. Maintained parental involvement, the parents were motivated by (1) the expectation that they should be involved; (2) the conviction that their involvement would promote the success of their children; (3) the awareness born from the observation of their children and schools, that their involvement is necessary; (4) the perception of unique invitations from the school, their children or the teacher to be engaged; and (5) the perception of their expertise.

Russell (2017) said that parent monitoring should be directed towards students' academic integrity as the physical separation of teachers and students creates a lack of academic trustworthiness surveillance that parents must fulfill. Researchers have recognized that online student parents can track technological and expected issues.

Previous studies on parental involvement have explored its correlation with the success rate on children's cognitive and social fulfillment while scrutinizing a single factor of influence- the level of parental education. There have been several calls for further research to better understand parent

involvement in distance learning (Black, 2009; Cavanaugh et al., 2009; Rice, 2009).

This study uses the Adolescent Community of Engagement (ACE) developed by Borup et al. (2014), using existing research on online learning frameworks towards how parents, teachers, and peers affect students' learning development due to their foregoing emotional behavior. There have been several calls for further research to better understand parent involvement in distance learning (Black, 2009; Cavanaugh et al., 2009; Rice, 2009).

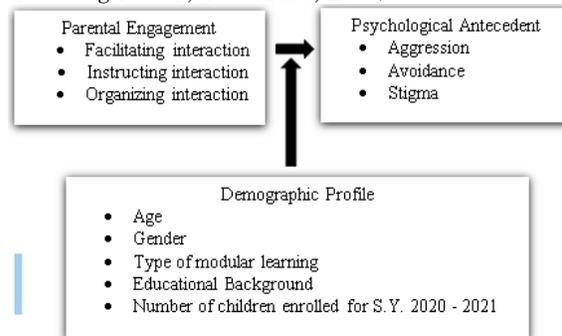

Schematic Diagram of the Study

This study used ACE by Borup et al. (2014) to elaborate the relationship between parent’s engagement and psychological antecedent. The Parental Engagement employed served as the dependent variable consisting (a) facilitating interaction, (b) instructing interaction and (c) organizing interaction. On the other hand, Psychological antecedent served as the independent variable consisting (a) aggression, (b) avoidance, and (c) stigma. These two variables will be then intervened by parent’s demographic profile in term of (a) age, (b) gender, (c) type of modular learning, (d) number of children enrolled in S.Y. 2020 to 2021, and (e) educational background.

Hence, this study was conducted to investigate the relationship between parent’s psychological antecedent and engagement with regards to the demographic profiles of the parents in terms of gender, age, educational background, number of children in school, and children’s type of remote learning material as influences in conducting and measuring the validity of parental involvement mechanisms during 2020 COVID-19.

2. METHODOLOGY

A correlational study was conducted to determine the value of variables and see whether there is an existing and significant relationship between them. The instrument utilized in this study is a quantitative methodology that employed questionnaires consisting of 63 items that were adapted from the HooverDempsey and Sandler’s



(2005) study to measure the three parental mechanisms. The survey was refined by excluding items that are only relevant to face-to-face school involvement. The refined survey obtains a four-point Likert-type response scale: 1=never, 2=rarely, 3=sometimes, 4=often. Given the limited personal interactions, the survey was made and distributed digitally. This survey aims to accumulate sufficient data relating to the study's objectives since it plays as the study's principal instrument.

This study's target participants are parents with children enrolled in S.Y 2020-2021 amidst the pandemic. The parents were selected through the identification of having children who obtained a material of online learning, digital modules, or printed modules for their scholarly activities. The numerical data gathered will be analyzed through Microsoft Excel and Statistical Package for the Social Sciences (SPSS). Mean scores and percentage count will be used to determine the description of the data. Furthermore, Pearson's correlation coefficient and multiple regression analysis will measure the relationship between the parents' psychological antecedent and parental engagement, which are being moderated by the parents' demographic profile.

3. RESULTS AND DISCUSSION

In order to derive implications, computing of continuum is first required to obtain specific ranges. Continuum was computed by $(n-1)/n$ where n is the number of description in 4 point-Likert scale namely: never, rarely, sometimes and often, in which in this case is 4. Hence, $(4-1)/4$ is equivalent to 0.75. Given that, the range is 0.75 resulting to the numerical data on continuum. Moreover, the questions under facilitating, instructing, organizing, aggression & avoidance served as negative questions while stigma is served as positive formulated questions on the questionnaire. Thus, the implications of both positive and negative questions are opposite from each other.

Table 1. The process on how are the data evaluated to form implications.

Continuum	Description	Implication for facilitating, instructing, organizing, aggression avoidance &	Implication for stigma
1.00 – 1.75	Never	Low	Very High
1.76 – 2.50	Rarely	Moderate	High
2.51 -3.25	Sometimes	High	Moderate
3.26 – 4.00	Often	Very High	Low

Table 2. The Demographic total in terms of gender, age, type of modality, number of children and educational background.

Demographic Profile	Dimension	Total
Gender	Female	189
	Male	112
Age	20s	57
	30s	99
	40s	119
	50s	26
Type of Modality	Online	101
	Digital	95
	Printed	105
Number of children	1-2	157
	3-4	126
	5-6	13
Educational Background	High school	59
	College	206
	Master's degree	36

The highest total in each dimension are the following: female (189), forty years old (119), printed modules (105), one to two numbers of children enrolled in S.Y. 2020-2021 (157), and college (206).

Table 3. Level of parental engagement employed by parents.

Variable	Mean	Std Dev	Implication
Parent Engagement	3.03	0.80	High Parental Engagement
Facilitating	2.99	0.71	
Instructing	3.03	0.78	
Organizing	3.07	0.78	

The parent's level of parental engagement employed during the learning of their children was found to be high, having a mean of 3,03. Among the dimensions, Organizing has the most significant mean having 3.07 and a standard deviation of 0.78. With this, it can be implied that parents have high parental engagement. Also, its dimension will be fatherly discussed below.



Table 4. Level of psychological antecedent employed by parents.

Variable	Mean	Std Dev	Implication
Psychological Antecedent	2.02	0.99	Moderate Psychological antecedent
Avoidance	2.44	0.28	
Aggression	1.83	0.21	
Stigma	1.89	0.26	

Parent's level of psychological antecedent resulted to have a mean of 2.02 and a standard deviation of 0.99. Thus, parents don't always tend to portray negative behaviour to their children. This implies that parents have moderate psychological antecedent towards the modular learning of their children.

Significance of relationship between the Psychological Antecedent of parents and their Parental Engagement

Table 5. Relationship between the Psychological Antecedent; Avoidance, Stigma and Aggression of parents and their Parental Engagement; Facilitating, Instructing and Organizing

Parental Engagement	Psychological Antecedent					
	Avoidance		Stigma		Aggression	
	r-value	Description	r-value	Description	r-value	Description
Facilitating	.164	Weak Correlation	.299	Moderate Correlation	.318	Moderate Correlation
Instructing	.243	Weak Correlation	.276	Weak Correlation	.270	Weak Correlation
Organizing	.268	Weak Correlation	.260	Weak Correlation	.240	Weak Correlation

The computed Pearson correlation for the parent's Psychological Antecedent and their Parental Engagement shows a positive significant relationship. Thus, rejecting the null hypothesis since the p-value is lesser than the level of significance which has a value of 0.01. Multiple regression analysis was also used to test what predicts the Parental Engagement of Parents.

Figure 1. Normal P-P Plot of Regression Standardized Residual of Parental Engagement in terms of Facilitating

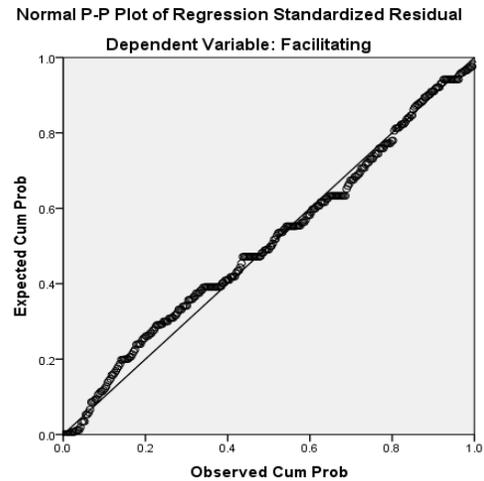

$$\text{Facilitating} = 2.486 + \text{Remote Learning Modality} (.115) + \text{Aggression} (.232)$$

A multiple linear regression was calculated to predict facilitating based on demographic profile and psychological antecedents. A significant regression equation was found ($F(2,298) = 21.476, p < .000$), with and R^2 of .355. Participant's predicted facilitating is equal to $2.486 + \text{Remote Learning} (.115) + \text{Aggression} (.232)$.

Figure 2. Normal P-P Plot of Regression Standardized Residual of Parental Engagement in terms of Instructing

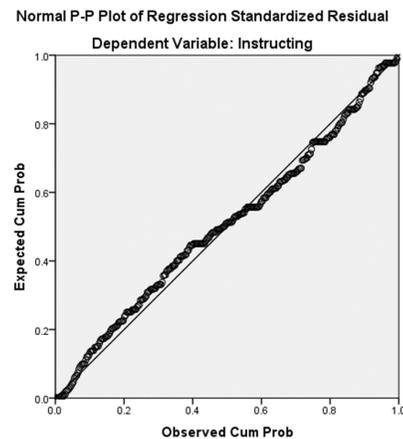



$$\text{Instructing} = 2.235 + \text{Stigma} (.164) + \text{Avoidance} (.110) + \text{Gender} (.140)$$

A multiple linear regression was calculated to predict Instructing based on demographic profile and psychological antecedents. A significant regression equation was found ($F(2,297) = 12.468, p < .000$), with and R^2 of .334. Participant's predicted facilitating is equal to $2.235 + \text{Stigma} (.164) + \text{Avoidance} (.110) + \text{Gender} (.140)$.

Figure 3. Normal P-P Plot of Regression Standardized Residual of Parental Engagement in terms of Organizing

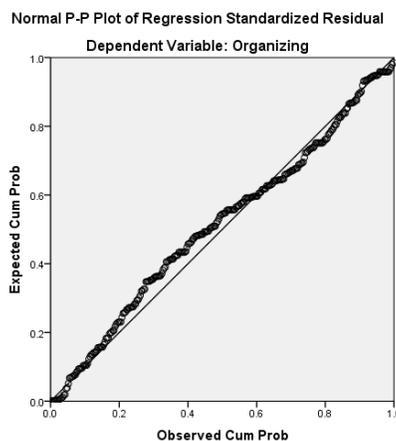

$$\text{Organizing} = 1.987 + \text{Avoidance} (.152) + \text{Remote Learning Modality} (.097) + \text{Gender} (.167) + \text{Stigma} (.136)$$

A multiple linear regression was calculated to predict Organizing based on demographic profile and psychological antecedents. A significant regression equation was found ($F(4,296) = 12.714, p < .000$), with and R^2 of .383. Participant's predicted facilitating is equal to $1.987 + \text{Avoidance} (.152) + \text{Remote Learning} (.097) + \text{Gender} (.167) + \text{Stigma} (.136)$.

Parental engagement in academic activities is particularly significant in this time of the pandemic for students' academic achievement in the remote learning environment in view of the lack of teachers' physical presence. These concerns may stem from the parents' readiness levels. Since the pandemic was so sudden and unsuspected, parents were unprepared for this shift. That is why they would have difficulties balancing their work, home, and teaching responsibilities. Parents were attempting to work remotely or unable to work while caring for children and trying to help them with their education, with no clarity on how long this closure would last. This challenging and uncertain situation could increase the stress level and decrease time management and

planning capacity (Garbe et al., 2020). That makes it necessary to develop a reliable and legitimate parental engagement measurement for research in the remote learning environment.

From the observed data, the Parent's engagement in remote learning towards their children is considered high, having Organizing as the highest mean of 3.07. This means that parents are hands-on and liable to their children's education in terms of facilitating modular learning guides, instructing the tasks needed to be done and learned, and organizing modules and learning environment at home. This result is aligned with the study of Araceli Martinez (2015), who affirms that a rich environment of learning enhances a student's academic development. Consistent stimulation and responsive parenting practices have directly influenced the learner (Toppo et al., 2017).

On the other hand, the parent's psychological antecedent is considered moderate, having avoidance as the highest mean of 2.44 among stigma and ignorance. This implies that in this current study, the parents' psychological behavior has a significant relationship with their parental involvement in their children's education and the parents' demographic characteristics. This also supports the study of Afolabi et al. (2015) study that reported socio-demographic variables (marital status, education, and gender) acts as multiple stressors that weaken the ability and beliefs of parents of learners with inclusive learning on involvement and their contribution to their children's education.

The calculated Pearson Correlation between the parent's Psychological Antecedent and parental engagement reveals a significant positive relationship. Hence, rejecting the null hypothesis because the p-value is below the importance level of 0.01.

Furthermore, regression analysis was used to see what factors influence parental engagement. The predictors for facilitating can account for remote learning modality and aggression as its strongest predictors of facilitation. The predictors towards instructing will account for stigma, avoidance, and gender for its best predictors. Meanwhile, the predictors for Organizing have avoidance, stigma, gender, and remote learning modality as its best predictors.

4. CONCLUSION

It has been acknowledged that the Psychological Antecedent of parents influences changes in their parental engagement in their children's education in terms of their demographic profile. Thus, a positive relationship is shown between them. Likewise, researchers' findings appear that during the implementation of remote learning amidst



pandemic, mechanisms applied (facilitating, instructing, and organizing) are best predicted by parents' demographic characteristics, particularly in gender and children's remote learning modality and parent's psychological antecedent namely stigma, avoidance and aggression. Moreover, parents' behavior of avoidance and aggression are frequently shown as responsive parenting practices, while behaviour of stigma is less involved in execution of parents. Retrospectively, the parent's effort still mutually offers parental engagement in their children's academic activities because education is a vital determinant in their development.

Hence, for further understanding of parent's behavior amidst the COVID-19 pandemic, researchers recommend that future studies can be conducted to compare the role of parent's psychological antecedent in activating a high parental engagement among different groups of remote learning students distinguished by their modality/material used for scholarly activities. Longitudinal study for further research to better measure and display a more practical implication about the parent's behavior towards the virtual school learning environment. Lastly, future researchers may utilize a child's academic attitude, environmental situation, and accessibility of learning materials to induce or influence a parent's psychological antecedent in the remote learning setting.

5. ACKNOWLEDGMENTS

The researchers cannot express enough thanks to all the people that have become a big part of this research study.

First of all, to the Almighty Father Above for giving us the strength and wisdom to start and finish the study;

To our families, our supportive parents, for the patience, full financial and moral support during the making of the study;

To all our friends and classmates, especially to Rozytte Gale C. Imperial, who helped the researchers to make this study as presentable as it is, thank you;

To all the respondents, for all their cooperation that made them a big part of the study;

And most of all to our Advisers, Ms. Kate Anne Ramos, and Mr. Jeovanny Marticion, for all the efforts, exerted in guiding the researchers from the beginning until the very end of the study; a big thank you.

6. REFERENCES

Ali, W., (2020). Online and Remote Learning in Higher Education Institutes: A Necessity in light of COVID-19 Pandemic. *Higher Education Studies*. [Http://DOI:10.5539/hes.v10n3p16](https://doi.org/10.5539/hes.v10n3p16)

- Barbour, M. & Reeves, T., (2016). The reality of virtual schools: A review of the literature. *Science Direct*. <https://doi.org/10.1016/j.compedu.2008.09.009>
- Borup, J., et al., (2013). The nature of parental interactions in an online charter school. *American Journal of Distance Education*. <https://doi.org/10.1080/08923647.2013.754271>
- Clinefelter, D. L., & Aslanian, C. B. (2015). Online college students 2015: Comprehensive data on demands and preferences. *Learning House*. <https://www.learninghouse.com/wpcontent/uploads/2017/09/OnlineCollegeStudents2015.pdf>
- Garbe A., et al., (2020). Parents' Experiences with Remote Education during COVID-19 School Closures. *American Journal of Qualitative research*. <https://doi.org/10.29333/ajqr/8471>
- Gray, J. A. & DiLoreto, M., (2016). The Effects of Student Engagement, Student Satisfaction, and Perceived Learning in Online Learning Environments. *ResearchGate*. https://www.researchgate.net/publication/310672442_The_Effects_of_Student_Engagement_Student_Satisfaction_and_Perceived_Learning_in_Online_Learning_Environments
- Jeynes, W. H., (2005). A meta-analysis of the relation of parental involvement to urban elementary school student academic achievement. *Sagepub Journal*. [https://DOI: 10.1177/0042085905274540](https://doi.org/10.1177/0042085905274540)
- Kauffman, H., (2015). A review of predictive factors of students success in and satisfaction with online learning. *Research in Learning Technology*. <http://dx.doi.org/10.3402/rlt.v23.26507>
- LaVonne, et al., (2015). Graduate students' perceptions of online learning. *ERIC*. <https://eric.ed.gov/?id=EJ1056187>
- Liu, F., et. Al., (2010). The validation of one parental involvement measurement in virtual schooling. *Journal of Interactive Online Learning*. <https://www.ncolr.org/jiol/issues/pdf/9.2.2.pdf>
- McNeal, R. B., (2015). Parent Involvement, Academic Achievement and the Role of Student Attitudes and Behaviors as Mediators. *Semantic Scholar*. <http://DOI:10.13189/UJER.2014>
- Nguyen, T. (2015). The Effectiveness of Online Learning: Beyond No Significant Difference and Future Horizons. *ResearchGate*. https://www.researchgate.net/publication/308171318_The_Effectiveness_of_Online_Learning_Beyond_No_Significant_Difference_and_Future_Horizons
- Ramon, A. D., (2015). The Correlation Between Parental Involvement and Student Academic Achievement. *LSU Master's Theses*. 185. https://digitalcommons.lsu.edu/gradschool_theses/185
- Rice, K. L. (2006). A comprehensive look at distance education in the K-12 context. *JRTE*. <https://doi.org/10.1080/15391523.2006.10782468>
- Russell, G. (2004). Virtual schools: A critical view. In Catherine Cavanaugh (Ed.), *Development and Management of Virtual Schools: Issues and*. IGI Global. [https://DOI: 10.4018/978-159140-154-4.ch001](https://doi.org/10.4018/978-159140-154-4.ch001)
- Stevens, M. & Borup, J. (2015). Parental engagement in online learning environments: a review of the literature. *Mason University. ResearchGate*. [https://DOI: 10.1108/S147936872015000027005](https://doi.org/10.1108/S147936872015000027005)



- Susanto, E., & Suyadi., (2020). The Role of Parents' Attention in the Moral Development of Children in the Amid of COVID-19 Pandemic. *Jurnal Ilmiah Sekolah Dasar*.
<https://ejournal.undiksha.ac.id/index.php/JISD/index>
- Topora, D. R., et al., (2017). Parent involvement and student academic performance: A multiple mediational analysis. ResearchGate.
<http://doi:10.1080/10852352.2010.486297>.
- Waters, L.J., et al., (2014). Parental Involvement in K-12 Online and Blended Learning. *ACM Digital Library*.
<https://dl.acm.org/doi/10.5555/2811036.2811055>
- Susanto, E., & Suyadi., (2020). The Role of Parents' Attention in the Moral Development of Children in the Amid of COVID-19 Pandemic. *Jurnal Ilmiah Sekolah Dasar*.
<https://ejournal.undiksha.ac.id/index.php/JISD/index>



Effects of Personality on Social Status: A Study on Perceived Social Dominance Among Adolescent Single Sex Social Groups

Karol Matthew B. Moreno and Ethan Jason Y. Tanlimco
De La Salle University Integrated School, Manila

Abstract: This study intends to ascertain the relationship between personality traits and perceived social dominance in a peer group setting among Senior High School Students. There are many factors that affect the perceived social dominance of individuals, and so the research aimed to solve which factors these are among the current generation of senior high students. A total of 46 participants answered a google forms survey. It was found that the personalities all had similar measures, such as agreeableness and openness, and conscientiousness and neuroticism. Extroversion gave the most interesting results, with a half and half split for introverted ($f=24$, $\%=52.2\%$) and extroverted ($f=22$, $\%=47.8\%$). It was found that communication ($m=3.24$, $sd=0.85$) and to be there when a friend is needed ($m=3.15$, $sd=0.87$) are the most important domains to peer relationship. Interestingly, there is no statistical relationship between age ($x^2=4.67$, $p=0.197$), and gender ($x^2=0.186$, $p=0.666$) with perceived social dominance. However statistical relationship is established between extraversion measure ($x^2=8.9$, $p=0.003$) and quality of peer relationship ($x^2=4.63$, $p=0.031$) and perceived dominance. The presented evidence warrants assumption that certain personality traits influence social dominance, and it is not related to age, gender, or quality of peer relationships.

Key Words: personality; peer relationship; social dominance; extraversion; adolescent

1. INTRODUCTION

1.1 Background of the Study

There are plenty of dynamics that happen inside social groups. These dynamics often involve the perceived social dominance within a group, or in other words the idea that a certain person is more dominant than other members of an informal group. This phenomenon is known as the Social Dominance Theory. However, what exactly influences the perceived social dominance in a group? Personality was hypothesized to be one of them, and so the researchers decided to make the study revolve around that. Using the Big Five Personalities taken from Soto's (2018) model, wherein the personalities were divided into five categories, extroversion, agreeableness, conscientiousness, neuroticism, and openness. The study in concept is heavily derived from Anderson and his peers' work (2001), wherein they studied which category of personalities affected the social status of certain individuals in a college setting.

The significance of this study is to create a better understanding for people about what exactly affects the relationship between them and their peers in a group. There are not many studies in the Philippines that are similar to this based on what the researchers searched for, so this will provide a good understanding of what the current generation in the Philippines values when looking at the hierarchy of their social groups.

1.2 Statement of the Problem

This study intends to ascertain the relationship between personality traits and perceived social dominance in a peer group setting among Senior High School Students. The following research questions are asked.

1. What is the profile of the respondents?
2. What is the type of personality traits of the respondents?
3. What is the level of quality of peer relationship of the respondents?
4. What is the perceived social dominance of the respondents?



5. What is the relationship of age, gender, personality traits and quality of peer relationship to perceived social dominance?

1.3 Conceptual Framework

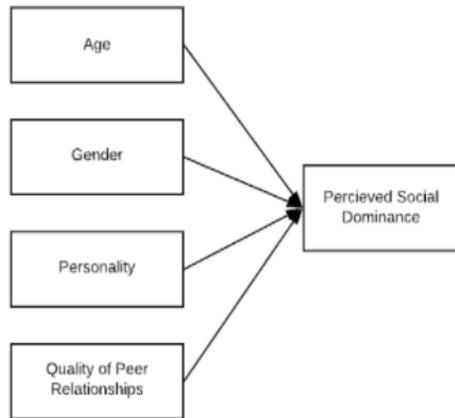

Figure 1: Perceived social dominance in peer groups.

The conceptual framework is meant to display the thought process for what the researchers aim to achieve. The Big Five Personalities, quality of the peer relationships, age, and gender are being used as separate factors that affect the perceived social dominance in a group. A perspective using each of the individual five personalities as well as the overall quality of the relationship between peers in a group and personal information of respondents are used as a basis for determining the perceived social dominance of an individual.

2. METHODOLOGY

2.1 Research Design

The research is going to be making use of a quantitative research design. It will be making thorough usage of the Likert scale for each of the three main variables: personality traits, quality of peer relationships, and perceived social dominance.

2.2 Research Procedure

2.2.1 Sampling

This study intends to use empirical evidence to find the connection between personality traits, peer relationships, and the perceived social dominance among Senior High School students of De La Salle

University Integrated School in single-sex informal groups. A criteria was made to ensure that all of the respondents are what is needed to gain the needed results. The following are the selection criteria:
 Senior High School Grade 12 from De La Salle University Integrated School
 Enrolled in De La Salle University Integrated School
 Belongs to a friend group which is either all male or all female
 Belongs to a group with at least three (3) members.

2.2.2 Instrumentation

The first section is a simple profile survey. It will contain personal and educational information that is needed by the researchers. The following three tests make use of a five point Likert scale. The Big Five personality test used was designed and used by Goldberg(1992) in his study "The Development of Markers for the Big-Five Factor Structure", a psychological assessment which measures an individual's level of personality. The test to measure the quality of peer relationship among the respondents, Terzian's (2012) assessing peer relationship test was adopted and modified, which is meant to assess the bond between two individuals, and thus has been chosen to determine the quality of peer relationship in the group. A perceived social dominance test was constructed which adopted and modified the SDO-7 Scale by Ho et al. (2015)t to fit the background of the participants. In each item, a statement is mentioned concerning whether or not they are in support of the question.

2.2.3 Data Gathering Procedure

The data gathering process was divided into five major steps: participant recruitment, securing informed consent, sharing the link to the google survey forms, the audit of the individual responses, and data preparation for statistical analysis.

2.2.4 Data Analysis

Descriptive statistics was utilized to provide demographics, measure of peer relationship, and perceived social dominance. Kruskal Wallis test was utilized to ascertain statistical relationship between age, gender, and personality trait to perceived social dominance. While Spearman Rho test was utilized to ascertain statistical relationship between quality of peer relationship and perceived social dominance.

2.2.5 Ethical Considerations

This study complied with the ethical guidelines set by the De La Salle University Integrated School and the De La Salle University Research Ethics Office, which includes securing informed consent and voluntary participation.



3. RESULT AND DISCUSSION

3.1 Data Analysis

3.1.1 Profile of the Respondents

Most of the respondents are between the ages of 17 and 18 years, with a large number coming from HUMSS strand. There is almost an equal number of male and female participants.

Table 1: Personal and Educational Characteristics of the Participants

Profile	f	%		f	%		f	%
Age			Sex			Strand		
16	1	2.2	Male	25	54.3	ABM	8	17.4
17	25	54.3	Female	21	45.7	STEM	14	30.4
18	19	41.3				HUMSS	24	52.2
19	1	2.2						

The majority of the participants are 17 years old (f=25, f%=54.3%) and 18 years old (f=19, f%=41.3%). There are slightly more male (f=25, f%=54.3%) than female participants (f=21, f%=45.7%). As for the educational profile of the respondents, a majority were from the HUMSS (f=24, f%=52.2%), while the remaining number come from ABM (f=8, f%=17.4%) and STEM (f=14, f%=30.4%). The large number of HUMSS students participating was a result of the researchers being able to contact more students from the said strand.

3.1.2 Personality Test

All personalities with the exception of extroversion showed very contrasting results, with the respondents leaning towards one than the other, with the exception of extroversion, which showed a somewhat clear split.

Table 2: Personality Test Result

Personality	f	%		Conscientiousness	f	%
Extroversion				Non-Conscientious	13	28.3%
Introverted	24	52.2%		Conscientious	33	71.7%
Extroverted	22	47.8%		Neuroticism		
Agreeableness				Neurotic	40	87.0%
Not Agreeable	1	2.2%		Low-Neuroticism	6	13.0%
Agreeable	45	97.8%		Openness		
				Not open	1	2.2%
				Open	45	97.8%

There is an almost equal distribution on the extroversion result of the participants of the study: introverted (f=24, f%=52.2%) and extroverted (f=22, f%=47.8%), indicating that the generation of the De La Salle University Integrated School Senior High School students were roughly equal in numbers between introverted and extroverted people. This contrasts strongly with the results of the remaining personalities. Neuroticism has more high neuroticism (f=40, f%=87.0%) than low neuroticism (f=6, f%=13.0%). Similar results are found for conscientiousness wherein there are more conscientious people (f=33, f%=71.7%) than not conscientious people (f=13, f%=28.3%). This indicates that there is a notable amount of the minority, but it is not so drastic that it can be considered an equal distribution as extraversion/introversion is. The respondents were considerably more likely to be neurotic and/or conscientious than not. Openness and agreeableness showed results that were almost unanimous, with being open and agreeable (f=45, f%=97.8%) being an overwhelming majority as compared to not being not open and not agreeable (f=1, f%=2.2%). This indicates that it is plausible to call the generation in De La Salle University Integrated School Senior High School "Agreeable" and "Open" based on the data at hand.

3.1.3 Quality of Peer Relationship Test.

The results overall showed that the quality of peer relationship is determined more by the social interactions rather than physical interactions.

Table 3: Quality of Peer Relationship test

Peer Relationship Items	M	SD	Interpretation
Peer Relationship	2.0	0.4	Average
Communicate via social media	3.2	0.8	High
Count on your friend when in need of help	3.1	0.8	High
Visits to friend's house	0.5	0.8	Low

The results suggest that the main thing that keeps the relationship among the respondents and their peers is emotional support, and it is maintained mainly through the use of online resources. However, it should be noted that the study takes place during the pandemic, and so relationships between peers



have been drastically affected due to being unable to go out of their home. This takes form in the high measure on communication and interaction through social media and low measure on going to each other's houses and interactions outside of home. Interestingly, friendships are not held together by having good relations, as evidenced by the low report on it. It could likely be a result of a presence of dominance in the group.

3.1.3 Social Dominance Order Test

The table below details the results of the reactions of the respondents to each of the questions pertaining to social dominance. It all averaged out to "fair", however the values themselves were quite spread out, with statements pertaining to perceiving oneself as the leader of the group being higher in value than others.

Table 4: Social Dominance Order test

Social Dominance Order Items	M	SD	Interpretation
Social Dominance Order	2.64	0.73	Fair
<i>Assumes to be the leader of the group</i>	2.83	1.27	Fair
<i>has high level of influence towards friends</i>	1.96	0.94	Fair
<i>Exerts more authority</i>	3.22	1.15	Fair
<i>Exerts influence and change friend's opinion</i>	3.11	1.14	Fair
<i>Keeps friendship in-tact</i>	3.30	1.11	Fair
<i>Believes to be the leader of the group</i>	2.37	1.22	Fair
<i>Believes they have the most respect in the group.</i>	2.70	0.89	Fair
<i>Believes in the existence of hierarchy in group</i>	1.67	1.01	Fair

A deeper examination of the table shows the dynamics of the generation represented by the participants as to have lower emotional stability and to have higher levels of insecurity. Social relationships are observed to be valued as items regarding their relationships with their peers are located in the top 3 highest scored items. The data on their views of their leadership and authority over their peers also reflect their neurotic personalities, the best example of this would be their high levels of beliefs over their authority but only believing that the influence over them to be minimal.

3.2 Interpretation of the Results

3.2.1 Participant's Profile and Perceived Social Dominance

Based on the results, the gender, age, and strands hold no effect on the perceived social dominance within the group. Likely due to the way the current generation maintains their relationships.

3.2.2 Personality Trait and Perceived Social Dominance

Observations from the researchers conclude that the more extroverted and outgoing an individual is, the more likely they are to be held and recognized by their peers as their leader. While such results may differ from each generation, This result could have been caused by the more social personality of those classified as Generation Z. Extroverted individuals are more likely to initiate conversations giving them the opportunity to strengthen their relationships and allow their peers to get to know more about these extroverted individuals. Furthermore, Similar to the results of Anderson and Shikaro (2008). By attracting more attention to themselves, Extroverted individuals could gather the focus of their peers and allow themselves to have their opinions and ideas heard by the plenty. While another possibility for this connection could be because of the ability for extroverted individuals to initiate outings and take responsibility for deciding for the group, no such data was obtained from the personality of Neuroticism.

3.2.3 Peer Relationship and Perceived Social Dominance

A spearman rho correlation was conducted to ascertain the correlation between the variables of Peer Relationships and Social dominance order. The results suggest that there is a significant correlation among people who maintain a good quality of peer relationships and people who do not ($p=0.031, x^2=4.63$). An interpretation of this would be that an extroverted personality may increase the chances of an individual to reach out and maintain a relationship among his peers. This resulting



correlation may be an extension of the extroversion personality's effects on an individual's dominance.

4. CONCLUSIONS

In conclusion, gender, age, and quality of peer relationships are not relevant to the perceived social dominance. Rather, certain personality traits had a significant correlation with one's status. Furthermore, higher extraversion was discovered to positively influence the levels of their perceived dominance levels ($p=0.003$, $\eta^2=8.99$).

5. RECOMMENDATIONS

The researchers suggest a more comprehensive study with a wider and more diverse sample. Adjustments of the scope used in this study is also hypothesized to change the results significantly due to the different background and participants. Additionally, a blend of quantitative and qualitative may be beneficial so as to understand the rationale behind the thinking of certain respondents that may aid in analyzing the statistical data.

6. ACKNOWLEDGMENTS

The researchers would like to express gratitude to their adviser, Dr. Crisanto Q. Regadio Jr, for guiding them throughout the study. They would also like to express their thanks to all of the participants who took time out of their day to answer it, especially to those who connected the researchers to more respondents.

The researchers also give their special thanks to their Practical Research teachers, Sir Mark Anthony Dacela and Miss Thelma Mingoa for aiding in the early conceptualization of the study's topic.

7. REFERENCES

- Anderson, C., John, O. P., Keltner, D., & Krings, A. M. (2001). Who attains social status? Effects of personality and physical attractiveness in social groups. *Journal of Personality and Social Psychology*, 81(1), 116–132. doi:10.1037/0022-3514.81.1.116
- Anderson, C, & Shirako, A. (2008). Are individuals' reputations related to their history of behavior? *Journal of Personality and Social Psychology*, 94, 320-333.
- Goldberg, L. R. (1992). The development of markers for the Big-Five factor structure.. *Psychological Assessment*, 4(1), 26–42. doi:10.1037/1040-3590.4.1.26
- Ho, A. K., Sidanius, J., Kteily, N., Sheehy-Skeffington, J, Pratto, F., Henkel, K. E., Foels, R., & Stewart, A. L. (2015). The nature of social dominance orientation: Theorizing and measuring preferences for intergroup inequality using the

new SDO7 scale. *Journal of Personality and Social Psychology*, 109(6), 1003-1028.

Soto, J. C. (2018). Big Five Personality Traits. *Journal of Personality and Social Psychology*.

Terzian, Mary A. (2012). Assessing Peer Relations: A Guide for Out-of-School Time Program Practitioners. *Child Trends*.



Pre-Medicine Program as a Factor Influencing Residency Specialization Options of Pre-Medicine Students of University of Perpetual Help System Delta – Las Piñas Campus

Kisses P. Eusebio, Geram M. Mugol, Yuri Louis N. Taduran, Lian Mei S. Terania, Phoemela Crystal G. Tumala and Gwyneth Ardee E. Villalino
University of Perpetual Help System DALTA, Las Piñas City

Abstract: Pre-medicine program is the first step on one’s medical journey. Choosing the best pre-medicine program may give one prerequisite skill that are likely needed during medical school as well as in residency training. Different programs offer different subjects and competencies to meet, so it gives several advantages and disadvantages for the student with respect to their performance in medical school and residency training. This leads researchers to think that choosing the right pre-medicine program is crucial to be competent enough in the professional field. The study is conducted to know if there is a significant relationship between the chosen pre-medicine program and residency specialization options of pre-medicine students of University of Perpetual Help System DALTA - Las Piñas Campus. In order to find answers to this, the researchers conducted a semi-unstructured interview on 10 pre-medicine students of UPHSD that are categorized into two categories: 5 for BS Nursing and 5 for BS Medical Technology, via MS Teams or Messenger call. The results showed that respondent’s current pre-medicine program does not affect their specialization options. Most of them did not have a hard time choosing their current pre-medicine program since it is their already their top choice without considering specialty. They reasoned out that pre-medicine program is independent from the residency training itself. The researchers concluded that there is no significant relationship between pre-medicine program and residency specialization options of pre-medicine students of UPHSD – Las Piñas Campus.

Key Words: pre-medicine program; residency specialization; medical school; nursing; medical technology

1. INTRODUCTION

The field of medicine requires adequate competencies in order to rightfully serve the duty it partakes, given the fact that medical professionals basically hold a patient’s life on a daily basis. Along with this is the time it consumes to finally enter the field, as well as the several choices that one can encounter throughout its medical journey. This will all begin on choosing the most suitable pre-medicine program in order to earn an undergraduate degree that is required upon entering a medical school.

“There is not actually a major called ‘pre-med’; pre-med is just a term to let people know you have plans to be a doctor” (Sakiras, 2020). While it is actually true, it is important to have a clear goal in mind because “It is a vocation as much as it is a learning experience” (Mapa, 2018). Without entering medical school, a pre-medicine program is a career by itself which opens work opportunities if by any chance that one will not proceed to get a medical degree.

Weighing specialization options is one of the major decisions that a medicine student should look

thoroughly before coming to the professional field. Pre-medicine program greatly sets medicine student’s future in that field of specialization as their knowledge and several skills acquired upon taking this will determine how well they can perform as a resident and eventually, as a doctor (Pan Afr Med J. et al, 2014).

Various pre-medicine program gives upcoming medicine students prerequisite skills in preparation for their medical journey. According to Mappa (2020), skills like scientific processing, analytical thinking, problem solving, and memorizing well is vital for a medicine student. Since different program have different sets of subjects to take as well as competencies to meet, they all have their edge over one another. Thus, choosing the right pre-medicine program help students to perform better upon choosing specialization in residency training that may affect their future, especially into that profession in which they wish to be proficient in.

This study may benefit aspiring doctors who are still in high school, pre-medicine students and, mostly, medical students, since they are already one



step away in taking their residency. Moreover, this study can generate information and recommendations that can be used to respond to the challenges of choosing the most suitable pre-medicine program which would ideally help them excel in residency training as well as in the actual professional field.

This aims to know if there is a significant relationship between the chosen pre-medicine program of pre-medicine students of University of Perpetual Help System DALTA – Las Piñas Campus and their residency specialization options. It also aims to give high school students an idea on what pre-medicine program suits them best based on their residency preference, if they already have one in mind. Ultimately, to produce medicine students that can excel in their residency training as well as medical professional who have the competencies to better serve the nation.

2. METHODOLOGY

The researchers decided to do a survey-interview as their data gathering tool, specifically a semi structured type of interview, that refers to an interview concept that does not strictly follow a formalized list of questions. With this the researchers have prepared at least 7 questions to be given to the interviewee. As it allows for a discussion with the interviewee rather a straightforward question and answer format.

2.1 Data Gathering tool

The researchers decided to do a survey-interview as their data gathering tool, specifically a semi structured type of interview, that refers to an interview concept that does not strictly follow a formalized list of questions. With this the researchers have prepared at least 7 questions to be given to the interviewee. As it allows for a discussion with the interviewee rather a straightforward question and answer format.

2.2 Sampling Design/Respondents

The sampling that will be used in the study is stratified random sampling. Respondents will be categorized based on the pre-medicine program that they took mainly BS Nursing, BS Medical Technology. From a population of 10 students, the researchers will only get 5 respondents per category which will sum up to 10 respondents as the sample.

2.3 Data Gathering Procedure

The researchers will be using a one-on-one interview for collecting the data from respondents. One researcher will be assigned per correspondent. The researcher will be recording the phone call to document the interview process. The length of the

interview process that has taken place was around 8 minutes at max.

2.4 Data analysis Plan

The researcher will be using descriptive statistical tools, specifically the measures of central tendency to analyze the data that was gathered. It enables the researchers to summarize the statistic that quantitatively describes or summarizes features from a collection of the said information and enables to evaluate, and interpret how the respondents will answer the asked questions. Therefore, through the evaluated data the researchers will be able to generate conclusions that will answer the research questions from the overall topic. With this method, it will show the average based on the questions asked during the interview. It allows the researchers to describe the response of the respondents if their chosen pre-medicine program will affect their specialization.

3. RESULTS AND DISCUSSION

3.1 What general and specific skills would you hope an ideal pre-medicine course experience would give you?

Figure 1. Did you have a hard time choosing your pre-medicine program?

	BSN	BSMT	f	%
Yes				
Considering what is the easiest program	1	1	2	20%
Too many pre-medicine program choices	0	1	1	10%
Program choice/s shifted due to pandemic	1	0	1	10%
No				
Interest and Top Choice	3	3	6	60%
TOTAL:	5	5	10	100%

Most of the respondents answered no with a frequency of 6 or 60%. While 4 or 40% of the respondents answered yes to the question. most of the respondent's reason for answering no is because a certain pre-medicine program is their interest and top choice, with a frequency of 6 or 60%. While 2 or 20% of the respondent's reason for answering yes is because they are considering the easiest program to take, whether as for pre-medicine or not. One of the respondents had a hard time choosing his pre-medicine since she originally planned that she would take pre-law program be lawyer. But then, after the declaration of COVID-19 pandemic, she decided that she now wanted to pursue BS Nursing. "It is one of the most needed here," she reasoned out.

Most of the respondents answered no with a frequency of 8 or 80% while 2 or 20% of the



Figure 2. Did your choice of pre-medicine program affect your specialization you plan to take?

	BSN	BSMT	f	%
Yes				
Skills and Subjects offered by pre-medicine program	0	2	2	20%
No				
Pre-medicine program is independent from residency specialization	5	0	5	50%
Already have specialization interest	0	3	3	30%
TOTAL:	5	5	10	100%

respondents answered yes. most of the respondent's reason for answering no is because they believed that a pre-medicine program is independent from residency specialization that they want to take, with a frequency of 5 or 50%. While the remaining 2 or 20% who answered yes reasoned out that a pre-medicine program has a set of skills and subjects to offer that can be useful in medical school or upon taking specialization. One of the respondents think that every pre-medicine program that everyone takes can have an effect in choosing a specialization in the future because before someone can have a final choice, he/ she must have gone to a medical school first. She said that some courses are being tackled already, especially in BS Medical Technology that will be taught again in medical school. Example for this is the subject bacteriology.

3.2 What pre-medicine program corresponds to a certain residency specialization?

Table 1. What general and specific skills would you hope an ideal pre-medicine course experience would give you?

	BSN	BSMT	f	%
Through hand-on experiences that the program offers	2	5	7	70%
Through learning adaptability	2	0	2	20%
Through learning communication skills	1	0	1	10%
TOTAL:	5	5	10	100%

Most of the respondents expected several skills that they want to develop including communication skills and critical thinking that will help them provide the right diagnosis with a frequency of 7 or 43.75% and 5 or 31.25% respectively.

Table 2. What qualities do you look for in a pre-medicine course?

	BSN	BSMT	f	%
Yes	4	3	7	70%
No	1	2	3	30%
TOTAL:	5	5	10	100%

Most of the respondents answered adaptability as the quality they look for when they

have chosen their pre-medicine course, given that medicine students can encounter various scenarios in their everyday work, with a frequency of 9 or 60%. While 1 or 6.67% of the respondents answered communication. One on the respondents from BS Medical Technology said that she does not look for the qualities in a pre-medicine program because she wanted pre-medicine that is comfortable and the one that she really likes. "Because regardless of the course, I think that if I really want what I am doing, I can really do something even though it contradicts my attitudes," she added.

3.3 What are the factors being considered by the medicine students in choosing their residency specialization

Table 1. Did you consider Medical School as a factor in your residency specialization?

	BSN	BSMT	f	%
Yes				
Overall quality of the Medical School as means of foundation for future specialization	4	3	7	70%
No				
Not an entire factor for specialization	1	0	1	10%
Multiple factors aside from medical school	0	2	2	20%
TOTAL:	5	5	10	100%

Most of the respondents considered medical school as a factor in their residency specialization with a frequency of 7 or 70% while 3 or 30% of them did not. most of the respondent's reason for answering yes is because they believe that the overall quality of the medical school like reputation and facilities is the foundation of their future specialization, with a frequency of 7 or 70%. While 1 or 10% of the respondents answered that medical school is not a factor in their future specialization. One of the respondents in BS Medical Technology said that at first, she considered medical school as a factor in their residency specialization but after reflecting in our situation we had, she changed her mind.

Table 2. Does your financial status affect your choice of residency specialization?

Factors	BSN	BSMT	f	%
Family	0	3	3	30%
Location of School	0	1	1	10%
Passion	2	1	3	30%
Mental Health	1	0	1	10%
Time	1	0	1	10%
None	1	0	1	10%
TOTAL:	5	5	10	100%



Most of the respondents answered that their choice of residency specialization is affected by their financial status due to it being really expensive to study, with a frequency of 8 or 80%. In contrast to this, 2 or 20% of the respondents answered that their financial status does not affect their choice of residency specialization. One of the respondents think that financial stability will definitely a specialization. She emphasized that, "To be a doctor, it takes many years of education and tuition fees. Other than that, there will be miscellaneous fees and expenses that are included in the tuition." The respondent concluded that if your financial status is not really great, it will definitely have an effect.

Table 3. What other factors did you consider in taking your residency specialization that the researchers did not mention?

	BSN	BSMT	f	%
The influence of Parental suggestion	0	2	2	23%
Influenced by family background	0	1	1	11%
Location of the said institute	0	1	1	11%
Self interest in the program	3	1	4	33%
The given time of completion for finishing the program	1	0	1	11%
None	1	0	1	11%
TOTAL:	5	5	10	100%

Most of the respondents believed that family and passion is what they consider as a factor in taking their residency specialization, with a frequency of 3 or 30%. By passion and family are the two factors considered by the respondents other than the Medical school and their financial statuses. The respondents considered their passion since self-interest is important for them in choosing their specialization. Also, the family, especially the respondent's parental suggestion to them significantly affect their choices.

With the data collected, analyzed, interpreted and presented, the researchers therefore conclude that most of the respondents did not have a hard time choosing their pre-medicine program as most of the respondents answered positively to the question. The respondents' choice of pre-medicine program is based on their interest and their top choice. This is because they believed that a pre-medicine program is independent from the residency specialization that they plan to take. Therefore, pre-medicine programs do not affect the specialization that they are going to take in the future.

4. ACKNOWLEDGMENTS

Sincere gratitude is hereby extended to the following that never ceased in helping for this research paper. Our research teacher, Mr. Wilfred Glenn Catud, and the Senior High School Department for the endless help, guidance and support. For the unwavering support of those people who help and

gives us additional information about our study. Above all, we would to acknowledge our Almighty God for the divine intervention in this academic endeavor.

5. REFERENCES

Aboshady, O., Zenhom, M., & Nasr, A. (2015, November 23). What should medical students do to choose thei specialty. *The Pan African Medical Journal*.
<https://www.ncbi.nlm.nih.gov/pmc/articles/PMC4765349/>

Chang, P.-Y., Hung, C.-Y., Wang, K.-I., & Huang, Y.-H. (2006, July). Factors Influencing Medical Students Choice of Specialty. *ResearchGate*.
https://www.researchgate.net/publication/6983675_Factors_Influencing_Medical_Students%27_Choice_of_Specialty

Dossajee, H., Obonyo, N., & Ahmed, S. (2016, January 11). Career preferences of final year medical students at a medical school in Kenya-A cross sectional study. *BMC Medical Education*.
<https://bmcomeduc.biomedcentral.com/articles/10.1186/s12909-016-0528-1>

Karkowsky, C. (2013, October 31). Third-Year Medical School: Deciding on Your Specialty. *The Doctor's Tablet blog*. <http://blogs.einstein.yu.edu/third-year-medical-school-deciding-on-your-specialty/>

Mapa, B. (2018, October 31). Want To Be a Doctor? Here Are the 7 Best Pre-Med Courses! *Edukasyon.ph*.
<https://portal.edukasyon.ph/blog/want-to-be-a-doctor-here-are-the-best-pre-med-courses>

Medical & Healthcare Courses offered at UPHSD Las Piñas. (n.d). *FIND UNIVERSITY*.
<https://www.finduniversity.ph/universities/university-of-perpetual-help-delta/courses/medical-healthcare/>

Mehmood, S., Kumar, A., Al-Binali, A., & Borleffs, J. (2012, March 12). Specialty preferences: Trends and perceptions among Saudi undergraduate medical students. *Taylor & Francis Online*.
<https://www.tandfonline.com/doi/full/10.3109/0142159X.2012.656753?scroll=top&needAccess=true>

Nicodemus, L., Tabios, I., & Tabios, B. O. (2018, October). Medical Students Career Choices and Perceptions in Family Medicine and Primary Care. *ResearchGate*.
https://www.researchgate.net/publication/328281251_Medical_Students_Career_Choices_and_Per



ceptions_in_Family_Medicine_and_Primary_Care

Sawonik, S., Kazlowiec, M., Kolodynska, A., Domagala, A., Aftyka, Milanowska, J., . . . Samardekiewicz, M. (2019, March 12). Do medical students have problem with choosing the specialty? Preliminary report of the medical students population based study. Sciendo. <https://content.sciendo.com/view/journals/pjph/128/3/article-p115.xml?language=en>

What to Look for When Choosing Pre-Med College Programs. (2017, November 29). Peterson's. <https://www.petersons.com/blog/what-to-look-for-when-choosing-pre-med-college-programs/>



A Review on the Application of Voltammetry in the Determination of Activity of Vitamins and Antioxidants in Fruit Juices

Erika Mae T. Borres, Ashley Mae T. Juan-Sing, Mike Dane A. Pararuan
and Erika Leanne R. Tined

De La Salle University Integrated School, Manila

Dr. Allan N. Soriano,
De La Salle University, Manila

Abstract: Voltammetry is preferred amongst other techniques for antioxidant and vitamin component detection because of its selectivity, sensitivity, ease of access, and inexpensive instrumentation. This study aims to assess and evaluate existing studies revolving around voltammetric determination of vitamins and antioxidants of fruit juices, seeing as they are a rich source of vitamin and antioxidants, to find commonalities and trends over the years. Articles reviewed found differential pulse voltammetry and square wave voltammetry to be the most utilized method for vitamin and antioxidant determination, respectively. Electrode performance was also compared between bare and modified electrodes by comparing the limit of detection (LOD) and recovery rate (RR) of each. A bare electrode was found to have the highest LOD value in vitamin determination, but modified electrodes seemed to display enhanced performance when compared to its bare self. Though, usage of modified electrodes in antioxidant determination displayed a much more distinguishable improvement. Optimal pH value of the supporting electrolyte in vitamins is $5.0 \leq \text{pH} \leq 7.0$, while it was found that the optimal pH value for antioxidants was $2.0 \leq \text{pH} \leq 6.0$. In conclusion, voltammetric determination is highly dependent on the combination of the method, the composition of the electrode, and the pH of the supporting electrolyte solution.

Key Words: voltammetry; vitamins; antioxidants; fruit juices; electrodes

1. INTRODUCTION

Food component detection is essential in ensuring the quality, safety, and nutrition of the food products distributed to the public. Voltammetry is the preferred method for the determination of such due to its cheap instrumentation, excellent sensitivity, rapid analysis, and simultaneous determination (Gulaboski & Pereira, 2008). With that, these methods have proven to be advantageous for analyzing a wide range of compounds found in food and beverages (Pisoschi, 2015). Additionally, these methods are also used to study different interactions between chemical components such as contaminants, antioxidants, and vitamins. Among the vitamins, ascorbic acid (AA) is frequently determined for its reductive and water-soluble properties allowing its participation in various biochemical reactions (see Figure 1).

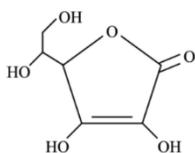

Figure 1. Chemical Structure of Ascorbic Acid

Given that a number of the aforementioned detectable food components with proven electrochemical properties are commonly possessed by fruit juices, voltammetry has been a highly recognized technique used for the said beverage. Fruit juices are associated with health benefits as they are rich sources of antioxidants and vitamins. Both constituents enhance the defense of the body against free radicals by preventing cells from being damaged, making the quantification of such crucial (Leonard et al., 2002).

Methods and electrode compositions were found to be factors that affect the behavior of voltammetric analysis (Pisoschi, 2015). This entailed a considerable number of studies to focus on antioxidant and vitamin determination using various combinations of electrodes and voltammetric methods. With this prominence, this systematic literature review aims to provide an extensive analysis and comparison of the existing literature in order to gauge the current state of voltammetry in food analysis, specifically for fruit juices. Particularly, this paper focuses on investigating its performance in vitamin and antioxidant determination, mainly in terms of the

specific methods, electrodes, and parameters utilized for food component detection in fruit juices. The reviewed literature was limited to research articles which have evaluated the technique solely in fruit juices and were published within the year 2000 to 2021.

2. METHODOLOGY

The Preferred Reporting Items for Systematic Reviews and Meta-Analyses (PRISMA) guidelines was utilized for the data collection procedure of the study, with records identified from two scientific databases, i.e., ScienceDirect and Scopus, using the keywords “voltammetry” AND “fruit juices”. A total of 38 articles was formally included in the review as seen in Figure 2; however, only the section of the original manuscript, which solely focuses on voltammetric applications in vitamin and antioxidant determination, was presented in this paper. Particularly for the said focus, only 20 articles were reviewed.

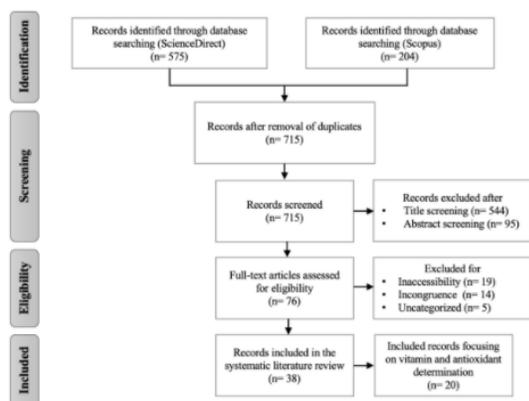

Figure 2. Adapted PRISMA Diagram Used in the Study

The extracted data from each study included the method of determination, performance of the electrode, and parametric study of pH employed in vitamin and antioxidant analysis. For electrode performance, the limit of detection (LOD) and recovery rate (RR) were also included for further examination of the effectiveness of the electrodes in fruit juice samples. The data obtained for each aspect were tabulated and sorted, depending on the availability and pertinence of the variables for examination. Common trends and outliers on the prevalence of particular voltammetric techniques, effects of electrode modifications, and optimal pH levels for supporting electrolytes were identified. Possible developments and researches on less covered areas of the field of study were also established.

3. RESULTS AND DISCUSSION

3.1. Method of Determination

As seen in Figure 3, Differential Pulse Voltammetry (DPV) is the most exploited method in vitamin determination, specifically AA, due to its exemplary precision, sensitivity, and speed. It can detect micromolar amounts of chemical components, making it convenient for detection in low concentration samples (Abdelrahim et al., 2013). Verifying its accuracy, most studies have found that the acquired AA levels corresponded with the reference data obtained from the standard titration methods (Ijeri et al., 2001; Gopalakrishnan et al., 2018; Gheibi et al., 2013). This congruence implies that DPV is comparable to the performance of conventional techniques and can be used as a reliable alternative.

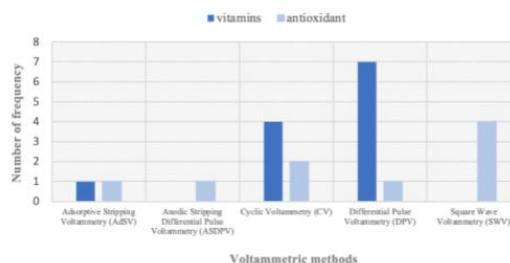

Figure 3. Usage Frequency of Voltammetric Methods Among Reviewed Literature

Despite the existence of successful studies utilizing other electrochemical techniques such as CV and AdSV, most of the reviewed literature found DPV to be more advantageous than others due to its higher current sensitivity, better resolution, and capability to eliminate capacitive charging currents (Gheibi et al., 2013; Intarakamhang et al., 2011). Hence, it can be concluded that DPV is the most suitable voltammetric technique for AA determination.

Voltammetric methods CV, DPV, and AdSV were also found to be applicable in quantifying antioxidants. However, unlike CV that was regarded by Bordonaba & Terry (2012) as the usual method choice in antioxidant analysis, further research utilizing DPV and AdSV is necessary for an in-depth establishment of their usefulness for the said purpose. SWV was observed to be the most applied in antioxidant determination due to its superior detection performance compared to conventional methods (see Figure 3). No interference was reported in polyphenol detection, unlike the traditional colorimetric method (Abdel-Hamid & Newair, 2016). SWV was also observed to perform better than CV in antioxidant assays. This technique exhibits the best characteristics of several voltammetric methods



which, besides sharing similar advantages with CV, includes easy identification of reversible oxidation reaction and easy obtainment of redox peaks (Bordonaba & Terry, 2012). These findings substantiate the effectiveness of SWV as the most favored method for antioxidant determination. Descriptions, advantages, and disadvantages of each method were summarized in Table 1.

Table 1. Summary of Voltammetric Techniques and Functions

Technique	Description	Advantage	Disadvantage
CV	Studies electrochemical behaviors and relationships	Provides easy qualitative analysis	Average quantitative analysis
SWV	Evaluates electrode kinetics and mechanisms	Fast and sensitive pulse technique	Low currents from irreversible systems
DPV	Discriminates Faradaic currents with small pulses	Rapid analysis and good selectivity	Slower than SWV
AdSV	Spontaneously strips and absorbs species on the electrode's surface	Detects low concentrations	Prone to interferences

3.2. Comparison of Electrode Performance

Among the studies reviewed, carbon paste electrode (CPE) is the most exploited working electrode, especially in older studies (Intarakamhang et al., 2011; Tadese et al., 2014; Pisoschi et al., 2011). However, modification of electrodes in more recent studies was observed to become more prevalent. All reviewed literature reported that modifications have yielded sharpened electrode performances. Abdel-Hamid and Newair (2016) applied PGA/MWCNT/GCE for gallic acid (GA) determination and has proven its capability to enhance electrode kinetics and GA oxidation. Frequently used modified screen-printed carbon electrodes (SCPEs) have also shown great performance for detecting both antioxidants and vitamins, as these were found to be capable of preventing phenolic coupling-induced electrode deactivation which results from polymeric film formation, a common problem in electrochemistry (Bordonaba & Terry, 2012). This corresponded to that of Gopalakrishnan et al. (2018), which emphasized the advantage of CdO/SPCE over other electrodes in terms of reproducibility, selectivity, and sensitivity. Generally, these substantiate the prominent observation that modifications made for bare solid electrodes is an effective factor that enhances electrode performance. Hence, there is a large potential for further exploration and development of modified electrodes to bring forth new benefits for voltammetry in vitamins and antioxidant determination.

Effects of electrode modification on its performance were further investigated by comparing the LODs and the RRs obtained from spiked fruit juice (see Table 2). Among the studies utilizing CPE for AA determination, a lowest LOD value of 2.2×10^{-11} M with an RR of 93.4%-105% was acquired by Tadese et

al. (2014), when paired with CV. Presently, this electrode-method combination is found to be the most promising and effective for AA determination amidst the development of new modified electrodes. The CdO/SPCE used with DPV has exhibited superior performance with an LOD of 5.4×10^{-8} M and an RR of 98.6% over CPEs utilized with the same method (Gopalakrishnan et al., 2018). Despite the establishment of CPEs over other electrodes, there is still no apparent reason behind its prevalence for AA determination. Although a range of 99.9%-101% was found to be closest to the ideal rate of 100%, a significant difference in LOD values were observed when utilized alongside DPV. Hence, not completely establishing the highest degree of sensitivity (Intarakamhang et al., 2011); this could possibly be attributed to its suitability in the specific sample.

Table 2. Electrode Performance in Determination of Vitamins and Antioxidants in Juices

Method	Component	Working Electrode	Limit of Detection (M)	Recovery Rate (%)	Reference
DPV	AA	CdO/SPCE	5.4×10^{-8}	98.6	Gopalakrishnan et al. (2018)
CV	AA	Pt	9.0×10^{-4}	94.4-104	Pisoschi et al. (2008)
DPV	AA	AuSNPs/CeO/SNGC	2.9×10^{-6}	88.8-108	Abdelrahim et al. (2013)
DPV	AA	CPE	5.0×10^{-5}	99.9-101	Intarakamhang et al. (2011)
CV	AA	CPE	2.2×10^{-11}	93.4-105	Tadese et al. (2014)
CV	AA	Pt	7.5×10^{-5}	94.9-103	Pisoschi et al. (2011)
CV	AA	CPE	1.8×10^{-5}	95.1-105	Pisoschi et al. (2011)
DPV	AA	CPE	2.0×10^{-5}	94.9-103	Pisoschi et al. (2011)
DPV	AA	Pt	8.7×10^{-6}	94.7-105	Pisoschi et al. (2011)
DPV	AA	CuO/GCE	1.0×10^{-6}	96.3-105	Buledi et al. (2020)
DPV	Rutin	GCE	1.0×10^{-7}	105.8	Blasco et al. (2004)
SWV	Rutin	CoFe ₂ O ₄ NPs/ILs/CPE	3.0×10^{-11}	97.6-102	Yola et al. (2017)
SWV	GA	PGA/MWCNT/GCE	3.2×10^{-6}	101	Abdel-Hamid & Newair (2016)
AdSV	Quercetin	BDDE	4.4×10^{-10}	94.7-106	Abdullah et al. (2018)
ASDPV	Quercetin	PGE	3.0×10^{-10}	93.2-94.7	Vu et al. (2015)

*CdO/SPCE - cadmium oxide screen-printed carbon electrode; AuSNPs/CeO/SNGC - gold-studded cerium oxide nanoparticles modified sonogel-carbon material; CuO/GCE - copper oxide nanoparticles modified glassy carbon electrode; GCE - glassy carbon electrode; CoFe₂O₄NPs/ILs/CPE - CoFe₂O₄ nanoparticles ionic liquid nanocomposite modified carbon paste electrode; PGA/MWCNT/GCE - poly(gallic acid)/multiwalled carbon nanotube modified electrode; BDDE - boron-doped diamond electrode; PGE - pencil-graphite electrode

In contrast to AA determination, a significant difference in electrode performance between the bare GCE and modified electrodes was observed. The CoFe₂O₄NPs/ILs/CPE utilized with SWV for rutin determination had an LOD value of 3.0×10^{-11} M and RR of 97.6%-102%, and exhibited superior electrode performance among all electrodes used for antioxidant detection (Yola et al., 2017). Meanwhile, a relatively higher LOD value of 1.0×10^{-7} M and deviated RR of 105.8%, were observed for the bare GCE (Blasco et al., 2004). Generally, these still validate how electrode modifications can increase its performance; however, it can be speculated that electrode-method relationships could be a factor that induces the slight discrepancy observed in the determination of AA.



3.3. Parametric Study of pH on Electrochemical Determination

Optimal electrolyte pH is a common parameter that was investigated by several studies (see Table 3). For AA detection, Tadese et al. (2014) investigated the effect of pH using CV and CPE, where the optimal pH value obtained was at pH 5.0. This suggests that using an electrolyte with a slightly acidic pH is favorable for AA determination using the given electrode. Meanwhile, Gheibi et al. (2013) assessed the effect of pH on peak currents and peak potentials in AA determination using APMCNTPE and obtained a rather neutral optimal value at pH 7.0. Despite the discordance of the aforementioned studies, it was found that AA in apple juice can also be determined at a pH level of 6.9 as utilized with a AuSNPS/CeO/SNGC, which directly falls between the optimal values mentioned prior (Abdelrahim et al., 2013). Although some researches have also utilized highly acidic electrolytes at a pH range 1.5-3.5, such levels of acidity come as a minority (Yilmaz et al., 2008; Ijeri et al., 2001). Hence, it can be concluded that AA is preferably determined using acidic electrolytes, commonly within a pH range of 5.0-7.0.

Similarly, several studies have also established optimal pH levels for antioxidant determination; all of which were also observed to be at an acidic range. Abdullah et al. (2018) investigated the redox behavior of quercetin using AdSV with a BDDE; its optimal pH is found to be at an acidic range with the pH levels of 2.0-5.0. Additionally, there are a number of studies that observed optimal pH values that fall within the said range. General polyphenol detection was obtained using highly acidic electrolytes at pH 2.6 using PGA/MWCNT/GCE, while ellagic acid (EA) and rutin were determined with electrolytes with a higher pH value of 5.5 and 6.0, respectively (Abdel-Hamid & Newair, 2016; Cuartero et al., 2011; Yola et al., 2017). It is evident that an abundant number of studies determine antioxidants at a pH range of 2.0-6.0; hence concluding that antioxidants in fruit juices are favorably determined with an acidic supporting electrolyte, regardless of the electrode used.

Table 3. Obtained Optimum pH Values

Method	Component	Working Electrode	Optimal pH Value	Reference
CV	AA	APMCNTPE	7.0	Gheibi et al. (2013)
DPV	AA	AuSNPS CeO/SNGC	6.9	Abdelrahim et al. (2013)
CV	AA	CPE	5.0	Tadese et al. (2014)
DPV	AA	GCE	3.5	Yilmaz et al. (2008)
DPV	AA	CPE	1.5	Ijeri et al. (2001)
SWV	Rutin	CoFe ₂ O ₄ /NPs/ILs/CP E	6.0	Yola et al. (2017)
SWV	GA	PGA/MWCNT-GCE	2.6	Abdel-Hamid & Newair (2016)
SWV	EA	GCE	5.5	Cuartero et al. (2011)
SWV	Rutin	GCE	6.0	Cuartero et al. (2011)
AdSV	Quercetin	BDDE	2.0-5.0	Abdullah et al. (2018)
ASDVP	Quercetin	PGE	3.0	Vo et al. (2015)
CV	Phenol	Pt	3.0	Pijac-Zegarac et al. (2009)

*APMCNTPE - p-aminophenol modified carbon nanotubes paste electrode

4. CONCLUSIONS

Voltammetry has proven to be an effective technique for antioxidant and vitamin determination in fruit juices. The performance of the technique was found to be highly dependent on the specific voltammetric method, electrode, and optimal pH of the electrolyte used. For vitamin determination, DPV is the most utilized due to its exceptional sensitivity and resolution. Despite a bare electrode exhibiting the best LOD value for AA determination, enhancements in performance in modified electrodes were still observed. As for the studied parameter, enhanced selectivity was also displayed when utilizing pH at slightly acidic to neutral levels. Meanwhile, antioxidant detection favored SWV because of its superior performance. Unlike in vitamin determination, there is a distinct improvement in performance of modified electrodes in contrast to the one with a considerable RR. The optimal pH of the supporting electrolyte for better selectivity was found to be at generally acidic levels. It can be concluded that the performance of voltammetry in detecting components in fruit juices may be further improved by ascertaining the compatibility of the method, electrode, and the pH of the electrolyte solution with one another. Further studies for thorough investigation between method-electrode modification relationships are also recommended.

5. ACKNOWLEDGMENTS

First and foremost, we would like to thank De La Salle University Integrated School for giving us the opportunity to further hone our skills in research and in the field of STEM. This has truly been an experience that we will bring as we continue to reach our personal aspirations.

We would also like to extend our sincerest gratitude to our research supervisor, Dr. Allan N. Soriano from the Chemical Engineering Department of the Gokongwei College of Engineering, De La Salle University for his invaluable guidance and support throughout this research. Without his patience and understanding, the completion of this research would not be possible.

Above all, we would like to thank God Almighty for blessing us with the perseverance and commitment which have truly guided us in accomplishing this paper amidst the ongoing pandemic.

6. REFERENCES

Abdel-Hamid, R., & Newair, E. F. (2016). Voltammetric determination of polyphenolic content in pomegranate juice using a poly (gallic acid)/multiwalled carbon nanotube modified



- electrode. *Beilstein Journal of Nanotechnology*, 7, 1104–1112. <https://doi.org/10.3762/bjnano.7.103>
- Abdelrahim, M., Benjamin, S., Cubillana-Aguilera, L., Naranjo-Rodríguez, I., de Cisneros, J., Delgado, J., & Palacios-Santander, J. (2013). Study of the Electrocatalytic Activity of Cerium Oxide and Gold-Studded Cerium Oxide Nanoparticles Using a Sonogel-Carbon Material as Supporting Electrode: Electroanalytical Study in Apple Juice for Babies. *Sensors*, 13(4), 4979–5007. <https://doi.org/10.3390/s130404979>
- Abdullah, A. A., Yardım, Y., & Şentürk, Z. (2018). The performance of cathodically pretreated boron-doped diamond electrode in cationic surfactant media for enhancing the adsorptive stripping voltammetric determination of catechol-containing flavonoid quercetin in apple juice. *Talanta*, 187, 156–164. <https://doi.org/10.1016/j.talanta.2018.05.016>
- Baś, B. I., Jakubowska, M. I., & Górski, Ł. (2011). Application of renewable silver amalgam annular band electrode to voltammetric determination of vitamins C, B1 and B2. *Talanta*, 84(4), 1032–1037. <https://doi.org/10.1016/j.talanta.2011.03.006>
- Blasco, A. J., González, M. C., & Escarpa, A. (2004). Electrochemical approach for discriminating and measuring predominant flavonoids and phenolic acids using differential pulse voltammetry: towards an electrochemical index of natural antioxidants. *Analytica Chimica Acta*, 511(1), 71–81. <https://doi.org/10.1016/j.aca.2004.01.038>
- Bordonaba, J. G., & Terry, L. A. (2012). Electrochemical behaviour of polyphenol rich fruit juices using disposable screen-printed carbon electrodes: Towards a rapid sensor for antioxidant capacity and individual antioxidants. *Talanta*, 90, 38–45. <https://doi.org/10.1016/j.talanta.2011.12.058>
- Buledi, J. A., Ameen, S., Khand, N. H., Solangi, A. R., Taqvi, I. H., Agheem, M. H., & Wajdan, Z. (2020). CuO Nanostructures Based Electrochemical Sensor for Simultaneous Determination of Hydroquinone and Ascorbic Acid. *Electroanalysis*, 32(7), 1600–1607. <https://doi.org/10.1002/elan.202000083>
- Cuartero, M., Ortuño, J. A., Truchado, P., García, M. S., Tomás-Barberán, F. A., & Albero, M. I. (2011). Voltammetric behaviour and square-wave voltammetric determination of the potent antioxidant and anticarcinogenic agent ellagic acid in foodstuffs. *Food Chemistry*, 128(2), 549–554. <https://doi.org/10.1016/j.foodchem.2011.03.064>
- Gheibi, S., Karimi-Maleh, H., Khalilzadeh, M. A., & Bagheri, H. (2013). A new voltammetric sensor for electrocatalytic determination of vitamin C in fruit juices and fresh vegetable juice using modified multi-wall carbon nanotubes paste electrode. *Journal of Food Science and Technology*, 52(1), 276–284. <https://doi.org/10.1007/s13197-013-1026-7>
- Gopalakrishnan, A., Sha, R., Vishnu, N., Kumar, R., & Badhulika, S. (2018). Disposable, efficient and highly selective electrochemical sensor based on Cadmium oxide nanoparticles decorated screen-printed carbon electrode for ascorbic acid determination in fruit juices. *Nano-Structures & Nano-Objects*, 16, 96–103. <https://doi.org/10.1016/j.nanoso.2018.05.004>
- Gulaboski, R., & Pereira, C. M. (2008). Electroanalytical Techniques and Instrumentation in Food Analysis. In S. Oltes (Eds.). *Handbook of Food Analysis Instruments* (pp. 379–402). Amsterdam University Press.
- Ijleri, V. S., Jaiswal, P. V., & Srivastava, A. K. (2001). Chemically modified electrodes based on macrocyclic compounds for determination of Vitamin C by electrocatalytic oxidation. *Analytica Chimica Acta*, 439(2), 291–297. [https://doi.org/10.1016/S0003-2670\(01\)00989-8](https://doi.org/10.1016/S0003-2670(01)00989-8)
- Intarakamhang, S., Leson, C., Schuhmann, W., & Schulte, A. (2011). A novel automated electrochemical ascorbic acid assay in the 24-well microtiter plate format. *Analytica Chimica Acta*, 687(1), 1–6. <https://doi.org/10.1016/j.aca.2010.11.023>
- Leonard, S. S., Cutler, D., Ding, M., Vallyathan, V., Castranova, V., & Shi, X. (2002). Antioxidant properties of fruit and vegetable juices: more to the story than ascorbic acid. *Annals of clinical and laboratory science*, 32(2), 193–200.
- Makhotkina, O., & Kilmartin, P. A. (2012). The phenolic composition of Sauvignon blanc juice profiled by cyclic voltammetry. *Electrochimica Acta*, 83, 188–195. <https://doi.org/10.1016/j.electacta.2012.07.101>
- Piljac-Žegarac, J., Valek, L., Martinez, S., & Belščak, A. (2009). Fluctuations in the phenolic content and antioxidant capacity of dark fruit juices in



refrigerated storage. *Food Chemistry*, 113(2), 394–400.

<https://doi.org/10.1016/j.foodchem.2008.07.048>

Pisoschi, A. M. (2015). Voltammetry as Analytical Technique in the Study and Quantitation of Several Food and Beverage Components: An Editorial. *Biochemistry & Analytical Biochemistry*, 04(02).
<https://doi.org/10.4172/2161-1009.1000e156>

Pisoschi, A. M., Danet, A. F., & Kalinowski, S. (2008). Ascorbic Acid Determination in Commercial Fruit Juice Samples by Cyclic Voltammetry. *Journal of Automated Methods and Management in Chemistry*, 1–8.
<https://doi.org/10.1155/2008/937651>

Pisoschi, A. M., Pop, A., Negulescu, G. P., & Pisoschi, A. (2011). Determination of Ascorbic Acid Content of Some Fruit Juices and Wine by Voltammetry Performed at Pt and Carbon Paste Electrodes. *Molecules*, 16(2), 1349–1365.
<https://doi.org/10.3390/molecules16021349>

Tadese, A., Subramanian, P. A., Woldu, A., & Pal, R. (2014). Electrochemical determination and comparison of ascorbic acid in freshly prepared and bottled fruit juices: A cyclic voltammetric study. *Journal of Chemical and Pharmaceutical Research*, 6(5), 880-888.

Vu, D. L., Žabčiková, S., Červenka, L., Ertek, B., & Dilgin, Y. (2015). Sensitive Voltammetric Determination of Natural Flavonoid Quercetin on a Disposable Graphite Lead. *Food Technology and Biotechnology*, 53(4), 379-384.
<https://doi.org/10.17113/ftb.53.04.15.4176>

Yilmaz, S., Yagmur, S., & Sadıkoğlu, M. (2008). Determination of Ascorbic Acid in Table Dosage Forms and Some Fruit Juices by DPV. *International Journal of Electrochemical Science*, 3, 1534-1542.

Yola, M. L., Göde, C., & Atar, N. (2017). Determination of rutin by CoFe₂O₄ nanoparticles ionic liquid nanocomposite as a voltammetric sensor. *Journal of Molecular Liquids*, 246, 350–353. <https://doi.org/10.1016/j.molliq.2017.09.072>



Spatial Mapping and Modeling of Reported Dengue Incidences in Luzon

Nicole M. Hernandez, Carla Katrine P. Lucero, Dianne C. Yumol
and Jericho Manuel A. Zulueta
De La Salle University Integrated School, Manila

Shirlee R. Ocampo
De La Salle University, Manila

Abstract: Dengue, the most rapidly spreading mosquito-borne viral infection, has significantly spread worldwide in recent decades - flourishing both in affluent and impoverished locations of tropical and subtropical countries. In 2012, the Philippines ranked fourth out of the ten Association of the Southeast Asian Nations (ASEAN) countries in having the highest number of dengue cases. The following study intends to analyze the spatial distribution of dengue incidences across all Luzon provinces in 2018. It aims to determine significant correlates that affect dengue incidences, map the incidence rate of dengue cases, and explore the clustering of recorded dengue cases. Poisson and Negative Binomial (NB) regression analyses and Multiple Linear Regression Models (MLRM) were applied to determine the significant correlations affecting dengue incidence rates. Simultaneously, spatial mapping was utilized to visualize and detect clustering in the provinces through dengue count, incidence ratios, and standard incidence ratios (SIR). MLRM and NB showed that rainfall and poverty incidence are significant correlates of dengue counts and incidence, and Nueva Ecija and Tarlac were observed to be provinces with distinct dengue count and SIR greater than 1, as well as provinces found in clusters. With the provided results, health organizations can provide health programs and allocate more funds in areas with SIR greater than 1 to prevent dengue spreading.

Key Words: spatial mapping; regression modeling; dengue incidence; correlation; *Aedes aegypti*

1. INTRODUCTION

Dengue is the most quickly spreading mosquito-borne virus in the world. According to WHO (2020a), dengue's global incidence rate has increased in recent decades, wherein about half of the world's population is now at risk, with 100-400 million infections occurring each year. In 2016, more than half of the 375,000 reported cases in the Western Pacific region were solely from the Philippines.

In the first half of 2019, the Philippines experienced a dengue outbreak which accounted for 146,062 dengue cases and 600 casualties. By the end of 2019, the total cases went up to 429,409 - which is higher compared to 241,707 cases revealed during 2018 (WHO, 2020b). Studies on dengue incidence usually delve into environmental factors in a particular region. However, factors such as dengue count per province have not been recorded in previous papers, making it crucial to address other contributing factors affecting dengue incidence.

Therefore, the following study aims to identify the significant correlates that affect dengue incidences across Luzon's provinces in 2018, map the

percentages of dengue incidence rates in Luzon, and explore the clustering of recorded dengue cases to identify high-risk areas on a broad geographical scale. The study will focus on the spatial mapping and regression modeling of dengue across all provinces of Luzon.

2. METHODOLOGY

The complete available DENC data set from the provinces of Luzon in 2018 was requested and utilized from the Department of Health (DOH) Regional Offices by coordinating with their epidemiology units. Data for the variables relative humidity (RH), rainfall (RF), and temperature (TMIN, TMAX, and TMEAN) were obtained from PAG-ASA Synoptic Stations; and population (POP) and poverty incidence (POVINC) were retrieved from DOH and the Philippine Statistics Authority; all of which were summarized upon collection. Microsoft Excel, Statistica, SAS, and GeoDa were utilized to perform Standardized Incidence Ratio (SIR), MLRM, Poisson and NB regression models, and Spatial Mapping respectively.



2.1. Theoretical Framework and Analysis

2.1.1. Standardized Incidence Ratio (SIR)

SIR determines if the occurrence of a disease in a relatively small population is high or low. It predicts if the number of observed cases in a particular geographic area, $i = 1, 2, \dots, m$, is higher or lower than expected (Natividad et al., 2019).

The common risk, r , or incidence rate of a region is computed by

$$r = \frac{y}{N}$$

where,

y = total count of the disease, and

N = total population exposed to risk in the region

SIR is obtained by:

$$SIR_i = \frac{y_i}{e_i}$$

where,

y_i = observed number of cases

e_i = expected number of cases

The expected number of cases, e_i , can be calculated using indirect standardization

$$e_i = rN_i$$

where,

N_i = the population in the region

r = common risk

2.1.2. Multiple Linear Regression Model

MLRM distinguishes the relationship between two or more independent variables and a dependent variable. It determines if changes in the independent variables can alter the dependent variable and approximate the variables' association. The dependent variable Y_i is considered to be a function of $p-1$ independent variables, $X_{1i}, X_{2i}, \dots, X_{(p-1)i}$, and their association can be written as:

$$Y_i = \beta_0 + \beta_1 X_{1i} + \beta_2 X_{2i} + \dots + \beta_{p-1} X_{(p-1)i} + \epsilon_i \quad i = 1, 2, \dots, n$$

where,

Y_i = the value of the dependent variable of observation i ,

$X_{1i}, X_{2i}, \dots, X_{(p-1)i}$ = the values of $p-1$ predictors or independent variables, and

ϵ_i = corresponds to the random error.

2.1.3. Poisson Regression Model

The Poisson regression model is used when Y_i is a count variable. It assumes that the response variable is following Poisson distribution with parameter λ , $Y_i \sim \text{Poisson}(\lambda)$.

$$E[Y] = \beta_0 + \beta_1 X_1 + \dots + \beta_{p-1} X_{p-1} = e^{X'\beta}$$

where,

Y is the dependent variable,

β is the $p \times 1$ vector of regression parameters

X is a $p \times 1$ vector of independent variables.

2.1.4 Negative Binomial Regression Model

The NB model has the same mean structure as Poisson regression and is considered a generalized Poisson regression model. It contains an extra parameter to model overdispersion - narrowing the confidence intervals. NB is expressed as:

$$f(y) = \frac{\Gamma(y+r) \Gamma(r-12-p)}{\Gamma(r) \Gamma(y+1) \Gamma(r-12-p) \Gamma(r-12-p)} r^{12-p} (1-r)^{12-p} r^{12-p} (1-r)^{12-p} y \quad y=0,1,2,\dots$$

where,

$$i = \exp\{X_i\beta\}$$

r = dispersion parameter

$\Gamma(\cdot)$ = usual gamma function

The following distribution has a mean equal to i and a variance equal to $i + r \cdot i$.

3. RESULTS AND DISCUSSION

3.1. Descriptive Statistics and Standardized Incidence Ratio (SIR)

The SIRs of dengue for the provinces of Luzon for 2018 were computed and summarized. In Table 3.1, 18 provinces and one district have an SIR greater than 1, implying that more dengue cases were observed than expected. Batanes had the highest relative risk of infection, followed by Apayao and Quirino. Meanwhile, the remaining 17 provinces and three districts experienced lesser cases of dengue. Clustering can be observed in provinces shaded in the same color, implying that the nearness of the values between dengue cases, incidence rates, and SIR of nearby provinces display a high dengue risk.

Table 3.1. Dengue Count and the Population Exposed to Risk in Each Province with Corresponding Incidence Ratios and Standard Incidence Ratios

Provinces	Annual Dengue Count	Population exposed to risk	IR	SIR
Ilocos Norte	1886	607,454	0.003105	1.0838
Ilocos Sur	2014	707,531	0.002847	0.9936
La Union	2474	812,620	0.003044	1.0627
Pangasinan	8486	3,059,609	0.002774	0.9682
Batanes	1151	17,613	0.065349	13.716
Cagayan	2743	1,242,768	0.002207	0.4632
Isabela	7657	1,654,287	0.004629	0.9714
Nueva Vizcaya	3375	470,408	0.007175	1.5058

Table 3.1. (cont.) Dengue Count and the Population Exposed to Risk in Each Province with Corresponding Incidence Ratios and Standard Incidence Ratios

Quirino	2137	196,119	0.010896	2.2869
Aurora	917	221,966	0.004131	1.5923
Bataan	2409	804,530	0.002994	1.1541
Bulacan	6476	3,515,504	0.001842	0.7100
Nueva Ecija	7062	2,268,553	0.003113	1.1999
Pampanga	6329	2,772,276	0.002283	0.8799
Tarlac	6657	1,420,364	0.004687	1.8065
Zambales	940	864,368	0.001087	0.4192
Batangas	2,757	2,887,957	0.000955	0.5288
Cavite	6,948	4,051,031	0.001715	0.9500
Laguna	5,647	3,258,735	0.001733	0.9598

Table 3.1. (cont.) Dengue Count and the Population Exposed to Risk in Each Province with Corresponding Incidence Ratios and Standard Incidence Ratios

Masbate	286	926,118	0.000309	0.5253
Sorsogon	512	823,469	0.000622	1.0577
Abra	1,095	244,800	0.004473	1.2543
Apayao	1,866	122,978	0.015173	4.2549
Benguet	1,344	832,635	0.001614	0.4526
Ifugao	851	209,611	0.004060	1.1385
Kalinga	1,582	219,077	0.007221	2.0250
Mountain Province	315	154,814	0.002035	0.5706
NCR-D1	29,618	2,899,200	0.010199	0.9060
NCR-D2	13,367	5,274,265	0.002534	1.1536
NCR-D3	5,802	3,015,062	0.001924	0.8759
NCR-D4	4,678	2,292,509	0.002041	0.9288

Table 3.1. (cont.) Dengue Count and the Population Exposed to Risk in Each Province with Corresponding Incidence Ratios and Standard Incidence Ratios

Quezon	3,841	2,202,097	0.001744	0.9661
Rizal	6,850	3,132,745	0.002187	1.2111
Marinduque	168	238,317	0.000705	0.2883
Occidental Mindoro	1,155	507,630	0.002275	0.9304
Oriental Mindoro	1,891	878,330	0.002153	0.8804
Palawan	3,787	1,170,905	0.003234	1.3225
Romblon	573	297,808	0.001924	0.7868
Albay	306	1,362,255	0.000225	0.3821
Camarines Norte	551	606,997	0.000908	1.5442
Camarines Sur	1,829	2,028,696	0.000902	1.5337
Catanduanes	53	269,469	0.000197	0.3346

Figure 3. Standard Incidence Ratios of Dengue Count and Population per Province

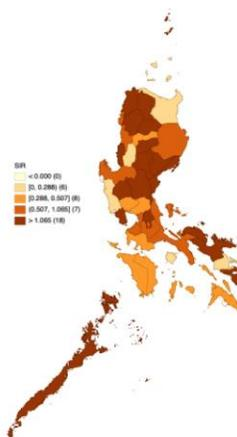

Figure 1. Plot Map for the Accumulated Dengue Count per Province

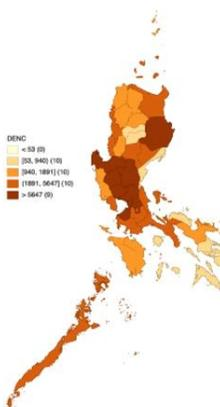

Figure 2. Map of the Incidence Rate of Dengue Count and Population per Province

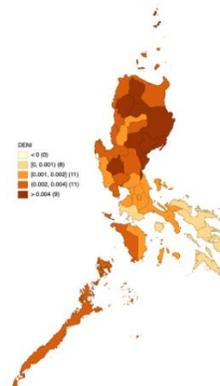

Figure 1 shows the map for the variable DENG, wherein provinces around the center of Luzon are reported to have a high dengue count in 2018.



Clustering is observed, revealing that dengue cases occurring in these areas may be due to spreading. In Figure 2, dengue incidences were derived from dividing DENC by the total population in each province, and it revealed that provinces in the northeastern part of Luzon had high incidence rates. Lastly, Figure 3 shows the SIR of dengue cases and the total population of each province, where provinces located in Region 2 and 3 are observed to have high reported SIRs of dengue. Despite Batanes having the highest SIR, Cagayan did not have a high SIR in 2018. However, provinces that have a clustering of SIR greater than 1 were observed in Central Luzon.

3.2. Multiple Linear Regression Model

MRLM was applied to dengue cases and incidences but did not satisfy all assumptions. Thus, three transformations were utilized - namely $\arcsin(y)$, $\ln(y)$, and $\ln(1-yy)$. Only $\ln(y)$ for DENC satisfied all the assumptions. Stepwise selection procedure was utilized in selecting variables that fit the model. Figure 4 shows that all p-values are greater than 0.05, thus, the residuals are normally distributed.

Figure 4. Normality Test

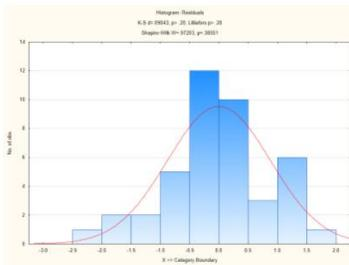

The homogeneity of variances was checked through a scatterplot of residuals versus predicted values. No clear pattern should be in the distribution or the data would be heteroscedastic. From Figure 5, since there is no cone-shaped pattern, the assumption has been satisfied.

Figure 5. Predicted vs Residual Scores

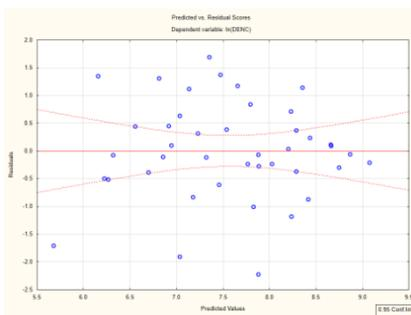

The next assumption checked was the independence within the residuals through the Durbin-Watson test. In Table 4 (see appendix), as the serial correlation is approximately 0, there is no correlation between the observations. Additionally, since the Durbin-Watson statistic falls between 1.5 and 2.5, there is no first order correlation.

Lastly, there should be no multicollinearity, which occurs when the independent variables are highly correlated with each other. Since the tolerance limits on Table 5 (see appendix) are greater than 0.01, there is no multicollinearity. The errors are also normally distributed with mean 0 and constant variance.

The following output was generated following a 5% level of significance with $\alpha = 0.39828405$. Table 3.2.1 shows the simplified summary of results while Table 3 (see appendix) shows the full summary.

Table 3.2.1. Simplified Summary of Results of MLRM for $\ln(\text{dengue count})$

Variables	b*	Std. Err. of b*	b	Std. Err. of b	t(39)	p-value	e ^b
Intercept			15.25959	4.760606	3.20539	0.002826	
RF	-0.35336	0.149695	-0.00381	0.001615	-2.36053	0.023786	0.70232
POVINC	-0.35716	0.143864	-0.08164	0.032885	-2.48261	0.017840	0.69966

The summary of results shows that there are two significant dengue correlates: POVINC ($r = -0.35716$, $p < 0.05$) and RF ($r = -0.35336$, $p < 0.05$). A possible explanation for the negative correlation is when POVINC decreases in a certain area, people would flock there for more job opportunities, resulting in more chances for dengue to spread.

Moreover, studies showed that heavy rainfall can possibly lessen dengue fever transmission by reducing the survival rate of mosquitoes. Thammapalo et al. (2005) analyzed the independent effects of rainfall in Thailand, and they suggested that dengue cases have a slightly negative correlation with the precipitation in some provinces.

3.3. Poisson Regression Model

The GENMOD procedure was utilized to obtain the Poisson regression model because it can fit a wide range of generalized linear models. The $\log(\text{pop})$ function was specified as an offset to account for possible different observation periods. Additionally, the DSCALE function was utilized due to overdispersion. The simplified results are seen in Table 3.3.1. while Table 6 (see appendix) shows the full analysis. Table 3.3.1. shows that the POP variable has a $p < 0.05$ ($p = 0.0184$), which indicates that POP is a significant correlate of DENC as expected because



the bigger the population, the greater the chance of getting infected.

Table 3.3.1. Simplified Analysis of Maximum Likelihood Parameter Estimates of Poisson Regression with DSCALE Function

Parameter	DF	Estimate	Standard Error	Wald 95% Confidence Limits		Wald Chi-Square	Pr > ChiSq
Intercept	1	3.1095	2.7332	-2.2474	8.4664	1.29	0.2553
POP	1	0.0000	0.0000	0.0000	0.0000	5.56	0.0184

3.4. Negative Binomial Regression

Due to the overdispersion in Poisson regression, NB was used. The full results are in Table 7 (see appendix). On Table 3.4.1., the independent variables RF (p=.0028) and POVINC (p=.0007) show a p<0.05, meaning that RF and POVINC are statistically significant predictors of DENC.

Table 3.4.1. Simplified Analysis of Maximum Likelihood Parameter Estimates of Negative Binomial

Parameter	DF	Estimate	Standard Error	Wald 95% Confidence Limits		Wald Chi-Square	Pr > ChiSq
Intercept	1	3.5627	3.1367	-2.5851	9.7104	1.29	0.2560
RF	1	-0.0033	0.0011	-0.0054	-0.0011	8.94	0.0028
POVINC	1	-0.0650	0.0192	-0.1027	-0.0273	11.43	0.0007

Based on Table 5 (see Appendix), the NB model is,

$$\log\{E[Y]\} = 3.5627 - 0.0033 \text{ RF} + 4.3856 \text{ TMAX} + 4.0906 \text{ TMIN} - 8.5210 \text{ TMEAN} - 0.0038 \text{ RH} - 0.0650 \text{ POVINC}$$

while the model with the significant correlates is,

$$\log\{E[Y]\} = 3.5627 - 0.0033 \text{ RF} - 0.0650 \text{ POVINC}$$

where E[Y] is the expected DENC per province.

Results showed that the provinces with the highest expected DENC are Tarlac (E[Y] = 2.055) and Nueva Ecija (E[Y] = 2.249), which are in areas with clustering of SIR greater than 1. RF and POVINC may be attributed as factors for high clustering in Central Luzon as the two provinces have previously recorded about 7,000 raw dengue cases with a poverty incidence of 7.73 and 6.57, respectively. Although some provinces have high DENC, POVINC must also be considered since it is an important factor in the NB model. Thus, Tarlac and Nueva Ecija are the only provinces with notable expected DENC due to high DENC and POVINC values.

The results of this study are consistent with a 2008 study by Sia-Su about the relationship of climatic factors and dengue prevalence in Metro Manila. Through MLRM, the results show that there is a significant correlation between rainfall and dengue incidence (r = 0.614, p < 0.05). It proved that dengue incidence in the region varies as rainfall patterns change. Moreover, this study explored the statistical procedures Poisson and NB regressions which led to an additional significant correlate, POVINC, of dengue counts and incidences in the Luzon provinces.

4. CONCLUSIONS

The Philippines remains one of the countries reporting high dengue cases globally. In practice, dengue surveillance relies mainly on disease reporting units. However, the illness limits reporting accuracy, leading to a multitude of unrecorded and under-reported dengue episodes. In this paper, significant dengue correlates were obtained and adapted into a MLR and Poisson Regression model. However, due to overdispersion in Poisson Regression, NB was used instead. Both MLRM and NB results revealed that POVINC and RF significantly correlate to DENINC. Although both showed similar significant correlates, the NB model has higher adjusted predictors.

DENC, IRs, and SIRs were mapped in Luzon provinces. The heat maps display hotspots in a specific area which are vital for observing clusters. Results show that Nueva Ecija and Tarlac have SIR higher than 1 and are found in high-risk cluster areas. These are accredited to RF and POVINC, as the NB model has revealed that the following provinces have the highest expected DENC.

With that, it is essential to monitor these provinces as they can be possible sources of dengue spreading in 2018. Although the data is from 2018, the derived results can approximate future dengue trends. Health organizations can use these results to provide health programs and allocate more funds in areas with SIR higher than 1. Visayas and Mindanao provinces should also be tested and modeled to ensure the Filipinos' safety from dengue and include them in programs.

It is also recommended to create a better estimate of the dengue counts by adding more independent variables other than meteorological factors. Additionally, the utilization of heat maps for data visualization, which focuses on new fields like data science, can help determine factors contributing to the spread of dengue.

Considering the COVID-19 pandemic, the statistical procedures used can be executed in determining factors correlating to the increase in COVID-19 cases. Given the availability of data, researchers can secure copies for statistical



procedures; and adding variables such as population density, number of hospitals, and Intensive Care Units (ICUs) can be utilized to predict COVID-19 incidences and create a better-fitting model for predictions.

5. ACKNOWLEDGMENTS

First and foremost, the researchers would like to praise and thank God, the Almighty, who has granted countless blessings, knowledge, and opportunities to the researchers. They would like to thank Him for his guidance during the construction of the research paper.

Furthermore, they would also like to acknowledge the assistance of the epidemiology units that provided data for statistical analyses despite the ongoing COVID-19 pandemic. In addition, they would also like to thank them for their patience and understanding with the flurry of emails delivered by the researchers - enabling them to secure data for their research.

The researchers are indebted to the guidance and patience of their research adviser, Ms. Shirlee Ocampo from the Mathematics and Statistics Department of De La Salle University, in the formulation of this research paper and in answering all of the researchers' questions and never getting tired from it. Without her encouragement and advice, the researchers would not have been able to improve on the flaws of the research paper. They would also like to thank Mr. Angelo Alberto for his counsel and Practical Research lectures. During the duration that he was with the researchers, he brought out the best in them through his constructive criticism and enlightening insights.

Last but not the least, the researchers would like to acknowledge each other's efforts during the research process. Their providence of support and appreciation for each other led to the finishing of their research paper.

6. REFERENCES

Natividad, J.M., Necesito, R.M., Ocampo, S., & Leong, R.N. (2019). Bayesian conditional autoregressive model for mapping human immunodeficiency virus incidence in the national capital region of the Philippines. 62nd ISI World Statistics Congress, pp. 291-299.

Sia Su, G. L. (2008). Correlation of climatic factors and dengue incidence in Metro Manila, Philippines. *AMBIO: A Journal of the Human Environment*, 37(4), 292-294. doi:10.1579/0044-7447(2008)37[292:cocfad]2.0.co;2

Thammapalo, S. , Chongsuwiatwong, V., McNeil, D., & Geater, A. (2005). The climatic factors

influencing the occurrence of dengue hemorrhagic fever in Thailand. *Southeast Asian Journal of Tropical Medicine and Public Health*; 36(1):191-6. PMID: 15906666.

World Health Organization. (2020a, March 2). Dengue and severe dengue. World Health Organization. <https://www.who.int/en/news-room/fact-sheets/detail/dengue-and-severe-dengue>

World Health Organization. (2020b, January 16). Update on the Dengue situation in the Western Pacific region. World Health Organization. https://www.who.int/docs/default-source/wpro---documents/emergency/surveillance/dengue/dengue-20200116.pdf?sfvrsn=fc80101d_28



The Integration and Appraisal of Electronic Medical Records (EMR) in Cotabato Regional and Medical Center

Jeffrey Harold C. Chan, Aerelle Myeica S. Manansala
and Redj Nicole L. Mojares

De La Salle University Integrated School, Manila

Abstract: This research investigates the adoption, implementation, and overall satisfaction of electronic medical records (EMR) in the Cotabato Regional and Medical Center (CRMC). A purposive sampling method was utilized in the recruitment of the participants after getting clearance from its ethical review board. This study engaged 16 participants from CRMC: administrators, health personnel, and non-health personnel. The participants responded in a google survey form with structured and unstructured items that centered on the what, when, how, and why of the adoption of the implementation of the EMR and their overall satisfaction. EMR adoption in CRMC is associated with the mandate from the Department of Health's initiative to modernize the health care system in the Philippines. The hospital's top administration initiated the adoption with consultations from the different stakeholders in the hospital. Several consultations were conducted, and training of both healthcare and non-healthcare personnel were conducted to prepare the hospital system. Despite these efforts, several issues confronted the efficient implementation of EMR in the recording, archiving, and retrieval of the medical records which include: internet connectivity, lack of skilled manpower to handle the EMR system, financing issues, and preference of other personnel to the "manual process" of doing things. Interestingly, the level of overall satisfaction on the implementation of EMR remains to be high. Improved infrastructure, more training, and recruitment of skilled staff are recommended to optimize the utilization of EMR.

Key Words: electronic medical records; ehealth; structure-process-output assessment, Cotabato Regional and Medical Center; Philippine healthcare system

1. INTRODUCTION

1.1. Background of the Study

The medical and healthcare aspect in the Philippines continuously inclines itself to modernization and advancements. The adaptation of eHealth in the Philippines started in the year 1998 (DOH & DOST, 2014). The eHealth system in the Philippines aims to draw a long-term strategic plan for developing a lasting healthcare system, develop the infrastructure of ICTs for more equitable and affordable access, reach communities and vulnerable groups far from the urban life, and mobilize multi-sectoral collaboration with the different departments. This technology is designed for the collection, retrieval, and sharing of medical knowledge by health providers (Angst & Agarwal, 2009).

The Cotabato Regional and Medical Center (CRMC), located in Cotabato City, Bangsamoro is a tertiary government hospital under the Department of Health (CRMC, n.d.). The hospital is regulated by the Civil Service Commission, the Department of Budget and Management, and Commission of Audit. CRMC

started with a 12-bed capacity in 1916. Due to demand and modernization, the hospital can now accommodate a 400-bed capacity. The group has decided to conduct a study in this particular area not only because it is accessible but rather it could also give a different perspective of the usage of EMR, especially in provincial areas. Before utilizing the electronic medical record, the institution has been using the manual process of pen and paper to record, retrieve, and archive data. It was only recently when CRMC made use of the system following the launch of the Integrated Hospital Operations Management Information System (IHOMIS) and The Integrated Hospital Operations and Management Program (IHOMP). The adoption of EMRs has been plagued with issues and pushback with its implementation as the enforcement of a new system would burden the hospitals with financial and educational incentives along with doubts if it would be a more efficient addition to the Philippine hospital system.



1.2. Statement of the Problem

This study investigates the effectiveness of the utilization of EMRs to provide quality health care services in Cotabato Regional and Medical Center (CRMC), a public hospital in Cotabato City, Maguindanao. The following specific questions are sought:

1. What are the preparations and other resources on the implementation of EMR in the provision of health services in CRMC?
2. What is the attitude of the medical staff on the integration of EMR in the provision of health services?
3. What are the perceived benefits of the medical staff on the integration of EMR in the provision of health services?
4. What are the issues and challenges that confronted the medical staff on the integration of EMR in the provision of health services?
5. How are the issues and challenges addressed by the medical staff on the integration of EMR in the provision of health services?
6. What lessons can be generated on the integration of EMR in the provision of quality of health care service in CRMC?

1.3. Conceptual Framework

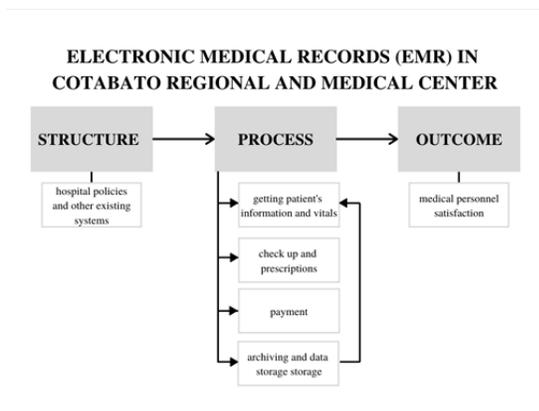

[Figure 1.1 Conceptual Framework of EMR implementation in Cotabato Regional and Medical Center, 2020 Source: Adopted from the Conceptual framework of Berhe et al. and modeled from the Deleon and Maclean Model (D&M)]

Micheale Berhe, et al.'s (2017) structure-process-outcome assessment model is adopted to investigate the efficiency of the implementation of EMR in CMRC. Structure refers to the observance of the eHealth Law, hospital policies, institutional training in EMR, and placement of infrastructure

systems. Process refers to the systematic flow of the utilization of Electronic Medical Records in collecting, recording, archiving, and retrieval of patient's records and vital information, check-ups, prescriptions, and the payment and accounting system. Lastly, the Outcomes refer to the perceived satisfaction of the medical personnel towards the usage of Electronic Medical Records in CRMC.

1.4. Scope and Limitations

This study centers on the assessment of the efficiency in the implementation of EMR in CRMC in three major domains: structure, process & outcomes. Engaging the different levels of administration, and both health care and non-healthcare personnel is intended to collect their different perceptions, observance, utilization, and satisfaction. This is based on the understanding that each stakeholder has a different experience with EMR thus influencing their appraisal and satisfaction with the system. COVID 19 pandemic and strict implementation of community quarantine limit the opportunity for the researchers to conduct in-person interviews. Poor internet connection and the difficulty in the recruitment of participants had also prevented the researchers from adopting online interviews via Google Meet or Zoom.

1.5. Significance of the Study

With the existing technologies present in the Philippines, it is still evident that the implementation of Electronic Medical Records (EMR) in institutions needs improvements and refinements. Despite this, EMRs remain a crucial bridgeway to an advanced healthcare system in the entire country. It is generally recognized that the EMR has the ability to be the central electronic health-care information and communication device (Ball 2003; Haux 2006; Chang & Chang 2008). The Electronic Medical Record (EMR) is an innovative technology that enables doctors' practices to implement more effective performance assurance initiatives than paper-based documents can do, although achieving quality enhancement by the use of EMR is neither low-cost nor simple (Miller and Sim 2004). Increased use of electronic medical records (EMRs) is generally believed to improve the quality of health care and the reliability with which it is provided.

2. METHODOLOGY

2.1. Research Design

This study investigated the effectiveness of the utilization of EMRs to provide quality health care services in CRMC utilizing an institutional case study design. An institutional case study research design



was adopted due to its compatibility with the structure-process-output assessment model.

2.2. Sampling

Purposive sampling method was adopted in the recruitment of the participants of the study. The study recruited 16 medical and non-medical personnel: (3) administrator/s, (5) medical staff (doctors), (2) nurse/s, (2) midwives, (1) radiologic technologist/x-ray technician, (1) medical technologist, support staff ((2) IT staff) who use EMR at work. The primary criterion in the recruitment include: (1) Individuals with medical or technical experience in Cotabato Regional and Medical Center, and (2) Personnel from Cotabato Regional and Medical Center (CRMC).

2.3. Instrumentation

A Google Form Survey was the primary instrument adopted in this study which was divided into four major sections: 1) whats, hows, and whys of the adoption of EMR, 2) the actual EMR engagement and experience of the participants, 3) the issues and challenges in the implementation, and 4) their overall satisfaction. Open-ended items were formulated for the first three sections and an overall satisfaction measure with five-point agreement Likert scale was formulated for the fourth section.

2.4. Data Gathering Procedure

The researchers secured the approval of the CRMC administration and the in-house ethical review committee before proceeding to the process of recruitment of the participants. The researcher initially listed 18 participants who met the recruitment criteria, however, only 16 respondents responded to the invitation. Informed consent was secured before providing the participants with the link to the Google Survey Form.

2.5. Data Analysis Strategy

Braun & Clark (2006) six-stage thematic analysis was adopted in the analysis of the responses in the open-ended questions: 1) familiarization, 2) coding, 3) theme-development, 4) review, 5) defining of themes, and 5) report writing the researchers will analyze the data harvested. The measure of central tendency, mean, for each item in the overall satisfaction measure was prepared to present the level of satisfaction of the participants in the different processes where EMR is implemented.

3. RESULTS AND DISCUSSION

Adoption and Implementation of EMR

The implementation of EMR in Cotabato Regional and Medical Center was due to the compliance of the hospital administration with the directive from the DOH Central Office. The Department of Health launched the Integrated Hospital Operations Management Information System (IHOMIS) and The Integrated Hospital Operations and Management Program (IHOMP) which directed all hospitals in the country to comply with the directive. However, most participants noted that their hospital adoption of the EMR system was also in consideration of the Philhealth Incorporated requirements for hospital accreditation.

Several of the challenges faced by the institution regarding the implementation of the system include internet connectivity, financial, and manpower issues. These serve as the common barrier in the utilization of EMR in the recording of patients' information and vitals, check-up, prescriptions, and payment systems in the hospital. Despite this, over time with the continuous implementation of EMR in CRMC and the development and training of the institution the advantages of EMR may be fully utilized by the personnel with adequate time.

Issues and Challenges in the Utilization of EMR

The main challenge in the implementation of EMR is associated with very poor or intermittent internet connection. System lag and poor connection due to weak LAN are two of the main issues identified by the medical personnel. Lack of manpower and equipment also affects the overall process of recording, archiving, and retrieval of patient's records and vital information, medical check-ups, prescription, and payment. The whole process is observed to be time-consuming and requires double the work, as not everyone is technologically literate. As such, most of the staff prefer manual processes instead of utilizing EMR. Some participants also raised the issue of incorrect and double entry as to the reason for preferring the manual process instead of EMR. Internet connectivity, just like in other areas of EMR implementation, has been considered a major challenge in the integration of EMR in the accounting or payment system. Adding to this issue is the lack of skilled staff to attend to this process. Additional burdens include payment adjustments and the availability of the funds from PhilHealth to cover a patient's medical bill. The additional cost of the adoption of accounting software is also considered a major issue. The encoding of the records has also been delayed or is not always updated.



Overall Satisfaction on the Implementation of EMR

There is a high level of satisfaction among the participants on the implementation of EMR in CRMC in all areas where it is adopted (see Table 1). There is a high level of satisfaction on the utilization of EMR in the recording (m=4.07, sd=0.70), archiving (m=4.27, sd=0.70) and retrieving (m=4.53 sd=0.52) of patient's information and vital records. High levels of satisfaction was also found among the participants on the utilization of EMR in the recording (m=3.93, sd=0.79), archiving(m=4.13, sd=0.49), and retrieving (m=4.33 sd=0.78) of patient checkups. Additionally, there is a high level of satisfaction was found among the participants on the utilization of EMR in the recording (m=3.87, sd=1.21), archiving (m=3.60, sd=1.23) and retrieving (m=3.60, sd=1.23) of patient's prescriptions. Lastly, there is a high level of satisfaction on the utilization of EMR in the recording (m=4.27, sd=0.72), archiving (m=4.27, sd=0.72) and retrieving (m=4.20, sd=0.79) of patient's information and payments.

Table 1

Overall Satisfaction on the Implementation of EMR

Satisfaction	Mean	SD	Interpretation
Overall Vital			
Recording	4.07	0.70	High
Archiving	4.27	0.70	High
Retrieving	4.53	0.52	High
Overall Checkup			
Recording	3.93	0.79	High
Archiving	4.13	0.49	High
Retrieving	4.33	0.78	High
Overall Prescription			
Recording	3.87	1.21	High
Archiving	3.60	1.23	High
Retrieving	3.60	1.23	High
Overall Payment			
Recording	4.27	0.72	High
Archiving	4.27	0.72	High
Retrieving	4.20	0.79	High

4. CONCLUSIONS

EMR adoption in Cotabato Regional and Medical Center has been associated with the mandate from the Department of Health's initiative to modernize the health care system in the Philippines. The hospital's top administration initiated the adoption with consultations from the different stakeholders in the hospital. Several consultations were conducted and training of both healthcare and non-healthcare personnel was conducted to prepare the hospital system. Despite these efforts, several issues confronted the efficient implementation of EMR

in the recording, archiving, and retrieval of the medical records which include internet connectivity, lack of skilled manpower to handle the EMR system, financing issues, and preference of other personnel to the "manual process" of doing things. Interestingly, the level of overall satisfaction on the implementation of EMR remains to be high. Improved infrastructure, more training, and recruitment of skilled staff are recommended to optimize the utilization of EMR.

5. ACKNOWLEDGMENTS

We would like to express our deep sense of gratitude to Dr. Crisanto Q. Regadio Jr. of the Behavioral Sciences Department for his invaluable mentorship. He has diligently advised and has greatly helped in improving the aspects of this paper. We would also like to acknowledge and thank Dr. Madelene Sta. Maria, Dr. Thelma Mingoa, and Mr. Christian Gopez for guiding the researchers throughout their whole journey. Lastly, the group would like to thank everyone who participated and contributed to make this research possible. We recognize your presence and thank you for your time. You are loved, always remember that. May the force be with you.

6. REFERENCES

Angst, & Agarwal. (2009). Adoption of Electronic Health Records in the Presence of Privacy Concerns: The Elaboration Likelihood Model and Individual Persuasion. *MIS Quarterly*, 33(2), 339. https://www3.nd.edu/~cangst/CoreyAngst_Faculty_Website_files/Angst2009MISQ.pdf

Berhe, M., Tadesse, K., Berhe, G., & Gebretsadik, T. (2017b). Evaluation of Electronic Medical Record Implementation from User's Perspectives in Ayder Referral Hospital Ethiopia. *Journal of Health & Medical Informatics*, 08(01), 4. <https://www.researchgate.net/profile/Gebremedhin-Berhe-Gebregergs/publication/315824479>

Braun, V., & Clarke, V. (2006). Using thematic analysis in psychology. *Qualitative Research in Psychology*, 3(2), 77–101. https://www.researchgate.net/publication/235356393_Using_thematic_analysis_in_psychology

About Us - Cotabato Regional and Medical Center. (n.d). Cotabato Regional and Medical Center. <http://crmc.doh.gov.ph/transparency-seal/about-us>

Department of Health. (2014). Chapter 1 : *Philippine eHealth strategic plan*. http://www.ehealth.doh.gov.ph/index.php?option=com_content&view=category&layout=blog&id=73

Heale, R., & Twycross, A. (2017). What is a case study? *Evidence Based Nursing*, 21(1), 7–8. <https://ebn.bmj.com/content/21/1/7>



A Systematic Review on the Efficacy of Common Antacid Components

Ma. Fatima Jesuniña M. Gornez,
Hailey Vanessa G. Mendoza, Timothy P. Rapacon and Errol Joriz N. Solano
De La Salle University Integrated School, Biñan City, Laguna

Abstract: Gastroesophageal Reflux Disease (GERD) is a common health issue worldwide that utilizes antacids to mitigate its symptoms such as chest pains and burning sensations. However, the most common component used in antacids, Aluminum Hydroxide, has a high toxicity level as it builds up in the body. Thus, this study aims to determine whether Alginate, an organic compound, and Calcium Carbonate, which is considered an age-friendly component, are suitable antacid component alternatives to Aluminum Hydroxide in terms of their corresponding Acid Neutralization Capacity (ANC) and adverse effects. The researchers utilized a systematic review approach, guided by the Preferred Reporting Items for Systematic Review and Meta-Analysis Protocols (PRISMA-P), to accomplish the study objectives. The study results suggest that Calcium Carbonate has the highest ANC while Alginate has the second-highest ANC and has fewer adverse effects than placebo. These results support the claim that Alginate and Calcium Carbonate are suitable alternatives to Aluminum Hydroxide.

Key Words: antacid; gastroesophageal reflux disease; calcium carbonate; alginate; systematic review

1. INTRODUCTION

Gastroesophageal Reflux Disease (GERD) occurs when there are backflows of stomach acid in the esophagus, irritating its walls (Yamamichi et al., 2012). People with GERD have been more prevalent in the Philippines over the years (Sollano et al., 2007). One problem with treating GERD is that the majority of medications contain Aluminum; allergic reactions, such as exposure to xenobiotics, may occur when it is ingested or vaccinated (Crisponi et al., 2013). Though branded safe for usage as Aluminum Hydroxide, Aluminum has a record of toxicity (Jensen-Jarolim, 2015).

Due to this, researchers sought out an organic compound called Alginate derived from algae and Calcium Carbonate, which are also used to formulate antacids (Szekalska et al., 2016). Alginate is in recent antacid formulations because it is organically derived. Additionally, it also develops rafts that help maintain stomach acidity (Hampson et al., 2010). Calcium Carbonate is widely used in antacid formulations because it is suitable for all ages (Li et al., 2018). In comparison to the level of toxicity obtained by consuming Calcium Carbonate, the toxicity of Aluminum Hydroxide is significantly higher (Salisbury & Terrell, 2020). Adverse side effects of Calcium Carbonate are dizziness, nausea, and constipation.

Antacids are formulated to mitigate GERD symptoms, but a problem with this is that one of the most common antacid components is Aluminum Hydroxide, which can be toxic to humans when it

builds up in the body (Crisponi et al., 2013). Thus, this research aims to determine, via a systematic review, if Alginate and Calcium Carbonate are effective alternative antacid components to Aluminum Hydroxide so that this toxic component may eventually be removed in antacids for GERD patients.

The paper is a systematic literature review on the efficacy of common antacid components present in the formulation of over-the-counter medications. The identified components are Alginate and Calcium Carbonate. The collected journals only focused on the properties of these compounds. Different parameters, acid neutralization, and adverse effects were identified and used to evaluate the two chemical components' efficacy. Also, the findings were based on the gathered data; no theoretical computations and primary data were presented. This study will help fill the research gaps in the academic and medical community and will help to further improve antacid formulations.

2. METHODOLOGY

2.1. Study Design

The methodology is composed of three phases as seen in Figure 1. First is the selection process of literature according to predetermined eligibility criteria. Second is the data collection process and the risk of bias assessment of the eligible papers. Last is the generalization of the collected data to determine a suitable alternative to Aluminum Hydroxide based on

Acid Neutralization Capacity or adverse effects. The study's methods were guided by the protocols for reporting systematic reviews adapted from the Preferred Reporting Items of Systematic Reviews and Meta-Analysis (PRISMA) website. Subsections: Eligibility Criteria, Information Sources, Search Strategy, Study Records, ROB assessment, and Data Synthesis, were kept and modified accordingly in this study (Shamseer et al., 2015).

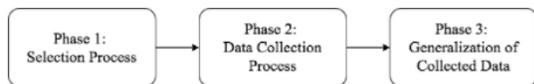

Figure 1. Flowchart of the Main Methodology

2.2. Eligibility Criteria

A literature search was performed where every title of a paper that the researchers read was considered a viewed paper and the papers that met the requirements of the eligibility criteria were considered accepted papers. The eligibility criteria include:

- acceptability - if the paper was published by a reputable publisher and the paper's academic affiliations
- study design - if the paper was quantitative study design
- compound assessed - if the papers studied Alginate or Calcium Carbonate
- parameter for evaluation - if the papers studied Acid Neutralization Capacity or adverse effects

2.3. Information Sources

The researchers prioritized sources such as Google Scholar, JSTOR, Science Direct, and ResearchGate. The researchers used these databases during the initial search period, including the use of the eligibility criteria. Afterward, the researchers branched out to different databases such as school repositories.

2.4. Search Strategy

In searching for literature through different recognized databases, a search strategy using specific keywords and search techniques was applied to set a guided framework for the researchers.

2.5. Study Record

To manage the literature and information, the researchers utilized the software Mendeley,

OneDrive Microsoft Excel, and Risk of Bias Visualizer (ROBVis). The selection process in Figure 2 involved the literature search protocol for systematic reviews, which began with utilizing the search strategy. The criteria for filtering the literature according to its relevance to the study involved reading: title, publisher, and abstract during the search. In the title, the researchers sought out Alginate and Calcium Carbonate, then accepted papers with recognized publishers before scanning the abstract for quantitative study designs mentioning Acid Neutralization Capacity and adverse effects. Journals that did not meet the criteria were not eligible for the study. The researchers viewed a total number of 750 journals.

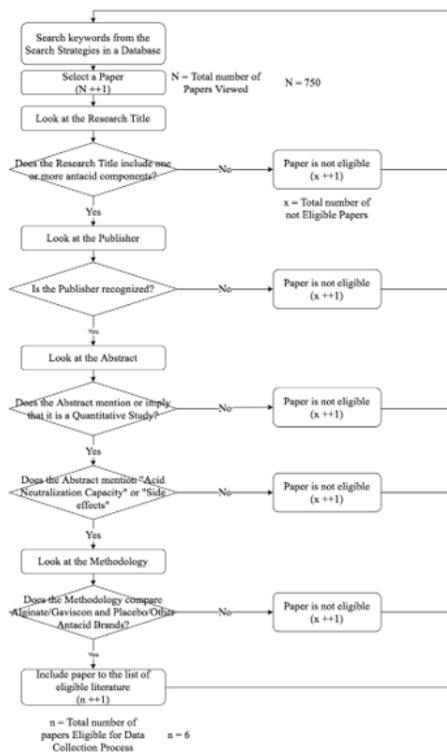

Figure 2. Flowchart of the Selection Process

2.6. Risk of Bias in Individual Studies

In the Cochrane Review Handbook, Higgins & Green (2011) defined bias as a systematic error that must be assessed by considering the Risk of Bias (ROB). This study's objectives require data collection from experimental trials that do not necessarily involve participants. Thus, the researchers modified the criteria from the Cochrane Handbook to suit the study's needs better.



After performing an individual ROB assessment, a general assessment was done by assigning number values for each risk (High = 2; Low = 1; None = 0) and computing for the average of each bias of the paper. The ROB Visualizer for systematic reviews was used to make a visual summary. The general assessment was utilized to justify the conclusions of the study.

Table 1. Risk of Bias Criteria

Bias	Risk	Criteria
Generated Source Type	Low	Primary source
	High	Secondary source Tertiary source
	Unclear	Not Enough Data (NED)
Randomized Testing of Market Antacids	Low	Random selection of market antacids
	High	Specific or non-random selection of market antacids
	Unclear	NED
Number of Trials	Low	5 or more trials
	High	4 or less trials
	Unclear	NED
Declaring the Control Variables	Low	All factors aside from the independent variable are controlled
	High	One or more factors aside from the independent variable are not controlled
	Unclear	NED
Generalizable Outcome Data	Low	Used statistics to determine the significance of results
	High	Did not use statistics to determine the significance of results
	Unclear	NED

Selective Reporting	Low	Specified expected outcomes, reported all of the results
	High	Specified outcomes, selective reporting of results
	Unclear	NED
Other Biases	Low	None
	High	1 or more
	Unclear	NED

2.7. Data Synthesis

The researchers collected information under Acid Neutralization Capacity (ANC) and adverse effects, then categorized the data in Microsoft Excel. Results that agreed with the same hypothesis and have similar implications on the efficacy of the compound were under the same category. The categorized data were used to make generalizations on the ANC and adverse effects of the compounds. These generalizations were the basis for determining whether Alginate and Calcium Carbonate are suitable alternatives to Aluminum Hydroxide for treating Gastroesophageal Reflux Disease (GERD).

3. RESULTS AND DISCUSSION

3.1 General Assessment of Risk of Bias

Figure 4 and Figure 5 present the summary of all risk of bias assessment in terms of the criteria. Generated source type, generalizable outcome data, selective reporting, and other biases had a low risk of bias in total, while the number of trials and declaring the controlled variables had a majority summation of low risk of bias. The overall summary of the risk of bias in the accepted papers is a low risk of bias.

Figure 4 is the traffic plot which is prescribed by Cochrane in presenting the ROB assessment. Green represents a low risk of bias, red for a high risk of bias, and yellow for an unclear risk of bias. The traffic plot's purpose is to illustrate which study and criterion of that study had a different risk of bias judgment from the majority. It was observed that the only high risk of bias came from the randomized testing of market antacids in Tytgat and his team's paper. This implies that in general, the accepted papers are considered to have a low risk of bias.



Figure 4. General ROBVis Assessment Traffic plot

Figure 5 presents the summary of all risk of bias assessment in terms of the criteria. Generated source type, generalizable outcome data, selective reporting, and other biases had low risk of bias in total, while the number of trials and declaring the controlled variables had a majority summation of low risk of bias. Randomized testing of market antacids, although it was observed to have a high risk of bias in one of the papers, resulted in a low risk of bias in the summary. The overall summary of the risk of bias in the accepted papers is a low risk of bias. Meaning, for all accepted papers, no other possible sources of bias were observed.

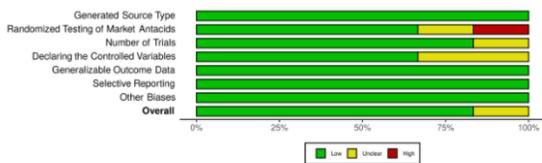

Figure 5. General ROBIS Assessment Summary plot

3.2 Antacid Component with Highest Acid Neutralization Capacity

The Acid Neutralizing Capacity (ANC) was used to test the amount of acid neutralization and the duration of the antacid maintaining the pH level of above 3.5 (Dhawal & Barve, 2020). According to Ayensu et al. (2020), antacid efficacy can be determined according to neutralizing capacity. The information synthesized, as seen in Table 2, implies that Calcium Carbonate, present in the antacid brand Rennie Duo, is a suitable alternative to Aluminum Hydroxide in terms of ANC. This is because Calcium Carbonate shows the highest ANC among the comparators' components, excluding Aluminum Hydroxide. Calcium carbonate, an inorganic salt, neutralizes Hydrochloric acid in gastric secretions when it is dissolved in the stomach, which is why the preferred formulation of Calcium Carbonate is in a compressed powder tablet. Additionally, the collected data supports the claim that Alginate is another suitable alternative to Aluminum Hydroxide since it has the second-highest ANC, below Calcium Carbonate.

Table 2. Resulting Efficacy of Antacids and their components based on ANC

Study	Year Published	Parameters Identified (ANC, adverse effects)	Results (Highest to Lowest Parameter)	Components (of the corresponding antacids)
Hampson, F. C., et al.	2005	ANC	1. Gaviscon Extra Strength (liquid) 2. Mylanta Heartburn Relief (liquid) 3. Algicon (liquid) 4. Rennie Duo (liquid) 5. Gaviscon Regular Strength (liquid)	1. Aluminum Hydroxide 2. Calcium Carbonate 3. Magnesium Alginate 4. Calcium Carbonate 5. Magnesium Carbonate

			6. Gaviscon Original (liquid) 6. Peptac (liquid) 7. Gastrocote (liquid) 8. Gaviscon Advance (liquid)	6. Sodium Alginate 7. Sodium Alginate 8. Sodium Alginate
Tyrgat, G. & Simonneau, G.	2005	ANC	1. Rennie Duo (liquid) 2. Gaviscon Original (liquid) 3. Placebo (liquid)	1. Calcium Carbonate 2. Sodium Alginate 3. not mentioned
Detmar, P. W., et al.	2017	ANC	1. Rennie Duo (liquid) 2. Gaviscon Double Action (liquid) 3. Gaviscon Original (liquid) 4. Peptac (liquid) 5. Mylan Liquid Suspension (liquid) 6. Maalox RefluRAPID (liquid)	1. Calcium Carbonate 2. Sodium Alginate 3. Sodium Alginate 4. Sodium Alginate 5. Sodium Alginate 6. Sodium Alginate 7. Alginate Acid

			7. Algicon (solid)	
Mahmood, D., et al.	2020	ANC	1. Moxal Plus (solid) 2. Rennie Duo (solid) 3. Gaviscon Original (solid) 4. Gaviscon Advance (liquid) 5. Moxal (solid) 6. Gaviscon Original (liquid) 7. Moxal Plus (liquid) 8. Epicogel (liquid) 9. Moxal (liquid) 10. Mucogel (liquid) 11. Favlar lemon (effervescent powder)	1. Aluminum Hydroxide 2. Calcium Carbonate 3. Sodium Alginate 4. Sodium Alginate 5. Aluminum Hydroxide 6. Sodium Alginate 7. Aluminum Hydroxide 8. Aluminum Hydroxide 9. Aluminum Hydroxide 10. Aluminum Hydroxide 11. Sodium Bicarbonate

3.3 Antacid Component with Less Adverse Effects

The information collected, tabulated in Table 3, implies that in addition to Alginate being a suitable alternative to Aluminum Hydroxide in terms of high Acid Neutralization Capacity (ANC), Alginate also causes fewer adverse effects when taken by patients. Meaning, Alginate is also a suitable alternative to Aluminum Hydroxide and Calcium Carbonate for patients who choose to intake a more organic antacid component. Alginate is considered organic because it has Alginic Acid that is derived from brown seaweeds. Organic compounds contain more carbon and oxygen than inorganic compounds, these elements are already present within the biochemical makeshift of a human. Sodium Alginate is a raft-forming agent that



floats on top of the stomach which traps carbon dioxide. This raft stops incoming acidic gases that may worsen gastric pH. The raft gives gastric acid time to normalize before it eventually dissolves and gets digested.

Table 3. Resulting Efficacy of Antacids and their components based on Adverse Effects

Study	Year Published	Parameters Identified (ANC, adverse effects treatment)	Results (Highest Parameter to Lowest Parameter)	Components (of the corresponding antacids)
Sun, J., et al.	2015	Adverse effects	1. Gaviscon Double Action (solid) 2. Placebo (solid)	1. Sodium Alginate 2. not mentioned
Wilkinson, J., et al.	2019	Adverse effects	1. Gaviscon Double Action (liquid) 2. Placebo (liquid)	1. Sodium Alginate 2. not mentioned

3.4 Alginate and Calcium Carbonate as an alternative to Aluminum Hydroxide

The researchers evaluated the most effective chemical component, excluding Aluminum Hydroxide, in treating Gastroesophageal Reflux Disease (GERD) based on the resulting Acid Neutralization Capacity (ANC) and Adverse Effects among the accepted papers. Finding an alternative to Aluminum Hydroxide is significant because Aluminum Hydroxide can become toxic if built up in the body when intaking antacids. According to Dettmar et al., Hampson et al., Mahmood et al., and Tytgat & Simoneau, the most effective chemical component in treating GERD based on ANC is Calcium Carbonate. It is then followed by Alginate, more specifically Sodium Alginate. According to the studies of Sun et al. and Wilkinson et al., the most effective antacid component in treating GERD based on Adverse effects is Alginate. Overall, both Calcium Carbonate and Alginate are suitable alternatives to Aluminum Hydroxide.

4. CONCLUSIONS

The research aims to find the best alternative antacid component to Aluminum Hydroxide through a systematic literature review. Results from the eligible papers indicate that Calcium Carbonate has the highest Acid Neutralization Capacity (ANC), while Alginate, specifically Sodium Alginate, has fewer adverse effects than placebos. These results support

the claim that either Alginate or Calcium Carbonate are suitable alternative components to Aluminum Hydroxide in terms of ANC and adverse effects. The research findings suggest that Alginate and Calcium Carbonate can be an alternative to Aluminum Hydroxide. However, the potential of these components to completely replace Aluminum Hydroxide can be further looked into by future researchers. Also, it is recommended for future studies to explore other antacid components and different efficacy parameters to expand the scope of the study.

5. ACKNOWLEDGMENTS

The researchers would like to thank De La Salle University Integrated School for giving the researchers the opportunity to pursue this study. Moreover, this research would not be possible without the assistance and support provided by the research adviser, Miss Leah Madrazo. Her knowledge and expertise in the field of Science immensely helped in improving the manuscript.

6. REFERENCES

Ayensu, I., Bekoe, S. O., Adu, J. K., Brobbey, A. A., & Appiah, E. (2020). Evaluation of acid neutralizing and buffering capacities of selected antacids in Ghana. *Scientific African*, 8, e00347. <https://doi.org/10.1016/j.sciaf.2020.e00347>

Crisponi, G., Fanni, D., Gerosa, C., Nemolato, S., Nurchi, V. M., Crespo-Alonso, M., Lachowicz, J. I., & Faa, G. (2013). The meaning of aluminium exposure on human health and aluminum-related diseases. *Biomolecular Concepts*, 4(1), 77-87. <http://doi.org/10.1515/bmc-2012-0045>

Dettmar, P. W., Gil Gonzalez, D., Fisher, J., Flint, L., Rainforth, D., Moreno-Herrera, A., & Potts, M. (2018). A comparative study on the raft chemical properties of various alginate antacid raft forming products. *Drug Development and Industrial Pharmacy*, 44(1), 30-39. <https://doi.org/10.1080/03639045.2017.1371737>

Hampson, F. C., Jolliffe, I. G., Bakhtyari, A., Taylor, G., Sykes, J., Johnstone, L. M., & Dettmar, P. W. (2010). Alginate-antacid combinations: raft formation and gastric retention studies. *Drug development and industrial pharmacy*, 36(5), 614-623. <https://doi.org/10.3109/03639040903388290>



- Higgins, J. P. T. & Green, S. (2011). *Cochrane Handbook for Systematic Reviews of Interventions* Version 5.1.; The Cochrane Collaboration, 2011. Retrieved from <https://training.cochrane.org/handbook/current>
- Jensen-Jarolim, E. (2015). Aluminium in Allergies and Allergen immunotherapy. *World Allergy Organization Journal*, 8, 7. <https://dx.doi.org/10.1186/s40413-015-0060-5>
- Li, K., Wang, Z. F., Li, D. Y., Chen, Y. C., Zhao, L. J., Liu, X. G., Guo, Y. F., Shen, J., Lin, X., Deng, J., Zhou, R., & Deng, H. W. (2018). The good, the bad, and the ugly of calcium supplementation: a review of calcium intake on human health. *Clinical Interventions in Aging*, 13. 2443-2452. <https://dx.doi.org/10.2147%2FICIA.S157523>
- Mahmood, D., Alnaseer, S., Muhammad, B. Y., Khalilullah, H., Abdulghani, M. A., Anwar, M. J. Alenezi, S. K., Haider, M., & Elleban, N. (2020). Acid-neutralising capacity and pharmaco-economic studies of commercially available antacids in the Qassim Region of Saudi Arabia. *Hamdan Medical Journal*, 13(3), 150. https://doi.org/10.4103/HMJ.HMJ_10_20
- Salisbury, B. H., & Terrell, J.M. (2020). *Antacids: StatPearls* [Internet]. Treasure Island (FL): StatPearls Publishing; January 2021. Retrieved from: <https://www.ncbi.nlm.nih.gov/books/NBK526049>
- Shamseer, L., Moher, D., Clarke, M., Ghersi, D., Liberati, A., Petticrew, M., Shekelle, P., and Stewart, L. A. (2015). Preferred reporting items for systematic review and meta-analysis protocols (PRISMA-P) 2015: elaboration and explanation. *BMJ*, 349, 1-25. <https://doi.org/10.1136/bmj.g7647>
- Sollano, J. D., Wong, S. N., Andal-Gamutan, T., Chan, M. M., Carpio, R. E., Tady, C. S., Ismael, A. E., Judan-Ruiz, E. A., Ang, V. N., Go, J. T., Lim, V. Y., Perez, J. Y., & Alvarez, S. Z. (2007). Erosive esophagitis in the Philippines: A comparison between two time periods. *Journal of Gastroenterology and Hepatology*, 22(10), 1650-1655. <https://doi.org/10.1111/j.1440-1746.2006.04355.x>
- Sun, J., Yang, C., Zhao, H., Zheng, P., Wilkinson, J., Ng, B., & Yuan, Y. (2015). Retracted: Randomised clinical trial: the clinical efficacy and safety of an alginate-antacid (Gaviscon Double Action) versus placebo, for decreasing upper gastrointestinal symptoms in symptomatic gastroesophageal reflux disease (GERD) in China. *Alimentary pharmacology & therapeutics*, 42(7), 845-854. <https://doi.org/10.1111/apt.13334>
- Szekalska, M., Pucilowska, A., Szymańska, E., Ciosek, P., & Winnicka, K. (2016). Alginate: current use and future perspectives in pharmaceutical and biomedical applications. *International Journal of Polymer Science*, 2016. <http://doi.org/10.1155/2016/7697031>
- Tytgat, G. N., & Simoneau, G. (2005). Clinical and laboratory studies of the antacid and raft-forming properties of Rennie alginate suspension. *Alimentary pharmacology & therapeutics*, 23(6), 759-765. <https://doi.org/10.1111/j.1365-2036.2006.02814.x>
- Wilkinson, J., Abd-Elaziz, K., den Daas, I., Wemer, J., van Haastert, M., Hodgkinson, V., Foster, M. & Coyle, C. (2019). Two placebo-controlled crossover studies in healthy subjects to evaluate gastric acid neutralization by an alginate-antacid formulation (Gaviscon Double Action). *Drug development and industrial pharmacy*, 45(3), 430-438. <https://dx.doi.org/10.1080/03639045.2018.1546314>
- Yamamichi, N., Mochizuki, S., Asada-Hirayama, I., Mikami-Matsuda, R., Shimamoto, T., Konno-Shimizu, M., Takahashi, Y., Takeuchi, C., Niimi, K., Ono, S. & Kodashima, S. (2012). Lifestyle factors affecting gastroesophageal reflux disease symptoms: a cross-sectional study of healthy 19864 adults using FSSG scores. *BMC medicine*, 10(45). <https://dx.doi.org/10.1186/1741-7015-10-45>



A Systematic Review on the Effects of L-theanine and Caffeine Combination on Human Mood and Cognition

Kyra Dominique M. Andres, Angela Mae P. Corcuera,
Raissa Marie S. Macaraig and Marie Nicole Jade C. Mendoza
De La Salle University Integrated School, Manila

Abstract: Caffeine is one of the most widely ingested psychoactive drugs in the world. However, this central nervous system stimulant has raised concerns because of its inauspicious effects on health that come with its overconsumption. Recent scientific advancements have allowed for the theoretical regulation of these side effects through the combination of caffeine and L-theanine, an amino acid that promotes relaxation and improves mental function. This mini-review aims to extend current knowledge by synthesizing both beneficial and detrimental effects of the administration of the combination of caffeine and L-theanine to the human brain and cognition. Information was extensively reviewed, analyzed, and compiled from a sample of 50 works of literature published from 2014 to 2020 in the DLSU Library Databases, as well as referenced studies excluded from the given timeframe that contain highly relevant information that help structuralize the review. Dosage was found to be important in attaining benefits on mood and cognition such as suppressed anxiety and stress, positive mental state, neurochemically fostered changes in neurotransmitter systems, improved accuracy, improved semantic and recognition memory, and heightened mental alertness. On the other hand, L-theanine was found to reduce arousal more than it regulates elevated emotions caused by caffeine while some literature found that induced cognitive effects were only independent for each substance. In summary, existing studies support the hypothesis that the combination benefits human mood and cognition. As such, future research may gear towards a build-up on knowledge and innovations on the topic.

Key Words: L-theanine; caffeine; human cognition; mood

1. INTRODUCTION

1.1. Background of the Study

Caffeine is one of the most widely ingested psychoactive drugs worldwide. It is an alkaloid found in various plants synthetically manufactured for incorporation into beverages and supplements (Turnbull et al., 2017). The chemical structure of caffeine is very similar to that of adenosine, one of the breakdown products of the high-energy molecule adenosine triphosphate. The longer a person is awake, the higher the adenosine levels present in neurons which eventually attach to adenosine receptors causing sleepiness. Due to similarities, caffeine has the ability to block these receptors and counteract adenosine activities such as release of the inhibitory neurotransmitter gamma-aminobutyric acid (GABA) which inhibits arousal and wakefulness, and reduction of dopamine activity, which accounts for the feeling of pleasure, motivation, and enthusiasm, norepinephrine, which is associated with treating mood disorders, and glutamate, which is responsible for learning and memory (Ribeiro & Sebastião, 2010).

On the other hand, too many caffeine molecules blocking adenosine receptors may cause excitotoxicity or neuronal death processes (Simone et al., 2014), one of caffeine's inauspicious effects on health that come with its overconsumption.

Beverages such as tea have been popularly associated with relaxation due to an amino acid called L-theanine. It has beneficial bioactivities including "anti-cerebral ischemia-reperfusion injury, stress-reducing, antitumor, anti-aging, and anti-anxiety activities" (Saeed et al., 2017, p. 1261). Williams et al. (2016) claimed that L-theanine has generally proven to provide advantageous effects to cognitive functions including improved sleep quality and increased alertness. The chemical structure of L-theanine is very similar to that of glutamate, an excitatory neurotransmitter which, in excess, can lead to neuronal damage. Therefore, L-theanine can bind to glutamate receptors to antagonize fast synaptic transmission and agonize synaptic plasticity for learning and memory mechanisms (Adhikary & Mandal, 2017; Yamada et al., 2005). L-theanine also has the ability to elevate inhibitory neurotransmitters like serotonin and GABA, which causes a calming



effect, and reduces levels of excitatory brain chemicals linked to stress and anxiety. Most importantly, L-theanine enhances alpha brain waves which promote wakeful relaxation or relaxation without sedation (Dramard et al., 2018).

The presence of L-theanine in tea was found to help regulate the stimulation caused by caffeine, creating a synergistic effect that promotes different health benefits and minimizes health risks from its caffeine constituent (Dodd et al., 2015). This mini-review discusses both supporting and opposing findings of existing studies exploring the effects and benefits of the combination of caffeine and L-theanine, with the goal of synthesizing recent advancements regarding the understanding of this topic. Ultimately, the review aims to extend current knowledge on the topic by highlighting both beneficial and detrimental effects of L-theanine and caffeine administration on the human brain and cognition.

1.2. Research Objectives

This review aims to investigate the effects of caffeine, L-theanine, and their combination on human cognition by summarizing and evaluating the literature on the aforementioned topics. Furthermore, it aims to show relationships between studies discussing unclear and conflicting ideas. With this, the specific objectives are:

1.2.1 To provide an overview of current knowledge regarding the combination of caffeine and L-theanine on human cognition

1.2.2 To compare and contrast the findings of recent studies about the relationship of caffeine, L-theanine, and human cognition

1.2.3 To address whether or not the combination of caffeine and L-theanine is beneficial to human mood and cognition

1.3. Scope and Limitations

This mini-review focused on synthesizing the different effects of the combination of caffeine and L-theanine on different biological mechanisms of the human brain and cognition. Separate findings exploring effects of the combination were originally integrated into a single study and used in supporting other data and interpretations in the sample. Additionally, referenced studies outside the given timeframe containing highly relevant findings necessary to the review were mentioned.

The conclusions derived from this review were solely based on primary interpretations made in the sample studies and no further interpretations unsupported by published findings were made. Overall, this review provides a comprehensive chemistry-based categorical synthesis emphasizing common findings and contradictions present among recent studies on the topic.

1.4. Significance of the Study

Understanding the chemical structure of caffeine in combination with L-theanine creates a more detailed view of their impact on the human brain and cognition. Since L-theanine regulates the jolting effect of caffeine, enhances concentration, and increases relaxation without drowsiness, there is a heightened potential of how these components may help better obtain desired effects with minimal to no risks. Thus, this review will help achieve a better perspective on the combination of caffeine and L-theanine in terms of its chemical attribution to human mood and cognition.

2. METHODOLOGY

This review was conducted using the DLSU Library Databases and other electronic databases including Google Scholar, PubMed, and ProQuest Online. The search focused on different types of literature (original research, peer-reviewed articles, systematic reviews, etc.) published from 2014 to 2020. The keywords used in the search include L-theanine, theanine, caffeine, combination of caffeine and L-theanine, human cognition, human brain, and chemistry. Literature found in the initial search were further assessed whereas studies emphasizing relevant disciplines were included in the final sample. These disciplines include chemistry as the major discipline and biology and psychology as minor disciplines. A total of 50 works of literature were included and reviewed in the final sample.

3. RESULTS AND DISCUSSION

By itself, caffeine is thought to act as a central nervous system stimulant and has positive effects on cognitive and psychomotor functioning such as enhanced alertness, vigilance, reaction time, and memory function in both young and older adults (Waer et al., 2020). Contrarily, L-theanine is found to have an impact on mood, cognition, and human brain functions (Mancini et al., 2017).

Their combination has mostly been linked to the improvement of human cognitive function and mental clarity (Einother et al., 2010; Kahathuduwa et al., 2016; Haskell et al., 2008). However, there are also findings claiming that while it benefits the consumer, the effects are merely additive in that the effects are the same when the components are administered separately in similar dosages (Kahathuduwa et al., 2016). Saeed et al. (2017) also suggests that L-theanine inhibits the activation impact of caffeine on the problems of sleep.

Overall, the combination has both positive and negative effects, as well as promotional avenues that have yet to be extensively explored.



3.1. Beneficial effects of L-theanine and caffeine combination on the human brain and cognition

3.1.1 Mood

According to a study by Giles et al. (2017), “under emotional arousal, caffeine and theanine exert opposite effects on certain attentional processes, but when consumed together, they counteract the effects of each other”. Moreover, a study by Unno et al. (2017) found that the combination of the substances was effective for the specific suppression of anxiety which is linked to stress. Additionally, several articles and reviews further imply that the combination of these substances seem to enhance overall mood and have a positive effect on the subjects’ mental state. Similarly, Zaragoza et al. (2017) suggests the combination of caffeine and L-theanine have neurochemically fostered changes in neurotransmitter systems which include dopamine and serotonin that are responsible for pleasure, as well as stabilization of mood and happiness respectively.

3.1.2 Cognition

Reaction time, memory-retaining capacity, mental alertness, and attention were among the measures used to gauge the effectiveness of caffeine and L-theanine combination in cognition. Several studies including those conducted by Dodd et al. (2015), Einother et al. (2010), Camfield et al. (2014), and Giles et al. (2016) stated the effects of the combination in comparison to the effects of placebo. In summary, the studies concluded that there were relatively more beneficial effects on cognitive performance when consuming the combination than placebo.

Most studies highlight the importance of dosage when administering the substances together when analyzing their effect on cognition. Existing studies show that the highest dosage administered was 250mg L-theanine and 150mg caffeine, resulting in increased speed in accomplishing tasks as well as improvements in semantic memory and heightened alertness (Haskell et al., 2008). Dodd et al. (2015) revealed a 100mg:50mg combination improved accuracy, memory, and increased speed in attention-focused tasks, while Giles et al. (2016) cited the effectiveness of a 90-100mg:35-50mg and 50-100mg:75-100mg ratio in improving mental alertness and recognition memory. A 2.5mg/kg:2.0 mg/kg ratio also improved sustained attention and overall cognition acutely.

3.2. Toxicological effects of L-theanine and caffeine combination on the human brain and cognition

3.2.1 Mood

A study by Giles et al. (2016) tested the induction of negative emotions (e.g. anger, tension, etc.) in a psychologically aroused state wherein data showed participants had higher anger, confusion, vigor, tension, depression, and total mood disturbance rates 60-120 minutes following the administration of caffeine and L-theanine together and separately. Caffeine drives these mood effects; and although L-theanine may regulate these elevated emotions, it controls behavior less, obtains less relevant responses, and only reduces arousal in a stressful situation. On the contrary, according to Dekker et al. (2017), the combination was stated to have no definite impact on mood.

3.2.2 Cognition

Various data from studies and experiments on the effects of caffeine and L-theanine combination and its impact on cognition have been accumulated over the last few decades. Despite most studies claiming positive results of substances counteracting the effects of the other, there are some research specifying how cognitive benefits of the substances are independent of each other. According to Kelly et al. (2008, as cited in Giles et al., 2016), caffeine is mainly responsible for any beneficial determinants regarding attention, while L-theanine alone did not have any notable effects. Caffeine may also enhance cognitive performance, though in the long run may have consequences like impaired cognition (Giles et al., 2016). L-theanine was also found to inhibit caffeine and its activation effect on sleep problems (Saeed et al., 2017). Future studies have yet to assess the aforementioned, for most current studies state more favorable and significant effects for the substances combined.

3.3. Promotional avenues and commercialization aspects of the administration of L-theanine and caffeine combination

3.3.1 Vehicle of Administration

Tea, the main natural source of caffeine and L-theanine, is by far the most mentioned beverage across the reviewed studies. Since these components are known to have separate positive effects on human cognition and brain function, a variety of effective vehicles for their combination have been examined. A study by D’Cunha et al. (2020) suggests the ideal medium wherein effects may be optimally achieved is in pure encapsulated form, which induces better effects compared integration into food matrices. Dekker et al. (2017) mention its commercial



availability as a dietary supplement which “supports weight management, improves resting energy and mood states such as alertness, fatigue, and focus”. This study also acknowledges the current advertisement of these supplements as a “cognition and mood-enhancing substance”. However, there is a lack of a standardized dosage specialized according to certain soft biometric traits like body weight which may maximize effects on human cognition (D’Cunha et al., 2020). When the caffeine dose is higher than 75 mg per serving, the ability of L-theanine to decrease blood pressure becomes harder to accomplish (Dekker, et al., 2017). In relation to this, Giles et al. (2016) found that a 35-50mg to 90-100mg ratio of caffeine and L-theanine in tea exert similar benefits as having opposite concentrations which proves promising as a standardized dosage.

Several studies consistently show sensitivity of the combination to flavorings and other additional components for nutritional value which is perceived to improve sales. For instance, bitter matcha powder requires additional flavoring when used in products, limiting its functionality due to interference (Dekker et al., 2017). In fact, Antonio, et al. (2019) found that its anhydrous form is more capable of delivering enhanced endurance as opposed to its combination with other ingredients.

Baking is also accountable for a 19% decrease in total catechin content including epigallocatechin-3-gallate or EGCG which is the most abundant in tea, and epigallocatechin or EGC, both of which suppress cognitive dysfunction and improve memory functions and adaptive behavior, increase brain waves, and reduce stress. In combination, caffeine and EGCG suppress anti-stress effects of L-theanine while EGC and arginine retain these effects (Nakagawa et al., 2009). Therefore, more catechins improves stress reduction since it retains this effect of L-theanine by antagonizing caffeine’s.

Furushima et al. (2018) confirm that “differences in the quantities and ratios of green tea components affect the efficiency of its stress-reducing action” and suggest that more catechin improves stress reduction. It was also found that a caffeine and epigallocatechin gallate to theanine and arginine (CE/TA) molar ratio of two or less is crucial in overcoming the disadvantage of adding other ingredients and cooking (Furushima et al., 2019), therefore keeping the combination functional when used in food or beverages. Further research is needed to establish effects relative to the vehicle in which it is administered. Domain-specific concentration ratios of caffeine and L-theanine may also be established by adjusting within the standard range.

3.3.2 Domain-specific Uses

Three studies examined the potential of the combination in the clinical setting as a therapeutic agent for ADHD patients and an antidepressant. Blume, et al. (2019) report that the combination may serve as a pharmacological and dose-sparing agent or adjuvant to manage ADHD-associated cognitive deficits, complementing other current medications while Ayaz, et al. (2020) states its potential as a neuroprotective agent, playing a role in saving ischemic neurons in the brain from irreversible injury. A variant called Shaded White Tea Leaf (SWLT) was also found to have antidepressant effects due to its higher levels of caffeine and L-theanine (Furushima et al., 2020).

Zaragoza et al. (2019) focused on the commercialization of the combination in sports, suggesting that “supplementation with caffeine, theanine, and tyrosine could potentially hold ergogenic value for athletes in sports requiring rapid accurate movements,” and elaborating that athletes desiring maximized cognitive performance without altered mental state during training and competition could benefit from lower doses of caffeine within the combination.

4. CONCLUSIONS

The majority of existing studies conclude that the combination of caffeine and L-theanine gives rise to a number of benefits such as improvements in memory, alertness, switch tasks, speed, accuracy, and attention. These findings imply that the pair create a synergistic effect, giving off more nutritional advantages than when administered alone.

While some disadvantageous outcomes were recorded for the individual intake of these substances, their combination has favorable effects on mood and cognition, with only limited sources claiming negative effects when administered together. Although no toxicological effects have been precisely detected, additional research is still essential to better understand both short and long-term effects of the combination.

Consequently, more evidence is still necessary before its widespread application to clinical practice. Studies elaborating on the chemistry behind various concentration ratios and corresponding effects are necessary to support its potential as a pharmacological agent and allow development for further domain-specific specializations. Ultimately, this review may allow for future research to gear towards a build-up on knowledge and innovations on the topic.

5. ACKNOWLEDGMENTS

The success of this paper was made possible by the people who guided us throughout the process.



With that, we extend our gratitude and appreciation to the following people:

To our families who gave us support and encouragement, as well as assistance in the form of moral and emotional support.

To our friends and classmates who, like our family, served as reinforcement and aided us with examples and guidance when we needed help.

To our mentors, our adviser Dr. Roger Tan and research coordinator Ms. Liezl Rillera-Astudillo, for steering us in the right direction when we encountered difficulties.

To our academic institution, De La Salle University, for always giving us an opportunity to further our knowledge and instilling in us the power of research.

Last but not the least, God, for His shower of blessings throughout this undertaking.

6. REFERENCES

- Adhikary, R., & Mandal, V. (2017). L-theanine: A potential multifaceted natural bioactive amide as health supplement. *Asian Pacific Journal of Tropical Biomedicine*, 7(9), 842–848. <https://doi.org/10.1016/j.apjtb.2017.08.005>
- Anstice, N., D' Cunha, N. M., Everett, J. M., Georgousopoulou, E. N., Keegan, R. J., McKune, A. J., Mellor, D. D., Naumovski, N., Sergi, D., & Williams, J. L. (2019). The effects of green tea amino acid L-theanine consumption on the ability to manage stress and anxiety levels: a systematic review. *Plant Foods for Human Nutrition*, 75, 12–23. <https://doi.org/10.1007/s11130-019-00771-5>
- Anstice, N., D' Cunha, N. M., McKune, A., Naumovski, N., & Williams, J. (2020). Effect of green tea amino acid L-theanine on physiological responses: a protocol for clinical trial. *Exploratory Research and Hypothesis in Medicine*. <https://doi.org/10.14218/ERHM.2020.00048>
- Antonio J., & Ellerbroek A. C. (2019). Effects of pre-workout supplements on strength, endurance, and mood. *Internet Journal of Allied Health Sciences and Practice*, 17(1). <https://nsuworks.nova.edu/ijahsp/vol17/iss1/7/>
- Ashfiqu, R., Artyom, Z., Özdem Ceyona, Sohel, R. M., & Al-Amin, M. (2017). The effect of black tea on human cognitive performance in a cognitive test battery. *Clinical Phytoscience*, 3(1). <http://doi.org.dlsu.idm.oclc.org/10.1186/s40816-017-0049-4>
- Ayaz, H., Sargent, A., Suri, R., Topoglu, Y., Watsons, J., & Ye, H. (2020). Impact of tea and coffee consumption on cognitive performance: an fNIRS and EDA study. *Applied Sciences*, 10(7), 2390. <https://doi.org/10.3390/app10072390>
- Barulli, M. R., Bonfiglio, C., Guerra, V., Logroscino G., Osalle, A., Panza F., Pilotto, A., Sabbà, C., Seripa, D., & Solfrizzi, V. (2014). Coffee, tea, and caffeine consumption and prevention of late-life cognitive decline and dementia: A systematic review. *The Journal of Nutrition, Health & Aging*, 19, 313–328. <https://doi.org/10.1007/s12603-014-0563-8>
- Binks, M., Chin, S., Dassanayake, T. L., Davis, T., Dhanasekara, C. S., Kahathuduwa, C. N., & Weerasinghe, V.S. (2018). L-theanine and caffeine improve target-specific attention to visual stimuli by decreasing mind wandering: a human functional magnetic resonance imaging study. *Nutrition Research*, 49, 67–78. <https://doi.org/10.1016/j.nutres.2017.11.002>
- Blume, J., Dassanayake, T. L., Kahathuduwa C. N., Mastergeorge, A., Wakefield, S., Weerasinghe, V. S., & West, B. D. (2020). Effects of L-theanine-caffeine combination on sustained attention and inhibitory control among children with ADHD: a proof-of-concept neuroimaging RCT. *Scientific Reports*, 10. <https://doi.org/10.1038/s41598-020-70037-7>
- Blume, J., Kahathuduwa, C., Mastergeorge, A., Wakefield, S., & West, B. (2019). L-theanine and caffeine improve sustained attention, impulsivity and cognition in children with attention deficit hyperactivity disorders by decreasing mind wandering. *Current Developments in Nutrition*, 3(1). <https://doi.org/10.1093/cdn/nzz031.0R29-04-19>
- Bobe, J., Golden, E., Johnson, M., Jones, M., Viglizzo, R., & Zimmerman, N. (2020). Measuring the effects of caffeine and L-theanine on cognitive performance: a protocol for self-directed, mobile N-of-1 studies. *Frontiers in Computer Science*, 2. <https://doi.org/10.3389/fcomp.2020.00004>
- Boros, K., Csupor, D., & Jedlinzski, N. (2016). Theanine and caffeine content of infusions prepared from commercial tea samples. *Pharmacognosy Magazine*, 12(45), 75–79. <https://doi.org/10.4103/0973-1296.176061>
- Bowerbank, S. L., Dodd, F. L., Forster, J. S., Haskell-Ramsay, C. F., Jackson, P. A., & Kennedy, D. O. (2018). The acute effects of caffeinated black coffee on cognition and mood in healthy young and older adults. *Nutrients*, 10(10), 1386. <https://doi.org/10.3390/nu10101386>
- Boyle, N.B., Dye, L., & Lawton, C. L. (2018). The effects of carbohydrates, in isolation and combined with caffeine, on cognitive performance and mood—current evidence and future directions. *Nutrients*, 10(2), 192. <https://doi.org/10.3390/nu10020192>
- Camfield, D. A., Pase M., Pipingas, A., Scholey, A., Stough, C. (2015). Herbal extracts and nutraceuticals for cognitive performance. In Best, T., & Dye, L. (Eds.), *Nutrition for Brain Health and Cognitive Performance* (pp. 221–244). Taylor & Francis Group.
- Camfield, D. A., Stough, C., Farrimond, J., & Scholey, A. B. (2014). Acute effects of tea constituents L-theanine, caffeine, and epigallocatechin gallate on cognitive function and mood: a systematic review and meta-analysis. *Nutrition Reviews*, 72(8), 507–522. <https://doi.org/10.1111/nure.12120>
- Chang, C., Jan, M., Wang, S., & Wang, W. (2017). Effect of black tea consumption on radial blood pulse spectrum and cognitive health. *Complementary Therapies in Medicine*, 31. <https://doi.org/10.1016/j.ctim.2017.01.001>
- Che Din, N., Haron, H., Rosli, H., & Shahar, S. (2014). Dietary polyphenols consumption and its relation with cognitive and mental health in aging: a review. *Malaysian Journal of Health Sciences*, 12(2). <http://doi.org/10.17576/JSKM-2014-1202-01>
- D' Cunha, N. M., Georgousopoulou, E. N., Kellet, J., McKune A. J., Mellor, D., Naumovski, N., Sergi, D., & Williams, J. (2020). The effect of L-theanine incorporated in a functional food product (mango sorbet) on physiological responses in healthy males: a pilot randomised controlled trial. *Foods*, 9(3), 371. <https://doi.org/10.3390/foods9030371>
- Dekker, M., & Dietz, C. (2017). Effect of green tea phytochemicals on mood and cognition. *Curr Pharm Des*, 23(19), 2876–2905. <https://doi.org/10.2174/1381612823666170105151800>
- Dekker, M., Dietz, C., & Piqueras-Fiszman, B. (2017). An intervention study on the effect of matcha tea, in drink and snack bar formats, on mood and cognitive performance. *Food Research International*, 99(1), 72–83. <https://doi.org/10.1016/j.foodres.2017.05.002>
- De Klerk, S., Gondalie, S., Noonan, C., Scholey, A. B., White, D. J., Woods, W. (2016). Anti-stress, behavioural and magnetoencephalography effects of an L-theanine-based nutrient drink: a randomised, double-blind, placebo-controlled, crossover trial. *Nutrients*, 8(1). <https://doi.org/10.3390/nu8010053>
- Dodd, F. L., Kennedy, D. O., Riby, L. M., & Haskell-Ramsay, C. F. (2015). A double-blind, placebo-controlled study evaluating the effects of caffeine and L-theanine both alone and in combination on cerebral blood flow, cognition and mood. *Psychopharmacology*, 232(14), 2563–2576. <https://doi.org/10.1007/s00213-015-3895-0>
- Dodd, F. L., Kennedy, D. O., Riby, L. M., Wilde, A., & Haskell, C. F. (2011). An evaluation of the cerebral blood flow, cognitive and mood effects of caffeine and L-theanine both alone and in combination. *Appetite*, 57(2), 557. <https://doi.org/10.1016/j.appet.2011.05.068>
- Dramard, V., Kern, L., Hofmans, J., Rème, C. A., Nicolas, C. S., Chala, V., & Navarro, C. (2018, October 9). Effect of L-theanine tablets in reducing stress-related emotional signs in cats: an open-label field study. *Irish veterinary journal*. <https://www.ncbi.nlm.nih.gov/pmc/articles/PMC6178259/>
- Duong, J., Gibson, A. (2014). L-theanine and caffeine's effect on cognitive performance in terms of short term memory. *Broncho Scholar*. <http://hdl.handle.net/10211.3/118441>
- Einöther, S. J. L., Martens, V. E. G., Rycroft, J. A., & De Bruin, E. A. (2010). L-theanine and caffeine improve task switching but not intersensory attention or subjective alertness. *Appetite*, 54(2), 406–409. <https://doi.org/10.1016/j.appet.2010.01.003>



- Ezaki, Y., Fukushima, Y., Hisatsune, T., Inamura, N., Masuoka, N., Sakurai, K., & Shen, C. (2020). Effects of matcha green tea powder on cognitive functions of community-dwelling elderly individuals. *Nutrients*, 12(12), 3639. <https://doi.org/10.3390/nu12123639>
- Forster, J., Haskell-Ramsay, C. F., Jackson, P. A., Kennedy, D. O., Khan, J., & Whitman, E. L. (2017). Cognitive and mood effects of a nutrient enriched breakfast bar in healthy adults: a randomised, double-blind, placebo-controlled, parallel groups study. *Nutrients*, 9(12), 1832. <https://doi.org/10.3390/nu9121832>
- Foxe, J. J., Morie, K. P., Laud, P. J., Rowson, M. J., de Bruin, E. A., & Kelly, S. P. (2012). Assessing the effects of caffeine and theanine on the maintenance of vigilance during a sustained attention task. *Neuropharmacology*, 62(7), 2320–2327. doi:10.1016/j.neuropharm.2012.01.020
- Fukura, K., Sakamoto, K., Suzuki, M., Takeda, A., Tamano, H., & Yokogoshi, H. (2014). Advantageous effect of theanine intake on cognition. *Nutritional Neuroscience*, 17(6), 279–283. <https://doi.org/10.1179/1476830513Y.0000000094>
- Furushima, D., Hamamoto, S., Horoe, H., Iguchi, K., Morita, A., Nakamura, Y., Unno, K., & Yamada, H. (2018). Stress-reducing function of matcha green tea in animal experiments and clinical trials. *Nutrients*, 10(10), 1468. <https://doi.org/10.3390/nu10101468>
- Furushima, D., Hamamoto, S., Horoe, H., Iguchi, K., Morita, A., Nakamura, Y., Unno, K., & Yamada, H. (2019). Stress-reducing effect of cookies containing matcha green tea: essential ratio among theanine, arginine, caffeine and epigallocatechin gallate. *Heliyon*, 5(5), e01653. <https://doi.org/10.1016/j.heliyon.2019.e01653>
- Furushima, D., Iguchi, K., Nakamura, Y., Nomura, Y., Ozeki, M., Suzuki, T., Taguchi, K., Unno, K., & Yamada, H. (2020). Antidepressant Effect of Shaded White Leaf Tea Containing High Levels of Caffeine and Amino Acids. *Molecules*, 25(15), 3550. <https://doi.org/10.3390/molecules25153550>
- Gilbert, N. (2019). Drink tea and be merry. *Nature*, 566(7742), 463. <http://doi.org.dlsu.idm.oclc.org/10.1038/d41586-019-00398-1>
- Giles, G. E., Mahoney, C. R., Brunyé, T. T., Taylor, H. A., & Kanarek, R. B. (2016). Caffeine and theanine exert opposite effects on attention under emotional arousal. *Canadian Journal of Physiology and Pharmacology*, 95(1), 93–100. <https://doi.org/10.1139/cjpp-2016-0498>
- Haskell, C. F., Kennedy, D. O., Milne, A. L., Wesnes, K. A., & Scholey, A. B. (2008). The effects of l-theanine, caffeine and their combination on cognition and mood. *Biological Psychology*, 77(2), 113–122. <https://doi.org/10.1016/j.biopsycho.2007.09.008>
- Health benefits and chemical composition of matcha green tea: A review. (2021). *Molecules*, 26(1), 85. <http://doi.org.dlsu.idm.oclc.org/10.3390/molecules26010085>
- Hidese, Ogawa, Ota, Ishida, Yasukawa, Ozeki, & Kunugi. (2019). Effects of l-theanine administration on stress-related symptoms and cognitive functions in healthy adults: a randomized controlled trial. *Nutrients*, 11(10), 2362. <https://doi.org/10.3390/nu11102362>
- Kahathuduwa, C.N., Dassanayake, T. L., Amarakoon, A. M. T., & Weerasinghe V. S. (2016). Acute effects of theanine, caffeine and theanine-caffeine combination on attention. *Nutritional Neuroscience*, 20(6), 369–377. <https://doi.org/10.1080/1028415X.2016.1144845>
- Kahathuduwa, C. N., Wakefield, S., West, B. D., Blume, J., Dassanayake, T. L., Weerasinghe, V. S., & Mastergeorge, A. (2020). Effects of l-theanine-caffeine combination on sustained attention and inhibitory control among children with ADHD: a proof-of-concept neuroimaging RCT. *Scientific Reports*, 10(1). <https://doi.org/10.1038/s41598-020-70037-7>
- Kellett, J., Mellor, D., McKune, A., Naumovski, N., Roach, P.D., Thomas, J., & Williams, J. (2016). L-theanine as a functional food additive: its role in disease prevention and health promotion. *Beverages*, 2(2), 13. <https://doi.org/10.3390/nu10101468>
- Mancini, E., Beglinger, C., Drewe, J., Zanchi, D., Lang, U., Borgwardt, S. (2017). Green tea effects on cognition, mood and human brain function: A systematic review. *Phytomedicine*, 34, 26–37. <https://doi.org/10.1016/j.phymed.2017.07.008>
- Masley, S. (2018). Lifestyle approaches to prevent and manage cognitive impairment. *Primary Care Reports*, 24(2) <https://search.proquest-com.dlsu.idm.oclc.org/trade-journals/lifestyle-approaches-prevent-manage-cognitive/docview/1993919448/se-2?accountid=190474>
- Nakagawa, K., Nakayama, K., Nakamura, M., Sookwong, P., Tsuduki, T., Niino, H., ... Miyazawa, T. (2009). Effects of Co-Administration of Tea Epigallocatechin-3-gallate (EGCG) and Caffeine on Absorption and Metabolism of EGCG in Humans. *Bioscience, Biotechnology, and Biochemistry*, 73(9), 2014–2017. <https://doi.org/10.1271/bbb.90195>
- Rogers, P. J., Smith, J. E., Heatherley, S. V., & Pleydell-Pearce, C. W. (2007). Time for tea: mood, blood pressure and cognitive performance effects of caffeine and theanine administered alone and together. *Psychopharmacology*, 195(4), 569–577. <https://doi.org/10.1007/s00213-007-0938-1>
- Ribeiro, J. A., & Sebastião, A. M. (2010). Caffeine and Adenosine. *Journal of Alzheimer's Disease*, 20(s1). <https://doi.org/10.3233/jad-2010-1379>
- Saeed, M., Naveed, M., Arif, M., Kakar, M. U., Manzoor, R., Abd El-Hack, M. E., ... Sun, C. (2017). Green tea (camellia sinensis) and l-theanine: medicinal values and beneficial applications in humans—a comprehensive review. *Biomedicine & Pharmacotherapy*, 95, 1260–1275. <https://doi.org/10.1016/j.biopha.2017.09.024>
- Schuster, J., Mitchell, E. (2019). More than just caffeine: psychopharmacology of methylxanthine interactions with plant-derived phytochemicals. *Progress in Neuro-Psychopharmacology and Biological Psychiatry*, 89, 263–274. <https://doi.org/10.1016/j.pnpbp.2018.09.005>
- Sharma, E., Joshi, R., Gulati, A. (2018). L-theanine: an astounding sui generis integrant in tea. *Food Chemistry*, 242, 601–610. <https://doi.org/10.1016/j.foodchem.2017.09.046>
- Shu-Qing, C., Ze-Shi Wang, Yi-Xiao, M., Zhang, W., Jian-Liang, L., Yue-Rong, L., & Xin-Qiang, Z. (2018). Neuroprotective effects and mechanisms of tea bioactive components in neurodegenerative diseases. *Molecules*, 23(3), 512. <http://doi.org.dlsu.idm.oclc.org/10.3390/molecules23030512>
- Simone, C., Daria, P., Gabriele, S., & Mariarosaria, A. (2014, December 31). Caffeine: Cognitive and Physical Performance Enhancer or Psychoactive Drug? <https://www.eurekaselect.com>. <https://dx.doi.org/10.2174%2F1570159X13666141210215655>.
- Turnbull, D., Rodricks, J. V., Mariano, G. F., & Chowdhury, F. (2017). Caffeine and cardiovascular health. *Regulatory Toxicology and Pharmacology*, 89, 165–185. <https://doi.org/10.1016/j.yrtph.2017.07.025>
- Unno, K., Hara, A., Nakagawa, A., Iguchi, K., Ohshio, M., Morita, A., Nakamura, Y. (2016). Anti-stress effects of drinking green tea with lowered caffeine and enriched theanine, epigallocatechin and arginine on psychosocial stress induced adrenal hypertrophy in mice. *Phytomedicine*, 23(12), 1635–1374. <https://doi.org/10.1016/j.phymed.2016.07.006>
- Unno, K., Yamada, H., Iguchi, K., Ishida, H., Iwao, Y., Morita, A., Nakamura, Y. (2017). Anti-stress effect of green tea with lowered caffeine on humans: a pilot study. *Biological and Pharmaceutical Bulletin*, 40(6), 902–909. <https://doi.org/10.1248/bpb.b17-00141>
- Waer, F., Laatar, R., Jouira, G., Srihi, S., Rebai, H., Sahli, S. (2021). Functional and cognitive responses to caffeine intake in middle-aged women are dose depending. *Behavioural Brain Research*, 397. <https://doi.org/10.1016/j.bbr.2020.112956>
- Williams, J., Kellett, J., Roach, P., McKune, A., Mellor, D., Thomas, J., & Naumovski, N. (2016). L-theanine as a functional food additive: its role in disease prevention and health promotion. *Beverages*, 2(2). <https://doi.org/10.3390/beverages2020013>
- Yamada, T., Terashima, T., Okubo, T., Juneja, L. R., & Yokogoshi, H. (2005). Effects of theanine, r-glutamylethylamide, on neurotransmitter release and its relationship with glutamic acid neurotransmission. *Nutritional Neuroscience*, 8(4), 219–226. <https://doi.org/10.1080/10284150500170799>
- Zaragoza, J., Tinsley, G., Urbina, S., Villa, K., Santos, E., Juaneza, A., Tinnin, M., Davidson, C., Mitmesser, S., Zhang, Z., & Taylor, L. (2019). Effects of acute caffeine, theanine and tyrosine supplementation on mental and physical performance in athletes. *Journal of the International Society of Sports Nutrition*, 16(1). <https://doi.org/10.1186/s12970-019-0326-3>



Wound Healing Activity of Herbal Ointment Containing the Ethanolic Leaf Extract of Gumamela (*Hibiscus rosa-sinensis*)

Marjorie Lama Gutierrez, Sharmine Mae Cabangangan Algonos,
Isabella May Viado Andres and Jason Romeral Tabun-tabon
Taytay Senior High School, Taytay, Rizal

Abstract: The wound healing process is a multi-step cellular and biochemical process. For wound healing, antibiotics; preservatives; desalination agents; chemicals; and others are used. Some of these synthetic drugs are limited due to side effects. For this reason, the use of medicinal plants for wound healing has increased in popularity over the years due to the reduction of side effects. In fact, previous studies proved that *Hibiscus rosa-sinensis* (gumamela) extract can be used to treat wounds. Thus, the purpose of this study intends to evaluate the wound healing potentials of the formulated herbal ointment containing the gumamela ethanolic leaf extracts. The gumamela leaf ethanolic extract was mixed into the ointment foundation. The herbal ointment was then formulated. For the wound healing study, untreated and gumamela ointment treated wounds of albino mouse were observed to have a comparison after the experimentation. The physicochemical parameters of gumamela ointment including color, odor, washability, solubility, consistency, and pH level were all evaluated, and the results were satisfactory. Throughout the experimental period, there was a larger wound closure percentage in the wound treated with gumamela ointment as compared to the untreated. Hence, this finding clearly indicates that the ointment containing the gumamela leaf extract can enhance the healing of a wound as indicated by improved rates of wound closure.

Key Words: hibiscus rosa-sinensis; gumamela ointment; wound healing activity; wound splint model; ethanolic leaf extract

1. INTRODUCTION

According to Farahpour et al. (2019), the wound healing process is known as a cellular and biochemical interdependent step aimed at wound healing. Many individual herbal & multi-herbal compositions have been reported to accelerate wound healing in wound models. In fact, it has been scientifically proven that gumamela is used for wound healing (Shen et al., 2017). It is an ornamental plant that grows in China as an evergreen herb. It's only form, consisting of five red petals, is an ornamental mallow shrub from East Asia (Kitayima et al., 2010).

1.1. Theoretical Framework

As contested by Boateng et al. (2008), for wound healing; antibiotics, preservatives, desalination agents, chemicals and others are used. Some of these synthetic drugs are limited due to side effects. For this reason, the use of medicinal plants for wound healing has increased in popularity over the years due to the reduction of side effects and wound care (Farahpour et al., 2019). According to the findings of Al-Snafi et al. (2018), gumamela extract may be used to treat wounds. Kumar et al. (2012) claimed that this plant has various pharmacological activities that

can be used in various medical applications. For this reason, this study intends to validate the potential of the newly developed wound healing ointment containing the gumamela leaf extract.

1.2. Research Questions

What are the physicochemical parameters necessary in the evaluation of gumamela herbal ointment?

Does the gumamela herbal ointment show potential in healing wounds?

1.3. Scope and Delimitation

This study will focus on evaluating the wound healing potential of the formulated herbal ointment containing gumamela ethanolic leaf extracts. The objective of this study is limited since the other possible medicinal properties including the antibacterial activity of the ointment will not be studied. This study is also limited due to the use of a small sample size (1 albino mouse). Moreover, there was no positive control used in the treated and controlled experiment.

2. METHODOLOGY

Experimental research design is motivated by hypotheses, and statistical analysis is used to confirm or disprove a theory (Nunmaker et al., 2001). It is the most precise type of experimental design and can be performed on at least two randomly assigned dependent subjects with or without a pretest. The researchers used posttest only control design. The posttest-only control design is a study in which at least two groups are used, one of which does not receive a treatment or intervention, and data on the outcome measure is obtained after the treatment or intervention. The researchers used 1 albino male mouse. The untreated and gumamela ointment treated wounds of the mouse were observed to have a comparison after the experimentation.

2.1. Sampling Procedure

The researchers obtained a 27g 1 male albino mouse (*Mus musculus*) from the pet shop located at Dolores, Taytay, Rizal. albino rats were used for this study because it represents a cost-effective animal model that is easy to genetically modify for mechanistic research.

2.2. Ethical Consideration

To ensure the safety of the subject (albino mouse) the researchers seek technical assistance from a professional veterinary doctor to do the excision wounds on albino mouse. The researchers also assure that in line with this activity, precautionary actions were considered such as taking care of the subject with the intention that no subject will be exterminated. Moreover, proper handling protocols were observed for the safety of the researchers from getting bitten by the subject.

2.3. Proposed Product

Figure 1
Formulated gumamela ointment



2.4. Procedures

2.4.1. Preparation of gumamela Leaf Ethanollic Extract

Gumamela leaves were collected and thoroughly washed with distilled water to clean the adhering dust particles. After collecting and washing, the leaves were dried under the shade until they dried. The dried leaves were ground into powder with the aid of an electric blender. Thereafter, the 100g powder was imbibed with 350ml of 90% ethanol for 3 hours and moved to an airtight container of 150ml 90% ethanol for 7 days of maceration with occasional stirring. Finally, the Ethanollic extract of gumamela leaves was collected and condensed to produce a blackish green residue, which was then filtered using the simple filtration process. The extract was kept in an airtight container in a cold, dark place.

2.4.2. The procedure for making herbal ointment is as follows:

- A. To make the ointment base, weigh precisely grated hard paraffin wax (25g) and place it in an evaporating dish over a water bath. The other ingredients (50g of petroleum jelly and 20ml of coconut oil) was added after the hard paraffin had melted, and gently stirred to aid melting and homogeneous mixing until the ointment base had cooled.
- B. To make gumamela ointment, weigh the gumamela ethanollic leaf extract (5ml) and blend it into the ointment base to make a smooth paste. Gradually add more base until the ointment is homogeneous.

2.4.3. The following physicochemical parameters were used for the evaluation of the ointment:

Color & odor

Visual inspection was used to check the color and odor of the prepared ointment.

pH

The pH of ointment was determined using pH paper.

Solubility

The ointment was observed if it is soluble in water and alcohol.

Washability

After applying the ointment formulation to the skin, the degree to which it could be washed away with water was determined.

Consistency

Smooth and no greediness were observed.

2.4.4. Excisional wound splinting procedure:

Wound healing activities were evaluated using the mouse excisional wound splinting model. The albino mouse was anesthetized prior to creation of the wounds. Subcutaneous injection of 50 mg/ml intravenous Tiletamine-Zolazepam was used. The dorsal fur of the animal was shaved using a razor

blade. Two excision wounds were made using a biopsy punch to cut away a 6mm diameter length full thickness of skin from the dorsal area. Two silicon discs were adhered to the skin around the wound and sutured in place, preventing local skin contraction. After suturing, the wounds were covered with bandages. The animal was placed in a clean plastic cage. The wounds of the mouse were treated topically and categorized as untreated wound and wound with gumamela ointment. The wound area was measured on the first, 6th, 8th, 10th, & 12th day post-surgery.

2.5. Experimental model

Figure 2

Excisional wound splinting model

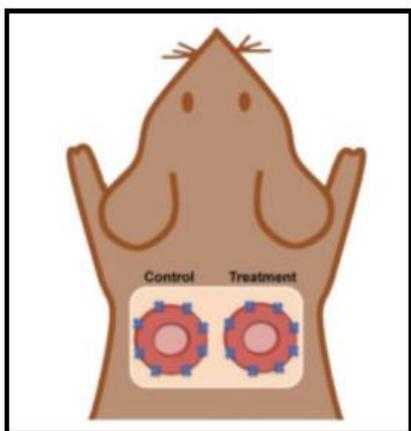

The researchers used the excisional wound splinting wound healing model in albino mouse (*Mus musculus*). Two full-thickness wounds are produced on either side of the mouse's dorsal region in this model. Silicone splints are adhered and sutured to the wound's perimeter, creating a human-like model (Dunn et al., 2013). According to Wang et al., (2013), Mouse' wounds heal differently to humans, primarily due to the process of contraction. This is in part, due to an extensive subcutaneous striated muscle layer called the 'panniculus carnosus' that is largely absent in humans. In mice, this muscle layer allows the skin to move independently of the deeper muscles and is responsible for the rapid contraction of skin following wounding. To overcome this limitation, the researchers used the excisional wound splinting wound healing model in albino mouse. The use of silicone splints is to allow the re-epithelialization and new tissue formation, a key feature of this model, which is analogous to what happens in humans.

2.6. Data Analysis Procedure

For the wound healing study, the albino mouse was wounded as part of the experimentation. Two wounds were characterized as treated (wound with gumamela ointment) and negative controlled

(wound with no treatment). The untreated and treated wounds were observed to have a comparison after the experimentation.

2.7. Instruments

Between the first day and 12 post-surgery, the researchers used an observation sheet to record the untreated and treated wound areas of the albino mice. To determine the wound area: the diameter (mm) of each wound was measured and was then computed using the formula of πr^2 . After that, the percentage of wound closure was computed as follows: (area of original wound – area of current wound) / area of original wound x 100

3. RESULTS AND DISCUSSION

3.3. What are the physicochemical parameters necessary in the evaluation of gumamela herbal ointment?

The following physicochemical parameters were used for the evaluations of the ointment:

Table 1
Physicochemical evaluation of the formulated gumamela ointment

Physicochemical parameters	Observations
1. color	Ocado green
2. odor	Characteristic
3. pH level	pH level of 5
4. consistency	Smooth
5. washability	Good
6. solubility	Soluble in water and alcohol

Physicochemical parameters including color, odor, washability, solubility, consistency, and pH level were all evaluated, and the results were satisfactory.

Color & odor

Visual inspection was used to check the color and odor of the prepared ointment.

pH level

The pH level of ointment was determined using pH paper. A little amount of ointment was wiped on the pH strip. The paper turned into a color yellow orange which indicates a pH level of 5.

Solubility

The ointment was observed if it is soluble in water and alcohol.

Washability

After applying the ointment formulation to the skin, the degree to which it could be washed away with water was determined.

Consistency

Smooth and no greediness were observed

3.2. Does the gumamela herbal ointment show potential in healing wounds?

In this finding, the researchers presented table and figures which show the observed albino mouse's wound area and wound closure percentage from day 0, day 6, day 8, day 10 and day 12. They are presented in order to have a comparison between the wound with gumamela ointment and the untreated.

Table 2
Wound area of the treated and untreated wound

	Wound Area (mm ²)				
	DAY 0	DAY 6	DAY 8	DAY 10	DAY 12
Treated (gumamela Ointment)	28.27 mm ²	23.76 mm ²	12.57mm ²	5.94mm ²	0 mm ²
Untreated	28.27 mm ²	28.27 mm ²	23.76 mm ²	9.62mm ²	4.91 mm ²

Throughout the experimental period, there was a larger decrease in the area of the wound treated with gumamela ointment as compared to the untreated wound.

Figure 3
Representative percentage of wound closure graph

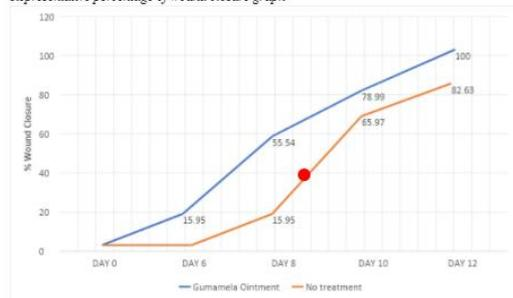

The researchers calculated (area of original wound – area of current wound) / area of original wound x 100 as the percentage of wound closure (Wang et al., 2013). There was a day-by-day increase in the wound closure percentage of the untreated and wound treated with gumamela ointment. However, the untreated wound closure percentage was less remarkable as compared to the wound closure percentage of gumamela ointment treated wound. The graph shows that by the 10th day of post-surgery, 78.99% of wound closure was observed on the wound with gumamela ointment while the untreated wound had only 65.97% of wound closure. Hence, the findings of this study clearly indicate that the ointment containing gumamela leaf extract can enhance the closure of a wound.

Figure 4
Wound healing activity on experimental mouse using wound splint model

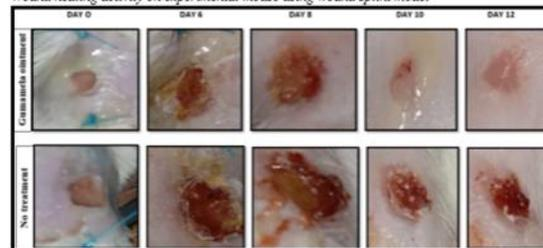

Throughout the experimental phase, the two wounds showed a day-by-day wound closure. However, the wounds treated with gumamela ointment were observed to show a more significant increase in wound healing activity as compared with untreated wounds. For the wound treated with gumamela ointment, a sharp decrease in the wound area was observed between the 6th & 12th after surgery, while a gradual reduction in the untreated wound area was recorded between days 6 & 12. The changes in the wound area as measured on days 0, 6, 8, 10, & 12 post surgery are shown in Table 2. Hence, this finding clearly indicates that the ointment containing the gumamela leaf extract can enhance the healing of a wound as indicated by improved rate wound closure.

Wound healing is a normal process in which dermal and epidermal tissues regenerate. When a wound occurs, a series of simultaneous events occur to repair the injury (Iba et al., 2004). There are three stages of these processes: inflammatory, proliferative, and remodeling (Stadelmann et al., 1998). In the inflammatory phase, bacteria and debris are phagocytosed and removed, while in the proliferative phase, cytokines and mediators are released, triggering cell migration and division. Angiogenesis, collagen deposition, granulation tissue development, epithelialization, and wound contraction are all part of the proliferative method (Midwood et al., 2004). During epithelialization, epithelial cells crawl across the wound bed to cover it (Garg, 2000).

4. CONCLUSIONS

The ethanolic leaf extract of gumamela was tested for wound healing operation. When the extract was mixed into the ointment foundation, the activity was preserved for topical use in the treatment of wounds. Its physicochemical parameters including color, odor, washability, solubility, consistency, and pH level were all evaluated, and the results were satisfactory.

Throughout the experimental period, there was a larger wound closure percentage in the wound treated with gumamela ointment as compared to the untreated one. Hence, this finding clearly indicates



that the ointment containing the gumamela leaf extract can enhance the healing of a wound as indicated by improved rates of wound closure.

4.1 Recommendations

The researchers would like to advise potential researchers who would use this study as a guide to use a larger sample size (more than two albino mice as an experimental model) because using a larger sample size in an experiment would make it less likely to draw an incorrect conclusion. They could also conduct a positive control on their experiment in order to obtain more reliable results.

5. ACKNOWLEDGMENTS

The researchers wanted to express their gratitude and appreciation towards Dr. Ma. Victoria C. Magayon & Mr. Dante Panalangin Jr. for their continuous support, encouragement, and learning opportunities provided. The researchers would also like to offer their gratitude towards Immanuel Rei L. Rombaoa, DVM, the veterinary doctor who administered the excision wound healing on the subject (albino mouse).

The completion of this project could not have been accomplished without the moral support of our family and friends. And most especially to GOD who provides guidance, wisdom, & strength to pursue this study.

6. REFERENCES

Ali, M. & Ansari, S. H. (1997). Hair care and herbal drugs, *Indian Journal of Natural products*, Vol-13, 3-5.

Bahmani, M., Saki, K., Rafieian-Kopaei, M., Karamati, S. A., Eftekhari, Z., & Jelodari, M. (2014). The most common herbal medicines affecting *Sarcomastigophora* branches: a review study. *Asian Pacific journal of tropical medicine*, 7, S14-S21.

Bamidele, O., Kolawole, J. T., Ayoka, A. O., Babatunde, L. D., Onaseso, O. O., & Adedeji, G. T. (2017). Wound Healing Potentials of Aqueous Leaf Extract of *Mangifera indica* L. in Wistar Rats. *Journal of Complementary and Alternative Medical Research*, 1-11.

Chah, K. F., Eze, C. A., Emuelosi, C. E., & Esimone, C. O. (2006). Antibacterial and wound healing properties of methanolic extracts of some Nigerian medicinal plants. *Journal of ethnopharmacology*, 104(1-2), 164-167.

Chhetri, H. P., Yogol, N. S., Sherchan, J., Anupa, K. C., Mansoor, S., & Thapa, P. (2010). Formulation and evaluation of antimicrobial herbal ointment. *Kathmandu University Journal of Science, Engineering and Technology*, 6(1), 102-107.

Dunn, L., Prosser, H. C., Tan, J. T., Vanags, L. Z., Ng, M. K., & Bursill, C. A. (2013). Murine model of wound healing. *JoVE (Journal of Visualized Experiments)*, (75), e50265.

Esimone, C. O., Nworu, C. S., & Jackson, C. L. (2008). Cutaneous wound healing activity of a herbal ointment containing the leaf extract of *Jatropha curcas* L.(Euphorbiaceae). *Int J Appl Res Nat Prod*, 1(4), 1-4.

Fayazzadeh, E., Rahimpour, S., Ahmadi, S. M., Farzampour, S., Anvari, M. S., Boroumand, M. A., & Ahmadi, S. H. (2014). Acceleration of skin wound healing with tragacanth (*Astragalus*) preparation: an experimental pilot study in rats. *Acta Medica Iranica*, 3-8.

Gangwar, M., Gautam, M. K., Ghildiyal, S., Nath, G., & Goel, R. K. (2015). *Mallotus philippinensis* Muell. Arg fruit glandular hairs extract promotes wound healing on different wound model in rats. *BMC complementary and alternative medicine*, 15(1), 1-9.

Kumar A, & Singh A. (2012). Review on *Hibiscus rosasinensis*. *International Journal of Research in Pharmaceutical and Biomedical Sciences*, 3(2): 534- 538.

Manzuoerh, R., Farahpour, M. R., Oryan, A., & Sonboli, A. (2019). Effectiveness of topical administration of *Anethum graveolens* essential oil on MRSA-infected wounds. *Biomedicine & Pharmacotherapy*, 109, 1650-1658.

Mudliar, V. S., Patil, P. A., Torgal, S. S., Malur, P. R., & Mittal, R. (2008). Influence of the fruit and leaf extract of *Psidium guajava* Linn. on wound healing in wistar rats. *Journal of Cell and Tissue Research*, 8(1), 1313.

Sawant, S. E., & Tajane, M. D. (2016). Formulation and evaluation of herbal ointment containing Neem and Turmeric extract. *Journal of Scientific and Innovative Research*, 5(4), 149-151.

Sekar, M., & Rashid, N. A. (2016). Formulation, evaluation and antibacterial properties of herbal ointment containing methanolic extract of *Clinacanthus nutans* leaves. *International Journal of Pharmaceutical and Clinical Research*, 8(8), 1170-1174.

Shivananda Nayak, B., Sivachandra Raju, S., Orette, F. A., & Chalapathi Rao, A. V. (2007). Effects of *Hibiscus rosa sinensis* L (Malvaceae) on wound healing activity: a preclinical study in a Sprague Dawley rat. *The international journal of lower extremity wounds*, 6(2), 76-81.

Verma, S., & Singh, S. P. (2008). Current and future status of herbal medicines. *Veterinary world*, 1(11), 347.



3RD DLSU SENIOR HIGH SCHOOL RESEARCH CONGRESS

2023-2024

FOOD, NUTRITION, AND HEALTH

Wang, X., Ge, J., Tredget, E. E., & Wu, Y. (2013). The mouse excisional wound splinting model, including applications for stem cell transplantation. *Nature protocols*, 8(2), 302-309.



Eat, Train, Operate, Repeat: Ang Karanasan ng mga Orthopedic Ironman Triathletes sa kanilang Isport at Propesyon

Monica Isabel Jose and Martha Alyanna Lainey G. Tarrosa
Assumption College San Lorenzo, Makati City

Abstrak: Ang mga Orthopedic Ironman Triathlete ay bihira sa propesyon ng mga doktor. Kadalasan ay malay o mulat sila sa mga maaaring mangyari sa sandaling sumabak sila sa ganitong uri ng isports. Gayunpaman may iilang mga doktor ang naniniwalang may malaking pakinabang ito sa kanilang propesyon. Kaugnay nito nakatuon ang pag-aaral sa pagsusuri sa mga karanasan ng mga Orthopedic Ironman triathlete. Gumamit ang mga mananaliksik ng 15 gabay na tanong na ginamit upang makapanayam ang 13 orthopedic triathletes mula sa iba't ibang ospital sa Pilipinas tungkol sa kanilang mga motibasyon, hamon, at estratehiya. Batay sa isinagawang pagsusuri, natuklasan na ang mga motibasyon nila ay pagbuo ng relasyon sa ibang tao, pagkakaroon ng kredibilidad bilang orthopedic doktor, pagkakaroon ng positibong mental at pisikal na estado/kalusugan, kilalanin ang kakayahan ng sarili, at ang kanilang debosyon sa isport. Habang ang mga hamon na kanilang kinaharap ay ang work-life balance, mental na abala, pisikal na kadahilanan/salik, available resources, panlabas na kadahilanan/sanhi, responsibilidad bilang doktor, at pisikal na abilidad ng katawan pagdating sa pagganap sa isport. Panghuli, ang mga estratehiya na kanilang isinasagawa upang mabalanse ang pagiging doktor at isports ay ang distribusyon ng oras; pisikal, medikal, at kalusugang pangangailangan; pag-unawa at paggamit ng kaalamang pangmedikal at isport; paniniwala, at self-care. Batay sa mga lumabas na pagsusuri, natuklasan na ang mga Orthopedic Triathlete Doctor ay nakaranas ng mga hamon na may kaagapay na benepisyo sa kanilang propesyonal na buhay at kalusugan, bagama't mahirap itong pagsabayin nalagpasan nila ito dahil sa mga estratehiyang kanilang isinagawa.

Susing Salita: doctor-athlete; orthopedic; triathlete; triathlon

1. INTRODUKSIYON

Mahalagang magkaroon ng mabuting kalusugan ang mga doktor upang magampanan nang maayos ang kanilang mga responsibilidad sa kanilang propesyon. Isa sa mga dahilan kung bakit kailangan nila ng mabuting kalusugan ay upang maging handa sa kahit anumang gawain at responsibilidad sa trabaho maging araw man o gabi (Collier, 2012). Ayon sa "Characteristics of highly successful orthopedic surgeons: a survey of orthopedic chairs and editors", upang masabi na ang isang doktor ay matagumpay sa kanilang propesyon, kailangan nilang bigyang atensyon ang kanilang pisikal na kalusugan (Klein, Hussain, Sprague, Mehlman, Dogbey, & Bhandari, 2012). Ang mga doktor na kumakain ng maayos, inaalaan ang kanilang kalusugan, nag-eehersisyo, at hindi gumagamit ng sigarilyo ay masasabing matagumpay sa kanilang propesyon. Ang pagsali rin sa iba't ibang isports sa libreng oras ng mga doktor ay isang paraan upang makatulong sa kanilang pisikal at mental na estado (Khan & Khan, 2016), at para sa ibang doktor ang kanilang sinasalihan na isport ay ang triathlon. Bagama't napag-uusapan ang tungkol sa mga orthopedic triathlete, wala masyadong mga

pag-aaral na tumutukoy sa hamon at estratehiya na kanilang nararanasan. Kung kaya't mahalaga ang pag-aaral na ito dahil ito ay magiging daan para sa mga orthopedic triathlete na maibahagi ang kanilang karanasan sa isport at propesyon. Matutuklasan din sa pag-aaral na ito ang iba't ibang estratehiya na ginagawa ng mga orthopedic triathlete upang harapin ang mga hamong dulot ng kanilang isport at propesyon.

Mga Layunin ng Pag-aaral

Nakatuon ang pananaliksik na ito sa pagsusuri sa karanasan ng mga Pilipinong Orthopedic Triathlete hinggil sa kanilang isport at propesyon.

Nais ng mga mananaliksik na masagot ang mga sumusunod na katanungan:

1. Ano ang motibasyon ng mga orthopedic triathletes sa kanilang isport at propesyon?
2. Ano ang mga hamon na kinakaharap ng mga orthopedic triathletes sa kanilang isport at propesyon?
3. Ano ang mga estratehiya na ginagawa ng mga orthopedic triathletes upang makaya



ang mga hamon ng kanilang isport at propesyon?

Saklaw at Limitasyon

Sakop ng pananaliksik na ito ang pag-aaral sa karanasan ng mga orthopedic triathlete sa Pilipinas. Nakatuon ang pananaliksik na ito sa karanasan ng mga orthopedic triathletes upang matuklasan ang motibasyon, hamon at estratehiya sa kanilang isport at propesyon. Nilimitahan ng mga mananaliksik ang pag-aaral na ito sa mga doktor-triathlete na nakatira sa Pilipinas at lumalahok sa triathlon.

2. METODOLOHIYA

Disenyo ng Pananaliksik

Ang pananaliksik na ito ay gumamit ng penomenolohikal na disenyo ng pag-aaral, sapagkat nakatuon ang papel na ito sa karanasan ng mga orthopedic triathletes. Tinangka nitong ilarawan ang perspektibo ng mga orthopedic triathletes hinggil sa mga hamon, motibasyon at estratehiya na kanilang nararanasan sa isport at propesyon.

Mga Kalahok at Sampling Teknik

Ang mga kalahok ay binubuo ng 13 na pinili mula sa mga orthopedic Ironman triathletes na nagmula sa mga piling ospital sa Pilipinas. Pinili ang mga kalahok gamit ang snowball/referral sampling teknik. Sa pagpili ng mga kalahok sila dapat ay mga orthopedic doktor na may tatlong taon o higit pa na karanasan sa trabaho. Pangalawa, bilang isang triathlete sila dapat ay nakatapos na ng isang Ironman Triathlon. Ito ay upang masukat ang kanilang karanasan sa isport.

Instrumento ng Pag-aaral

Ang instrumento ng pananaliksik na ginamit sa pangangalap ng mga datos ay ang Patnubay na Talatanungan. Naglalaman ito ng mga tanong na nagsilbing gabay sa isinagawang interbyu.

Paraan ng Pagkakatapusan ng mga Datos

Nagsimula sa pagbuo ng patnubay na talatanungan ang mga mananaliksik. Matapos itong maaprobahan at maipa-validate ay humanap ng 13 na mga potensyal na kalahok na siyang kinapanayam.

Pagsusuri ng mga Datos

Mula sa isinagawang pakikipanayam, sinuri ng mga mananaliksik ang mga sagot ng mga respondenteng Orthopedic Ironman Triathlete sa mga tanong tungkol sa mga hamon at motibasyon na kanilang hinaharap at ang mga estratehiya na ginagawa sa kanilang isport at propesyon batay sa

mga nangingibabaw na tema.

3. RESULTA AT DISKUSYON

Batay sa unang tiyak na layunin ang motibasyon ng mga respondente sa kanilang isport at propesyon ay ang pagbuo ng relasyon sa ibang tao. Sila ay nagkakaroon ng mga kaibigan sa labas ng mundo bilang isang doktor dahil sa pagiging triathlete. Isa sa mga halimbawa ng verbatim nito ay “I just know some several friends and several colleagues who were into triathlon so that’s the reason I wanted to do the triathlon.”

Ang sumunod na motibasyon ay ang pagkakaroon ng dagdag na kredibilidad bilang orthopedic doktor. Ito ay sapagkat ang pagiging triathlete ay nagbibigay sa kanila ng pagkakataon upang magkaroon nang mas malalalim na koneksyon sa kanilang mga pasyente. Isa sa mga halimbawa ng verbatim nito ay “It’s important for myself as an orthopedic sports medicine specialist to at least appear or be able to perform athletic endeavors so that I have more credibility with my patients who come to me as injured athletes.”

Ang pagkakaroon naman ng positibong mental at pisikal na estado/kalusugan ay isa rin sa mga motibasyon ng mga kalahok. Bukod pa rito, ang higit na makilala ang kakayahan ng sarili ay isa rin sa kanilang motibasyon. Nagagawa nila ang mga bagay na tulad ng pagsali sa triathlon na akala nila ay hindi nila kayang gawin. Ang panghuli naman ay ang debosyon sa isport sapagkat ang ilan sa mga respondente ay mga atleta mula noong sila ay bata pa. Isa sa mga halimbawa ng verbatim nito ay “We have immediate connection, we can relate immediately, we can talk easily and can voice out their concerns. I would understand cause somehow along the way I probably have experience that type of pain for that kind of problem so we give tips to each other and somehow its very helpful for the patient.”

Ang mga hamon naman na kinahaharap ng mga kalahok ay ang pagkakaroon ng work-life balance. Ang pagiging doktor at triathlete ay parehas na nangangailangan ng maraming oras upang makapag-ensayo at magawa ang responsibilidad sa trabaho. Isa sa mga halimbawa ng verbatim nito ay “Training as a whole takes a lot of time and and medical practice as well”

Dagdag pa rito, ang mga mental na abala (mental distractions) ay isa rin sa hamon na kanilang kinahaharap. Ito ay resulta ng mga mental na salik, kawalan ng motibasyon, at burnout na dulot ng kanilang isport at propesyon. Isa sa mga halimbawang verbatim nito ay “Challenges are: to wake up early the next day after surgery during the wee hours, to smell like chlorine during clinic hours, to sacrifice clinic days for the scheduled triathlon events.”



Ang mga pisikal na kadahilanan/salik naman ay isa ring hamon na kinahaharap ng responente sapagkat ang kanilang mga pisikal na limitasyon, pisikal na katangian, at pisikal na pinsala ay nakaapekto sa kanilang pagganap bilang orthopedic triathlete. Isa sa mga halimbawa ng verbatim nito ay “Ahh relatively I have pains, because of the previous operation and I’m muscular, big, I’m heavy so it adds up impact to my knees as I approach about the 15th or 16th kilometer in doing 70.3.”

Nakikita rin ng mga kalahok bilang hamon ang kakulangan sa kagamitan at pera na nakaapekto sa kanilang pag-eensayo at pagganap sa triathlon. Malaki rin ang salik ng available resources pagdating sa pagpapatuloy ng isport, sapagkat ang kanilang pagganap bilang isang triathlete ay nakadepende rito. Isa sa mga halimbawang verbatim nito ay “The only reason that kept me away from joining triathlon events is money- too expensive.”

Nahaharap din sila sa panlabas na kadahilanan tulad ng edad kung saan nalilimitahan ang pagganap ng isang tao, at ang pagiging delikado ng pag-eensayo at pagsali sa triathlon. Isa sa mga halimbawang verbatim nito ay “triathlon is relatively dangerous sport right. There aren’t where a lot of people die during the race right”

Isa rin sa hamon na kanilang kinahaharap ay ang pagtulong sa pasyente dahil hindi nila maaaring kalimutan ang kanilang mga responsibilidad bilang doktor. Isa sa mga halimbawang verbatim nito ay “personal experience, would be stopping for example during a race because you witnessed someone crash on his bike. Any orthopedic surgeon will be compelled to stop and help the triathlete out.”

Panghuli, ang pisikal na abilidad ng katawan pagdating sa pagganap sa isport ay isa ring hamon sapagkat kulang sila sa karanasan sa isang isport na kasama sa triathlon, o sa antas ng kahirapan ng isport. Isa sa mga halimbawang verbatim nito ay “the race it’s typically middle-aged men noh of which I’m part of that ahh that age group, that population is at risk right”.

Para naman sa mga estratehiyang isinasagawa ng mga orthopedic triathlete upang malampasan ang mga hamon na kanilang kinahaharap ay ang pagkakaroon ng maayos na distribusyon ng oras para sa isport at propesyon. Isa sa mga halimbawang verbatim nito ay “Don’t race against anyone, but rather find your own pace and reach your own goals, and remember to balance triathlon, work, and family.”

Isa rin sa estratehiya na mayroon ang mga responente ay ang pag-unawa at paggamit ng kaalamang pangmedikal at isport para sa mas mahusay na pagganap sa isport at propesyon. Isa sa mga halimbawang verbatim nito ay “Train smart by listening and adhering to my body and I make sure I do my annual cardiac check-ups.”

Ang susunod na estratehiya naman ay ang pagkakaroon ng paniniwala sa Diyos at sa sarili. Ito ay nakatutulong upang magawa nila ang mga bagay na higit pa sa akala nilang kaya nilang gawin. Isa sa mga halimbawang verbatim nito ay “Triathletes can avoid injuries thru proper training/gears, diet, hydration, and 8 hours of sleep, listen to your body, and PRAY, always Pray to God”.

Ang panghuling estratehiya naman ay ang pangangalaga sa sarili sa pamamagitan ng pagbibigay ng premyo sa kanilang mga sarili. Isa sa mga halimbawang verbatim nito ay “one simple mechanism that I apply to myself would be the reward system.”

Diskusyon

Batay sa inilahad na resulta, isa sa motibasyon ng mga orthopedic triathlete ay ang pagbuo ng relasyon. Sumang-ayon dito ang pag-aaral nina Soklaridis et al. (2016), kung saan inilahad na importante na magkaroon ng relasyon/koneksyon ang mga doktor sa kanilang pasyente sapagkat batay sa relationship-centered care (RCC) framework may relasyon ang koneksyon ng mga pasyente at doktor sa kinalalabasan ng paggamot sa kanila. Samantala, ang tema naman na pagkakaroon ng kredibilidad bilang orthopedic doktor ay isang motibasyon din ng mga orthopedic triathlete. Sumang-ayon naman dito sina Gopichandran at Chetlapalli (2015), ayon sa kanilang pag-aaral, mas malaki ang pagkakataon na pagkatiwalaan ng mga pasyente ang kanilang doktor kapag nakikita nila na alam nila ang kanilang ginagawa. Isa ring tema na lumabas ay ang positibong mental at pisikal na estado/kalusugan. Marami sa mga doktor ay nakararanas ng burnout at stress na dulot ng kanilang propesyon (Feeney et al., 2016). Samantala ang pagsali sa mga isport na tulad ng triathlon ay isang epektibong coping mechanism upang makalimutan ang mga problemang kinahaharap sa trabaho. Sinang-ayunan ito ng pag-aaral nina Khan at Khan (2016) kung saan inilahad na isang halimbawa ng positibong coping mechanism ng mga doktor ay ang pagiging pisikal na aktibo. Ang tema rin na pagkakataon upang higit na kilalanin ang kakayahan ng sarili ay lumabas sapagkat ayon sa mga responente hindi nila inaakala na magagawa nila ang pagsali sa mga paligsahang pan-triathlon. Ito ay sinang-ayunan ng isang doktor-triathlete na si Dr. Gossage na nagsabi na ang triathlon ay naging isang paraan upang mas makilala niya ang kaniyang sarili (O’ Dowd, 2020). Ang panghuling tema naman ay ang debosyon sa isport. Masasabi na ito ay katulad ng karanasan ng isang doktor triathlete, na nagsabi na siya ay isang batang atleta, at ito ang nakaenganyo sa kaniya na maging triathlete noong siya ay tumanda na at naging doktor (Carter, 2016).



Ipinakita naman sa resulta na isa sa mga hamon na kinaharap ng mga orthopedic triathlete na kalahok ay ang kawalan ng work-life balance at hindi maganda ang nagiging epekto nito sa propesyonal na pagganap ng mga doktor. Apektado rito ang mga kababaihan, dahil ang mga babae ay likas na maaruga at ito ay isa sa pinakaimportanteng ugali ng isang doktor, ngunit dahil sa pagkawala ng work-life balance ito ay maaaring mawala sa kanila (Rich et al., 2016). Nagiging hamon din ang pisikal na kadahilanan kung saan ang kanilang pisikal na katangian at mga pinsala ay nakaaapekto sa kanilang pagganap sa ekstensibong pagsasanay at mga triathlon na kanilang sinasalihan. Kung ang isang atleta ay nagkaroon ng pinsala sa nakaraan at hindi malakas ang pangangatawan, posible silang makaranas ng mas malala na pinsala at sakit (Vleck et al., 2014). Ayon naman sa pag-aaral nina Prinz et al., (2013) ang triathlon ay naging isang mamahaling isport dahil sa lumalaking bilang ng mga taong sumasali rito. Sinasang-ayunan nito ang lumabas na tema hinggil dito. Ang iba't ibang panganib naman na maaaring maganap sa panahon ng triathlon at pag-eensayo ay kadalasang walang malinaw na ebidensya at hindi nasusukat sa antas ng karanasan (Ashkar & Romani, 2014) at ito rin ay isa sa mga nagiging hamon sa kanila. Nakikita rin bilang isang hamon ang hindi maaaring kalimutan ang responsibilidad bilang doktor. Ang mga doktor ay may responsibilidad na gampanan ang iba't ibang pangangailangan ng kanyang pasyente at ang paglabag sa alinman sa mga tungkulin na ito ay kapabayaan sa bahagi ng doktor (Pandit & Pandit, 2009). Ang huling tema na lumabas ay ang pisikal na abilidad ng katawan pagdating sa pagganap sa isport. Ayon sa ilang kalahok nahihirapan sila sa ibang mga isport na kasama sa triathlon at dahil rito hindi nila naibibigay ang kanilang buong kakayahan. Ayon sa pag-aaral na ginawa nina Stevenson, Song, at Cooper (2013) ang pagbaba ng antas ng pagganap ng isang triathlete ay maiuugnay sa kanilang edad sapagkat ang edad 30-35 ay kung kailangan na naaabot ng atleta ang tugatog ng kaniyang pagganap.

Ayon sa pag-aaral nina Macquet at Skalej (2015), ang mga atleta ay gumagamit ng iba't ibang klase ng estratehiya tulad ng time management. Ito ay sumang-ayon sa lumabas na tema sa estratehiya ng distribusyon sa oras. Ang pisikal, medikal at kalusugang pangangailangan ay isa rin sa mga estratehiya na ginagawa ng mga respondente kung saan kanilang pinakikinggan o pinakikiramdaman ang pangangailangan ng katawan (Etxebarria et al., 2019). Nakikita rin ng mga respondente bilang isang estratehiya ang pagkakaroon ng paniniwala sa sariling kakayahan at pagtitiwala sa Diyos. Sumasang-ayon ang mga resulta sa ilang pag-aaral, kung saan ang mga tao na may inspirasyon ay

kadalasang may malakas na pananampalataya sa Diyos dahil ito ay nagbibigay ng isang koneksyon na higit pa sa kanilang sarili (Cricher & Lee, 2018). Panghuli, ayon sa isang pag-aaral nina Harwood et al., (2014), ang intrinsic motivation ay ang paggawa ng isang bagay sapagkat ito ay nakagaganyak sa sarili, isa ito sa motivational influences na estratehiya na ginagawa ng mga tagapagsanay at mga atleta na nagpapabuti sa kanilang mga gawain.

4. KONKLUSYON

Sa kabuoan ang karanasan ng mga Orthopedic Triathlete sa pagiging doktor at atleta ay hindi palaging maganda dahil sa iba't ibang hamon na kanilang nararanasan. Ngunit, mas nangingibabaw pa rin ang naging benepisyo nito para sa kanilang propesyonal na buhay at kalusugan sa tulong na rin ng mga estratehiyang kanilang isinagawa. Samakatuwid, nakatutulong ang kanilang propesyon bilang doktor sa kanilang pagiging triathlete at gayundin naman ang triathlon sa kanilang pagiging isang epektibong Orthopedic doktor.

5. PASASALAMAT

Taus-pusong pasasalamat ang aming ipinaabot sa mga sumusunod na indibidwal at tanggapan dahil sa mahahalagang tulong, kontribusyon at/o suporta tungo sa matagumpay na reyalisasyon ng pananaliksik na papel na ito:

Sa mga Orthopedic Triathletes na nakilahok sa pakikipanayam na naglaan ng panahon at sumagot nang matapat sa aming inihandang talatanungan. Kay Dra. Jose na nagsilbing inspirasyon at tulay upang makahanap ng mga respondente, at sa paggabay sa mga mananaliksik sa pag-intindi sa mga termino ng medisina,

Sa mga awtor, editor at mga mananaliksik ng mga akdang pinaghanguan namin ng mahahalagang impormasyong aming ginagamit sa pagsulat ng una at ika-apat na kabanata ng pananaliksik na papel, Kina Bb. Anna Patricia V. Gerong at Bb. Abbygale C. Pinca, mga masisigasig naming dalubguro na gumabay sa amin sa tamang hakbangin sa pagsulat at paggawa ng isang pananaliksik na papel,

Sa aming mga magulang at pamilya, sa pag-unawa, paghintulot at pagsuporta sa buong proseso ng paggawa ng mga mananaliksik sa pananaliksik na papel,

Sa 11-S2, sa pagbibigay saya, sigla, at pag-asa tuwing nahihirapan na kami sa pagsulat ng aming papel, at sa pagbibigay aruga kapag kami ay umiiyak na, at higit sa lahat,

Sa Poong Maykapal, sa pagdinig sa aming mga dalangin lalung-lalo na sa sandaling kami ay pinanghihinaan na ng pag-asang matapos naming ito nang maayos sa itinakdang-panahon.



Muli ay maraming Salamat po! Mga Mananaliksik

https://www.researchgate.net/publication/237154749_Distractions_and_Their_Impact_on_Patient_Safety

6. MGA SANGGUNIAN

- Andersen, C., Clarsen, B., Engebretsen, L. & Johansen, T. (2013). High prevalence of overuse injury among iron-distance triathletes. *Br J Sports Med* 2013, 47(13), p. 857–861. doi:10.1136/bjsports-2013-092397
- Braun, S. (2015). Determinants of stress and effects on performance in internal medicine residents (Master's Thesis). Mula sa <http://scholarscompass.vcu.edu/etd/3799>
- Carter, S. (2016). The sporty doctor. Mula sa <https://www.bmj.com/content/354/sbmj.i1715.full>
- Charlton, R. (w.p.). Top tips: difficult decisions – doctors as patients. Mula sa <https://journals.sagepub.com/pb-assets/cmscontent/INO/Charlton%20-%20Doctors%20as%20patients%20FINAL-1502289426580.pdf>
- Critchler, C., & Lee, C. (2018). Feeling Is Believing: Inspiration Encourages Belief in God. *Psychological Science*, 29(5), p. 723–737. doi:10.1177/0956797617743017
- Collier, R. (2012). Healthier doctors, healthier patients. 184(17), p. E895-E896. doi:10.1503/cmaj.109-4327
- Eime, R., Young, J., Harvey, J., Charity, M., & Payne, W. (2013). A systematic review of the psychological and social benefits of participation in sport for adults: informing development of a conceptual model of health through sport. *International Journal of Behavioral Nutrition and Physical Activity*, 10, p. 1-14. doi:10.1186/1479-5868-10-135
- Etzebarria, N., Mujika, I., & Pyne, D. (2019). Training and competition readiness in triathlon. *Sports*, 7(5), p. 1-15. <https://doi.org/10.3390/sports7050101>
- Feeney, S., et. al. (2016). Practise what you preach: health behaviours and stress among non-consultant hospital doctors. *Clinical Medicine Journal*, 16(1), p. 12-18. doi:10.7861/clinmedicine.16-1-12
- Feil, M. (2013). Distractions and their impact on patient safety. *Pennsylvania Patient Safety Authority*, 10(1), p. 1-12. Mula sa https://www.researchgate.net/publication/237154749_Distractions_and_Their_Impact_on_Patient_Safety
- Field, A., Kocher, M., Tepolt, F., Yang, D., & Mininder, K. (2014). Injury risk associated with sports specialization and activity volume in youth. *The Orthopaedic Journal of Sports Medicine*, p. 1-6. doi:10.1177/2325967119870124
- Gopichandran, V., & Chetlapalli, S. (2015). Trust in the physician–patient relationship in developing healthcare settings: a quantitative exploration. *Indian Journal of Medical Ethics*, 12(3), p. 141-148. doi:10.20529/IJME.2015.043
- Harwood, C., Lavalley, D., Keegan, R., & Spray, C. (2014). A qualitative investigation of the motivational climate in elite sport. *Psychology of Sport and Exercise*, 15(1), p. 97–107. doi:10.1016/j.psychsport.2013.10.006
- Khan, S. & Khan, A. (2016). Effectiveness of recreational activities among the doctors community of district dera. *Noble International Journal of Social Sciences Research*, 1(1), p. 16-20. Mula sa <https://napublisher.org/pdf-files/NIJSSR-206-16-20.pdf>
- Klein, G., Hussain, N., Sprague, S., Mehlman, C., Dogbey, G., & Bhandari, M. (2012). Characteristics of highly successful orthopedic surgeons: a survey of orthopedic chairs and editors. *Canadian Journal of Surgery*, 56(3), p. 192-198. doi:10.1503/cjs.017511
- Kruger, M., Myburgh, E., & Saayman M. (2014). A motivation-based typology of triathletes. *South African Journal for Research in Sport, Physical Education and Recreation*, 36(3), p. 117-134. Mula sa <https://www.ingentaconnect.com/content/sabinet/sport/2014/00000036/00000003/art00010>
- Lepers, R., Knechtle, B., & Stapley, P. (2013). Trends in triathlon performance: effects of sex and age. *Sports Medicine*, 43(9), p. 851–863. doi:10.1007/s40279-013-0067-4
- Lundman, B., Aléx, L., Jonsén, E., Norberg, A., Nygren, B., Fischer, R., & Strandberg, G. (2009). Inner strength—a theoretical analysis of salutogenic concepts. *International Journal of Nursing Studies*, 47(2), p. 251–260. doi:10.1016/j.ijnurstu.2009.05.020



- Macquet, A. C. & Skalej, V. (2015). Time management in elite sports: How do elite athletes manage time under fatigue and stress conditions?. *Journal of Occupational and Organizational Psychology*, 88(2), p. 341-363. doi: 88. 10.1111/joop.12105.
- Medical College of Wisconsin. (2018). On the other side of the stethoscope: when doctors become patients. Mula sa <https://www.mcw.edu/mcwknowledge/mcw-stories/on-the-other-side-of-the-stethoscope-when-doctors-become-patients>
- Ocampo, J. (2010). Personal motivation of physicians: A study focused on motivations by job enrichment and job satisfaction of public sector physicians in Ecuador (Doctoral Dissertation). Mula sa ProQuest Dissertations Publishing (3423955)
- O' Dowd, A.(2020). Why I . . . do triathlons. doi: 10.1136/bmj.l6891
- Pandit, M. S., & Pandit, S. (2009). Medical negligence: Coverage of the profession, duties, ethics, case law, and enlightened defense - A legal perspective. *Indian journal of urology : IJU :Journal of the Urological Society of India*, 25(3), p. 372–378. doi: 10.4103/0970-1591.56206
- Parry, D., Chinnasamy, C., Papadopoulou, E., Noakes, T., & Micklewright, D. (2010). Cognition and performance: anxiety, mood and perceived exertion among Ironman triathletes. *British Journal of Sports Medicine*, 45(14), p. 1088–1094. doi:10.1136/bjism.2010.072637
- Prinz, J., Wicker, P., & Weimar, D. (2013). Big spenders in a booming sport: Consumption capital as a key driver of triathletes' sport-related expenditure. *Managing Leisure*, 18(4), p. 286-299. doi: 18. 10.1080/13606719.2013.809190.
- Rich, A., Viney, R., Needleman, S., Griffin, A., & Woolf, K. (2016). 'You can't be a person and a doctor': the work-life balance of doctors in training—a qualitative study. *BMJ Open*, 6, p. 1-9. doi:10.1136/bmjopen-2016-013897
- Robert Wood Johnson Foundation. (2015). Sports and health in America. Mula sa <https://media.npr.org/documents/2015/june/sport-sandhealthpoll.pdf>
- Romani, M., & Ashkar, K. (2014). Burnout among physicians. *Libyan Journal of Medicine*, 9(1), p. 23556. doi:10.3402/ljm.v9.23556
- Schorn, D., et. al. (2018). Risk factors for acute injuries and overuse syndromes of the shoulder in amateur triathletes - a retrospective analysis. *PLOS one*, 13(6), p. 1-9. doi: 10.1371/journal.pone.0198168
- Soklaridis, S., Ravitz, P., Nevo, G., & Lief, S. (2016). Relationship-centred care in health: A 20-year scoping review. *Patient Experience Journal*, 3(1), p. 130-145. doi: 10.35680/2372-0247.1111
- Stanciu, C., Gnanasegaram, S., Brooks, N., Ahmed, S., Kohrman, S., & Teja, N. (2018). Physician wellness and substance use—a brief review. *Journal of Alcoholism & Drug Dependence*, 6(3), p. 1-3. doi:10.4172/2329-6488.1000e142
- Stevenson, J., Song, H., & Cooper, J. (2013). Age and sex differences pertaining to modes of locomotion in triathlon. *Medicine & Science in Sports & Exercise*, 45(5), p. 976–984. doi:10.1249/mss.0b013e31827d17eb
- Stults-Kolehmainen, M., & Sinha, R. (2013). The effects of stress on physical activity and exercise. *Sports Medicine*, 44, p. 81-121. doi: 10.1007/s40279-013-0090-5
- Steifel, M., Rust, C., Rosemann, T., Knechtle, B. (2013). A comparison of participation and performance in age-group finishers competing in and qualifying for Ironman Hawaii. *Int J Gen Med*, 6, p. 67-77. doi: 10.2147/IJGM.S40202
- van den Hombergh, P., Künzi, B., Elwyn, G., van Doremalen, J., Akkermans, R., Grol, R., & Wensing, M. (2009). High workload and job stress are associated with lower practice performance in general practice: an observational study in 239 general practices in the Netherlands. *BMC Health Services Research*, 9(118), p. 1-8. doi:10.1186/1472-6963-9-118
- van der Burgt, S., Kusurkar, R., Croiset, G., Peerdeman, S. (2018). Exploring the situational motivation of medical specialists: a qualitative study. 9, p. 57-63. doi: 10.5116/ijme.5a83.6025
- Vleck, V., Millet, G. & Alves, F. (2014). The impact of triathlon training and racing on athletes' general health. *Sports medicine*, 44, p. 1659-1692. doi: 10.1007/s40279-014-0244-0



Ang mga Coping Mechanisms at Motibasyon ng mga Medikal na Frontliners hinggil sa Stress at Burnout sa Panahon ng Pandemya 2021

Anne Mairead P. Castaneda, and Mary Kamillah R. Reyes
Assumption College, San Lorenzo, Makati

Abstract: Taong 2020 nang simulang mapabalita ang nakahahawang sakit na Covid-19, nang dahil dito maraming ospital ang unti-unting napuno ng mga pasyente at isa sa mga matatapang at magiging na frontliners na humaharap at patuloy na lumalaban dito ay ang mga doktor. Kaugnay nito nakatuon ang pag-aaral na ito sa mga karanasan ng mga medikal frontliners partikular na ang mga doktor sa kanilang coping mechanisms at motibasyon sa pagharap sa stress at burnout. Gumamit ang mga mananaliksik ng 13 Patnubay na talatanungan na ginamit sa 15 kalahok na pinili gamit ang purposive sampling teknik. Batay sa isinagawang pagsusuri natuklasan ng mga mananaliksik na ang mga dahilan ng kanilang stress at burnout ay ang mabibigat na kondisyon sa trabaho, exposure sa Covid-19, seguridad ng trabaho, at problema sa kalusugang mental. Samantala ang kanilang mga coping mechanisms ay pagkain, komunikasyon sa pamilya at kaibigan, self-care, emotional release, entertainment, at ispiritwal. Panghuli ang pangako sa tungkulin, pamilya, at pasyente ang nagsisilbing motibasyon nila. Sa kabuoan hindi naging madali ang pagiging medikal frontliner lalo na sa panahon ng pandemya. Bagama't ganito ang sitwasyon hindi pa rin tumitigil ang mga doktor dahil pinanghahawakan nila ang kanilang sinumpaang tungkulin.

Key Words: stress; burnout; motibasyon; coping; mechanisms

1. INTRODUKSYON

Noong Marso 15, 2020, ipinatupad ng gobyerno ng Metro Manila at ng iba pang apektadong rehiyon ang ilang mga gabay para sa *community quarantine* sa pag-asang masugpo ang paglaganap ng COVID-19 (Talabong, 2020). Ngunit sa kabila nito, marami pa rin ang nahahawa at nagkakasakit. Ayon sa *Department of Health*, ang bansa ay muling nakapagtala noong Enero 11, 2021 ng higit sa dalawang libong panibagong kaso (Magsambol, 2021). Nangangahulugan na patuloy pa rin ang trabaho at sakripisyo ng sektor para sa *healthcare*. Bagama't lubhang napakahalaga ang gawain ng mga medikal na *frontliners* sa pag-aalaga ng mga nahawa at sa pagpapatigil sa mga epekto ng COVID-19, makikita na hindi kasiya-siya ang sitwasyon nila. Nariyan ang kakulangan sa mga ospital at pasilidad, ang kakulangan sa mga kagamitan para sa kanilang proteksyon, ang halos walang patid na pagtatrabaho dahil na rin sa kakulangan ng mga medikal na tauhan at empleyado, ang patuloy na pagsuway ng mga tao sa mga itinakdang mga protokol, at ang patuloy na pagdagsa ng mga pasyente. Dahil dito, maraming mga medikal na *frontliners* ang nakakaranas ng *stress* at *burnout*. Ayon kay Zhang at iba pa (2020), sa Hong Kong, 92.3% sa mga nars na sumagot sa sarbey nito ay nakaranas ng *burnout* dahil sa kanilang trabaho dahil hindi nila makapiling ang kanilang mga

pamilya sa matagal na panahon. Ang mga respondenteng may mas matagal na oras ng pagtatrabaho at ang mga mas batang respondente ay nagpapakita ng mas matinding sintomas ng *stress* at *burnout*. Batay naman sa isang pag-aaral na nanggaling sa Portugal, ang pagdaragdag ng trabaho ng mga *frontliner* sa mga ospital, gayundin ang patuloy na pagkakalantad nila sa nakababahalang mga sitwasyon, ay mayroong kaugnayan sa kanilang mga karanasan tungo sa *stress* at *burnout* (Duarte atbp., 2020). Bilang mga medikal na *frontliners*, ang pisikal na kalusugan ay kinakailangan para sa episyenteng pangangalaga sa mga pasyente. Ipinakikita sa isang pag-aaral na maliban sa sikolohikal na epekto, mayroon ding masamang naidudulot ito sa pisikal na kalusugan ng mga tao.

Mula sa mga dahilang nabanggit, layunin ng pag-aaral na ito na malaman at masuri ang mga karanasan ng mga medikal na *frontliners* sa panahon ng pandemya. Sa mas espesipikong pagtingin, bibigyang pansin ang mga dahilan na nagdudulot ng *stress* at *burnout*, ang *coping mechanisms* nila sa pagharap sa mga ito at ang kanilang motibasyon sa kabila ng mga hamong kanilang nararanasan. Ang kapakinabangan ng mga resulta sa isasagawang pag-aaral na ito ay ang maaaring tulong na maidudulot nito sa mga taong nalalagay sa parehong sitwasyon



kung saan madaling makaranas ng *stress at burnout* ngayong panahon ng pandemya.

1.2 Mga Layunin ng Pag-aaral

Nakatuon ang pag-aaral na ito na malaman at masuri ang iba't ibang karanasan ng mga medikal na *frontliners* sa panahon ng pandemya.

Nais ng mga mananaliksik na masagot ang mga sumusunod na katanungan:

1. Anu-ano ang mga **dahilan** ng *stress at burnout* sa trabaho ng mga medikal na *frontliners*?
2. Anu-ano ang ***coping mechanisms*** na ginagawa ng mga medikal na *frontliners* sa pagharap sa *stress at burnout*?
3. Anu-ano ang mga **motibasyon** ng mga medikal na *frontliners* sa kabila ng mga hamong nararanasan nila ngayong panahon ng pandemya?

1.3 Saklaw at Limitasyon

Sakop ng pananaliksik na ito ang pagsusuri sa karanasan ng mga medikal na *frontliners* na nagtrabaho sa Metro Manila sa taong 2021 hinggil sa kanilang *coping mechanisms* at motibasyon sa *stress at burnout*. Ang pag-aaral na ito rin ay limitado sa mga nars at mga doktor na nagtatrabaho bilang medikal na *frontliners* sa kasalukuyang panahon ng pandemya sa mga ospital (pribado o pampubliko) sa Metro Manila.

Sa pag-aaral na ito, hindi kabilang ang mga doktor at nars na hindi nagtatrabaho sa mga ospital, ospital sa rural, mga medikal na *frontliners* na nagtatrabaho sa ibang rehiyon, ang mga OFW (Overseas Filipino Workers) na medikal na *frontliner*, at ang mga doktor na hindi pa nakapagtapos ng kanilang *residency*.

2. METODOLOHIYA

2.1 Disenyo ng Pananaliksik

Ang pag-aaral na ito ay tungkol sa mga karanasan ng mga medikal na *frontliners* sa Metro Manila. Binigyang pansin ang kanilang *coping mechanisms* hinggil sa *stress at burnout*, at ang kanilang mga motibasyon upang ipagpatuloy ang kanilang mga tungkulin. Ito ay isinagawa gamit ang penomenohikal na disenyo. Tinangka nitong suriin sa konteksto ang saloobin ng mga medikal na *frontliners*.

2.2 Mga Kalahok at Sampling Teknik

Ang mga kalahok ay binubuo ng 13 medikal na *frontliners* mula sa iba't ibang ospital o klinik sa Metro Manila. Pinili ang mga kalahok gamit ang teknik na *SnowBall Sampling* kung saan ilang *point persons* ang nagsilbing tagapag-ugnay sa mga napiling tutugon sa pananaliksik. Ang isa pang sampling teknik na ginamit ay *Purposive Sampling*, dahil may batayan na dapat hanapin sa bawat kalahok. Katulad na lamang ng pagiging doktor at pagseserbisyo sa panahon ng pandemya.

2.3 Instrumento ng Pag-aaral

Ang instrumento ng pananaliksik na ginamit sa pangangalap ng mga datos ay ang Patnubay na Talatanungan. Naglalaman ito ng 13 mga tanong na nagsilbing gabay sa isinagawang interbyu.

2.4 Paraan ng Pagkakalap ng mga Datos

Nagsimula sa pagbuo ng patnubay na talatanungan ang mga mananaliksik. Matapos itong maaprobahan at maipa-validate ay humanap ng mga potensyal na kalahok na siyang kinapanayam.

2.5 Pagsusuri ng mga Datos

Mula sa isinagawang pakikipanayam, sinuri ng mananaliksik ang mga sagot ng mga kalahok na medikal na *frontliners* sa Metro Manila batay sa mga nangingibabaw na tema. Sinuri din ang mga dahilan sa mga karanasan hinggil sa *stress at burnout*, *coping mechanisms* at motibasyon ng mga medikal na *frontliners*.

3. RESULTA AT DISKUSYON

Batay sa isinagawang pagsusuri makikita na isa sa mga dahilan ng *stress at burnout* sa mga kalahok ay ang mahirap o mabigat na kondisyon sa trabaho. Isa na rito ay ang paggamit ng PPE sa trabaho sapagkat mainit at hindi komportable ang pagsuot nito. Dahil mahaba ang kanilang araw bilang medikal na *frontliner*, nakakapagod ito. Narito ang isa sa mga halimbawang verbatim "*Especially the respirator, when you have been wearing it for quite some time. It's draining already. And it's also hot. Aside from that it is quite tedious not to see things clearly because you have to wear goggles.*"

Bukod pa rito, dahil sa pandemya, ang bilang ng mga pasyente sa E.R. at sa buong ospital ay biglang dumami. Dagdag pa sa kahirapan ng mga kondisyon sa ospital dahil may kakulangan ang bilang ng mga *frontliners* at ang mga PPE na kailangan nilang gamitin. Ayon kay Hanna at Mona (2014) tulad



sa nabanggit sa Fried at Fisher (2016), sa iba't ibang institusyon, katulad ng ospital, ang stress at burnout ay maaaring magmula sa mga mahirap na kondisyon at sitwasyon hinggil sa trabaho, ang mga problema sa pamilya o ang mga katrabaho, at ang kondisyon ng paligid nila, katulad ng kakulangan ng suporta at sobrang *pressure* galing sa mga kailangan nilang makamit. Isa pang dahilan ng *stress at burnout* ay ang malaking posibilidad ng *exposure* sa COVID-19, lalo na bilang medikal na *frontliner* na laging kailangang nakaharap sa mga pasyente sa mga ospital at klinika. Sinag-ayunan ito ng isang pag-aaral nina Mahmood at iba pa (2020), na ang malaking posibilidad na mahawa ang mga medikal na frontliners at ang kanilang pamilya, ay nagreresulta sa high anxiety sa trabaho. Narito ang isa sa mga halimbawang verbatim *“Everytime you hear the anxiety it’s because you have to trace everyone whom you contacted with. If ever I got infected, I have to contact whom I infected with. That is the most stressful part of me as a doctor.”*

Isa pang dahilan ng *stress at burnout* ay ang mga problema ng mga pasyente. Batay sa mga sagot ng mga respondente, ang mga problema ng mga pasyente ay nagpapaalala sa kanilang kondisyon dahil sa emosyonal na epekto ng pandemya at ang *stigma* patungo sa mga pasyente na nagreresultang positibo para sa COVID-19. Kaugnay dito, minsan mayroong mga pagkakataon na namamatay ang mga pasyente. Samakatuwid, ang mga problema ng mga pasyente ay maaaring maging problema ng mga doktor at nars sapagkat ang mga pasyente nila ay ang kanilang responsibilidad. Karagdagan dito, ang pag-aalala sa seguridad ng kanilang trabaho ay isa sa mga dahilan ng *stress at burnout* ng mga medikal na *frontliners*. Mga bagong protokol ng COVID, at pagpapatupad ng quarantine sa simula ng pandemya, marami sa mga *frontliners* ang hindi nakakapasok sa kanilang mga trabaho sa ospital o klinika. Dahil dito, nagkaroon ang ilang mga *frontliners* ng takot sapagkat hindi sigurado ang pagtanggap ng kanilang sweldo para sa pang araw-araw na gastusin. Ang huling dahilan ng *stress at burnout* ay ang mga negatibong epekto ng pandemya sa mental na kalusugan ng mga tao. Ito ang nagiging dahilan ng *anxiety* at kalungkutan. Ang mga kondisyon at pang araw-araw na ganitong karanasan ang nagbibigay daan sa *stress* o *burnout* sa mga medikal na frontliners. Narito ang isa sa mga halimbawang verbatim *“Now na may work na kami, malaki ang... nawala sa income, kasi sa income ko, personally, I lost more than half of my income because I don’t do surgeries nowadays kasi nga I’m-I’m wary of the...”*

Batay naman sa naging resulta hinggil sa coping mechanisms sa *stress at burnout* ng mga kalahok, isa sa mga isinasagawa nila ay ang pagkain. Ginagawang *stress relief* ito ng mga kalahok

matapos ang mahirap at nakakapagod na araw sa trabaho. Narito ang isa sa mga naging verbatim *“Yes, non-negotiable talaga yun. Naku fatty foods hehe, carbs. At coffee, puro coffee. But I really make sure that I hydrate talaga, non-negotiable din yan. Coffee, hydrate, maraming kinakain na Carbs and sweets.”*

Isa ring *coping mechanism* na ginagawa ng mga respondente ay ang pakikipag-usap sa mga katrabaho, pamilya o sa mga taong malapit sa kanilang buhay. Sapagkat napapagaan nito ang kanilang loob at ito ay isang pagkakataon para ipahayag ang kanilang nararamdaman sa ibang tao. Bukod pa rito ayon kay Kaiser (2018), ang komunikasyon ay nakatutulong din sa pagbaba ng antas ng *stress*, lalo na sa kapaligiran ng trabaho. Isa pang *coping mechanism* na ginagawa nila sa sitwasyon ng *stress at burnout* ay ang paglabas ng mga emosyon nila sa pamamagitan ng pag-iyak at *journaling*. Ang pag-iyak ay isang paraan para makakuha ng kalakasan para sa sarili at para sa mga hamon na kailangan nilang harapin. Karagdagan dito, ang *journaling* din ay isang paraan para ilabas ang mga bagay na kinatatakutan nila. Ang pag-iyak ayon kay Gracanin, at iba pa (2014), ay isang paraan para alisin ang tensyon sa katawan, kaya ito ay ginagawa ng mga tao kapag sila ay nagiging emosyonal. Ang *journaling* naman, ayon kay Johnson (2019), ay isang paraan para ilabas ang mga matinding emosyon pagkatapos ng isang *stressful* na karanasan.

Isa pang *coping mechanism* na ginagawa nila ay sa pamamagitan ng ehersisyo, meditasyon at kalinisan o *hygiene*. Ang mga gawain na ito ay nakatutulong sa paglabas ng mga negatibong pag-iisip at enerhiya. Bukod pa rito, ayon kay Mellis (2018), ang *self-care* ay mahalaga dahil ito ay nagbibigay ng positibong emosyon habang nagtatrabaho ang isang tao, ito rin ay nakakabawas ng antas ng *stress* sa kapaligiran ng trabaho. Ang mga gawaing masaya katulad ng panonood ng mga Koreanong teleserye o K-drama, Netflix at paglalaro ng *computer/mobile games* ay isa pang *coping mechanism*. Ito ang nagiging isang paraan para makaisip sila ng iba pang bagay maliban sa trabaho lamang. Ito rin ay isang paraan upang mapasaya ang sarili kahit sobrang matindi ang mga ginagawa nila sa trabaho. Sa huli, isa pang *coping mechanism* na ginagawa ng mga medikal na *frontliners* ay ang pagdarasal dahil ito ay isang paraan upang makondisyon ang sarili para sa mga hamon na kailangan nilang harapin sa trabaho, kahit ito ay mahirap at nakakapagod. Narito ang isa sa mga halimbawang verbatim *“I feel like praying really helped me. The fact that I can’t mentally even just for myself kind of unburden or talk to somebody without judgement.”*



Samantala ang mga naging motibasyon naman ng mga medikal na *frontliners* ay ang mga pangako at tungkulin sa kanilang trabaho, ang kanilang mga pamilya at mahal sa buhay, at ang kanilang mga pasyente. Ang unang motibasyon ng mga kalahok ay ang pangako at tungkulin nila bilang mga medikal na *frontliner*. Ito ay binubuo ng kanilang pagmamahal para sa kanilang trabaho, ang mga responsibilidad sa trabaho nila, at ang pagnanais na makatulong sa ibang tao katulad ng mga pasyente nila. Narito ang isa sa mga halimbawang verbatim “*We have that hippocratic oath that do no harm, do good and try to help everybody. So I guess that’s it... So even if there’s no pay...*”

Kaugnay nito, nagiging motibasyon din ang mga responsibilidad nila sa kanilang mga pasyente sa paggawa ng kanilang tungkulin. Batay sa mga datos, maraming mga kalahok ang nagsisilbing guro at tagagabay para sa mga nagnanais na maging medikal na *frontliner* sa kabila ng pandemya. Ang responsibilidad sa mga estudyante ay naging isang motibasyon para sa mga naging kalahok. Ang isa pang motibasyon ng mga medikal na *frontliners* ay ang kanilang tungkulin para sa kanilang pamilya at mahal sa buhay. Ayon sa mga datos, isa sa mga responsibilidad ng mga medikal na *frontliners* sa kanilang mga pamilya ay ang pagsisigurado na ang kanilang mga pamilya ay hindi mahihirapan sa panahon ng pandemya. Sinusuportahan ito ng isang pag-aaral nina Ratanawongsa at iba pa (2006), na ang dahilan kung bakit tumutuloy ang mga doktor sa kanilang trabaho, ay dahil sa pagnanais na tumulong sa ibang tao, pamilya, at ang kanilang komunidad. Ang huling motibasyon ng mga medikal na *frontliners* ay ang kanilang mga pasyente. Sapagkat ang mga pasyente na muling bumabalik sa mga klinika o ospital ay isang bagay na nag-uudyok sa mga medikal na *frontliners* na tumuloy magtrabaho kahit may posibilidad ng *exposure* sa COVID-19. Bukod pa rito, ang mga pasyente na gumaling mula sa kanilang mga sakit ay nagsisilbing inspirasyon at motibasyon sa mga medikal na *frontliners*, lalo na sa mga mahihirap na sitwasyon. Ang paggaling ng mga pasyente ay nagbibigay ng pag-asa sa kanila sa kabila ng *stress* at *burnout* na nararanasan nila sa kanilang mga trabaho ngayong panahon ng pandemya. Sinagayunan ito ng isang pag-aaral nina Deng, at iba pa (2018), na ang magandang relasyon ng isang doktor sa pasyente, ay nagiging dahilan kung bakit tumataas ang *work satisfaction* nila, at nagiging dahilan din kung bakit tumutuloy sila sa kanilang trabaho. Narito ang isa sa mga halimbawang verbatim “*A lot of people usually say the money... but at the end of the day with things that you do, it is really being able to do what you do and knowing that you actually helped somebody.*”

Kongklusyon

Sa kabuoan hindi madali ang maging isang medikal frontliner lalo na sa panahon ng pandemya. Maraming mga bagay na dapat isaalang-alang katulad na lamang ng mga bagong protokol at ang takot na mahawa sa sakit. Gayunpaman sa kabila ng mga stress at burnout na nararanasan ng mga medikal na frontliners nanatili pa rin sila sa kanilang sinumpaang tungkulin at patuloy nilang nalalagpasan ang mga hamon nang dahil sa kanilang motibasyon at coping mechanisms.

Rekomendasyon

Batay sa isinagawang pag-aaral inirerekomenda ang mga sumusunod:

1. Magkaroon ng komparatibong pag-aaral hinggil sa naging pagtugon ng mga doktor sa pandemya sa Pilipinas.
2. Alamin at suriin din ang mga karanasan ng mga Frontliners na hindi doktor o nars, upang malaman din ang kanilang mga naging karanasan.

4. PASASALAMAT

Taus-pusong pasasalamat ang aming ipinaaabot sa mga sumusunod na indibidwal at tanggapan dahil sa mahahalagang tulong, kontribusyon at/o suporta tungo sa matagumpay na reyalisasyon ng pananaliksik na papel na ito:

1. Sa mga kalahok na doktor na nakilahok sa pakikipanayam na naglaan ng panahon at sumagot nang matapat sa aming inihandang talatanungan.
2. Kay **Krees P. Castaneda** na nagsisilbing inspirasyon at tulay upang makahanap ng mga kalahok, at sa paggabay sa mga mananaliksik sa pagbuo ng isang pananaliksik na papel.
3. Kay **Dr. Mary Anne Cecilia P. Castaneda** na nagsilbing inspirasyon at tulay upang makahanap ng mga kalahok, at sa paggabay sa mga mananaliksik sa pag-intindi ng mga termino sa medisina,
4. Kay **Mr. Patrick Alexander P. Castaneda**, na nagsilbing tulay upang makahanap ng mga kalahok, editor at mananaliksik ng mga akdang pinaghanguan namin ng mahahalagang impormasyong aming ginamit sa pagsulat ng una at ikaapat na kabanata ng pananaliksik na papel,
5. Kay **Bb. Abbygale C. Pinca**, masigasig naming dalubguro na gumabay sa amin sa tamang hakbangin sa pagsulat at paggawa ng isang pananaliksik na papel,
6. Sa aming mga **magulang at pamilya**, sa pag-unawa, paghintulot at pagsuporta sa buong



proseso ng paggawa ng mga mananaliksik sa pananaliksik na papel,

7. Sa **Poong Maykapal**, sa pagdinig sa aming mga dalangin lalung-lalo na sa sandaling kami ay pinanghihinaan na ng pag-asang matapos naming ito nang maayos sa itinakdang-panahon.

Muli ay maraming Salamat po!

5. SANGGUNIAN

Deng, S., Yang, N., Li, S., Wang, W., Yan, H., & Li, H. (2018). Doctors' job satisfaction and its relationships with doctor-patient relationship and work-family conflict in China: a structural equation modeling. *INQUIRY: The Journal of Health Care Organization, Provision, and Financing*, 55, 0046958018790831.

Duarte, I., Teixeira, A., Castro, L. et al. (2020). Burnout among Portuguese healthcare workers during the COVID-19 pandemic. *BMC Public Health*, 20, pp. 1-10. <https://doi.org/10.1186/s12889-020-09980-z>

Fried, A. L., & Fisher, C. B. (2016). Moral stress and job burnout among frontline staff conducting clinical research on affective and anxiety disorders. *Professional Psychology: Research and Practice*, 47(3), 171. <https://doi.org/10.1037/pro0000060>

Gračanin, A., Bylsma, L. M., & Vingerhoets, A. J. (2014). Is crying a self-soothing behavior?. *Frontiers in Psychology*, 5, 502. 10.3389/fpsyg.2021.604692

Johnson, S. B., & Butcher, F. (2021). Doctors during the COVID-19 pandemic: what are their duties and what is owed to them?. *Journal of Medical Ethics*, 47(1), 12-15. 10.1136/medethics-2020-106266

Mills, J., Wand, T., & Fraser, J. A. (2018). Exploring the meaning and practice of self-care among palliative care nurses and doctors: a qualitative study. *BMC Palliative Care*, 17(1), 1-12. <https://doi.org/10.1186/s12904-018-0318-0>

Lambert, V. A., & Lambert, C. E. (2008). Nurses' workplace stressors and coping strategies. *Indian Journal of Palliative Care*, 14(1), 38. <https://doi.org/10.4103/0973-1075.41934>

Mahmood, Q. K., Jafree, S. R., Jalil, A., Nadir, S. M. H., & Fischer, F. (2021). Anxiety amongst physicians during COVID-19: cross-sectional study in Pakistan. *BMC public health*, 21(1), 1-10. <https://doi.org/10.1186/s12889-020-10134-4>

Magsambol, B. (2021, Enero 11). PH logs over 2,000 COVID-19 cases for first time since holidays. *Rappler*. <https://www.rappler.com/nation/coronavirus-cases-philippines-january-11-2021>

Ratanawongsa, N., Howell, E. E., & Wright, S. M. (2006). What motivates physicians throughout their careers in medicine?. *Comprehensive therapy*, 32(4), 210-217. <https://doi.org/10.1007/BF02698065>

Salvagioni, D. A. J., Melanda, F. N., Mesas, A. E., González, A. D., Gabani, F. L., & Andrade, S. M. (2017). Physical, psychological and occupational consequences of job burnout: A systematic review of prospective studies. *PLOS ONE*, 12(10), pp. 1-29. <https://doi.org/10.1371/journal.pone.0185781>

Sarada, P.A. & Ramkumar, B. (2015). Positive stress and its impact on performance. *Research Journal of*

Pharmaceutical, Biological and Chemical Sciences. 6(2), pp. 1519-1522. https://www.researchgate.net/publication/282700608_Positive_stress_and_its_impact_on_performance

Talabong, R. (2020, Marso 14). Metro Manila lockdown begins. *Rappler*. <https://www.rappler.com/nation/coronavirus-metro-manila-lockdown-begins>

Yaribeygi, H., Panahi, Y., Sahraei, H., Johnston, T. P., & Sahebkar, A. (2017). The impact of stress on body function: A review. *EXCLI journal*, 16, pp. 1057-1072. <https://doi.org/10.17179/excli2017-480>

Zhang, Y., Wang, C., Pan, W., Zheng, J., G, J., Huang, X., Cai, S., Zhai, Y., Latour, J. M., & Zhu, C. (2020). Stress, Burnout, and Coping Strategies of Frontline Nurses During the COVID-19 Epidemic in Wuhan and Shanghai, China. *Frontiers in psychiatry*, 11, pp. 1-9. <https://doi.org/10.3389/fpsyg.2020.565520> <https://www.cdc.gov/coronavirus/2019-ncov/testing/serology-overview.html>



Mango (*Mangifera indica*) Bark Aqueous Extract as Antimicrobial Spray

Kenneth A. Morales, Jomari B. Carandang, Marben J. Javier,
and Rein Lester L. Tatco

Taytay Senior High School, Taytay, Rizal

Abstract: Emerging microbial agents have been increasing in number. Microbial agents are necessary in combating microbes such as bacteria that cause viruses and diseases. Hence, some bacteria are being resistant to antioxidant and antibacterial drugs that is why it resulted to find antimicrobial agents coming from organic molecules. This reason resulted in the researchers finding an organic antimicrobial agent using Mango Bark Aqueous Extract (MBAE). In the previous studies, it was proven that *Mangifera indica* (Mango) has phytochemicals that help inhibit the growth of bacteria. Thus, the researchers screened the antimicrobial activity of MBAE by applying the MBAE with a concentration of 50 mg/ml to the cultured microbes. The researchers selected chicken meat samples within the vicinity of Taytay, Rizal marketplace in March 2021. The sample was used to culture the microbes to be treated. The microbes were cultured on Nutrient agar over 24 hours under room temperature then the MBAE was applied by dropping an adequate amount of the extract on the plate and spreading it until the surface is fully covered. After twenty-four hours, the extract almost inhibited the growth of microbes on the plate. This justifies the claims regarding the potential usage of the Mango Bark Aqueous Extract as an antimicrobial agent.

Key Words: mango aqueous extract; antimicrobial screening; microbial agents; microbes; bark.

1. INTRODUCTION

The mango belongs to genus *Mangifera*, which consists of numerous species of tropical fruits in the family of *Anacardiaceae*. *Mangifera indica* L. is native to India and Southeast Asia where it has been cultivated for over 4000 years for the good qualities of the fruits. Currently, mango is also grown in Central America, Africa, Australia, and for a few years in Europe (Lauricella et al., 2017).

According to the study of Scartezzini et al. (2000, as cited by Ghuniyal, 2015), aqueous extract is traditionally used for the treatment of, syphilis, anemia, scabies, cutaneous infections, menorrhagia, and diarrhea. In line with it, as the aqueous extract shows that it combats different bacteria onto these diseases, the bark infusion has been used to treat mouth sores. In the study of Sanusi et al. (2011), the antimicrobial activity of the aqueous and methanolic extract of *Mangifera indica* stem bark both inhibits the growth of *Pseudomonas aeruginosa*, *Staphylococcus aureus* and *Escherichia coli* at a concentration of 50 mg/ml of the reconstituted extract. Similarly, Abubakar (2009), as cited by Osei-Djarbeng et al. (2020), has studied and found that the bark extract of the plant has exhibited antimicrobial activity against *Staphylococcus aureus* and *Escherichia coli*, *Staphylococcus aureus*,

Pseudomonas aeruginosa, *Klebsiella pneumoniae* and *Streptococcus pneumoniae*. Moreover, in the study Prado et al. (2015), they stated that some studies have been performed in Cuba from one standardized aqueous stem bark of mango extract they isolated and purified mangiferin. Mango bark contains mangiferin (Nwoke et al., 2016; Govindan, 2019; Sani et al., 2015) and other phytochemical constituents. According to Stoilova et al. (2005) as cited by Tyagi et al. (2019), in an in vitro agar diffusion technique, mangiferin showed activity against 7 bacterial species, *Bacillus pumilus*, *B. cereus*, *Staphylococcus aureus*, *S. citreus*, *Escherichia coli*, *Salmonella agona*, *Klebsiella pneumoniae*, 1 yeast (*Saccharomyces cerevisiae*) and 4 fungi (*Thermoascus aurantiacus*, *Trichoderma reesei*, *Aspergillus flavus* and *A. fumigatus*).

Given this data, the researchers are encouraged to conduct experiments in testing the antimicrobial efficacy of the MBAE. The researchers will synthesize Mango (*Mangifera indica*) bark as antimicrobial spray for possible product development. This study aims to justify the potential of the MBAE as an organic antimicrobial agent.

1.1 Theoretical Framework

Resistance to antimicrobial drugs has become an increasingly important and pressing global



problem (Savant et al., 2017). Resistance of microorganisms to antibiotics and orthodox drugs has resulted in finding antibacterial agents that came from organic molecules from plants that have antibacterial properties (Sanusi et al., 2011). According to the study of Savant et al. (2017), there has been a ruthless increase in antimicrobial resistance in most of the pathogenic microorganisms all over the world due to irrational use of antimicrobial agents. Therefore, the use of antibacterial properties of Mango (*Mangifera indica*) bark extract is significant to the foregoing research.

Nworie et al. (2016), stated that the chance to find antibacterial property on both leaves and bark extract of the Mango were apparent, therefore, they suggested that the plant could be a new source of antibiotics. Accordingly, the study of Mazlan et al. (2019), mangiferin and its derivative compounds is a safe natural product, which can potentiate antibacterial effects of some antibiotics suggesting good potential for combination therapy against *S. aureus*. Likewise, the study of Savant et al. (2017), also showed the extract's potential antibacterial activity against different Gram positive and Gram-negative bacteria by performing MIC and zone of inhibition. Interestingly, these results encourage the researchers to carry out further study for its clinical use.

1.2 Research Question

Does the MBAE inhibits microbes?

1.3 Scope and Delimitation

This study focused mainly on the effect of antimicrobial properties of Mango on microbes collected on chicken meat samples.

This study is limited since the microbes collected on the chicken meat sample were not identified and verified. In addition, the researchers did not use positive and negative control in the experiment.

2. METHODOLOGY

2.1 Research Design

The researchers used Pretest and Posttest Control Group Design. They selected the test organisms on raw chicken samples at Taytay, Rizal public market in March 2021. The test organism was pre-tested, without the application of the MBAE, observed and post-tested after 24 hours of the application of the MBAE. After 24 hours of observation the treated plate was analyzed and drawn to a conclusion.

2.2 Selections and Trials

All the conclusions were drawn only after the testing of organisms on collected chicken sample. The purpose of taking samples was to randomly select test organisms on the raw chicken sample to get the data and information, which conclusions are drawn.

2.3 Proposed Product

Figure 1

MBAE as antimicrobial spray



2.4 Procedures

2.4.1 Collection of Plant Materials

Samples of Mango (*Mangifera indica*) tree bark were obtained from Taytay Rizal.

2.4.2 Preparation of Plant Materials

Freshly collected stem barks of *M. indica* were thoroughly cleaned and washed with water and were dried under sunlight with a span of three days. After drying the stem bark, it was pounded with mortar and pestle to obtain smaller pieces and then powdered using an electric blender. 150 grams of the powdered stem bark of the *M. indica* was stored in a container until required.

2.4.3 Preparation of Aqueous Extract

The researchers used five grams of the dried powdered sample soaked in 100 ml of distilled water contained in a container. The container was covered and then stored for 24 hours. After 24 hours, the suspension was shaken vigorously and filtered using filter paper. The extract was stored 24 hours under room temperature. After 24 hours, the 50 mg/ml extract was used in the antimicrobial screening.

2.4.4 Preparation of Microbial Media

As suggested by the manufacturer's specification, 8.4g of Nutrient agar was dissolved in 300ml of distilled water. After the agar was dissolved the solution was then autoclaved. After autoclaving,

the nutrient agar was poured on petri dishes and allowed to harden under room temperature. The plates were then inoculated with the test organisms and then treated by 50 mg/ml concentration of MBAE.

2.4.5 Collection of Test Organisms

Test organisms were obtained upon culturing microbes from the raw chicken food sample. The test organisms were cultured on Nutrient Agar. The researchers swabbed the surface of the food sample using sterile swabs and transferred it into the nutrient agar plate in a side-by-side motion. The plates were incubated at a room temperature for 24 hours.

3. RESULTS AND DISCUSSION

1. Does the MBAE inhibits microbes?

This study's finding intends to show antimicrobial activity of the MBAE on the test organism within the time interval: 5:50 PM, 6:00 PM, 9:00 PM, 10:00 PM, 7:00 AM, 12:00 PM, 3:00 PM, 5:50 PM.

Figure 2
The antimicrobial activity of the MBAE on the test organism within 24 hours.



Figure 3
Effect of the MBAE to the test organism after incubation for 24 hours.

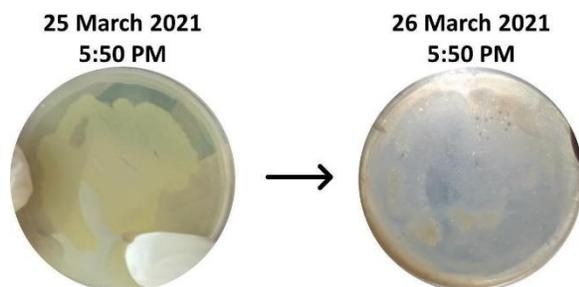

Through 24 hours of observation, the results were gathered and analyzed. The results showed that at the concentration of 50 mg/ml, the growth of microbes has been inhibited. As shown on Figure 2 the first ten minutes of the application of the extract the results were visible that MBAE acted fast. Continuously, the 24 hours of observation showed that

every time interval after the application of the MBAE it showed significant effect that it inhibits the growth of microbes.

As the study of Sanusi et al. (2011), stated that in their phytochemical screening, aqueous extract of Mango bark has the presence of tannins, saponins, sterols, cardiac glycosides, flavonoids, and alkaloids. Mango bark also contains mangiferin (Nwoke et al., 2016; Govindan, 2019; Sani et al., 2015), which is, according to Stoilova et al. (2005, as cited by Tyagi et al., 2019), showed activity against 7 bacterial species, *Bacillus pumilus*, *B. cereus*, *Staphylococcus aureus*, *S. citreus*, *Escherichia coli*, *Salmonella agona*, *Klebsiella pneumoniae*, 1 yeast (*Saccharomyces cerevisiae*) and 4 fungi (*Thermoascus aurantiacus*, *Trichoderma reesei*, *Aspergillus flavus* and *A. fumigatus*).

4. RECOMMENDATION

This study only focused on the 50 mg/ml concentration of the extract. There are still concentrations suggested by Sanusi et al. (2011), to be explored. The concentration showed inhibition to the growth of microbes in the sample. To further know the efficacy of the extract on foodborne bacteria, it is suggested to find different food samples like meat, vegetable, and fruit regarding also from where these food samples come from. It is also suggested to use identified and verified test organisms, use verified methods in finding the inhibitory effect, and conduct a positive and negative control to the experiment.

5. ACKNOWLEDGEMENTS

The researchers want to express their deepest gratitude to Dr. Ma. Victoria C. Magayon for her unending support and lessons for the researchers to continue their study.

They also give most of their thanks to Mr. Dante Panalangin Jr. as their research adviser for his guidance and teaching throughout the journey of experimentations.

The researchers also want to give a large place of acknowledgement for their families that guide them every day, bring what they need and for their uncontrollably support and understanding.

There is also a great space here for the researchers' friends that are always there when they need comfort and moral support.

Above all, the researchers want to offer their gratefulness to the God the Father for giving them strength and knowledge in the journey. For his almighty love and hope that reminds everyone to always move forward and continue life.



6. REFERENCES

- Bykowski, T., & Stevenson, B. (2008). Aseptic technique. *Current protocols in microbiology*, 11(1), A-4D.
- Ghuniyal, J. (2015). Ethanomedical, chemical, pharmacological, toxicological properties of mangifera indica: a review. *International Journal of Pharma Research & Review*, 4(10), 51-64.
- Kemegne, G. A., Nyegue, M. A., Kamdem, S. L. S., Etoa, F. X., & Menut, C. (2018). *Mangifera indica* Bark Essential Oil: Chemical Composition and Biological Activities in Comparison with Aqueous and Ethanol Extracts. *Natural Product Communications*, 13(7), 1934578X1801300730.
- Mazlan, N. A., Azman, S., Ghazali, N. F., Yusri, P. Z. S., Idi, H. M., Ismail, M., & Sekar, M. (2019). Synergistic antibacterial activity of mangiferin with antibiotics against *Staphylococcus aureus*. *Drug Invention Today*, 12, 14-17.
- Noghogne, L. R., Gatsing, D., Kodjio, N., Sokoudjou, J. B., & Kuate, J. R. (2015). In vitro antisalmonellal and antioxidant properties of *Mangifera indica* L. stem bark crude extracts and fractions. *British Journal of Pharmaceutical Research*, 5(1), 29.
- Nworie, O., Orji, J. O., Ekuma, U. O., Agah, M. V., Okoli, C. S., & Nweke, M. C. (2016). Antibacterial activity of the leaf and stem bark of *Irvingia gabonensis* (Bush Mango) against *Escherichia coli* and *Staphylococcus aureus*. *Global Journal of Pharmacology*, 10(1), 13-18.
- Osei-Djarbeng, S. N., Kwarteng, R. O., Osei-Asante, S., & Owusu-Dapaah, G. (2020). Comparative antimicrobial activities of ethanolic extracts of leaves, seed and stem bark of *Mangifera indica* (Mango). *Journal of Pharmacognosy and Phytochemistry*, 9(1), 1240-1243.
- Phytochemical screening and antimicrobial efficacy of aqueous and methanolic extract of *Mangifera indica* (mango stem bark).
- Sanusi, B. M., GARBA, A., MUHAMMAD, A., MOHAMMED, A., & David, O. (2011).
- Savant, C. B., Kulkarni, A. R., Abdel-Wahab, B. A., Al-Qahtani, A. M., Mannasaheb, B. A., & Shaikh, I. A. (2017). Phytochemical characterization and Antibacterial potentials of *Mangifera indica* L. bark oil. *Journal of Applied Pharmaceutical Science*, 7(04), 138-141.
- Singh, R., Singh, S. K., Maharia, R. S., & Garg, A. N. (2015). Identification of new phytoconstituents and antimicrobial activity in stem bark of *Mangifera indica* (L.). *Journal of pharmaceutical and biomedical analysis*, 105, 150-155.
- Tyagi, U., Dwivedi, S. P., & Bagchi, S. (2019). Evaluation of antimicrobial and antioxidant properties of *Mangifera indica* bark extracts to prolong the shelf life of fruits and food products. *Journal of Biopesticides*, 12(2).
- VAGANINA Caillouette, J. C., Sharp Jr, C. F., Zimmerman, G. J., & Roy, S. (1997). Vaginal pH as a marker for bacterial pathogens and menopausal status. *American journal of obstetrics and gynecology*, 176(6), 1270-1277.



A Review on the Antioxidant Activity of Select Philippine Fruits and Wines

Kyle Nicole P. Babista, Rowell Andrew A. Kalalang, Frances Ivy C. Mesina
and Lara Nicole B. Pegalan
De La Salle University Integrated School, Manila

Dr. Joseph R. Ortenero
De La Salle University, Manila

Abstract: Antioxidants are an abundant type of substance that is found in various fruits and wines. The literature on antioxidants has been growing consistently due to various reports on their health benefits. Hence, this study is a literature review of the antioxidant activity of local fruit and wines in the Philippines using various spectrophotometric techniques. Specifically, the researchers assessed the state of research on the antioxidant properties of local fruits and the effect of temperature and aging on the antioxidant activity of local wines. In gathering the related studies, the following keywords/phrases were used: “antioxidant activity of Philippine wines,” “spectrophotometry,” “Philippine fruit”, and “temperature and age of Philippine wines.” These were assessed using the Quality of Reporting of Meta-analyses (QUORUM) standard to measure its reliability. The results showed that there was a correlation between the temperature of both local fruits and wines towards the antioxidant ($x^2c = 1.53$, $\alpha = 2.71$; $x^2c = 5.00$, $\alpha = 6.25$, respectively). However, the age of the wine did not display any relationship with its antioxidant ($x^2c = 11.56$, $\alpha = 6.25$). As for the heterogeneity of the studies, there was a considerable heterogeneity for the temperature of the fruits and wines towards the antioxidant ($I^2 = 34.64\%$; $I^2 = 40.00\%$). But the data for the age and wine were varied significantly since it accounted for a high heterogeneity ($I^2 = 82.69\%$). In conclusion, there was a mildly significant correlation between the temperature of both fruit and wines towards the antioxidant activity. However, the wine age did not affect its antioxidant activity.

Key Words: Philippine fruits; antioxidant activity; Philippine wines; spectrophotometry; heterogeneity

1. INTRODUCTION

As of modern-day, the Philippines is not known for its wine production. However, its climate and culture contribute to its significant consumption and production of wine. The Philippine winery produces various types of wine which are commonly associated with the plants that grow locally. As a result, most of the wines that are being produced in the country are mostly local fruits such as strawberries, mangoes, pineapple, mangosteen, calamansi, and bignay (Morelock, 2018).

The antioxidants, which are sometimes called free-radical scavengers are considered to be a type of substance that has the ability to prevent or slow down the damage to the cells that are caused by free radicals (Morelock, 2018). Wines and fruits alike are found to have a significant amount of antioxidants which are commonly in the form of polyphenols, flavonoids, etc. (Barcelo, 2015). These compounds offer a lot to the human body because they aid in a lot of biological

processes like anti-cancer or anti-inflammatory activities (Han et al., 2017).

The objective of this literature review is to provide sufficient information about the antioxidant activity of local fruit and wines that utilize various spectrophotometric techniques. The obtained literature will then be compared with each other in terms of the concluded results and the parameters observed in the experimentation process. For the fruit samples, the parameter that is considered is the temperature to which the sample was subjected during the experiment. Meanwhile, for the local wines, the parameters that are analyzed are the temperature during the experiments and the age of the local wines from the day of packaging. The review journal articles that were studied all took place in the Philippines and must use spectrophotometric techniques in acquiring data.



2. METHODOLOGY

The study is an intensive review of the Philippines' local papers about fruit and wines and their antioxidant levels. The researchers used various academic search engines in order to scour different articles. Among a few of the research engines used are Google Scholar, ScienceDirect, ResearchGate, Academia, and Philippine E-journal. To search for the relevant articles, the researchers used search strings such as "Antioxidant activity of Philippine wines", "spectrophotometry", "Philippine fruit", and "temperature and age of Philippine wines." The journal articles were assessed using the Quality of Reporting of Meta-analyses (QUORUM) standard. The researchers carefully filtered the articles utilizing a checklist to ensure the validity of the study's publications. The relevant data were presented in tabular form by indicating its age, temperature, and antioxidant activity. But for the fruits, only the temperature and antioxidant activity were indicated. Additionally, the chi-square test and Higgins' I2 heterogeneity statistic were used to assess the relationship of age and temperature on the antioxidant activity. This will be computed through a Microsoft Excel add-in called PHStat.

3. RESULTS AND DISCUSSION

Among the studies that have been searched, the researchers picked 31 pieces of literature based on the title and abstract of the paper. It consisted of both foreign and local literature therefore all the literature were consequently deducted by checking the criterion (see Table 1). Therefore, only 6 studies met the criterion which also needed to have a reliable result.

Table 1. The criteria used in the selection of studies

Parameter	Criteria
Date and Year	2005-2021
Author	Any author would suffice
Language	English
Research Status	Scholarly (Peer-reviewed)
General Setting	The antioxidant activity of Philippine fruit/wines using spectrophotometric techniques
Methodology	Meta-analysis of journal articles using key terms to search the journal article repositories (ScienceDirect, Philippine E-journal, Google Scholar, and ResearchGate)
Publication	Any database that offers scholarly articles

Spectrophotometric techniques are methods that are reliant on the reaction of a radical, radical cation, or a complex antioxidant molecule that can donate a hydrogen ion. The 2,2-diphenyl-1-picrylhydrazyl DPPH method consists of a stable free radical which is caused by the delocalization of the spare electron within the totality of a molecule. The

2,2'-azino-bis(3-ethylbenzothiazoline-6-sulfonic acid) (ABTS) method is a cation that is formed due to the loss of electrons from the nitrogen atom of ABTS which is a type of acid. The Ferric Reducing Antioxidant Potential (FRAP) method relies on the reduction of certain species through an antioxidant of the ferric ion. The Oxygen Radical Absorbance Capacity (ORAC) method measures the scavenging activities of the antioxidant against a peroxy radical.

Table 2. Summary of the different spectrophotometric methods

Antioxidant capacity assay	Principle of the method	End-product determination
DPPH	Antioxidant reaction with an organic radical	Colorimetry
ABTS	Antioxidant reaction with an organic cation radical	Colorimetry
FRAP	Antioxidant reaction with a Fe(III) complex	Colorimetry
PFRAP	Potassium ferricyanide reduction by antioxidants and subsequent reaction of potassium ferrocyanide with Fe ³⁺	Colorimetry
CUPRAC	Cu (II) reduction to Cu (I) by antioxidants	Colorimetry
ORAC	Antioxidant reaction with peroxy radicals, induced by AAPH (2,2'-azobis-2-amidino-propane)	Loss of fluorescence of fluorescein
HORAC	Antioxidant capacity to quench OH radicals generated by a Co(II) based Fenton-like system	Loss of fluorescence of fluorescein
TRAP	Antioxidant capacity to scavenge luminol-derived radicals, generated from AAPH decomposition	Chemiluminescence quenching
Fluorimetry	Emission of light by a substance that has absorbed light or other electromagnetic radiation of a different wavelength	Recording of fluorescence excitation/ emission spectra

Note. Table 2 shows the process and result of the spectrophotometric methods (Pisoschi & Negulescu, 2012).

The Hydroxyl Radical Averting Capacity (HORAC) method relies on measuring the metal-chelating activities of antioxidants under Fenton-like conditions (ferric reactions). The Total peroxy Radical-trapping Antioxidant Parameter (TRAP) method involves luminol enhanced chemiluminescence (CL) being exploited to measure the peroxy radicals. The lipid peroxidation inhibition assay is a type of inhibition that uses a Fenton-like method to induce a lipid substance. The Potassium Ferricyanide Reducing Power (PFRAP) method involves the reducing capabilities of an antioxidant to reduce a ferric into a ferrous substance. The Cupric Reducing Antioxidant Power (CUPRAC) assay is a method wherein antioxidants are mixed with copper to be reduced. Lastly, Fluorimetry is utilized by exposing the antioxidant for it to emit a light that will emit energy (Pisoschi & Negulescu, 2003).

Garcia et al. (2005) acquired the bignay and durian from IFST and Davao City, respectively. The samples were kept and incubated at 37°C in a hot water bath. The experiment utilized the Lipid-peroxidation assay (Linoleic-acid) and resulted in an



84.44% antioxidant activity for the bignay and 90.76% for the durian. The study from Santiago et al. (2007) also used the Lipid-peroxidation assay to effectively identify the antioxidant of the local duhat and kalumpit. An 80.38% activity is found in duhat while kalumpit garnered 66.15% in their antioxidants. Additionally, Barcelo et al. (2015) employed the use of DPPH assay in their experiment involving pineapple, guyabano, strawberry, mangosteen, and ayosep fruit. All of these were kept under room temperature and yielded an antioxidant activity of 62.39%, 86.41%, 92.35%, 89.08%, and 80.02%, respectively. Lastly, a study by Lizardo et al. (2015) also aimed to study the antioxidant activity of bignay under 4oC. The DPPH assay was used and the result came out as the fruit having 87.10%.

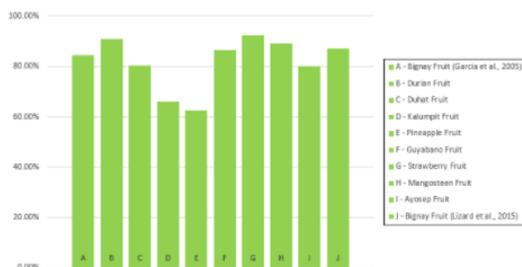

Figure 1. Comparison of the antioxidant activity of select Philippine fruits

Kalumpit Fruit	Lipid-peroxidation assay	40 C	66.15%	Santiago et al. (2007)
Pineapple Fruit	DPPH radical scavenging assay	25 C	62.39%	Barcelo et al. (2015)
Guyabano Fruit	DPPH radical scavenging assay	25 C	86.41%	Barcelo et al. (2015)
Strawberry Fruit	DPPH radical scavenging assay	25 C	92.35%	Barcelo et al. (2015)
Mangosteen Fruit	DPPH radical scavenging assay	25 C	89.08%	Barcelo et al. (2015)
Ayosep Fruit	DPPH radical scavenging assay	25 C	80.02%	Barcelo et al. (2015)
Bignay Fruit	DPPH radical scavenging assay	4C	87.10%	Lizardo et al. (2015)

The study by Hipol & Alma-in (2018) focused on tapuy, a rice wine that originated from the Cordillera regions, and assessed different variants of tapuy, each variant coming from different municipalities of Benguet. The researchers found out through the use of DPPH assay with ascorbic acid as the standard curve that the tapuy from Sablan had the most antioxidant activity to which was quantitated at 88.5%. Next, the tapuy from Trinidad ranked the lowest in antioxidant activity at 50.00%. Tapuy from the municipalities of Atok, Kapangan, Bokod, Tublay, and Tuba were calculated at 65.1%,

71.3%, 68.6%, 63.6%, and 76.6% respectively. 50 µL of each of the tapuy variants were analyzed at 37°C and were between 15-21 days old.

Dela Rosa & Medina (2021) is another research study that experimented on different types of rice wine with each wine differing in their originating rice varieties. The DPPH radical scavenging assay was used against the standard curve of gallic acid in order to determine the different wine samples' antioxidant activity. According to the researchers, the rice wine that was made from black rice (Ballatinao) had the highest antioxidant activity at 70.63% while the rice wine made from white rice (Bongkitan) had the lowest antioxidant activity at 45.44%. For the remaining rice wine varieties; red rice (Kintoman) and brown rice (Tinawon) had antioxidant activities of 57.66% and 57.20% respectively.

On the other hand, Barcelo et al. (2015) utilized the standard curve of gallic acid that was prepared in 80% methanol to quantify the results of the samples. The 6-month-old sample wines were left in a dark room at room temperature after being shaken thoroughly. The guyabano wine had the most % DPPH radical scavenging activity at 90.38% (±2.51), mangosteen wine had second-most at 89.55% (±0.76), then ayosep wine at 74.4% (±2.99), followed by strawberry wine at 69.95% (±12.8), and pineapple wine at 62.39% (±12.3).

Zubia & Dizon (2018) formulated their own fruit wines by blending three types of wines together with different proportions to compare the samples' antioxidant activity. The standard used was gallic acid to estimate the total phenolic contents of the different wine blends with the Folin-Ciocalteu method. 1000 µL of the sample wines were analyzed at room temperature after aging them for 3 months. The authors stated that the MPAPF blend's antioxidant activity is at 44.47%, then the 2M blend's is at 45.26%, the 2PA's blend at 42.67%, and lastly, the 2PF's blend is at 41.27%.

Table 4. Antioxidant activity of local wines evaluated using spectrophotometric techniques.

Type of Wine	Analytical Technique	Quantity of Wine Analyzed	Temperature	Age	Antioxidant Activity	Author and Year
Tapuy wine (Sablan, Benguet)	DPPH radical scavenging assay	50 µL	37°C	15-21 days	88.5%	Hipol & Alma-in (2018)
Tapuy wine (Trinidad, Benguet)	DPPH radical scavenging assay	50 µL	37°C	15-21 days	50.0%	Hipol & Alma-in (2018)
Tapuy wine (Atok, Benguet)	DPPH radical scavenging assay	50 µL	37°C	15-21 days	65.1%	Hipol & Alma-in (2018)
Tapuy wine (Kapangan, Benguet)	DPPH radical scavenging assay	50 µL	37°C	15-21 days	71.3%	Hipol & Alma-in (2018)
Tapuy wine (Bokod, Benguet)	DPPH radical scavenging assay	50 µL	37°C	15-21 days	68.6%	Hipol & Alma-in (2018)
Tapuy wine (Tublay, Benguet)	DPPH radical scavenging assay	50 µL	37°C	15-21 days	63.6%	Hipol & Alma-in (2018)
Tapuy wine (Tuba, Benguet)	DPPH radical scavenging assay	50 µL	37°C	15-21 days	76.6%	Hipol & Alma-in (2018)
Tapuy wine (Bongkitan)	DPPH radical scavenging assay	100 µL	25°C	7 days	45.44%	Dela Rosa & Medina (2021)
Tapuy wine (Tinawon)	DPPH radical scavenging assay	100 µL	25°C	7 days	57.20%	Dela Rosa & Medina (2021)



continuation ...

Type of Wine	Analytical Technique	Quantity of Wine Analyzed	Temperature	Age	Antioxidant Activity	Author and Year
Tapuy wine (Kintoman)	DPPH radical scavenging assay	100 μ L	25°C	7 days	57.66%	Dela Rosa & Medina (2021)
Tapuy wine (Baliatnaga)	DPPH radical scavenging assay	100 μ L	25°C	7 days	70.63%	Dela Rosa & Medina (2021)
Guyabano wine	DPPH radical scavenging assay	75 μ l	25°C	6 months	90.33% (\pm 2.51)	Barcelo et al. (2015)
Strawberry wine	DPPH radical scavenging assay	75 μ l	25°C	6 months	69.95% (\pm 12.8)	Barcelo et al. (2015)
Mangosteen wine	DPPH radical scavenging assay	75 μ l	25°C	6 months	89.55% (\pm 0.76)	Barcelo et al. (2015)
Ayosep wine	DPPH radical scavenging assay	75 μ l	25°C	6 months	74.4% (\pm 2.99)	Barcelo et al. (2015)
MPAF*	DPPH radical scavenging assay	1000 μ L	25°C	3 months	44.47%	Zubia & Dizon (2018)
2M**	DPPH radical scavenging assay	1000 μ L	25°C	3 months	45.26%	Zubia & Dizon (2018)
2PA***	DPPH radical scavenging assay	1000 μ L	25°C	3 months	42.67%	Zubia & Dizon (2018)
2PF****	DPPH radical scavenging assay	1000 μ L	25°C	3 months	41.27%	Zubia & Dizon (2018)

Note:
 *MPAFF 33.33% mango wine + 33.33% pineapple wine + 33.33% passion fruit wine;
 **2M - 50.00% mango wine + 50.00% pineapple wine + 50.00% passion fruit wine;
 ***2PA - 25.00% mango wine + 50.00% pineapple wine + 25.00% passion fruit wine;
 ****2PF - 25.00% mango wine + 25.00% pineapple wine + 50.00% passion fruit wine

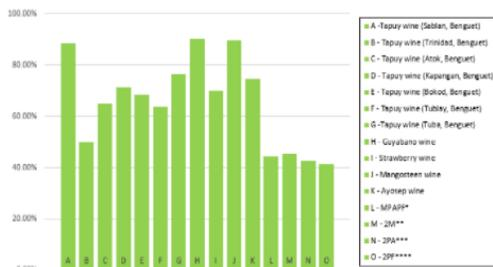

Figure 2. Comparison of antioxidant activity of various locally-available wines.

Statistical treatment was carried out in order to know the effects of temperature and age on the local wines and the effect of temperature on the fruits. The chi-square test was used to relate the age and temperature towards the antioxidant activity. As a result, the wine temperature and the antioxidant activity were found out to have a moderate correlation with each other ($\chi^2c = 1.53, \alpha = 2.71$). Additionally, its age was found to have no significant correlation to the antioxidant activity of the wines ($\chi^2c = 11.56, \alpha = 6.25$). But, the fruit temperature and its antioxidant activity were also found to have a significant correlation much like the wines ($\chi^2c = 5.00, \alpha = 6.25$). Besides the relationship of the variables, Higgins' I² heterogeneity statistics was utilized to find the variety of results in the given studies. The relationship between the wine temperature and antioxidant activity showed moderate heterogeneity (I² = 34.64%). Additionally, the age had a significant heterogeneity with the antioxidant (I² = 82.69%) while the fruit temperature was mildly homogenous with the antioxidant activity (I² = 40.00%).

4. CONCLUSIONS

With the results that the researchers have gathered, the fruit with the highest antioxidant activity was the strawberry fruit (Barcelo et al., 2015) and as for the wines, the wine with the highest

antioxidant activity was the guyabano wine from the same study. Based on the available data, the researchers concluded that the antioxidant activity of both wines and fruits are affected by the temperature that they were subjected to while the age of wines do not. Additionally, the heterogeneity was also considerable in the data involving the antioxidant activity in relation to both temperatures in fruit and wine (I² = 34.64%; I² = 40.00%). But the heterogeneity of the antioxidant in regards to age is significantly high (I² = 82.69%) which concludes that the data are not that associated with each other. In conclusion, the temperature of the wine and fruit has a direct correlation to the antioxidant activity while the wine age does not have an important role.

Recommendations

Given the limited amount of data available about the antioxidant activity of Philippine fruits and wines, the researchers suggest that future studies should have more data to further confirm the findings in this paper. Specifically, a longer range of temperature from 0°C to 100°C and a longer age frame of wines from 7 days to 10 years would be more beneficial to better understand the relationship between the parameters of local fruits and wines.

5. ACKNOWLEDGMENTS

First of all, the researchers would like to express their utmost gratitude and appreciation to their research advisor, Dr. Joseph R. Ortenero, from the Chemical Engineering department for the generous support and patience in guiding them with the research manuscript. The group is sincerely grateful for the opportunity to have been graced with his wisdom and knowledge. His insights have truly been beneficial and will always be etched in the minds of the researchers.

Additionally, to the group's family and friends who have given their unconditional support and encouragement by being the source of their inspiration.

Lastly, the researchers are also grateful for the help of the university, De La Salle University-Manila, for pushing the students to always do their best especially in the field of research. The researchers will always uphold the university's values in school and beyond.

6. REFERENCES

Barcelo, R.C. (2015). Phytochemical Screening and Antioxidant Activity of Edible Wild Fruits in Benguet, Cordillera Administrative Region, Philippines. *Electronic Journal of Biology*, 11.



- Barcelo, R., Basilio, A., Calsiyao, I., Mabesa, C., Palconete, R., & Tobias, J. (2015). Antioxidant Property and Total Polyphenol and Flavonoid Content of Selected Fruits and Fruit Wines. *Philippine E-Journal for Applied Research and Development*, 5(2015), 57-64. Retrieved from <http://pejard.slu.edu.ph/vol.5/2015.12.17.pdf>.
- Garcia, V. V., Magpantay, T. O., & Escobin, L. D. (2005). Antioxidant Potential of Selected Philippine Vegetables and Fruits, 88(1), 78–83. https://www.researchgate.net/publication/281550680_Garcia_VV_Magpantay_T_o_and_Escobin_L_D2005_Antioxidant_potential_of_selected_vegetables_and_fruits_Phil_Agricultural_Scientist_88_178-83.
- Han, F., Ju, Y., Ruan, X., Zhao, X., Yue, X., Zhuang, X., f... Fang, Y. (2017). Color, anthocyanin, and antioxidant characteristics of young wines produced from spine grapes (*Vitis davidii* Foex) in China. *Food & Nutrition Research*, 61(1), 1339552. doi:10.1080/16546628.2017.1339552
- Hipol, R. B., & Alma-in, A. B. (2018). Antioxidant potentials of indigenously produced Benguet tapuy (rice wine). *International Food Research Journal*, 25(5), 1968-1976. Retrieved from [http://www.ifrj.upm.edu.my/25%20\(05\)%202018/\(29\).pdf](http://www.ifrj.upm.edu.my/25%20(05)%202018/(29).pdf)
- Lizardo, R. C., Mabesa, L. B., Dizon, E. I., & Aquino, N. A. (2015). Functional and antimicrobial properties of bignay [*Antidesma bunius* (L.) Spreng.] extract and its potential as natural preservative in a baked product. *International Food Research Journal*, 22(1), 88-95. Retrieved from [http://www.ifrj.upm.edu.my/22%20\(01\)%202015/\(14\).pdf](http://www.ifrj.upm.edu.my/22%20(01)%202015/(14).pdf)
- Morelock, J. (2018, March 21). Wineries in the Philippines. <https://traveltips.usatoday.com/wineries-philippines-100846.html>
- Pisoschi, A. M., & Negulescu, G. P. (2012). Methods for Total Antioxidant Activity Determination: A Review. *Biochemistry & Analytical Biochemistry*, 01(01). doi:10.4172/2161-1009.1000106
- Santiago, D. O., Garcia, V. V., Dizon, E. I., & Merca, F. E. (2007). Antioxidant Activities, Flavonol and Flavanol Content of Selected Southeast Asian Indigenous Fruits. *Philippine Agricultural Scientist*, 90(2), 123-130. Retrieved from https://www.researchgate.net/publication/281550813_SANTIAGO_D_M_O_V_V_GARCIA_E_I_DIZON_and_F_E_MERCA_2007_Antioxidant_Activities_Flavonol_and_Flavanol_Content_of_Selected_Southeast_Asian_Indigenous_Fruits_Phil_Agricultural_Scientist_90_2123-130
- Zubia, C. S., & Dizon, E. I. (2019). Physico-chemical, antioxidant and sensory properties of artificially-carbonated fruit wine blends. *International Food Research Journal*, 26(1), 217-224. [http://www.ifrj.upm.edu.my/26%20\(01\)%202019/\(24\).pdf](http://www.ifrj.upm.edu.my/26%20(01)%202019/(24).pdf)



Effects of Different Drying Methods on Extractable Phenolic Compounds from Turkey Berry (*Solanum torvum*) Leaves

Mikaela Vivienne M. Bautista, Jennifer Love D. Calajate,
Zandrew Peter C. Garais and Jela May B. Yap
De La Salle University Integrated School, Manila

Abstract: In the Philippines, there is an abundance of plants rich in phenolic compounds such as *Solanum torvum* (turkey berry), a plant with antifungal, antibacterial, anticancer, antimicrobial, and antiviral properties; however, there is not much information on the extraction of its phenolics, especially on the best drying method that will give the highest yield. Drying reduces water which allows better extraction of the said phenolics, but different drying methods expose the phenolics to possible degradation. In this study, the effect of different drying methods, namely sun-drying, freeze-drying, and microwave-drying on the extraction of total phenolics from *S. torvum* leaves was investigated. The dried leaves were macerated to determine the best drying method that would give the highest content of phenolic compounds from *S. torvum* leaves. Sun-drying, the most energy-efficient method, resulted in the highest extraction yield of 2.14 ± 0.01 mg GAE/g d.w., which was significantly different from the yields of microwave-drying and freeze-drying. Freeze-drying resulted in the lowest yield of 1.02 ± 0.01 mg GAE/g d.w., while microwave-drying yielded 1.58 ± 0.03 mg GAE/g d.w. Due to the photosensitivity of the freeze-dried samples and the high temperature of microwave-drying, phenolic compounds have degraded resulting in lesser yields. Although microwave-drying yielded less than sun-drying, it is the most efficient drying method out of the three as it is more energy-efficient than freeze-drying and less time-consuming than the others.

Key Words: solanum torvum; phenolic compounds; drying methods; maceration; total phenolic content (tpc)

1. INTRODUCTION

1.1. Background of the Study

Solanum torvum (turkey berry), shown in Figure 1, is widely distributed in the Philippines (Centre for Agriculture and Bioscience International, 2014). It contains phenolic compounds (see Appendix A), some of which possess anticancer, anticonvulsant, anti-inflammatory, and anti-diabetic properties (Kaunda & Zhang, 2019). Extraction of these compounds would maximize the use of this plant in different fields, especially medicine.

Figure 1
Solanum torvum Plant



Source: Photo by J. Velasco, CC0.00

All extraction methods of bioactive compounds from plants utilize drying. Drying reduces moisture while minimizing transportation and preservation costs and lengthening the sample's shelf life since bacteria and enzymes cannot proliferate under dry conditions (Pham et al., 2015; Ahmed et al., 2013). The reduction of water also increases the yield of phenolic compounds since enzymes in water degrade phenolic compounds (Ghomari et al., 2019). Extraction yield may vary depending on the drying method and temperature used since these factors can diminish bioactive compounds (Mbondi et al., 2018).

In this study, sun-drying, freeze-drying, and microwave-drying were utilized. Sun-drying exposes samples under direct sunlight. It was selected as a natural drying method for this experiment as it is widely used in similar studies (Roshanak et al., 2015). In freeze-drying, samples are frozen to let the water evaporate by sublimation, preserving the quality of bioactive compounds as there is no heat present (Thamkaew et al., 2020). Microwave-drying uses microwave electromagnetic radiation that reduces drying time, resulting in higher nutrient yield (Babu et al., 2018). Microwave-drying dries leaves within a short duration, while freeze-drying produces the



highest phenolic compounds and antioxidant quality, making them viable for investigation (Babu et al., 2018). With the advantages and disadvantages of these methods, this study aims to utilize different drying methods in extracting the highest yield of total phenolic content (TPC) present in *Solanum torvum* leaf.

1.2. Statement of the Problem

Plants with medicinal potential are endemic in the Philippines. However, more research should be done on these endemic plants with phenolic compounds such as *Solanum torvum* for the utilization of their beneficial compounds. Moreover, research on the drying methods and extraction techniques on these plants is not widely emphasized. Drying methods maximize the extraction of phenolic compounds for the utilization of their medicinal properties. However, certain parameters may degrade phenolic compounds. Thus, the researchers propose to investigate the effects of different drying methods on the phenolic content of *Solanum torvum* leaves.

1.3. Research Objectives

The general objective of this study is to determine the drying method that will yield the highest amount of phenolic compounds from *Solanum torvum* leaf via maceration. In order to accomplish the main objective, these specific objectives were followed:

1. To investigate the effect of the drying method on the amount of phenolic compounds extracted.
2. To identify the best drying method for *Solanum torvum* based on the yield of phenolic compounds, drying time, and energy consumption.

1.4. Scope and Limitations

This study focuses on the extraction of bioactive compounds in *Solanum torvum*, specifically phenolics. However, this study does not aim to identify the specific compounds nor demonstrate their effectiveness. It only investigated the effect of sun-drying, freeze-drying, and microwave-drying on the yield of phenolic compounds from *S. torvum* leaves. Only the drying method was tested. The dried samples were all macerated at room temperature. Data analysis was performed to compare the TPC obtained through phytochemical analysis and determine which among the three (3) drying methods produced the highest yield.

1.5. Significance of the Study

The leaves of *Solanum torvum* hold great potential in medical remedies with their abundance in medicinal

properties and microbial activities. The medicinal constituents of the plant material can be obtained through extraction techniques such as maceration. However, the drying methods used may affect the extraction yield. Hence, results in investigating different drying methods that would give the highest TPC from this plant can maximize resources for developing natural remedies and medicine in the Philippines. Furthermore, this study may provide further knowledge on harvesting phenolic compounds from the plant for treating diseases and infections through the recommendation of the ideal drying method for maceration on *S. torvum*. Similar future studies may be provided with an initial standard of optimizing maceration of bioactive compounds from *S. torvum* from which they can improve with a broader scope.

2. METHODOLOGY

Sun-drying, freeze-drying, and microwave-drying were employed as independent variables to investigate the effect of each method on the phenolic extraction yield of *S. torvum* leaves. The dried samples were macerated for extraction. Using the Folin-Ciocalteu (F-C) method, the TPC of the extracts was quantified. The yields were then compared through statistical means to determine whether there is a significant difference between the drying methods. Figure 2 summarizes the methodology.

Figure 2
Flowchart of the Study

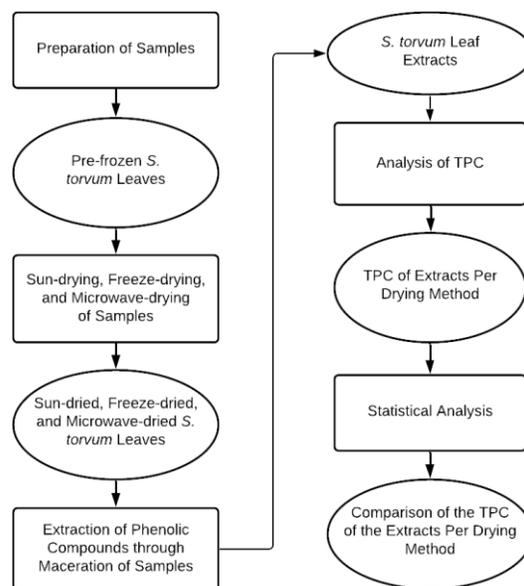



2.1. Materials

2.1.1. *Solanum torvum* Leaf Samples

Samples of *Solanum torvum* leaves were acquired from a local farm in Dasmariñas, Cavite.

2.1.2. Reagents

The extraction process utilized 80% aqueous ethanol. Its polarity encouraged researchers to recognize ethanol as a good solvent for retrieving polyphenols from plant extracts (Do et al., 2014).

The Folin-Ciocalteu reagent (FCR) was used to determine TPC of the extracts in terms of gallic acid concentration. It is highly reactive to bioactive compounds such as phenols (Everette et al., 2010). Gallic acid was also utilized as the analytical reference curve for obtaining the values of the TPC. Lastly, sodium carbonate enabled the reaction of the FCR and phenols as it increases the pH level of the solution.

2.1.3. Microwave

An American Home AMW-25 mechanical microwave oven was used for microwave-drying. It has an input power of 1200 W and a power output of 700 W. It has six power levels: low, defrost, medium-low, medium, medium-high, and high.

2.1.4. Freeze-Dryer

A SCIENTZ-18N Lyophilizer Manufacturers Vacuum Function Freeze-dryer with a base temperature of less than -56°C was utilized for freeze-drying. It has an input power of 1300 W.

2.2. Experimental Procedure

2.2.1. Preparation of Samples

After collection, the fresh *Solanum torvum* leaves were transferred to an airtight container and stored in a freezer with a temperature of -20°C to preserve the samples until they were needed.

2.2.2. Design of Experiment

The experiment was done under a full-factorial design (2^k levels where k is the number of factors) with the drying method as the only varying parameter. Duplicate runs of drying were done. The results of each run were macerated for 12 hours. Phytochemical analysis of its constituents was performed through the Folin-Ciocalteu method.

2.2.3. Drying of Samples

The samples were subjected to sun-drying, microwave-drying, and freeze-drying. The weight of

the leaves before and after drying were recorded to determine the moisture content using Equation 1,

$$\% \text{ moisture content} = \frac{M_0 - M}{M_0} \times 100 \quad (1)$$

where M_0 is the mass of the sample before drying and M is the mass of the sample after drying.

2.2.3.1. Sun-Drying

The samples were dried in direct sunlight for four (4) hours and stored in a Ziplock plastic bag with desiccant. They were refrigerated until the next day to repeat the drying process until a constant weight was achieved. The sun-drying process took four days.

2.2.3.2. Microwave-Drying

Two containers of *S. torvum* leaves were microwaved for 18 minutes per trial at a medium power level of 462 W, equating to a temperature of around 148.9°C to 190.6°C (Superb1.ca, 2016).

2.2.3.3. Freeze-Drying

Pre-frozen samples were lyophilized in a freeze-dryer for eight (8) hours at a temperature below 0°C and a pressure of 20 millibars (mbar).

2.2.4. Extraction of Phenolic Compounds

Phenolic compounds in *S. torvum* leaves were extracted from the powdered samples in 80% aqueous ethanol through maceration. In a loosely sealed glass vessel, 10 grams (g) of the sample was soaked in 100 milliliters (mL) of the solvent for 12 hours at room temperature. The solids were then separated from the extract using a filter paper. The liquid was refrigerated until it was needed for analysis.

2.2.5. Analysis of Total Phenolic Content

The Folin-Ciocalteu method by Abdulkadir et al. (2016) on the extraction of total phenolic compounds from *Solanum torvum* was followed with some modifications. This method is anchored to the reaction of the oxidant reagent and tyrosine, which exhibits the protein concentration of the extract (Sánchez-Rangel et al., 2013). First, 250 microliters of the sample extract was diluted in a test tube with ethanol. Then, 1.25 mL of FCR was diluted in distilled water with a volume-to-volume ratio of 1:9. The solution was then incubated at room temperature. After 10 minutes, 1 mL of 8% sodium carbonate solution was added. The solution was incubated again for 30 minutes. Using a spectrophotometer, the sample's absorbance was determined at 650 nanometers. Gallic acid was used as the standard. The



TPC was expressed as gallic acid equivalent (mg GAE/g).

2.2.6. Statistical Analysis

One-way ANOVA (analysis of variance) using Analysis ToolPak was performed at 95% confidence level (p-value=0.05) to compare the phenolic content of the *S. torvum* leaf extracts per drying method.

3. RESULTS AND DISCUSSION

3.1. Moisture Content of the *Solanum torvum* Leaves

Sun-drying, freeze-drying, and microwave-drying were used to investigate the moisture content of the *S. torvum* leaves. The moisture content was computed using Equation 1, ranging from 72.19% to 77.41% as seen in Table 1.

Table 1
 Moisture Content of the *Solanum torvum* Leaves

Drying Method	Trial	Initial Mass (g)	Final Mass (g)	Moisture Content (%)
Sun-Drying	1	119.8	33.32	72.19
	2	107.4	26.83	75.02
Freeze-Drying	1	110.3	27.2	75.34
	2	111.1	26.7	75.97
Microwave-Drying	1	120.01	27.11	77.41
	2	120.1	27.73	76.91

3.2. Total Phenolics Extracted from Dried *Solanum torvum* Leaves

A calibration curve (see Appendix C) with an R² of 0.9958 was constructed by measuring the absorbance of a standard solution at different concentrations. The equation from the calibration curve for extrapolating the concentration of phenolic compounds in terms of mg gallic acid equivalent/mL is shown in Equation 2,

$$GAE_{volume} = \frac{(abs) - (-0.02356)}{3.7376} \quad (2)$$

where GAE_{volume} is the gallic acid equivalent (GAE) of phenolics per milliliter and *abs* is the absorbance of the extract solution reacted with the FCR.

The extraction yield in terms of mg GAE/g was calculated using Equation 3,

$$GAE_{mass} = \frac{GAE_{volume} \times V_{extract}}{m_{sample}} \quad (3)$$

where GAE_{mass} is the GAE of phenolics per gram of powdered sample, GAE_{volume} is the GAE of phenolics per milliliter, V_{extract} is the volume of extract collected

from maceration, and m_{sample} is the mass of powdered sample in grams.

The values calculated using Equations 2 and 3 are shown in Table 2.

Table 2
 Absorbance, Phenolic Content, and Extraction Yield of the *S. torvum* Samples

Trial	Drying Method	Absorbance	Phenolic Content (mg GAE/mL extract)	Extraction Yield (mg GAE/g d.w.)
1	Sun-Drying	1.710	0.464	2.129
	Microwave-Drying	0.994	0.272	1.607
	Freeze-Drying	1.320	0.359	1.024
2	Sun-Drying	1.658	0.450	2.155
	Microwave-Drying	1.049	0.287	1.547
	Freeze-Drying	1.389	0.378	1.009

3.3. Effect of Parameters on Phenolics Yield

The TPC of each drying method derived from spectrophotometric analysis was compared by their extraction yield per trial. Sun-drying resulted in higher extraction yields from the maceration of dried *S. torvum* leaves. An average of 2.14±0.01 mg GAE/g d.w. was extracted from samples sun-dried for 16 hours, reaching maximum temperatures of 31°C to 33°C. Meanwhile, the drying of *S. torvum* leaves using a medium-powered microwave with a temperature of around 148.9°C to 190.6°C for 18 minutes returned an average of 1.58±0.03 mg GAE/g d.w. Samples freeze-dried at a temperature below 0°C for eight hours gave the lowest extraction yield of only 1.02±0.01 mg GAE/g d.w.

Table 3
 Parameters and Extraction Yield of Each Drying Method

Drying Method	Energy Consumption (W)	Drying Time (hours or minutes)	Extraction Yield (mg GAE/g d.w.)
Sun-Drying	0	16 hours	2.142
Microwave-Drying	462	18 minutes	1.577
Freeze-Drying	1300	8 hours ^a	1.017

^aThe samples were left inside the freeze-dryer for around 30 hours.

As shown in Table 3, sun-drying took the longest time to dry the samples but yielded the most phenolic compounds without energy consumption. Microwave-drying took a significantly shorter drying period than the former but yielded lesser phenolics with greater energy consumption. Freeze-drying required the most energy and a longer drying period than microwave-drying yet derived the least phenolic compounds. Sun-drying is the most energy-efficient drying method out of the three, however, it is weather-dependent and uncontrollable. Meanwhile, microwave-drying is the most time-efficient as it yields a significant amount of phenolics while consuming less time. However, further study is needed to optimize microwave-drying and freeze-drying to extract more bioactive compounds in *S. torvum*.



Table 4

One-way ANOVA of Extraction Yield from *S. torvum* Leaves Dried Using Different Methods

Source of Variation	Sum of Squares	df	Mean Square	F	P-value	F crit
Between Groups	1.26606704	2	0.633034	844.7076	7.46E-05	9.552094
Within Groups	0.002248234	3	0.000749			
Total	1.268315274	5				

The statistical analysis through one-way ANOVA is shown in Table 4. A p-value of less than 0.05 was obtained, showing that there is a significant difference between the extraction yields of *S. torvum* leaves dried using different methods.

Figure 3
 Average Extraction Yield of Phenolic Compounds from *S. torvum* Leaves

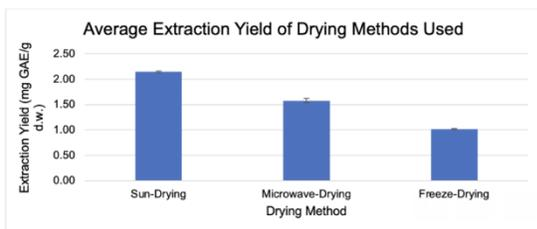

As shown in Figure 3, sun-dried samples had the highest yield, while the microwave-dried leaves had lower yields than the former, possibly due to high temperatures. Orphanides et al. (2013) elaborated that the degradation and instability of heat-sensitive phenolics in their samples might have caused their microwave- and oven-dried samples to yield the least phenolic contents. Meanwhile, freeze-dried samples yielded the lowest TPC among the three. Freeze-dried leaves are usually susceptible to atmospheric moisture and oxygen, resulting in destabilization and loss of bioactive compounds (Labconco, 2010). Overall, microwave-drying is the most efficient method for the extraction of *Solanum torvum* leaves as it has the shortest drying period, increasing its potential to produce larger volumes of extracts for medicinal use.

4. CONCLUSIONS

This study investigated the effect of three different drying methods on the TPC of *Solanum torvum* leaf extracts. Among them, sun-drying yielded the highest amount of TPC while consuming the least energy. Freeze-drying yielded the least amount of phenolic compounds while consuming the most energy, making it the least favorable drying method for *Solanum torvum* leaves.

Microwave-drying is the best drying method for *Solanum torvum* leaves in terms of drying time. Its

extracts yielded a greater amount of TPC than the freeze-dried extracts despite having the shortest drying time among the three and consuming less power than freeze-drying.

5. ACKNOWLEDGMENTS

This research may have not been completed without the assistance of many individuals. The researchers would like to thank the following for their consistent support.

To their research adviser, Dr. Cynthia Madrazo, for her recommendations that lead to the improvement of their research, for providing revisions to their research manuscript, for her continued guidance in the face of difficulties, and her effort to push through the experimentation amid the national crisis.

To Engr. Sherlock Pestaño from the Chemical Engineering Instrumentation Laboratory of De La Salle University - Manila for providing the researchers much needed assistance for the freeze-drying and spectrophotometric analysis of samples.

To Mr. Joseph Viñegas for providing the *Solanum torvum* leaves.

To their loved ones, for their encouragement and assistance that helped the researchers continue this research.

Lastly, to the Heavenly Father, for providing strength and wisdom to the researchers during the study.

6. REFERENCES

- Abdulkadir, A., Mat, N., Hasan, M., & Jahan, M. (2016). In vitro antioxidant activity of the ethanolic extract from fruit, stem, and leaf of *Solanum torvum*. *ScienceAsia*, 42(3), 184. <https://doi.org/10.2306/scienceasia1513-1874.2016.42.184>
- Ahmed, N., Singh, J., Chauhan, H., Anisa Anum, P. G. A., & Kour, H. (2013). Different Drying Methods: Their Applications and Recent Advances. *International Journal of Food Nutrition and Safety*, 4(1), 34–42. https://www.researchgate.net/publication/275650176_Different_Drying_Methods_Their_Applications_and_Recent_Advances
- Babu, A. K., Kumaresan, G., Raj, V. A. A., & Velraj, R. (2018). Review of leaf drying: Mechanism and influencing parameters, drying methods, nutrient preservation, and mathematical models. *Renewable and Sustainable Energy Reviews*, 90, 536–556. <https://doi.org/10.1016/j.rser.2018.04.002>
- Centre for Agriculture and Bioscience International (2014, February 28). *Solanum torvum* (turkey berry). <https://www.cabi.org/isc/datasheet/50559>
- Do, Q. D., Angkawijaya, A. E., Tran-Nguyen, P. L., Huynh, L. H., Soetaredjo, F. E., Ismadji, S., & Ju, Y.-H. (2014). Effect of extraction solvent on total phenol content, total flavonoid content, and antioxidant activity of *Limnophila aromatica*. *Journal of Food and Drug Analysis*, 22(3), 296–302. <https://doi.org/10.1016/j.jfda.2013.11.001>



- Everette, J. D., Bryant, Q. M., Green, A. M., Abbey, Y. A., Wangila, G. W., & Walker, R. B. (2010). Thorough Study of Reactivity of Various Compound Classes toward the Folin-Ciocalteu Reagent. *Journal of Agricultural and Food Chemistry*, 58(14), 8139–8144. <https://doi.org/10.1021/jf1005935>
- Ghomari, O., Sounni, F., Massaoudi, Y., Ghanam, J., Drissi Kaitouni, L. B., Merzouki, M., & Benlemlih, M. (2019). Phenolic profile (HPLC-UV) of olive leaves according to extraction procedure and assessment of antibacterial activity. *Biotechnology Reports*, 23, e00347. <https://doi.org/10.1016/j.btre.2019.e00347>
- Kaunda, J. S., & Zhang, Y. J. (2019). The Genus *Solanum*: An Ethnopharmacological, Phytochemical and Biological Properties Review. *Natural Products and Bioprospecting*, 9, 77–137. <https://doi.org/10.1007/s13659-019-0201-6>
- Labconco. (2010). A Guide To Freeze Drying for the Laboratory [Pamphlet]. https://condor.depaul.edu/jmaresh/instruments/Instruments/Freeze%20Dry/guide_fd.pdf
- Mbondo, N. N., Owino, W. O., Ambuko, J., & Sila, D. N. (2018). Effect of drying methods on the retention of bioactive compounds in African eggplant. *Food Science & Nutrition*, 6(4), 814–823. <https://doi.org/10.1002/fsn3.623>
- National Center for Biotechnology Information (2021, May 8). PubChem Compound Summary for CID 3314, Eugenol. <https://pubchem.ncbi.nlm.nih.gov/compound/Eugenol>
- National Center for Biotechnology Information (2021, May 8). PubChem Compound Summary for CID 338, Salicylic acid. <https://pubchem.ncbi.nlm.nih.gov/compound/Salicylic-acid>
- National Center for Biotechnology Information (2021, May 8). PubChem Compound Summary for CID 689075, Methyl caffeate. <https://pubchem.ncbi.nlm.nih.gov/compound/Methyl-caffeate>
- National Center for Biotechnology Information (2021, May 8). PubChem Compound Summary for CID 88563, 2,4,6-Trimethoxyphenol. https://pubchem.ncbi.nlm.nih.gov/compound/2_4_6-Trimethoxyphenol
- Orphanides, A., Goulas, V., & Gekas, V. (2013). Effect of drying method on the phenolic content and antioxidant capacity of spearmint. *Czech Journal of Food Sciences*, 31(5), 509–513. <https://doi.org/10.17221/526/2012-cjfs>
- Pham, H., Nguyen, V., Vuong, Q., Bowyer, M., & Scarlett, C. (2015). Effect of Extraction Solvents and Drying Methods on the Physicochemical and Antioxidant Properties of *Helicteres hirsuta* Lour. Leaves. *Technologies*, 3(4), 285–301. <https://doi.org/10.3390/technologies3040285>
- Roshanak, S., Rahimmalek, M., & Goli, S. A. H. (2015). Evaluation of seven different drying treatments in respect to total flavonoid, phenolic, vitamin C content, chlorophyll, antioxidant activity and color of green tea (*Camellia sinensis* or *C. assamica*) leaves. *Journal of Food Science and Technology*, 53(1), 721–729. <https://doi.org/10.1007/s13197-015-2030-x>
- Sánchez-Rangel, J. C., Benavides, J., Heredia, J. B., Cisneros-Zevallos, L., & Jacobo-Velázquez, D. A. (2013). The Folin-Ciocalteu assay revisited: improvement of its specificity for total phenolic content determination. *Analytical Methods*, 5(21), 5990. <https://doi.org/10.1039/c3ay41125g>
- Schauer, J. J., Kleeman, M. J., Cass, G. R., & Simoneit, B. R. T. (2001). Measurement of Emissions from Air Pollution Sources. 3. C1–C29 Organic Compounds from Fireplace Combustion of Wood. *Environmental Science & Technology*, 35(9), 1716–1728. <https://doi.org/10.1021/es001331e>
- Simaratanamongkol, A., Umehara, K., Niki, H., Noguchi, H., & Panichayupakaranant, P. (2014). Angiotensin-converting enzyme (ACE) inhibitory activity of *Solanum torvum* and isolation of a novel methyl salicylate glycoside. *Journal of Functional Foods*, 11, 557–562. <https://doi.org/10.1016/j.jff.2014.08.014>
- Superb1.ca. (2016, February 10). Basic Microwave Tips. <http://www.superb1.ca/Microwave%20Tips/BASIC%20MICROWAVE%20TIPS.pdf>
- Thamkaew, G., Sjöholm, I., & Galindo, F. G. (2020). A review of drying methods for improving the quality of dried herbs. *Critical Reviews in Food Science and Nutrition*, 1–24. <https://doi.org/10.1080/10408398.2020.1765309>
- Viñegas, J. (2020). [Photograph of *Solanum torvum* plant].

7. APPENDICES

Appendix A

Table A1

*Phenolic Compounds of *Solanum torvum**

Compounds	Part	Properties
Methyl caffeate	Fruit	Antibacterial, antidiabetic
(E)-2,3-dihydroxycyclopentyl-3-(3',4'-dihydroxyphenyl)acrylate	Fruit	Antihypertensive
Salicylic acid	Aerial	
2,4,6-Trimethoxyphenol	Stem	
Propionylsyringol	Stem	
Eugenol	Stem	

Note. Adapted from “The Genus *Solanum*: An Ethnopharmacological, Phytochemical and Biological Properties Review” by J.S. Kaunda & Y.J. Zhang, 2019, *Natural Products and Bioprospecting*, 9, pp. 77–137

Table A2
Structures of Phenolic Compounds of Solanum torvum

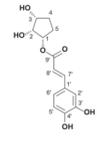
Compounds	Structure	Reference
Methyl caffeate		National Center for Biotechnology Information, 2021
(E)-2,3-dihydroxycyclopentyl-3-(3,4'-dihydroxyphenyl) acrylate		Singh et al., 2014
Salicylic acid		National Center for Biotechnology Information, 2021
2,4,6-Trimethoxyphenol		National Center for Biotechnology Information, 2021
Propionylsyringol		Schauer et al., 2001
Eugenol		National Center for Biotechnology Information, 2021

Appendix C

Figure C1
Calibration Curve

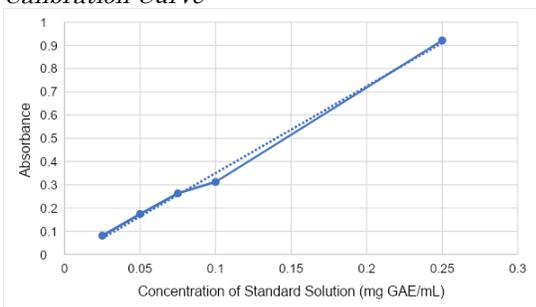



The Role of Dreams in the Assessment and Analysis of Mental Health Conditions from the Perspective of Mental Health Practitioners

Jemina Ranzel V. Dampil, Cyrene Gabrielle S. Fernando,
and Quinn Kirsten M. Nuestro
De La Salle University Integrated School, Manila

Abstract: Studies have proven that a person’s dreams and mental health condition have a connection with each other. In fact, major dream theories such as Freud’s and Jung’s have been the basis of practitioners in studying dreams. The purpose of this research is to explore the role of dreams in the assessment and analysis of mental health conditions. Moreover, this study focuses on the experiences and practices done by mental health practitioners with regards to their patient’s dreams. In this qualitative study, the researchers interviewed five mental health practitioners in the Philippines, specifically licensed psychologists and psychiatrists, given that they have the most experience in handling patients with mental health conditions. Through the semi-structured interviews with mental health practitioners, things such as the frequency of dream usage, its link to a person's conscious life, and what kinds are further examined were discussed. Dreams have also been described as an indicator for additional assessment, with the practitioners basing their chosen methods on the needs of their patients.

Key Words: dreams; unconscious; dream analysis; mental health conditions; mental health practitioners

1. INTRODUCTION

Dreams are a universal human experience that can be expressed as a state of consciousness characterized by sensory, cognitive, and emotional occurrences during sleep (Nichols, 2018). DerSarkissian (2019) mentioned that dreams can be entertaining, disturbing, or downright bizarre. It was even explained that the stresses in the waking life can be manifested in dreams. Additionally, according to dream research, a dream is viewed as a possible adaptive mode for processing emotional events (Phelps, et al., 2011, as cited in Pope, 2017). It was also explained that the content of dreams is often used for psychoanalysis, although less common as it was before, some doctors still look at dreams for diagnostic clues for medical disorders (Shiel, 2018).

Between the dreams of a person and the current state of their mental health exists a relationship, as emphasized in the book *Dreams and Mental Disorders* (2018). Given these facts, the researchers claim that dreams play a role in the assessment and analysis of various mental health conditions.

2. METHODOLOGY

This study is qualitative, and the primary data were collected through semi-structured online interviews. Moreover, the non-probability sampling method that was applied in this study is purposive sampling. Five mental health practitioners were purposively selected based on the following criteria: (1) a licensed psychologist or psychiatrist, (2) has at least 5 years of experience in the field, and (3) part of an established organization in the Philippines such as Philippine Psychiatric Association Inc. (PPA), Psychological Association of the Philippines (PAP), and Philippine Mental Health Association Inc (PMHA). The interviews were transcribed and analyzed using thematic analysis (Braun and Clarke, 2006).

3. RESULTS AND DISCUSSION

3.1 Mental Health Practitioners’ Analysis of Dreams

This section focuses on mental health practitioners’ way of analyzing their patients’ dreams. There are two major themes that emanated under this category: (1) types of dreams to be dwelled upon; and



(2) the role of mental health practitioners in the analysis of their patient's dreams.

3.1.1 Types of Dreams to be Dwelled Upon

It has been noted that there are specific types and themes of dreams that must be dwelled upon. According to Participant 5, nightmares and recurring dreams are the usual experiences of their patients. Also, people who are "poor experienced", such as those who were sexually molested or had a near-death experience have dreams that are very vivid like their actual experiences, most of which are recurring. Participant 1 even stated:

"If it's a recurring dream, you can make a clinical judgment that it may be related to what is being experienced by the person right now..."(I1)

Aside from this, participant 1 mentioned the common themes of dreams of their patients: chasing, marriage, and house dreams. Participant 5 also discussed that if the dream is obviously connected to the traumatic experience, that has to be dealt with, and the accompanying effect or the emotional attachment of the experience has to be confronted. Lastly, according to Participant 2, one must pay attention to numinous dreams:

"Numinous dreams are those that one can recall upon waking up. When the patient opens up about the dream, then I am sure that it's a numinous dream, because the person carries it throughout the day. Those are the ones that need to be dealt with."(I2)

3.1.2 The Role of Mental Health Practitioners in the Analysis of their Patient's Dreams

In analyzing dreams, there are different approaches done by mental health practitioners depending on their patient's needs. Participant 3 described that one approach is by getting all the elements of the dream. From that, they will get information or feelings from the patient extracted from their dreams. This shares the same method as Participant 2 where the psychologist will show the issue to the patient and ask them the same questions.

According to Participant 3, Cognitive Behavioral Therapy (CBT) is one of the approaches done by psychologists in assessing their patients' dreams in order to correct the thought patterns of the person. On the other hand, Participant 5 pointed out that they will first assess the significance of the dream, whether or not they are related to the patient's condition as they could only be ordinary.

Participant 1 also tackled what professionals do upon learning about their patients' dreams.

"It's a bit difficult to be the therapist if they will be the ones suggesting the meaning of the dream, so what we'll do is to ask the right questions, to lead the person to make sense."(I1)

3.2 The Connection of Dreams and Mental Health Condition According to Mental Health Practitioners

This section discusses the relation between dreams and a person's mental health condition. There are two major themes that stood out under this category: (1) dreams as an uncommon concept for mental health practitioners; and (2) dreams as a manifestation of the conscious life.

3.2.1 Dreams as an Uncommon Concept for Mental Health Practitioners

It has been found that the concept of dreams comes up rarely in the practice of mental health practitioners because it is only the patient who brings up their dreams. As mentioned by Participant 1:

"It is not a common thing. It's not something that a therapist will really bring in the picture unless there is a particular frame."(I1)

In addition, Participant 3 also explained that the topic about dreams only arises when the patient talks about it because this means that it bothers them:

"The tricky part in dreams is that it rarely comes up because it truly comes from the patient, So, if we're administering a mental status examination or an interview, the question "did you have a dream?" isn't generally included. Another reason that it's rare is that it doesn't get brought up unless the patient has courage or they want to." (I3)

3.2.2 Dreams as a Manifestation of the Conscious Life

It has been revealed that one's dreams and consciousness are inextricably linked. Participant 1 stated that in dreamwork, the theme of the dream is connected with what is happening to the person.

"We always say in dream work that our dream is not about the people we dream about; instead, our dream is all about ourselves. So even if you see friends, mothers, or whoever they are in your dream, it is all different aspects of yourself."(I1)



Participant 4 believes that dreaming is a manifestation of an individual's state of mental health.

"Studies say that nightmares are often experienced by those who are under distress and recurring nightmares in particular, and can be a warning of a disorder which I have also observed among my clients. Moreover, having frequent nightmares may suggest sleep disturbance which may lead to more problems for the client."(I4)

Participant 4 also sees the significance of the dream and its content if its random thoughts and imagery may be related to the client's recent or remote memory/experience, especially if it is related to the situation bringing distress to the client. Additionally, as stated by Participant 5, in general, dreams always represent what's going on in the psyche of the person.

"The manifest dream is the actual memory of the patient, whatever is going on during their dreams. The dynamic of it will depend on how the practitioners will be able to correlate the aspects of the dream clinically because some are quite deep."(I5)

3.3 Dreams in the Assessment of Mental Health Practitioners

This section discusses the involvement of dreams in the mental health practitioners' assessment of their patients. There are two major themes that emerged under this category: (1) dreams as a starting point for mental health practitioners, and: (2) main frameworks followed by mental health practitioners for dream analysis.

3.3.1 Dreams as a Starting Point for Mental Health Practitioners

This major theme dwells upon how mental health practitioners perceive dreams as a starting point and indication for further assessment. Firstly, Participant 3 mentioned how dreams would be a good entry point for discussion.

"Dreams would be a starting point for a good discussion on how to assess, specifically how the person is thinking, feeling, and reacting towards the dream. From the dream as a starting point, we will go deeper in terms of what the patient feels, and then it can be an expanding discussion, like going back to the reality or the possibility of having an experience in the past that the patient cannot forget. So for me, a dream is a good entry point for discussion during an actual therapy session."(I3)

Participant 3 also pointed out that the approach and assessment done by the psychologist will depend on the case or problem of their patient. On the other hand, Participant 4 points out the concept of dreams coming up during the initial mental status examination done to patients.

"A standard in my practice is to do a Mental Status Examination. Part of that is watching out for disturbances in thinking/form of thought that usually leads me to ask clients recent dreams they can recall or possibly recurring nightmares which may turn out to be significant in my assessment."(I4)

3.3.2 Major Dream Perspectives followed by Mental Health Practitioners in Dream Analysis

This section explains the psychoanalytic and psychodynamic perspectives followed by mental health practitioners in analyzing their patient's dreams. First, Participant 2 discussed that in line with Freud's psychoanalytic theory, he believes that there is always a sexual component in dreams. In addition, Participant 1 dwelled upon Freud's idea of the 'tip of the iceberg' or the things that we know about ourselves, explaining that the other aspects that we do not know are revealed in our unconscious. Participant 3 also expounds on the connection between dreams and past experiences:

"Dreams are more of psychoanalysis, like dwelling on the past. Something happened in the past which is why a person is who they are in the present. If the orientation is like that, the concept of dreams will most likely be included because it is part of the process of psychoanalysis."(I3)

On the other hand, Participant 5 focused on the psychodynamic perspective by relating dreams to a traumatic event.

"As long as the strong negative emotions attached to that experience are still there, our unconscious keeps on working. In fact, most of the traumatic experience will make way to the unconscious, because some of the patients cannot confront it during their consciousness."(I5)

3.4 Discussion

The results found by the researchers are proven to be supported by several studies conducted in the past. First, according to the study of Brown et al. (1995), therapists do not bring dreams unless the patient initiates it. This backs up the researchers' findings that dreams are rarely brought up in the



practice of mental health practitioners because the patient is the one who brings it up. Furthermore, some studies support the conclusion that dreams are linked to one's consciousness. Campbell et al. (2018) discovered that a person's level of frustration or satisfaction had an influence on dreams and how they were interpreted emotionally. They even came to the conclusion that those who had recurring dreams suffered more psychological defeat on a daily basis. Schredl (2018) also pointed out that patients with mental health disorders, particularly depression and schizophrenia, often have negative waking-life symptoms. In addition, the researchers observed that mental health practitioners follow Freud's theory of dreams, particularly psychoanalysis and psychodynamic perspectives. This supports the findings of Brown et al. (1995) that Freud's theory is one of the approaches that most clinicians rely on. Cushway and Sewell (2013, p. 11) also explained that dream writers collectively agree that Freud's theory of dreams was a key milestone that laid the groundwork and served as a basis for most succeeding theories.

4. CONCLUSIONS

The concept of dreams rarely comes up in the practice of mental health practitioners unless the patient brings it up. It has also been proven that dreams are linked to what is going on in a person's conscious life. Additionally, specific dreams such as numinous, chasing, and recurring are the ones that must be dwelled upon during intervention. Dreams are also a good starting point and indicator for further assessment, and practitioners' approaches are often based on their patient's needs. Finally, in analyzing their patients' dreams, mental health practitioners primarily rely on Freud's theory, particularly psychoanalytic and psychodynamic perspectives.

5. ACKNOWLEDGMENTS

We would like to express our sincere gratitude to our research adviser Dr. Jerome Cleofas, our homeroom adviser Sir Xavier Gentalian, our research coordinator Sir Christian Gopez, our panelists in Practical Research 2 Dr. Myla Arcinas and Dr. Melvin Jabar, our professors in Practical Research 1 and 2 Ms. Omega Danganan and Ms. Thelma Mingoa, and our friends and family. We are beyond grateful for all the help and encouragement you have given us.

6. REFERENCES

- Braun, V., & Clarke, V. (2006). Using thematic analysis in psychology. *Qualitative Research in Psychology*, 3(2), 77-101. doi: 10.1191/1478088706qp063oa
- Brown, G., Hall, S., Keller, J.W., Maier, K., Piotrowski, C., & Steinfurth, K. (1995). Use of dreams in therapy: A survey of clinicians in private practice. *Psychological Reports*, 76 (3), 1288-1290. doi:10.2466/pr0.1995.76.3c.1288
- Campbell, R., Weinstein, N., & Vansteenkiste, M. (2018). Linking psychological need experiences to daily and recurring dreams. *Motivation and emotion*, 42(1), 50-63. <https://doi.org/10.1007/s11031-017-9656-0>
- Cushway, D., & Sewell, R. (2013). *Therapy with Dreams and Nightmares* (2nd ed.). SAGE.
- DerSarkissian, C. (2019). *Dreams*. WebMD. <https://www.webmd.com/sleep-disorders/dreaming-overview>
- Nichols, H. (2018). What does it mean when we dream?. *Medical News Today*. <https://www.medicalnewstoday.com/articles/284378>
- Pope, K. (2017). *Dream-Based Interventions and Post-Traumatic Stress Disorder*. <https://alfredadler.edu/sites/default/files/Kurt%20Pope%20MP%202017.pdf>
- Schredl, M. (2018). *Dreams and Mental Disorders*. (pp. 123-146.). *Central Institute of Mental Health*.
- Shiel, W. (2018). *Medical definition of dreams*. MedicineNet. <https://www.medicinenet.com/script/main/art.asp?articlekey=8672>



WEARING CUT SLEEVES: Unpacking Narratives of Coming Out by Chinese Filipino LGBTQIA+

John Surname¹, Esther Surname² and Author Three^{1,*} (10 pt. Century)

Name of Research Adviser, Research Adviser (10 pt. Century)

¹ Affiliation (8 pt. Century)

Abstract: The act of coming out is a major decision for many members of the LGBT community. Many factors are affecting this, including the environment that an individual is in. The main goal of this study is to uncover and understand the experiences of Chinese Filipino LGBTQIA+ individuals as they come out to the people around them. Moreover, the researcher aims to discover how this decision affects the lives of these individuals and their relationships with others. The research gathered the necessary data by interviewing eight self-identified Chinese Filipino LGBT individuals. The responses in the interviews were analyzed and interpreted by the researcher through critical discourse analysis. After gathering the data, the researcher found that the experiences of everyone differed from each other, with the main influences including their preconceived notions of the LGBTQIA+ community, and their Chinese upbringing. However, the study also found that all respondents had shared threads of experience, including the importance of self-disclosure, hesitation in coming out to parents, and generally positive results for the individuals after coming out.

Key Words: coming out, LGBTQIA+, Chinese Filipino, queer, phenomenology

1. INTRODUCTION

1.1 Background of the Study

The process of coming out as a member of the LGBT community has been the center of interdisciplinary studies for several years (Brumbaugh-Johnson & Hull, 2018). For many members of the community, the decision to come out is a great challenge, especially when choosing to come out to one's family (Heatherington & Lavner, 2008). Though times are more modern and are generally seen as more accepting, LGBT individuals are still wary of coming out.

Within Chinese Filipino households, homosexuality is seen as distancing oneself from their Chineseness, and LGBT individuals have experienced alienation from their families since coming out (Baytan, 2000). Being LGBT goes against Chinese households' traditions and expectations, and children in many Chinese Filipino households experience guilt for their sexual orientation and gender identity (Chu, 2020). However, these LGBT people do not distinguish themselves from Chinese or Filipino and still choose to express themselves as LGBT and allow their identities to be known.

The study aims to understand the reasons for coming out to family and friends despite their hesitations and the stigma surrounding

homosexuality, made in conjunction with being Chinese Filipino, which can be perceived as an additional challenge in their coming out journey. It further studies the circumstances surrounding these individuals' coming out, including possible hesitations that they may have experienced due to preconceived notions, their environments, and other factors.

1.2 Theoretical Framework

The study took two theoretical frameworks, Queer Theory and Phenomenology, as it magnified the coming out of Chinese Filipino LGBTQIA+ based on their own experiences. The two worked together in producing a coherent narrative of how Chinese Filipino LGBT came out and the struggles that accompanied this decision.

1.2.1 Queer Theory

Queer Theory was developed by Butler (1990), contesting the status quo of defined identity categories. Instead, it suggests that human relationships are better seen by gender expression rather than by sex determinants.

One of the core concepts of Queer Theory is heteronormativity. This concept assumes that everyone is cisgender and heterosexual, thus necessitates that members of the LGBT community



"come out" to others and declare their separation from heterosexuality.

Sedgwick (1990) demonstrates the impact of language on sexuality and states that labels and labeled speech acts are ultimate proofs of the nature of one's sexuality. She asserts that sexuality is not merely dependent on the gender of the object of attraction but extends across a spectrum that encompasses the multiple ways that distinguish people sexually. The socially constructed labels of homosexual and heterosexual are inadequate for such a spectrum. She argues that these categories must be examined, and seeing how such categories manifest and are perceived in society is more critical than their denotative meaning.

Queer Theory is the most appropriate to use in this study, as it is the most suited to deal with topics focusing on LGBT issues. As an act of verbalizing one's own sexuality, the process of coming out is a show of proving identity, and it is important to more deeply understand the perceptions of people in society toward these labels that LGBT individuals who come out attach to themselves.

1.2.2 Phenomenology

Phenomenology was first presented by Edmund Husserl, who argued that people could only be certain about how things appear in their surroundings because of their personal experiences and consciousness and rejected the belief that the external world exists independently from the person (Groenewald, 2004).

Phenomenology seeks to describe meanings of people's experiences in terms of what was experienced and how it was experienced. It assumes that the researcher must turn to the self to discover the true nature of things. Phenomenology states that the subjective and objective are intertwined, and understanding the world's objective realities requires an understanding of people's subjective experiences.

This is the most appropriate for the study, as it focuses on people's experiences and seeks to understand and describe them accurately to reflect their realities.

1.3 Statement of the Research Problem

This study's main objective is to understand the process of coming out as LGBT for Chinese Filipinos. It seeks the narratives of these Chinese Filipino LGBT in their coming out. Specifically, the study aims to answer the following questions:

- How do Chinese Filipino LGBTs come out?

- How did significant people in the lives of Chinese Filipino LGBTs react after they came out?
- How did coming out affect the lives of Chinese Filipino LGBTs and their relationship with others?

2. METHODOLOGY

2.1 Research Design

This study was a qualitative study on the experiences of Chinese Filipino LGBT in coming out to the people around them. Qualitative research collects data in a non-numerical manner and uses a variety of data sources to gain a more intimate understanding of the participants (Nassaji, 2015). Since this topic dealt with people's narratives and experiences, a qualitative design was the most appropriate for the study.

More specifically, this research was a phenomenological study. A phenomenological study aims to understand and describe phenomena by exploring them through the perspectives of people who have experienced them (Neubauer et al., 2019). As the study sought the narratives of coming out from Chinese Filipino LGBT people who had experienced the process of doing so, a phenomenological study was most suited.

This study aimed to explain and understand the reasons and consequences of choosing to come out as told by Chinese Filipino LGBT people. It was a narrative research that analyzes stories to understand people, including their cultures and histories (Wolgemuth & Agosto, 2019). Furthermore, it aimed to fill the gap of knowledge in gender studies focused on Chinese Filipino contexts.

2.2 Data Gathering Procedures

First, the researcher constructed several guide questions for the unstructured interviews to obtain the study's necessary data. The researcher reached out to self-identified Chinese Filipino LGBT respondents who were willing to be interviewed. The interviews were scheduled during a time available for the respondents. The interviews were conducted one on one. The researcher commenced the interview by asking the respondents to tell their story of coming out and asking probing questions when necessary. The transcript of the interviews was analyzed using critical discourse analysis.



3. RESULTS AND DISCUSSION

Through interviews with the eight respondents, the research showed the overarching themes present in their coming out experiences. These interviews aimed to give insight into how and to whom the respondents came out, their hesitations in coming out, the significant people's reactions in their lives, and their current relationship with these significant people. The study found the circumstances of each participant's coming out to be different and unique, but also showed commonalities among the narratives.

3.1 Hesitations in Coming Out

Each respondent's coming out experience was different, with different approaches to disclosing their identities as LGBT. Four respondents were out to everyone around them, including friends and family. Two respondents were out to some of their family and friends, while the remaining two respondents were only out to their friends, not at all out to their family.

All respondents felt hesitation or fear in coming out to their family and parents in particular, and for two respondents, this has kept them from coming out to their families. Respondents whose families were more traditional and conservative tended to be more hesitant in coming out. However, despite these hesitations, some still chose to come out to their families. One such case came out to her first-generation Chinese parents despite knowing they would react negatively. She said that it would be better for her parents to hear it from her rather than from someone else, and placed importance on the act of coming out itself.

Another common theme was coming out of their own volition. Respondents preferred to personally let significant people in their lives know about them being LGBT rather than let them hear it from an outside source, and the people they did not wish to come out to were not to be told unless by the respondents themselves. One respondent expressed active dislike for their sexual orientation being disclosed outside their consent. The agency of being the ones to express their sexuality was important to the respondents. Respondents who already came out to their families said they were more open to coming out to others.

No respondent was out only to their family and not to their friends, suggesting that this is less common than vice versa. This could be explained by the LGBT individuals perceiving fewer expectations from their friends than their family, and familial expectations, especially in Chinese Filipino contexts, are significant barriers to overcome in coming out. Parents, in particular, were family members who are

hardest to come out to, possibly due to their children's expectations and the inherent power they have over them.

Respondents also faced negative perceptions of the LGBT community before coming out, somewhat straining their relationships with the significant people in their lives. Some respondents considered themselves to be homophobic during this time, which they attributed to their more conservative Chinese Filipino environment growing up, such as their schools and their homes. This internalized homophobia may also have been one barrier to their coming out.

3.2 Positive and Negative Reactions

The reactions of the significant people in the lives of the respondents were generally positive. The results found that the respondents' friends reacted more positively to their coming out and were more outwardly accepting and supportive than their family.

Reactions from family were more mixed. Of the five respondents who came out to both parents, two had very accepting parents, while two had parents who were more hesitant to accept and support the respondents' coming out fully. Some families had very negative responses, and one respondent stated that her parents called her decision to come out 'selfish'. Fears of rejection led some of the respondents to not only not come out, but also actively hide their sexual orientation.

These reactions were usually expected by the respondents. One respondent stated that she expected her parents to think it was abnormal because their upbringing led them to believe it was a sort of disease. Another respondent stated that, though she thought her mother would be accepting, she still hesitated to come out to her, pointing to the trend of parents being the greatest obstacle in coming out.

Some people outside of friends and family also had strong reactions to the respondent's coming out despite not being significant people in their lives. These reactions were significant enough to the respondents to be brought up throughout the interview.

3.3 Shift in Relationship Dynamics

The relationships of the respondents with their friends and family they came out to did not change or they even became closer. Respondents stated that they could trust their friends and family more after coming out to them. They became more comfortable with their friends and vice versa, and felt that it was easier to approach people because they didn't feel the need to hide parts of themselves anymore.



One respondent expressed that she became more comfortable as herself around her parents, despite their non-acceptance of her sexual orientation. Her decision to verbalize her sexuality to them solidified her identity, and she said that she appreciated being able to make jokes about it around her mother and becoming closer with her sister.

Trust played a significant role in the coming out narratives of each respondent, and the trust they had in the people around them also affected their decision on whether to come out or not. After coming out to significant people, their trust increased or decreased depending on their reactions, and there was more avenue to be more open with others.

Many of the significant people in the lives of the respondents, particularly their friends, also did not have much knowledge of the LGBT community. Respondents explained concepts to these people, after which they became more educated on LGBT topics and issues, and became more accepting and supportive allies of the community.

Respondents stated that, during the time of their parents, LGBT issues were less prominent and less mainstream. One respondent also stated that, due to her schoolmates' more conservative Chinese upbringing, they were less informed about issues concerning the LGBTQIA+ community, therefore needed to be educated on them. Another respondent stated that, since her parents were from China, they had no knowledge of anything concerning LGBT issues.

4. CONCLUSIONS

This research highlighted the different experiences that each respondent underwent, the shared experiences of the respondents in their journeys, and comes to the following conclusions:

First, each person's journey in coming out is different. Each story is unique, due to different factors like their home and work environments, the people around them, and their environments while growing up. The process of coming out is a process of choices. Individuals choose to come out personally or choose to let the truth come out by itself. They choose to wait for a long time before coming out or choose to do it immediately after discovering that they are LGBT. Differences in past experiences and environments lead to differences in stories of coming out.

Second, while diverse, these experiences have commonalities that are constant through most, if not all, narratives. Most participants in the study came out first to friends before family, but not vice versa. They expressed hesitation and reluctance before coming out, especially to parents and other family members. Family is often the last and most complex

group of people to come out to, especially for Chinese Filipino families with more traditional beliefs and expectations that the individuals may push themselves to meet. Additionally, self-disclosure was very important for the participants, and it was important for them to come out personally to their friends and family.

Third, acceptance in coming out has generally positive results for the LGBT individuals who are coming out. All the respondents stated that coming out has improved their relationship with the people whom they came out to who accepted them. Individuals who came out became more open and trusting with the significant people in their lives. As the respondents who were accepted by their friends and families found positive results after coming out, acceptance may play a key factor in having positive outcomes after coming out.

5. ACKNOWLEDGMENTS

The researcher would like to thank her research adviser, Mr. Roberto P. Lim Jr., for the guidance in improving and polishing this paper, her validator, Mr. Raymond Robert Santos, for giving his time and sharing his expertise to ensure the strength of her research tools, to her respondents, for being accommodating by taking time from their schedules to sit and share their experiences, Dr. Richard Chu, for answering her questions and aiding her in strengthening her study, her family, for sharing their love throughout the research process and for being her pillars of support, and God, the Almighty for granting her the courage and the wisdom to conduct this study.

6. REFERENCES

- American Psychological Association. (2008). *Answers to Your Questions For a Better Understanding of Sexual Orientation & Homosexuality*. [Brochure]. <https://www.apa.org/topics/lgbtq/orientation.pdf>
- _____. (2011). *Answers to Your Questions About Transgender People, Gender Identity, and Gender Expression*. [Brochure]. <https://www.apa.org/topics/lgbtq/transgender.pdf>
- Aultman, B. L. (2019, July). *Nonbinary Trans Identities*. Retrieved from [10.1093/acrefore/9780190228637.013.1195](https://doi.org/10.1093/acrefore/9780190228637.013.1195)
- Baytan, R. (2000). Sexuality, ethnicity and language: exploring Chinese Filipino male homosexual identity. *Culture, Health & Sexuality: An International Journal for Research, Intervention and Care*, 2(4), 391-404.



- Brumbaugh-Johnson, S., & Hull, K. (2018). Coming Out as Transgender: Navigating the Social Implications of a Transgender Identity. *Journal of Homosexuality*.
- Chu, R. (2015). The "Chinese" and "Mestizos" of the Philippines. In *More Tsinoy Than We Admit: Chinese-Filipino Interactions Over the Centuries* (pp. 215-59). Vibal Foundation Inc.
- _____. (2020). Growing Up Male, Chinese, and Catholic in the Philippines and the Son My Mother Wanted Me to Be. In *More Tomboy, More Bakla Than We Admit: Insights into Sexual and Gender Diversity in Philippine Culture, History, and Politics* (pp. 399-418). Vibal Foundation.
- Creswell, J. (2007). *Qualitative Inquiry & Research Design*.
- Gonzales, W. D. (2018). Philippine Hybrid Hokkien as a postcolonial mixed language: Evidence from nominal derivational affixation mixing. National University of Singapore.
- Groenewald, T. (2004). A Phenomenological Research Design Illustrated. *International Journal of Qualitative Methods*, 3(1).
- Hau, C. (2014). *The Chinese Question: Ethnicity, Nation, and Region in and beyond the Philippines*. Ateneo de Manila University.
- _____. (2015). Conditions of Visibility: Resignifying the "Chinese"/"Filipino" in *Mano Po and Crying Ladies*. In *More Tsinoy Than We Admit: Chinese-Filipino Interactions Over the Centuries* (pp. 387-421). Vibal Foundation Inc.
- Heatherington, L., & Lavner, J. (2008). Coming to Terms With Coming Out: Review and Recommendations for Family Systems-Focused Research. *Journal of Family Psychology*, 22(3), 329-43.
- HRW. (2017). "Just Let Us Be" Discrimination Against LGBT Students in the Philippines.
- Huang, S., & Brouwer, D. (2018). Coming out, coming home, coming with: Models of queer sexuality in contemporary China. *Journal of International and Intercultural Communication*.
- Jiang, S. (2020, August 17). 'End of the Rainbow': Shanghai Pride shuts down amid shrinking space for China's LGBTQ community. CNN.
- Kornak, J. (2015). Judith Butler's Queer Conceptual Politics. *Redescriptions*, 18(1).
- Langbid, R., & Ngo, M. A. (2016). A Glimpse into the Anatomy of the Tribulations and Successes of the Chinese-Filipino in Lanao del Norte, Philippines. *IAFOR Journal of the Social Sciences*, 2(2).
- McLeod, S. (2014). *The Interview Research Method*.
- Miclat, M. (2000). Tradition, Misconception, and Contribution: Chinese Influences in Philippine Culture. *Humanities Diliman*, 1(2).
- Nassaji, H. (2015). Qualitative and descriptive research: Data type versus data analysis. *Language Teaching Research*, 19(2), 129-32.
- Newbauer, B., Witkop, C., & Varpio, L. (2019). How phenomenology can help us learn from the experiences of others. *Perspect Med Educ*.
- Palinkas, L., Horwitz, S., Green, C., Wisdom, J., Duan, N., & Hoagwood, K. (2015). Purposeful sampling for qualitative data collection and analysis in mixed method implementation research. *Adm Policy Ment Health*, 42(5), 533-44.
- Poudel, A. N., & Tang, X. (2018). Exploring challenges and problems faced by LGBT students in Philippines: A qualitative study. *Journal of Public Health Policy and Planning*, 2(3).
- Price, E. (n.d.). LGBT sexualities in social care research. NIHR School for Social Care Research Methods Review.
- Reuters Staff. (2021, February 26). Chinese court backs publisher of textbook calling homosexuality 'psychological disorder'. Hong Kong: Reuters.
- Rhoads, R. (1995). Learning From the Coming-Out Experiences of College Males. *Journal of College Student Development*.
- Ryan, W., Legate, N., & Weinstein, N. (2015). Coming Out as Lesbian, Gay, or Bisexual: The Lasting Impact of Initial Disclosure Experiences. *Self and Identity*.
- Schneider, F. (2013, May 13). How to Do a Discourse Analysis.
- See, T. A. (2005). Chinese in the Philippines. *Chinese in the Philippines*.
- _____. (2013). Chinese in the Philippines: Problems & Perspectives. KAISA Para Sa Kaunlaran.
- Shaw, I., & Holland, S. (2014). *Doing Qualitative Research in Social Work*. Sage Publications Ltd.
- Sedgwick, E. K. (1990). *Epistemology of the Closet*. University of California Press.
- Showkat, N., & Parveen, H. (2017, July). Non-Probability and Probability Sampling.
- Stonewall. (2018). STONEWALL GLOBAL WORKPLACE BRIEFINGS 2018: THE PHILIPPINES.
- Sujana, I. N., Setyawati, A. K., & Ujanti, N. M. (2018). The Existence of the Lesbian, Gay, Bisexual and Transgender (LGBT) Community in the Perspective of a State Based on Pancasila. Faculty of Law Universitas Gadjah Mada.
- UNDP. (2016). Being LGBTI in China – A National Survey on Social Attitudes towards Sexual Orientation, Gender Identity and Gender Expression.
- UNDP, USAID. (2014). Being LGBT in Asia: The Philippines Country Report. Bangkok.
- UNESCO. (2019). *LGBTQ2+ Inclusiveness: Toolkit for Inclusive Municipalities in Canada and Beyond*.
- Wang, Y., Hu, Z., Peng, K., Rechdan, J., Yang, Y., Wu, L., Xin, Y., Lin, J., Duan, Z., Zhu, X., Feng, Y., Chen, S., Ou, J., Chen, R. (2020, May 12). Mapping out a spectrum of the Chinese public's discrimination toward the LGBT community: results from a national survey. *BMC Public Health*, 20(1).
- Wickberg, E. (1964). The Chinese Mestizo in Philippine History. *The Journal Southeast Asian History*, 5(1), 62-100.
- Wolgemuth, J., & Agosto, V. (2019, May). Narrative Research.



“I saw the sign”: Extent of Use of Filipino Sign Language and its Impact on Interpersonal Relationships in the Workplace among Deaf employees

Naomi Chyla G. Choo, Yves Alvin Andrei A. Jimenez, Kentaro E. Kojima,
and Rommielle T. Morada

De La Salle University Integrated School, Manila

Abstract: In recent years, there has been an increase in employment opportunities available to persons with disabilities. Despite this, stigma surrounding the employment of the Deaf community in particular remains, causing higher unemployment rates as many employers show a preference for those with motor disabilities. Socialization is often the cited reason for this. Deaf employees face several communication barriers, such as the lack of a common linguistic background with their co-workers, as the former is limited to manual communication while the latter uses verbal. To overcome this barrier, some workplaces utilize Filipino Sign Language (FSL) to facilitate effective communication between Deaf and hearing co-workers. This study aimed to determine the impact of the Extent of FSL Use on the Quality of Interpersonal Relationships in the workplace, along with the Personal and Work-Related Characteristics generally affecting FSL Use. Through the use of a self-administered questionnaire and purposive sampling limited to Deaf employees, a positive correlation was found between the Extent of FSL Use and the Deaf employees’ perception of the Quality of Interpersonal Relationships with hearing colleagues. Factors such as Nature of Work, Educational Attainment, Industry, Network, and Organizational Size were also found to influence the Extent of FSL Use in the workplace.

Key Words: Filipino Sign Language; Deaf; PWD employment; workplace interpersonal relationships; workplace dynamics

1. INTRODUCTION

Due to the lack of readily available facilitation of interpreters, several complications arise for many Deaf workers, including but not limited to a lack of occupational prospects, innovative accommodations, employee retention, and salary increases (Guno, 2019; Mina, 2013). Existing literature has shown that these issues stem from the multiple communicative challenges Deaf employees face in day-to-day operations (Cruz & Calimpusan, 2018; Guno, 2019; Lamichhane, 2015; Mina, 2013; Svinndal et al., 2019). Because of the lack of communicative spaces for them in several areas of their work-life, most display low social participation in work-related social functions, leading to social withdrawal, difficulty in establishing rapport, reluctance in asking for accommodation, and feelings of being undervalued as an employee (Punch et al., 2007; Svinndal et al., 2019; Wells et al., 2009). As third-party mediators such as translators only relay information to them, there is little to no space for them to participate in meetings, casual conversations, training functions, etc., rendering them unable to provide incidental input and to fully participate in workplace interactions, both integral to

the perceived self-importance of the disabled employee in the workplace (Wells et al., 2009).

As such, Deaf employees have been found to prefer communicating with their hearing co-workers in signed language directly, as it was “more comprehensible” and “easier” in terms of working with employees who understood the same language (Mina, 2013; Wells et al., 2009). Today, Filipino Sign Language (FSL) exists as the Philippines’ national sign language institutionalized in Deaf culture, as it is “able to capture the idiosyncrasies of how Filipinos talk” (Filipino Sign Language Act 2018; Imperial, 2015). Though related literature is scarce, the use of FSL in the workplace and the overall involvement of the Deaf community as members of the workforce may be attributed to the following factors: Personal Characteristics such as their biological sex, educational attainment, alma mater (whether or not they were enrolled under a Special Education school), and their nature of work (Goertz et al., 2010; Kim, 2006; Lamichhane, 2015; Martz & Xu, 2008; Smith, 2007; Williams et al., 2006); as well as Work-related Characteristics such as their industry, company policy and advocacies, membership in a network, and the number of co-workers with similar disabilities (Foster



& MacLeod, 2003; Gatchalian et al., 2014; Graffam et al., 2002; Honey et al., 1993; Mansour, 2009).

According to a study by Wells et al. (2009), the quality of participation that Deaf employees experienced in their work environment directly affected their perception of interpersonal relationships. A high perception of the quality of interpersonal relationships directly impacts employees' behavior, especially regarding their ability to collaborate, commitment to their responsibilities, their overall performance, and internal and external organizational communication, among others (Szostek, 2019). Developing a common language employed internally within a social group involves the passive acquisition of communicative practices through association with a community, demonstrating internal identification, and, therefore, positive interpersonal relationships (Durrel, 2004). In line with this, Cohen and Kassis-Henderson (2012) reported that the use of language is of great importance when establishing rapport with multilingual co-workers. Though Cohen and Kassis-Henderson's observation was made about spoken languages, the general idea remains the same — provided a company's employees' desire to bridge the communication gap, their use and reception of FSL from their Deaf colleagues must be thoroughly studied, together with its effect on their workplace interactions and resulting perceived interpersonal relationships.

1.1 Research Objectives

Specifically, this study seeks to answer the following research questions:

1. To what extent do Deaf workers use FSL in the workplace?
2. What is their perceived Quality of Interpersonal Relationships in the workplace?
3. How does the Extent of FSL Use impact their perceived Quality of Interpersonal Relationships?
4. What is the relationship between the Personal and Work-related Characteristics of Deaf employees and the extent to which they use FSL in the workplace?

1.2 Conceptual Framework

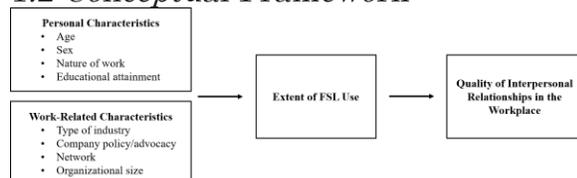

Figure 1. Conceptual Framework

This study focuses on the extent to which FSL is used in workplaces with Deaf employees in different industries and its effect on their perceived quality of interpersonal relationships within said environment.

There are three independent variables in this study, namely (1) Personal Characteristics, (2) Work-related Characteristics, and (3) the Extent of FSL Use in the workplace among Deaf employees. The primary dependent variable of this study is the Quality of Interpersonal Relationships in the workplace. The Extent of FSL Use in the workplace is affected by the outlined Personal and Work-related Characteristics. 'Extent' in this variable refers to both the frequency and variety of interactions where Deaf employees utilize FSL.

This can then affect interpersonal relationships within the work environment. Given that spoken language plays a vital role in establishing rapport among multilingual workplaces (Cohen & Kassis-Henderson, 2012), there is reason to believe that this effect is present among sign language users as well, if not more significant.

2. METHODOLOGY

In line with the enumerated research questions, the study utilized a descriptive and explanatory research design. A purposive sampling technique was used, and respondents were chosen based on the following criteria: they 1) must be entirely deaf and 2) must be employed. The researchers tapped personal connections, contacted various organizations, and crowdsourced on social media for potential participants.

The instrument used to gather data was a self-administered questionnaire using Google forms. The questionnaire consisted of four sections: sections one and two were designed to catalog the respondents' Personal (e.g., age, sex, nature of work) and Work-related (e.g., type of industry, organizational size) Characteristics, respectively. Section three utilized a 7-point Likert scale with questions to ascertain the Extent of FSL Use in the workplace. With 1 being low and 7 being high, respondents were asked to rate their ability to communicate with co-workers using FSL in everyday workplace situations, such as supervision, meetings, and spontaneous interactions. This was adapted from a similar study by Punch et al. (2007), modified to fit the present paper's nuances. Section four used a 4-point Likert scale to examine the Quality of Interpersonal Relationships the respondents had with their co-workers. Questions in this section were adapted from Szostek's (2019) study and operationalization of the determinants of the Quality of Interpersonal Relationships. A simplified version of the Informed Consent Form was appended to the Google Form. The entire questionnaire is in English



but included Filipino translations for the convenience of the respondents.

The following statistical tests were used in the study:

Table 1. Data analysis matrix.

Independent Variables	Type of Data	Dependent Variable	Type of Data	Statistical Test
Personal Characteristics:				
- Age	Ratio	Extent of FSL Use	Interval	Spearman's Rho t-Test
- Sex	Nominal			
- Nature of work done	Ordinal			Descriptive
- Educational Attainment	Ordinal			
Work-related Characteristics:				
- Industry	Nominal	Extent of FSL Use	Interval	Descriptive
- Company policy/advocacy	Nominal			
- Network	Nominal			Mann-Whitney One-way ANOVA
- Organizational Size	Interval			
Extent of FSL Use	Interval	Quality of Interpersonal Relationships	Interval	Spearman's Rho

3. RESULTS AND DISCUSSION

3.1 Characteristics Affecting Extent of FSL Use

The Personal and Work-related Characteristics which showed a statistically significant effect on the Extent of FSL Use are Network and Organizational Size, while notable trends were observed for the Nature of Work, Educational Attainment, and Industry. For the remaining independent variables, Age, Sex, and Company Policy/Advocacy, the researchers could not gather sufficient evidence to declare that they affected the dependent variable significantly.

Table 2. Extent of FSL Use by Presence of Network

Network of PWD Organizations	n	Extent of FSL Use Score	
		M	SD
Present	48	37.85	12.65
Not Present	6	21.33	6.77

The Mann-Whitney U Test conducted to establish a relationship between Extent of FSL Use and companies' coordination with PWD groups (presence of a Network) yielded a p-value of 0.0019 ($\alpha = 0.05$). There is enough evidence to conclude that being part of a network directly increases the Extent of FSL Use. The result confirms previous studies (Cruz & Calimpusan, 2018), which observe that

forming relationships and connections with the larger Deaf community through the aforementioned networks is essential for Deaf workers to receive social, economic, financial, emotional, and other forms of support in both their jobs and personal lives. It allows them to be more engaged with like-minded individuals who are more likely to take actions towards inclusivity, including supporting the use of FSL across various platforms.

Table 3. Extent of FSL Use by Organizational Size

Organizational Size (No. of Deaf employees)	n	Extent of FSL Use Score	
		M	SD
1-15	23	30.00	13.32
16-30	19	37.74	11.79
Above 30	12	44.83	9.45

Likewise, a one-way ANOVA test conducted to draw a relationship between the Extent of FSL Use and the organizational size of a company yielded a p-value of 0.0036 ($\alpha = 0.05$), indicating a significant difference in the Extent of FSL Use between companies that house 1 to 15, 16 to 30, and more than 30 Deaf employees. This suggests a linear relationship between a company's Organizational Size and the Extent of FSL Use, confirming Foster and MacLeod's (2003) findings that few Deaf co-workers are likely to lead to a smaller Extent of FSL Use due to isolation and discouragement.

For the variables in which trends in the data were observed, namely Nature of Work, Educational Attainment, and Industry, the researchers were only able to utilize descriptive statistics instead of the planned statistical tests due to the insufficient number of respondents for specific categories.

Table 4. Extent of FSL Use by Nature of Work Done

Nature	n	Extent of FSL Use Score	
		M	SD
Vocational	13	28.08	13.23
Rank and file/Clerical	28	36.04	13.14
Supervisory	6	46.50	8.87
Managerial	6	42.83	7.73
Executive	1	35.00	N/A

Regarding Nature of Work, supervisory and managerial showed the highest mean score in the Extent of FSL Use, compared to employees in lower job levels such as vocational. Excluding the executive level that garnered only one respondent, thus being an unreliable value, this trend may be explained by the greater likelihood of employees with higher job levels requesting additional workplace accommodations from accumulating years of experience (Punch, 2016).



Additionally, the distribution of labor in supervisory and managerial positions may mean that they have more resources to dedicate to promoting FSL among their co-workers than those with labor-intensive physical occupations.

Table 5. *Extent of FSL Use by Educational Attainment*

Educational Attainment	n	Extent of FSL Use Score	
		M	SD
Elementary	2	24.50	3.54
High School	9	30.11	13.87
College	37	37.38	13.48
Vocational	3	36.67	8.62
Post-Graduate	3	44.00	7.94

The respondents were also asked regarding their educational background. Employees with post-secondary educational attainment, such as college and vocational degree holders, report higher average use of FSL because they are more likely to request and receive additional workplace accommodations compared to those with elementary or secondary education (Punch, 2016). This may be because PWD employees with lower educational attainment can be assigned to lower positions, which companies usually prefer (Kim, 2006). This allows employers to save money that would otherwise have been invested in training, supervision, and other related expenses, negatively affecting FSL usage.

Table 6. *Extent of FSL Use by Industry*

Type of Industry	n	Extent of FSL Use Score	
		M	SD
Creative	5	44.40	13.15
Education	4	39.25	17.46
Food Service	9	27.22	11.19
Manufacturing	8	28.38	12.36
Professional Services	24	40.83	11.64
Retail	2	30.50	7.78
Utilities	2	26.50	0.71

Results show that Extent of FSL Use varied greatly across industries: workers in the utilities and foodservice sectors rated their usage of FSL the lowest. In contrast, the creative industry had the highest reported Extent of FSL Use, followed by the professional services and education industries. The nuances of communication across various industries and differing job requirements may explain this discrepancy. The industries which scored lower could require less communication among employees in general. Those in the utilities industry, for example,

may be required to do work with minimal interaction with co-workers, making FSL use low regardless of other factors such as the number of PWD peers. In contrast, FSL may be more widely utilized in different fields, which require employees to communicate more with others. This is especially true for the education industry, which gives more opportunities for Deaf teachers to converse in FSL with both Deaf and hearing co-workers and students.

As for the characteristics which did not show significant effects or specific trends, they may not be as relevant to the usage of FSL as compared to other factors. A Spearman's Rho test to measure the linear relationship between Age and Extent of FSL Use scores returned a p-value of 0.8346 ($\alpha = 0.05$). A t-Test for independent samples test to compare the mean scores of male and female categories showed insignificant difference ($p = 0.8932$). Lastly, the effect of the presence of company advocacy was tested through a Mann-Whitney U Test, though this again proved insignificant ($p = 0.45$). However, it is also possible that their impacts are simply not observable because of the small sample size in some categories. The study was not able to gather enough evidence to conclude that advocacy has a significant effect on the Extent of FSL Use, but further research is still needed to confirm the findings.

3.2 Extent of FSL Use and Quality of Interpersonal Relationships

Each respondent's scores for Extent of FSL Use and Quality of Interpersonal Relationships were treated as interval values, obtained by calculating the sum for their respective sections in the questionnaire.

The resulting data from both variables suggests a positive correlation. To confirm this finding, Spearman's Rho correlation coefficient was used to test for nonparametric correlations. The test revealed a moderately positive correlation coefficient, and a statistically significant relationship between the two variables, $r_s [52] = 0.45, p < 0.001 (\alpha = 0.05)$. The researchers thus conclude that a larger Extent of FSL Use within the workplace improves the quality of Deaf employees' perceived interpersonal relationships with their co-workers.

In line with related literature, the quality of participation that Deaf employees are granted within their workplace directly affects their perceived Quality of Interpersonal Relationships (Wells, 2009). This participation may be illustrated as the extent to which they are able to communicate with their colleagues, particularly for incidental conversation, interaction, and information (Foster and MacLeod, 2003), something that is encouraged by their use of FSL as the primary medium. An increased perception of the quality of one's interpersonal relationships with



their co-workers has been found by existing literature to foster learning processes in organizations, positively affect employees' psychological safety, and decrease counterproductive work behavior (Carmeli et al., 2009; Szostek, 2019). In this sense, an increase in the extent to which FSL contributes to those effects as well.

4. CONCLUSIONS

It must be noted that given the limited number of respondents and the skewed nature of a few categories in the data set, these results are not meant to generalize the Deaf population. Instead, these are intended to raise awareness on the issue of employment and occupational accommodations for the Deaf community and to instigate further research efforts. With that said, the following characteristics displayed statistically significant effects on the Extent of FSL Use: the Nature of Work, Educational Attainment, Industry, Network, and Organizational Size. Oppositely, the following factors displayed insignificant effects: Age, Sex, and Company Policy/Advocacy. Meanwhile, the Extent of FSL Use has been confirmed to have a significant positive correlation with Quality of Interpersonal Relationships in the workplace. By extension, the aforementioned characteristics also directly impact the dependent variable. The analysis of the survey results shows the importance of proper allocation of resources and responsibilities to Deaf individuals that match their personal and work-related assets, along with initiative from their hearing peers to cultivate a healthy work environment. These findings may guide employers and the larger Deaf community alike to determine which factors should be focused on to ensure inclusive practices in the workplace, which are still insufficient for Deaf workers.

5. ACKNOWLEDGMENTS

The researchers would like to express their sincere gratitude to their research adviser, Dr. Melvin A. Jabar from the Behavioral Sciences Department, for his guidance and patience throughout the study. Likewise, to their research mentor, Ms. Omega Diadem Danganan, who has taught them valuable information and techniques in practical research.

Moreover, special thanks are in order to the following key contacts: Miss Bernadette Infanta, Rowena Jimenez, Marc Peñaredondo, Lucilina Castillo, Ar. Mary Grace L. Gonzales, and Ronezes Rivera. Their advice and connections to the Deaf

community were essential in the completion of this project.

Additionally, the researchers would like to recognize and extend gratitude to the following organizations for their assistance in the dissemination of the survey questionnaire: Metro Manila Development Authority, Project Inclusion Network, FSLTreasure, the National Council on Disability Affairs, the Department of Labor and Employment, and the Department of Foreign Affairs.

The researchers are also grateful for the unwavering support of their friends and families. Last but not the least, they would also like to thank De La Salle University for the opportunity and resources available.

6. REFERENCES

- Carmeli, A., Brueller, D., & Dutton, J. E. (2009). Learning behaviours in the workplace: The role of high-quality interpersonal relationships and psychological safety. *Systems Research and Behavioral Science*, 26(1), 81–98. <https://doi.org/10.1002/sres.932>
- Cohen, L., & Kassis-Henderson, J. (2012). Language use in establishing rapport and building relations: Implications for international teams and management education. *Management & Avenir*, 22, 185 - 2017.
- Cruz, F. W. S. D., & Calimpusan, E. C. (2018). Status and challenges of the deaf in one city in the Philippines: towards the development of support systems and socio-economic opportunities. *Asia Pacific Journal of Multidisciplinary Research*, 6(2), 61-74.
- Durrell, M. (2004). Sociolect. In U. Ammon, N. Dittmar, & K. J. Mattheier. (eds.), *Sociolinguistics. An International Handbook of the Science of Language and Society*. Walter de Gruyter. pp. 200–205.
- Foster, S., & MacLeod, J. (2003). Deaf people at work: Assessment of communication among deaf and hearing persons in work settings. *International journal of audiology*, 42, S128-S139.
- Gatchalian, E., Bulahao, J., Boyayao, F., Cataina, M., Cumilang, J., Dulnian, J., & Salaguban, P. (2014). Dimensions of Filipino employers' attitudes in hiring Persons with Disability. *Philippine Journal of Psychology*, 47(2), 27-64.
- Graffam, J., Shinkfield, A., Smith, K., & Polzin, U. (2002). Factors that influence employer decisions in hiring and retaining an employee with a disability. *Journal of Vocational Rehabilitation*, 17(3), 175- 181.



- Goertz, Y., van Lierop, B., Houkes, I., & Nijhuis, F. (2010). Factors related to the employment of visually impaired persons: A systematic literature review. *Journal of Visual Impairment & Blindness*, 404-418.
- Guno, N. (2019). How the Deaf deal: Finding work and working to be heard. *Philippine Inquirer*. <https://newsinfo.inquirer.net/1198478/how-the-deaf-deal-finding-work-and-working-to-be-heard>.
- Honey, S., Meager, N., & Williams, M. (1993). *Employers' Attitudes Towards Disabled people*. IMS.
- Imperial, M. (2015). Kinds of sign language in the Philippines. <https://verafiles.org/articles/kinds-sign-language-philippines>.
- Kim, P. S. (2006). An analysis of the employment of persons with disabilities in the Korean government: A comparative study with the American federal government. *Public Personnel Management*, 35(1), 15-31.
- Lamichhane, K. (2015). *Disability, Education and Employment in Developing Countries*. Cambridge University Press.
- Mansour, M. (2009). Employers' attitudes and concerns about the employment of disabled people. *Proceedings of the Asia-Pacific Business Research Conference* (pp. 1-11). World Business Institute. www.wbiconpro.com/index.html
- Martz, E., & Xu, Y. J. (2008). Person-related and service-related factors predicting employment of individuals with disabilities. *Journal of vocational rehabilitation*, 28(2), 97-104.
- Mina, C. D. (2013). *Employment of persons with disabilities (PWDs) in the Philippines: The case of Metro Manila and Rosario, Batangas*. PIDS Discussion Paper Series.
- Punch, R. (2016). Employment and adults who are deaf or hard of hearing: Current status and experiences of barriers, accommodations, and stress in the workplace. *American annals of the deaf*, 161(3), 384-397.
- Punch, R., Hyde, M., & Power, D. (2007). Career and workplace experiences of Australian university graduates who are deaf or hard of hearing. *Journal of Deaf Studies and Deaf Education*, 12(4), 504-517.
- Smith, D. L. (2007). The relationship of type of disability and employment status in the United States from the behavioral risk factor surveillance system. *Journal of Rehabilitation*, 73(2), 32.
- Svinndal, E. V., Jensen, C., & Rise, M. B. (2019). Employees with hearing impairment. A qualitative study exploring managers' experiences. *Disability and Rehabilitation*, 42(13), 1855-1862. <https://doi.org/10.1080/09638288.2018.1541101>
- Szostek, D. (2019). The impact of the quality of interpersonal relationships between employees on counterproductive work behavior: A study of employees in Poland. *Sustainability*, 11(21), 5916. <https://doi.org/10.3390/su11215916>
- The Filipino Sign Language Act, R.A. 11106, 17th Cong. (2018) (enacted).
- Wells, A. G., Bhattacharya, K., & Morgan, D. D. (2009). "DEAF WORLD, THAT'S WHERE I'M AT": CAMARADERIE BETWEEN AND HEARING EMPLOYEES. *Journal of Ethnographic & Qualitative Research*, 3(2).
- Williams, M., Sabata, D., & Zolna, J. (2006). User needs evaluation of workplace accommodations. *Work*, 27, 355-362.



Lived Experiences of Filipinas in Adhering to the Beauty Standards in TikTok

Beatrice Nasharette B. Bambao, Bianca Adrienne C. Carilla,
Darren Cian G. Navarro, Jalwinder Kate G. Mariano, Lovely Anne B. Garcia,
Sebastian Andrei N. Frigillana, and Trina Franzell G. Puapo
LORMA Colleges Senior High School, San Juan, La Union

Abstract: Deeply rooted in a Filipina's grip of oneself was the reflection of what her detractors claim to know about her. However, as she had grown to know better, her reigning beauty eventually became the fairest of them all. Since ancient history, society has always been obsessed with beauty. Today, people's desire to leap onto the fountain of youth is still ubiquitous. Given the technological advancements present in the 21st century, a bigger pressure on beauty standards has been made where not many can make the cut without having to sacrifice their authentic beauty. This study aims to raise awareness about the misogyny faced by women in Tiktok; thus, to generate the perspective of each respondent, the researchers used phenomenological approach through the descriptive qualitative research design where an online interview has been conducted with fifteen Filipina Tiktokers of any niche whose follower count has, at least, a thousand. Through purposive sampling, this study elucidated the lived experiences of Filipina Tiktokers when adhering to the beauty standards imposed upon them. The data gathered were grouped thematically based on the theoretical framework and the general factors behind the respondents' answers. The study delved deeper into the interplay of societal impact, viewer feedback, self-assessment, and coping mechanisms when tackling the beauty standards that target these women. Furthermore, through the freedom wall blog, the researchers would now be able to set up an avenue as to where young girls and women can share their stories to inspire and empower others.

Key Words: beauty; beauty standards; Flipina, Tiktokers; Tiktok

1. INTRODUCTION

1.1. Background of the Study

Since ancient history, society has always been obsessed with beauty. Though beauty is something that cannot be standardized (Hummer, 2018), the feminine beauty ideal is “the socially constructed notion that physical attractiveness is one of women’s most important assets to achieve and maintain” (Schmoyer, 2018).

In the Philippines, there is a long history when it comes to its beauty standards considering the colonization it has gone through for 384 years. During those years, both American and Spanish cultures were clear that lighter complexions mean highly maintained social status causing Filipino's fascination for having fair skin to be considered beautiful. Given the geographical conditions in the Philippines, it is normal for the skin to produce melanin for protection from the sun's heat. However, considering how long it has been colonized by, mostly, western countries, the issue of colorism was and still is, very vivid to the Filipinos. Meanwhile, in the 21st Century, society's

definition of beauty catered to the petite and thin figures more than the curvy ones (Swami, 2016).

Having fair skin, a slim body, and a straight nose is the ideal beauty standard in the Philippines. Consequently, different beauty products such as whitening soaps were being bought by Filipinas to achieve these standards. Although morena beauty exists, these morenas usually have straight noses. Resulting in some women, celebrity or not, feeling the need to undergo cosmetic surgeries. Moreover, exercising and dieting were also done by Filipinas to achieve a slim fit body to feel like they belong in the society (Shimizu, 2016).

The emergence of technology created a huge impact on the people and history. Thus, social media has become a major part in the lives of people (Jan et al., 2017). Despite its advantages, risks such as cyber-harassing, hacking, and bad effects on health may also occur from time to time (Akmar & Kumar, 2018).

Looking into the skyrocketing popularity of TikTok in just a few years of its existence, the app has already become one of the most popular social media applications among people, especially for young adults, across the whole world (Jaffar et al., 2019). The



application was first introduced as Douyin by a company called ByteDance founded by Zhang Yiming in China in 2016 and was merged with Musical.ly and used the name "TikTok" in 2017 (Fannin, 2019). It then became the fourth most downloaded social app, surpassing Facebook, Instagram, and Youtube in the App Store in September 2019. In Google Play Store, it has a 4.6 rating, making this application highly qualified to merge Artificial Intelligence and image capture (Jaffar et al., 2019).

Like any other application, TikTok also has beauty filters that appear as a flawless beauty image causing countless young girls to lose themselves because of this demand to copy attractive ideals (Jain & Chanda, 2020). The underlying denominator found among TikTok challenges is the value judgment. This kind of context has contributed to the normalization of the female body's sexualization (Khattab, 2020). According to a recent study by Natarajan (2020), the hidden standards behind misleading creators on TikTok would eventually result in a generation of young adults who are insecure about their body image.

A teacher of digital social media at USC, Karen North, said that TikTok has developed so quickly and is so well known. "It has moreover been an app the bullies have utilized to insult youthful victims", she added. Though settings can be altered so children can only be reached by individuals they know, this still cannot fully guarantee their safety.

In the Philippines, an aspiring educator named Mia Franz Gelicka turned to Tiktok to educate and advocate women empowerment based on how she experienced colorism and body shaming. From the model's viral videos, she shuts down fat-shaming comments and toxic beauty standards wherein the post has over 68,000 likes and 376,000 views. Because of such issues in physical appearance, Tiktok launched the #BetterMeBetterInternet campaign in the Philippines where a quiz for proper knowledge for online safety and positive online habits was done.

The purpose of this research study is to raise awareness about the misogyny faced by women, which is indeed prevalent at this point in time. Furthermore, through the Freedom Wall Blog, the researchers would now be able to set up an avenue where young girls and women can share their stories to inspire others and to remind them that the world would be theirs for the taking. Gone should be the days of them existing merely just to impress and stun men.

1.2. Statement of Objectives

This study seeks to unravel the lived experiences of Filipina TikTokers when it comes to adhering to the beauty standards imposed upon them.

More specifically, this study aims to answer the following questions:

1. What are the lived experiences of Filipina Tiktokers

in adhering to the beauty standards set by TikTok?

2. What are the coping strategies being undertaken by Filipina Tiktokers in dealing with the imposed beauty standards upon them?

2. METHODOLOGY

2.1. Research Design

This research study utilized the descriptive qualitative research design with phenomenological approach as it focuses on the study of an individual's life and living experiences. Using this approach, the researchers were able to have deeper analysis regarding the experiences that Filipina Tiktokers encountered and determined reality from their experiences.

Furthermore, descriptive research design directs in defining the population's phenomenon systematically. With the use of this design, the experiences, views, and opinions of Filipina Tiktokers with regards to Tiktok having beauty standards were discovered.

2.2. Participants and Locale of the Study

In determining the respondents' suit for this study, the researchers used purposive sampling which is a non-probability sample that is selected based on characteristics of a population and the objective of the study. With the set criteria, the researchers were able to have fifteen (15) respondents.

2.2.1. Inclusion Criteria

This research study was inclusive of any Filipina TikToker whose follower count is not under a thousand (1,000). Their niche could be of any choice they became known for.

2.2.2 Exclusion Criteria

The data gathering excluded TikTokers who are not Filipinos, who are male (identity or expression), and whose follower count is lower than a thousand (1,000).

2.3. Data Gathering Tool

The researchers utilized the virtual space through floating online questionnaires which consist of a list of questions that are not limited in addressing a single aspect only.



2.4. Data Gathering Procedures and Ethical Consideration

A letter of approval was sent to the academic head and school director of LORMA Basic Education Schools and interview questions were validated by the validators. The researchers sent the letter of consent to the respondents before sending the questionnaires. Respondents' identities were also kept confidential.

2.5. Data Analysis

The gathered data were subjected to thematization for thorough analysis wherein it was organized based on how the respondents answered the given researcher-made questions during the conduct of the study

3. RESULTS AND DISCUSSION

The study acquired a total of fifteen (15) fully answered and useful responses which were considered for the in-depth analysis.

3.1 Societal Impact

As society shifts its needs from women time to time, the characteristics they hold also shapeshift into what society perceives as "beautiful" every now and then (Laitman, 2020). This impact or influences how people choose to live their lives from thereon.

Each respondent had a strong viewpoint when talking about the beauty standards imposed upon Filipina TikTokers at this point in time.

a. Inclusivity

Inclusivity is being included in a part of something bigger (Loeffler, 2016). In determining whether or not beauty standards are inclusive in Tiktok, the respondents were asked if they think that a set of beauty standards is only limited to a specific niche. According to all of the respondents, beauty ideals are not restricted to a particular niche. Their statements imply that whatever your niche is, you can and will be affected by it.

b. Self-Deprecation

The concept of self-deprecation is rooted in the portrayals of unrealistic imagery of beauty ideals which initiates body dissatisfaction amongst women especially to those who cannot attain the ideal (Foo, 2010). Thirteen (13) respondents have experienced feelings of self-consciousness during or after watching other content creators in TikTok. Moreover, the results of the study are supported by Higgin's (1987) Self Discrepancy Theory which states that individuals equate themselves to rationalized norms that are linked to different forms of "emotional vulnerabilities".

c. Stereotypical Destruction

Women of today are aiming more towards inclusivity when it comes to the different beauty types (Givhan & Morales, 2020). Though some respondents said that TikTok normalizes the stereotyped Filipina beauty, often resulting to body shaming, twelve (12) respondents shared their thoughts on how TikTok can educate people in loving their flaws and normalize other people's imperfections as to fit in the society's beauty standards without giving up your genetic beauty is "unrealistic" (Donati, 2017).

d. Nonconformism

Alongside social media's rise is the instantaneous reduction of individuality (Abbariki, 2018). In TikTok, users view the platform as a real-world community by conforming to particular norms (Yang, 2020). However, ten (10) respondents repudiate to conform to these as TikTok liberates young people to be creative without adhering to the visual styles, narratives, and online cultures of the past (Bresnick, 2019).

3.2 Viewer Feedback

Viewer feedback magnifies what types of feedback these Filipina TikTokers get from their viewers given that judgemental disability has been more rampant considering the century we currently are in (Lores, 2016).

a. Compliments

"You're really pretty", "You're a good dancer", and "You're very inspiring" are common complementary phrases Filipina TikTokers have been receiving from their viewers based on the data gathered. Compliments may be considered an act of kindness that has the potential to make us feel good about ourselves – whether we are the giver or the receiver of the compliment (Bedosky, 2018).

b. Imperfections

Having flaws are what caused three (3) of the respondents to receive criticisms from their viewers targeting issues of colorism and physical appearance. A respondent said, "someone said I look different without makeup" while another one received the comment, "you have dark skin like other Filipinas". As per Schreiner in 2017, the occurrence of such name-calling and/or bullying are caused by an "unconscious defense mechanism" making these bullies feel "superior" and/or "better" than the person whom they call out (Dean, 2020).



3.3 Self-Assessment

Past the judgments and criticisms these Filipina have encountered in TikTok, the essence of self-assessment is a process close to their roots as they always fear to lose their groundedness. Through the respondents' varied answers, Contentment, Self-Appreciation, and Natural Beauty are the sub-themes under this theme.

a. Contentment

According to Pearce in 2019, being satisfied and thankful with what you have, who you are, and where you are is what it means to be content even though a bit of desire is still existing. Thirteen (13) respondents do not consider themselves eligible for cosmetic surgery and are content with their present physical features.

b. Self-Appreciation

Self-appreciation is about consciously acknowledging the positive within you without the need to compare yourself to others (Razzetti, 2018). Seven (7) respondents answered that Tiktok boosts their confidence which fuels their appreciation for their beauty.

c. Natural Beauty

Natural beauty is defined as appearing attractive without the use of cosmetics. Teenagers with inner radiance, charming smiles, and natural elegance stand out (Kotamraju, 2018). The essentiality of beauty products for nine (9) respondents is low; claiming that beauty products are not necessary in Tiktok videos. Though people believe that women who wear lots of make-up have poor self-esteem, today's women are more into embracing flaws than ever. However, in some cases, cosmetic products are needed as TikTok itself has filters to enhance features, whiten complexion, and smoothen skin (Kupp, 2016).

3.4 Coping Mechanisms

Coping mechanisms tackle the adjustments made by the respondents in addressing the negative feedback from their viewers. Sub-themes of Self-Worth, Neglect, and Screen Time Reduction had been raised.

a. Self-Worth

Personal importance placed upon oneself is hugely dependent on self-worth (Hill, 2021). Considering that thirteen (13) of the respondents are not affected by people's feedback and do not take negativity to make them change their body image, there is a noticeable force of high self-worth within these empowered women. Women with high self-

worth tend to look past their mistakes and not let negative feedback be launched into an onslaught of heightened self-criticism (Kabir, 2016).

b. Neglect

It's impossible to evade criticism nowadays; there are simply too many review sites for you to keep anything quiet (Quacquarelli Symonds, 2019). When the respondents were asked how they cope with negative feedback, the majority answered "ignoring" while some answered to be optimistic, and some said to accept what is.

c. Screen Time Reduction

The importance of reducing screen time in using various types of technological devices is worthy as it is beneficial to your health (Slingshot Health, 2020). According to Consumer News and Business Channel in 2020, excessive screen time has been found to increase the risk of different illnesses. Nine (9) of the respondents answered that they are decreasing their screen time for their health and to avoid the loops of self-deprecation.

4. CONCLUSIONS

This research found out that the imposition of beauty standards among Filipinas may be inimical, but these empowered women are taking bigger steps in smashing stereotyped beauty standards one at a time. In addition, the relationship between the societal impact and the way these Filipina TikTokers see themselves was also distinguished. The change of direction these Filipina TikTokers wish to take to have a more inclusive definition of beauty was also highlighted through this study.

Given that these beauty standards had done more harm than good to the women of the past, now would be the time to best unshackle the chains of stereotyping because these "imperfections" are what also make these Filipinas a real Filipina. The researchers would also acknowledge that this paper has its own gaps and weak points; thus leaving these recommendations for future researchers to take into consideration:

1. Conduct personal interviews to allow more room for interaction.
2. Examine TikTokers with a smaller audience reach to assess whether or not the public would have more pressure onto those who do not tend to "fit" the imposed Beauty Standards among Filipinas in TikTok.
3. Consider the interactions that these TikTokers have with their followers to know if this leads them to change their personality traits or not.
4. Determine the effectiveness of TikTok videos that challenge pressing issues aimed toward women and



how such movements can be maintained and/or improved.

5. ACKNOWLEDGMENTS

This study is a clear manifestation that with hard work and encouragement from those who selflessly had, supported, and guided us, anything can be done. We acknowledge our parents for the utmost support they had given, be it physically or spiritually. To our research buddies who exchanged ideas with us, gave us suggestions, and made everything beyond possible for us. Without them, life would not be as thrilling and as exciting as it actually is; without them, being able to finish this study would surely just be a dream within a dream. To our research adviser, Ms. Antonette L. Ongangad, who was always there to lend us a helping hand just for us to be able to further improve our research paper and for letting us acquire new experiences regarding research, which we would definitely carry for the rest of our lives. To ourselves, for surviving and finishing this study together. We truly deserve a pat on the back. And lastly, To God and His angels, for always looking after us and gracing us with wisdom and knowledge that served as our pillar in completing this thesis. We are truly grateful to everyone who has given us all the best in every way they possibly ever could. We thank them more than words can say.

6. REFERENCES

- Abbariki, B. (2018, April 2). Social Media Increases Conformity. <https://cardinaltimes.org/12306/opinion/social-media-increases-conformity/>
- Akmar, W., & Kumar, R. (2017, October 30). A Study on Positive and Negative Effects of Social Media on Society. *International Journal of Computer Sciences and Engineering*, 5 (10), 347-354. <https://doi.org/10.26438/ijcse/v5i10.351354>
- Bedosky, R. (2018, April 11). The Psychology of Giving and Receiving Compliments. Sacred Heart University. <https://digitalcommons.sacredheart.edu/acadfest/2018/all/126>
- Bresnick, E. (2019, April 25). Intensified Play: Cinematic study of TikTok mobile app. https://www.researchgate.net/profile/Ethan-Bresnick/publication/335570557_Intensified_Play_Cinematic_study_of_TikTok_mobile_app/links/5dd3443d299bf1b74b4e2832/Intensified-Play-Cinematic-study-of-TikTok-mobile-app.pdf
- Consumer News and Business Channel. (2020, March 13) Why you should be reducing screen time and 3 simple ways to do it? Consumer News and Business Channel. <https://www.cnb.com/2020/03/13/why-you-should-be-reducing-screen-time-and-3-simple-tips-to-do-it.html>
- Dean, M. (2020, December 8). Understanding relationships with people who put others down: psychology of bullying. Regain. <https://www.regain.us/advice/psychology/understanding-relationships-with-people-who-put-others-down-psychology-of-bullying/>
- Dilon, C. (2020, May). Tiktok Influences on Teenagers and Young Adults students: The Common Usages of The Application Tiktok. https://www.researchgate.net/publication/341616421_Tiktok_Influences_on_Teenagers_and_Young_Adults_Students_The_Common_Usages_of_The_Application_Tiktok
- Donati, C. (2017, August 24). Here's why society has unrealistic beauty standards. Unwritten. <https://www.readunwritten.com/2017/08/24/heres-society-unrealistic-beauty-standards/?amp=1>
- Fannin, R. (2019, September 13). The Strategy Behind Tiktok's Global Rise. *Global Strategy*. <https://hbr.org/2019/09/the-strategy-behind-tiktoks-global-rise?fbclid=IwAR1l-1qD-0GiikxOByU0XCqNUKmu31Z4mrMwQ5OANq4qmYwKnQBL4GGcV18>
- Foo, S. (2010). The beauty trap: How the pressure to conform to society's and media's standards of beauty leave women experiencing body dissatisfaction. <https://core.ac.uk/download/pdf/56361799.pdf>
- Givhan, R., & Morales, H. R., (2020, January 7). The idea of beauty is always shifting. <https://www.nationalgeographic.com/magazine/article/beauty-today-celebrates-all-social-media-plays-a-role-feature?fbclid=IwAR3eWvMkAi4jLgxiuOJ5sDzgiAXYb1eD8WiW7ukcCf5O1wbM8ECKIjG2amM>
- Hill, J. T. (2021, January 12). What is self-worth and how to recognize yours. <https://www.lifehack.org/854916/what-is-self-worth>
- Jaffar, B. A., Riaz, S., & Mushtaq, A. (2019, December). Living in a Moment: Impact of Tik Tok on Influencing Younger Generation into Micro-Fame. *Journal of Content, Community & Communication*, Vol. 5, 187-194. <https://doi.org/10.31620/JCCC.12.19/19>
- Jain, H., & Chanda, R., (2020, September 21). A study to analyse social pressure on female youth for using new media handles in Guwahati. *International Journal of Humanities and Social Science Research*, 6 (5), 55-61. https://www.researchgate.net/publication/344412242_A_study_to_analyse_social_pressure_on_female_youth_for_using_new_media_handles_in_Guwahati



- Jan, M., Soomro, S. A., & Ahmad, N. (2017). Impact of Social Media on Self-Esteem. *European Scientific Journal*, 13 (23), 329-341. <https://doi.org/10.19044/esj.2017.v13n23p329>
- Kabir, H. (2016, June 21). Why Women Need To Grow Their Self-Worth. <https://www.forbes.com/sites/womensmedia/2016/06/21/why-women-need-to-grow-their-self-worth/?sh=6a6bbd496e6d>
- Khattab, M. (2020, January 16). Synching and performing : body (re)-presentation in the short video app TikTok. <https://osuva.uwasa.fi/handle/10024/10471>
- Kotamraju, P. (2018, December 18). The advantages of being a natural beauty. <https://www.tutorialspoint.com/what-the-advantages-of-being-a-natural-beauty>
- Kupp, V. (2016, March 29). What is “Natural Beauty”? *Desired Magazine*. <https://medium.com/@use2beme/what-is-natural-beauty-35dbb79cccb3>
- Laitman, M. (2020, July 9). Time for the Woman Power. *Dr. Michael Laitman*. <https://www.michaellaitman.com/articles/time-for-the-woman-power/>
- Loeffler, L. (2016, April 24). Are you inclusive or exclusive?. *Medium*. <https://medium.com/@lisamloeffler/are-you-inclusive-or-exclusive-ec74d0d83ae8>
- Lores, E. (2016, July 3). Judgemental DIability. *The Society of Honor: the Philippines*. <https://joeam.com/2016/07/03/judgmental-disability/>
- Natarajan, S. (2020, September). The Rise of TikTok and the Unrealistic Beauty Standard. https://www.hercampus.com/school/ncsu/rise-tiktok-and-unrealistic-beauty-standard-1?fbclid=IwAR0EkCvUsrCarrtd7zzJ_Fy-ngPyT_4qpj9CSlGizItEhkz61Os1Ku9SXOo
- Pearce, J. (2019, September 11). The Essence of Contentment: How Acceptance Promotes Happiness. *Good Therapy*. <https://www.goodtherapy.org/blog/the-essence-of-contentment-how-acceptance-promotes-happiness-0911194>
- QS Quacquarelli Symonds. (2019, June 27) How should you respond to negative comments on social media? *Quacquarelli Symonds*. <https://www.qs.com/negative-comments-on-social-media/>
- Razzetti, G. (2018, December 28). Self-Appreciation Is The Foundation Of Life <https://www.lifehack.org/854916what-is-self-worth>
- Schreiner, M. (2017, March 30). People who constantly point out deficiencies in others. *Evolution Counseling*. <https://evolutioncounseling.com/people-who-constantly-point-out-deficiencies-in-others/>
- Shimizu, A. (2016, March). TV says you're ugly: the problem with the media's unnecessary beauty standards in the Philippines. *Asian Breeze*, Vol. 76, 11. http://www.kfaw.or.jp/publication/pdf/AB76_E.pdf
- Yang, Y. (2020, June). Understanding Young Adult's TikTok Usage. *Real People, Creative Videos that Makes Your Day*. https://communication.ucsd.edu/_files/undergrad/yang-yuxin-understanding-young-adults-tiktok-usage.pdf



Internet Addiction Among Students of a Private University in Manila, Philippines: Positional Variations and Psychosocial Wellbeing Outcomes

Reiana Lui Audree A. Domingo, Julianna Joie N. Fullante,
Aril Xacaria V. Lara, and Natalee Reese E. Lim
De La Salle University Integrated School, Manila

Abstract: Internet use has been prominent in today's generation, giving rise to a new phenomenon called Internet Addiction, which affects one's psychosocial wellbeing. This study used cybersex addiction, cyber-relationship addiction, obsessive trading, compulsive web-surfing, and online gaming addiction as internet addiction types. This study determines the influence of personal demographics in the variations of internet addiction levels. Moreover, this study also analyzes the effects of internet addiction on psychosocial wellbeing. Two hundred seventy-nine university students aged 18-22 were used as the population. This study uses a quantitative design in which an online survey was disseminated. Responses were analyzed using T-Test and ANOVA for personal characteristics and internet addiction while Pearson's Correlation and Multiple Linear Regression for the association of internet addiction and wellbeing. Results show that there are significant variations in gender concerning internet addiction forms. Findings suggest males have higher levels of cybersex, cyber-relationships, and online gaming addiction compared to females on the one hand. On the other hand, females have higher levels of online trading addiction compared to males. Concerning the outcomes, university students who have high internet addiction levels negatively affect their family relationships quality among psychosocial wellbeing.

Key Words: adolescents; internet addiction; Manila; private university; psychosocial wellbeing

1. INTRODUCTION

The Internet's popularity as a communication medium has grown in recent years, and it has become an increasingly important part of many people's daily lives (Griffiths, 2000). It has then been recognized as a modern type of addiction, and its factors exhibit signs that are damaging to one's being (Bhattacharyya, 2015; Milani et al., 2019). The normalization of screens and handheld devices has dramatically influenced life's ways that could lead to internet addiction—a habitual compulsion in being attached to technological devices today that hinders an individual from facing and interacting with reality (Young, 1998). The manifestation of social media usage, entertainment platforms, online games, and educational lessons led to people's dependency on mobile devices (Muduli, 2014), especially in today's generation, where students most acquire their needs through the Internet. Young (2000) noted several forms of a new type of addiction called Internet Addiction, which involves computer addiction, net compulsions, information overload, cyber sexual addiction, and cyber-relationship addiction.

An individual's positionality, namely, age, gender, family income, and college department/track, may influence internet addiction. College males are more frequent internet users than college females (Akende et al., 2017; Ellore et al., 2017; Scherer, 1997). Karacic et al. (2017) noted that internet addiction increases as an individual gets older. Adolescents from low-income families borrow their peer's devices to surf the Internet (Adegoke, 2013).

Researchers found out that there is insufficient data regarding Filipino university students that tackle their characteristics as a factor of internet addiction. This study describes the positional variations concerning internet addiction and how it affects one's psychosocial wellbeing.

Out of all the outcomes of internet addiction, wellbeing is frequently being looked into in the literature. Davis (2019) described wellbeing as the practice of being healthy and happy, which entails having good mental health, high life satisfaction, a sense of purpose, and the ability to manage stress. Internet addiction, based on literature, significantly affects the wellbeing of individuals. Several effects of internet addiction may include social isolation, depression, anxiety, sudden mood changes, immense



feelings of loneliness, unhealthy coping mechanisms, and unsatisfactory interpersonal relationships (Milisa et al., 2010; Cole, 2019; Milani et al., 2009). Previous literature presents limited effects of internet addiction on the wellbeing of Filipino students. On the other hand, this present study provides various information on internet addiction situations among Filipino adolescents and their psychosocial wellbeing.

2. METHODOLOGY

This study used a quantitative research design specifically through a descriptive-correlational approach. This study describes internet addiction levels among university students in a private university and its correlation with personal characteristics as associated factors and wellbeing as an associated outcome. This research uses an online self-administered survey as a means to gather data from respondents.

This study's population is students of a private university in Manila City, Metro Manila. This study involved 279 students, which were chosen through purposive sampling. The respondent must be from age 18-22, complied with the survey conditions, and have used the Internet for sexual purposes, gambling, online dating, web surfing, and buying necessities.

Concerning ethical consideration, the researchers have sent the consent forms to the private university in Metro Manila. The online survey link was disseminated in the private university's exclusive community forums and the researchers' social media accounts. Data gathering was done from November 16, 2020, until March 10, 2021.

The results from this survey were encoded in MS Excel and analyzed using Jamovi. Data were analyzed using Descriptive statistics such as the means and standard deviations for the levels of internet addiction. The interval level data, particularly the levels of internet addiction and self-assessed psychosocial wellbeing, were measured using a 5-point Likert scale and categorized into three scales with different ranges: 3.67-5.00 high, 2.34-3.66 moderate, 1.00-2.33 low. Inferential statistical tests such as T-tests and ANOVA determined differences among personal characteristics in association with internet addiction levels. Pearson's r Correlation Coefficient was used to determine any significant correlations between the levels of internet addiction and psychosocial wellbeing. At the same time, the Multiple Linear Regression measured any significant predictors of internet addiction concerning wellbeing based on the study results.

3. RESULTS AND DISCUSSION

3.1. Descriptive and Test of Difference Results

Table 1 presents the descriptive statistics on internet addiction levels among students in a private university in Manila, Philippines. On the one hand, among internet addiction forms, students have moderate levels of compulsive web surfing ($M = 3.23$, $SD = 0.95$) followed by online gaming addiction ($M = 2.71$, $SD = 1.27$). On the other hand, cyber relationships addiction has the lowest level of internet addiction ($M = 1.33$, $SD = 0.62$)

Table 1 also displays the differences in personal characteristics related to internet addiction. Among all factors, variations on gender have statistically significant results concerning internet addiction. Gender is significantly varied in internet addiction on cybersex, cyber relationships, obsessive trading, and online gaming.

Based on the results, males have statistically higher levels of addiction to cybersex ($M = 2.42$) compared to females ($M = 1.35$), $t(277) = -10.80$, $p < 0.001$. This finding suggests that males access pornographic materials online and have higher pornography cravings and frequency of cybersex than women. This finding is consistent with the study of Döring et al. (2015), in which males showed both higher currency and frequency of use of cybersex materials than females. Males also are more addicted to cyber relationships ($M = 1.45$) than females ($M = 1.24$), $t(277) = -2.84$, $p < 0.01$. This finding is parallel to the study by Majors et al. (2017), wherein several participants use the Internet for a romantic relationship. As Bonilla-Zorita et al. (2020) claimed, men are more addicted to cyber relationships since they are more open to inter-racial dating, just like how diverse the users of online dating applications are. Lastly, males have higher levels of addiction to online gaming ($M = 3.29$) compared to females ($M = 2.23$), $t(277) = -7.58$, $p < 0.001$. Based on the study of Veltri et al. (2014), online gaming is frequently dominated by male players who are more motivated to play, and the frequency and time in playing are higher. This result is also possibly caused by perceptions that gaming is a male domain.



Table 1. Differences in Personal Characteristics concerning Internet Addiction, n=279

Independent Variables	Cybersex Addiction	Cyber-relationship Addiction	Obsessive Trading	Compulsive Web Surfing	Online Gaming Addiction
Gender					
t-Statistic Score	-10.80***	-2.84**	3.21***	-1.74	-7.58***
Mean of Females	1.35	1.24	2.48	3.14	2.23
Mean of Males	2.42	1.45	2.07	3.34	3.29
Age					
t-Statistic Score	0.60	1.94	0.07	0.22	1.39
Mean of 18-19 years old	1.85	1.37	2.29	3.23	2.77
Mean of 20-22 years old	1.77	1.19	2.28	3.20	2.51
Family Income					
t-Statistic Score	0.03	0.10	-1.26	-0.15	1.72
Mean of ≤ ₱60,000.00	1.84	1.34	2.18	3.22	2.89
Mean of > ₱60,001.00	1.84	1.33	2.35	3.23	2.62
Academic Program Cluster					
F-Statistic Score	0.59	0.30	1.42	1.36	2.61
Mean of Accounting and Business	1.88	1.31	2.33	3.30	2.43
Mean of Humanities and Social Science	1.90	1.37	2.43	3.32	2.88
Mean of Science and Technology	1.77	1.31	2.18	3.13	2.73
Means	1.84	1.33	2.29	3.23	2.71
Standard Deviations	0.98	0.62	1.09	0.95	1.27

*p-value<0.05; **p-value<0.01, ***p-value<0.001

The findings also suggest that among internet addiction domains, females have higher significant levels in trading as an addiction (M=2.48) compared to males (M=2.07), $t(277) = 3.21, p < 0.001$. This result may infer that women are more likely to shop for things impulsively and leisurely. This finding is supported by a survey conducted by First Insight (2018), wherein women are more likely to shop on the Internet than male. Based on the survey results, 40% of women frequently shop online than 22% of men (Thomas, 2018).

3.2. Pearson's r Correlation Coefficient Test Results

Table 2 presents the significant correlations using the Pearson's r correlation coefficient test. Based on the results, only quality of peer and family relationships are significantly correlated outcomes of internet addiction forms. Only obsessive trading was presented as a significant correlation for quality peer relationships as a psychosocial wellbeing dimension. Obsessive trading has a statistically positive however very weak correlation, $r(277) = 0.12, p < 0.05$. This finding presents that the relationship may not have a bearing due to a negligible correlation.

For quality family relationships as a dimension of psychosocial wellbeing, addiction to cybersex presents the strongest correlation among internet addiction forms. Cybersex addiction has a highly statistically significant and negative, somehow weak correlation, $r(277) = -0.22, p < 0.01$. This finding presents that the relationship may not have a bearing due to a negligible correlation. This result interprets that high levels of cybersex addiction negatively associate with the quality of family relationships. This finding is supported by a study conducted by Tsitsika (2009), which states that exposure to sexually explicit materials may cause irrational sexual attitudes to develop, leading to adverse effects on family relationships.

Table 2. Pearson r Correlation Coefficient Test Results, n=279

Variables	1	2	3	4	5	6	7	8
Internet Addiction Variables								
1. Cybersex	--							
2. Cyber relationships	0.30**	--						
3. Trading	0.01	0.24**	--					
4. Web Surfing	0.21**	0.22**	0.32**	--				
5. Online Gaming	0.28**	0.11	-0.00	0.24**	--			
Psychosocial Wellbeing Variables								
6. Emotional Wellbeing	-0.40	0.08	0.06	-0.30	-0.01	--		
7. Peer Relationships	0.10	0.09	0.12*	0.09	0.10	0.15	--	
8. Family Relationships	-0.22**	-0.15*	0.05	-0.13*	-0.17**	0.45**	0.19**	--

*p-value<0.05; **p-value<0.01, ***p-value<0.001

3.3. Multiple Linear Regression Analysis Results

Table 3 presents the multiple linear regression results. Based on the findings, only quality of family relationships out of all the psychosocial wellbeing variables presented as a significant effect of the model. However, it only shows 8% of the proportion of variance in quality of family relationships scores, $R^2 = 0.08, F(5, 273), p < 0.001$.

Table 3. Multiple Linear Regression Results, n=279

Model	Covariates	β	t-statistic	p-value	R ²	F-statistic	p-value
1 (Emotional Wellbeing)	Internet Addiction				0.01	0.74	0.59
	Cybersex	-0.05	-0.838	0.40			
	Cyber relationships	0.14	1.386	0.17			
	Online Trading	0.05	0.804	0.42			
	Web Surfing	-0.06	-0.864	0.39			
2 (Peer Relationships)	Internet Addiction				0.03	1.78	0.12
	Cybersex	0.06	0.958	0.34			
	Cyber relationships	0.05	0.583	0.56			
	Online Trading	0.09	1.640	0.10			
	Web Surfing	0.01	0.221	0.83			
3 (Family Relationships)	Internet Addiction				0.08	4.73***	0.00
	Cybersex	-0.15*	-2.40	0.02			
	Cyber relationships	-0.15	-1.53	0.13			
	Online Trading	0.09	1.63	0.10			
	Web Surfing	-0.09	-1.32	0.19			
	Online Gaming	-0.07	-1.51	0.13			

*p-value<0.05; **p-value<0.01, ***p-value<0.001

Based on the model, only cybersex addiction statistically can predict the quality of family relationships. The finding suggests that high levels of cybersex addiction led to negative levels of quality of family relationships, $\beta = -0.15, t(277) = -2.40, p < .05$. This finding suggests that individuals struggling with sexual addiction may become withdrawn and hesitant to discuss this with their partners and family in fear that they will leave them (Schneider, 2003). With that, cybersex addiction affects the emotional stability and relationship qualities of families.

4. CONCLUSIONS

The continuous growth in the number of internet users directly affects the severity and development of internet addiction. In conclusion, gender presents significant variations concerning internet addiction. Male university students have higher occurrences among internet addiction levels, particularly in the forms of cybersex, cyber relationship, and online gaming. In contrast, female university students have higher levels of online trading obsession.

Regarding the association between internet addiction and its effect on psychosocial well being, all



internet addiction domains negatively affect family relationship quality. On the one hand, addiction to sexual materials on the Internet involves both the parents' and children's trust and openness due to the fear of possible uncertain reactions. On the other hand, high levels of online trading positively influence peer relationships. This is mainly because online trading involves interacting with other people, thus enhancing their relationship as it acts as both an entertainment and social activity. Ultimately, based on the models, only being addicted to cybersex has notable adverse effects on family relationships.

The data collected is limited since no follow-up survey or interview was conducted. It is suggested for other future researchers to use a qualitative study in a topic similar to this for the observation of more elaborated results. The population is limited since only students of one private university studied. Future researchers may opt to study students from other universities as well in order for the results to be more generalized to the students belonging in a specific age group.

5. ACKNOWLEDGMENTS

The researchers extend their greatest gratitude to their research adviser, Mr. Wilfred Luis Clamor of the Behavioral Sciences Department in De La Salle University-Manila for his support and patience during the writing of this research paper. The researchers also like to take this opportunity to acknowledge Mr. Christian Gopez, the Research Coordinator for HUMSS, ADT, and SPT of De La Salle University-Manila Integrated School, for his guidance and encouragement. The researchers would also like to thank their parents for their continuous support in the writing process. The researchers also give thanks to their friends and block mates, who have been there to motivate them. Most importantly, the researchers acknowledge God's presence for His guidance and always keeping the researchers and significant people safe.

6. REFERENCES

- Bhattacharyya, R. (2015). Addiction to Modern Gadgets and Technologies Across Generations. Volume 18 Issue 2. <https://pdfs.semanticscholar.org/f9e4/e4f8bad45aba49553ca3d3b9efa7b9f7ceab.pdf>
- Bonilla-Zorita, G., Griffiths, M.D., & Kuss, D.J. (2020). Online Dating and Problematic Use: A Systematic Review. *International Journal of Mental Health and Addiction* (2020). <https://doi.org/10.1007/s11469-020-00318-9>
- Cole, L. (2019). Internet and Technology Addiction – Causes, Signs and Tips to Stop. *MentalUP*. <https://www.mentalup.co/blog/causes-losses-and-prevention-of-technology-addiction>
- Davis, T. (2019). What is Well-Being? Definition, Types, and Well-Being Skills. *Psychology Today*. <https://www.psychologytoday.com/us/blog/click-here-happiness/201901/what-is-well-being-definition-types-and-well-being-skills>
- Döring, N., Daneback, K., Shaughnessy, K., Groy, C., & Byers, E.S. (2015). Online Sexual Activity Experiences Among College Students: A Four Country Comparison. <https://doi.org/10.1007/s10508-015-0656-4>.
- Griffiths, M. (2000). Internet Addiction – Time to be Taken Seriously? *Addiction Research*. 8(5), 413 – 418. <https://doi.org/10.3109/16066350009005587>
- Karacic, S., & Oreskovic, S. (2017). Internet Addiction Through the Phase of Adolescence: A Questionnaire Study. *JMIR Mental Health*. <https://dx.doi.org/10.2196%2Fmental.5537>
- Majorsy, U., Hapsari, I., Valentine, V., Ayuningsih, A.M. (2017). Contribution of Cyber-Relationship Motive to Interpret Addiction in Adults. *Analitika*. <https://doi.org/10.31289/analitika.v9i2.1393>
- Milani, L., Osualdella, D., & Di Blasio, P. (2009). Quality of Interpersonal Relationships and Problematic Internet Use in Adolescence. <https://doi.org/10.1089/cpb.2009.0071>
- Muduli, J.R. (2014). Addiction to Technological Gadgets and Its Impact on Health and Lifestyle: A Study on College Students. *National Institute of Technology Rourkela*. http://ethesis.nitrkl.ac.in/5544/1/e-thesis_19.pdf
- Owens, E., Behun, R., Manning, J., & Reid, R. (2012). The Impact of Internet Pornography on Adolescents: A Review of Research. *Sexual Addiction & Compulsivity* pp. 99-122. <https://doi.org/10.1080/10720162.2012.660431>
- Schneider, J. (2003). The impact of compulsive cybersex behaviours on the family. *Sexual and Relationship Therapy*, 18(3), 329-354. <https://doi.org/10.1080/146819903100153946>
- Thomas, L. (2018). Men aren't willing to shop online as much as women, survey finds. *CNBC*. <https://www.cnb.com/2018/03/19/men-arent-willing-to-shop-online-as-much-as-women-survey-finds.html>
- Veltri, N., Krasnova, H., Baumann, A., & Kalaymthanam, N. (2014). Gender Differences in Online Gaming: A Literature Review. <https://core.ac.ul/download/pdf/301361965.pdf>
- Yebowaah, F.A. (2018). Internet Use and Its Effect on Senior High School Students in Wa Municipality of Ghana. *Library Philosophy and Practice*. <https://digitalcommons.unl.edu/libphilprac/1817/>



The Effects of Church Service on the Identity Formation of Baptized Roman Catholic Gay Youth

Carlo D. Bautista, Simon Emmanuel R. Reyes, and Veejay Olivine S. Wang
De La Salle University Integrated School, Manila

Abstract: This study explored the lived experiences of gay persons who have dedicated their lives to Church service and how they integrate their Catholic and gay identities through a Phenomenological study and the employment of semi-structured interviews which allowed participants to deduce their own meanings for their own lived experiences. The study concluded that there existed both narratives of successful reconciliation through a reexamination of faith and narratives of religious detachment.

Key Words: gay; religion; church; sexuality; faith

1. INTRODUCTION

The Philippines is predominantly Catholic, with religion bleeding into folkways and traditions in the archipelago. Despite fluctuations in religious participation historically Filipinos have constantly branded themselves as religious and devout (Abad, 2001). Religion has always played a role in most Filipino narratives, and it is no surprise that it bleeds even in personal stories of identity formation. Singh (2015) argues that religion has to play a role in intersectionality, discussing religious women's agency and their identity in relation to religion.

Relating this to Singh (2015), it can be argued that religion trickles into the agency of gay individuals to express themselves. Literature on Philippine gay experiences has always involved discussing microaggressions or more subtle homophobic expressions (Tang & Poudel, 2018). However, with the turn of the century, research exploring the links between religion and social and individual attitudes towards sexuality has arisen (Toscano, 2017).

Especially for a country like the Philippines with strong Catholic ties, the intersection between being Catholic and other facets of their personhood becomes prominent. In a Canadian study by Liboro and Walsh (2016), Gay men with HIV and AIDS found ways to reconcile their identities with their Catholic devotion by fixating on the Church's teachings despite internal conflict caused by anti-gay Church sentiments. A study involving LGBT-affirmative Church members also introduced other narratives of in-Church oppression, wherein participants reconciled their identities by resorting to what is called a "personalization" of their faith by selective adherence to Christian doctrines that do not antagonize their gay identities (Evangelista et al., 2018). From these findings, it can be inferred that religious and sexual identities are highly important to these individuals, as their efforts to reconcile their Catholicism and their

gayness imply that they cannot relinquish either of these identities.

Most of these studies gravitate towards being Phenomenological when employing dialogue as a method, as it allows participants to deduce their own meanings from their lived experiences, which is essential in having an authentic discourse about the lives of historically marginalized sectors so as not to let preconceived biases penetrate the data (Smith, 2013).

The consensus, therefore, is that these religious and gay identities have an intersection, especially for gays who devote years of their lives to Church service through faith-based communities such as parishes, chapels, and youth organizations. With this in mind, the researchers aimed to answer the following questions to explore this intersection:

What are the lived experiences of participants as gay youth and how does their gay identity shape their religious participation?

What are the lived experiences of participants as Roman Catholics and how does their Catholic identity shape their gay identities and experiences?

2. METHODOLOGY

2.1. *Research Design*

The research adopts a phenomenological design to explore lived experiences and narratives of gay Roman Catholic youth's phenomena in a first-person viewpoint (Smith, 2013). This was chosen to give justice to the participants' abilities to deduce meanings behind lived experiences and narratives presented, as both views and understanding are subjective. The design allows for bracketing from preconceived notions coming from the researchers.



2.2. Sampling

Participants were recruited from personal networks from which additional recruits were sought from inducted participants through snowball sampling. Participants were to affirm the criteria: gay (male same-sex attraction), Roman Catholic, part of the youth sector (aged 18-24), residing within Greater Manila, and member of any Catholic faith-based organization. Recruiting was one month and ceased upon the minimum threshold of seven. All were given the appropriate forms for consent and duly signed.

2.3. Instrumentation

Semi-structured interviews were employed for participants to express with liberty their lived experiences. The questions asked were broadened so as not to constrain answers. The researchers also raised additional questions based on the participants' given answers to explore arisen points of interest within the interview. They explored themes on gayness, church service, church service-affecting gayness, and gayness affecting church service. Interviews were conducted online.

2.4. Data Gathering Procedure

Interviews were conducted in a month on video conferencing programs and transcribed word-for-word. Recordings stored in a drive and transcriptions compiled in one file with readied access should a reexamination be required. Authorization access to the drive was granted to researchers and the research adviser. The researchers mentioned protocols and necessary information regarding the interview to the participants before it formally began. Once all possible avenues for discussion are exhausted, the interview is then concluded. Recordings of the interviews shall be deleted upon completion of research following regulations.

2.5. Data Analysis Strategy

Interviews were analyzed using the general thematic analysis model, similar to Liboro & Walsh (2015), but the theoretics employed are different. The narratives—analyzed, moving away from the specifics to the general overarching and common themes. Codes are then generated according to theme similarities (Braun et al., 2019). Intrinsic links between Catholic and Gay identities were then proven in the results' analysis using the Theory of Intersectionality.

3. RESULTS AND DISCUSSION

3.1. On Being Gay

Experiences of Self-Discovery

“Pero ngayon, uh, nung ano, uh nag-open kasi sa’kin best friend ko, which is uh, yung bi din. Gay man din; and ayun, mas naging open ako.” - “Charlie”, 18

The respondents were subject to a plethora of circumstances that initiated a process of coming into terms with their gay identities. These involved either extended periods of self-reflection or were prompted by external factors such as friends undergoing similar processes of discovering their identities.

Varying Degrees of Acceptance

“...Nung una parang may... may panghihinayang ganun (after coming out). Pero inaccept na lang rin naman nila . Di ‘ko alam kung tolerance or acceptance ‘yun...” - “Bravo”, 18

The expression of these participants' gayness received varying degrees of acceptance from their social groups. Most reported the maintenance and even improvement of rapport and connections with friends. This acceptance, however, was sometimes conditional, with people telling them that their acceptance is contingent on factors like knowing their personal boundaries. Only a few instances of non-acceptance were reported among the participants, which commonly come from family environments.

Policing One's Own Sexual Identity

“Yun na nga. Mas... mas masculine yung nga yung dating and I guess mas quiet ako d'on sa simbahan. That's it.” - “Golf”, 18

Because of the varying levels of acceptance from these social groups, gay persons learned to police the manifestations of their sexual identity. Depending on the acceptance they felt from the community, gay persons expressed themselves and dealt with relationships in different ways. They toned these expressions down in environments they felt uncomfortable in and were more expressive of their identities in environments they felt were more accepting. Self-expressions were on a spectrum of either being masculine, effeminate, or a combination of both.

3.2. On Religious Participation

Adherence to Catholic Beliefs and Principles

“..I think nananaig yung love ko for God. Maybe my relationship with Him is stronger than what I believed in. Like lumaki akong naniniwala na



God loves me and... ano... loves anyone else who is like me.” - “Foxtrot”, 23

The participants relayed different narratives about their adherence to Catholic beliefs as Church servants. Some were taught traditional Catholic values by their families, with a few even supporting Catholic practices such as the Traditional Latin Mass, participating in collecting santos, and the like. The stories that demonstrate this also differ, with some growing to be more devout than others. These participants’ commonalities involved some sort of familial indoctrination with active church involvement that led to the construction and reinforcement of these beliefs.

Engagement in Church Service

“...Ako yung isa sa mga leader. Ako yung nagde-delegate ng mga tasks for example... And, ako yung nagche-check kung complete na yung mga gamit... and minsan, um... ako rin nagcocontact dun sa... dun sa pari, ‘pag wala pa.” - “Charlie”, 18

These participants all served as parts of ministries or guilds of altar servers, and most started while they were very young. They were either influenced into joining by the same families that taught them their Catholic values or were willing to serve beyond attending Mass for more devout participants. Different parishes and ministries offered various experiences in service, like being elected into positions of authority because of their seniority, having different communal activities, and being involved in Mass preparations.

Expectation to Church Servers

“...Required sa amin... may proper decorum kami eh. Like yung haircut, everything. Actually nga pala rin eh, lahat, pati kuko, dapat malinis.” - “Alpha”, 21

During their years of service, these participants experienced being held to standards and expectations towards church servers. These expectations were both self-imposed and were reminders that came from seniors or priests themselves. These standards included proper modes of physical presentation, decorum, and work ethic, which were exercised with different degrees of stringency.

3.3. On the Effects of Religious Participation on Being Gay

Interrogating One’s Gayness Based On Catholic Beliefs

“For example, ‘yun nga; sexuality, homosexuality is accepted by the Church. So parang, nagkakaroon ako ng tug-of-war... tug-of-war between

those two... ano... two opposing liturgies sa’ting simbahan.” - “Echo”, 18

As was discussed in the previous section, these participants were subject to experiences of determining their sexual identities in their formative years, with some questioning their identities until now. They questioned how they would find ways to reconcile their Catholic identity with their gay identity, which they viewed as contradictory. Most felt stages of heightened internal conflict, which they reconciled in ways that will be discussed in the fourth subsection. Moreover, this internal conflict was aggravated by the fact that they saw no clear stance from the Church regarding their identities.

Church’s Tolerance for Gay Persons

“Hindi siya na parang sinasabi na, “Pag bakla ka, makasalanan ka na.” Hindi pinaparamdam. Sa amin mas na-we-welcome.” - “Alpha”, 21

The participants also experienced varying levels of tolerance from peers, specifically those from the Church and the priests. Most said they could reconcile their identities because of these groups’ welcoming attitudes once they came out. A few even reported encouragement from their churchmates to be themselves or were amused by them whenever they showed more effeminate expressions of their sexuality. For those with more conservative backgrounds, church individuals even respected them enough not to out them. There were, however, instances of homophobia from some of their peers, which they responded to in varied ways.

3.4. On The Effects of Being Gay to Religious Participation

Decreasing Faith and Religious Participation

“...In my case kasi, like... ‘pag... ‘pag... ‘pag nagro-rosary kasi, ‘pag ganon, ano... like... wala talaga ako na nararamdaman.” - “Delta”, 18

Some respondents chose to eventually depart from church service and become detached from their faith entirely. They were influenced by a change in more secular environments or had modified beliefs about the Church and Catholicism. These environments made them more pragmatic-based thinkers or rethink their stance on the church, which they argued heightened their internal conflict. These individuals gave more importance to their freedom to exercise their identities rather than finding a middle ground between that and their service.

Gay Perspectives on Religious Service

“I’m still willing to stay... Kasi parang, gusto kong... ‘di naman sa parang gusto ko ah. Parang, I’m willing to take risk. I’m willing to be a martyr for the



Church.” - “Echo” - 18

Most participants formed gay perspectives on church service that strengthened or maintained their relationship with the Church. Most of these perspectives revolved around service being a way to reconcile their identities with God. They formed notions that being gay is acceptable if one devotes himself to his religious service and knows his Catholic duties. They also shared that despite the many flaws and criticisms they have for the church, their notion of God being all-loving is enough for them to disregard these institutional flaws.

As was found in previous studies, gay youth who have histories of Church service still find it in themselves to reconcile their gay identities with their religiosity. Much like the study conducted by Liboro & Walsh (2015), they reconciled their identities by allowing Catholic doctrines on a loving God to supersede their negative experiences of oppression. Though they had instances of self-interrogation based on their Catholic values, they were assured their service was enough of a reconciliation with God, along with perceived tolerance and acceptance from their church communities. Some also reconciled their identities by modifying their beliefs and perceptions that are based on Church teachings so that the latter could accommodate their sexual identities (Evangelista et al., 2018). It seems as well that most of these participants embraced the duties that they felt were expected of them as Catholics and found ways to integrate these roles into their gay lives.

However, a new phenomenon among participants revealed a new narrative trajectory that involved a gradual decrease in faith, especially those that transitioned into environments that directly challenged their Catholic faith. These were participants exposed to more secular social groups and those whose family environments provided a backdrop of either outright or subtle homophobia based on Catholic values. These participants made clear that their families had heightened importance on their Catholic practices, thus their intolerance for gayness. However, this does not invalidate other participants' families whose Catholicism coincided with their acceptance of gayness. If anything, the difference in the spectrum further proves the point discussed by Etengoff and Daiute (2014) that families shape their religious contexts and how they apply them, rather than the reverse of religious systems directly affecting them. It also proves the intrinsic links between Catholic beliefs and attitudes towards sexuality.

4. CONCLUSIONS

In conclusion, how the participants reach such conclusions on their two identities remain varied. However, an overarching paradigm of reconciliation versus detachment arises from them when faced with

the prospects of clashing identities. The intersection of the gay adolescent and Roman Catholic identities places the participants at a choice to either reconcile their two identities to form one cohesive or overall identity or detach from one of them if they deem it as unacceptable to their overall identity.

Future studies may employ a participant demographic with a wider range of ages and compare the religious integration of people from different age groups. Since there are references to family backgrounds, future research can identify the agency of these families over their religious contexts and how they use Roman Catholicism with family members who have come out as gay, and how both the families and the gay individuals characterize the family environment after the coming out experience.

5. ACKNOWLEDGMENTS

The researchers would like to thank Mr. Jerome Cleofas as their research adviser and mentor, for his guidance throughout every stage of the research process. They would also like to thank their class adviser, Mr. Xavier Dwight Gentalian, for his assistance in their correspondences with the Research Coordinator.

6. REFERENCES

- Abad, R. (2001). Religion in the Philippines. *Philippine Studies*, 49(3), 337-367. <https://www.jstor.org/stable/42634448>
- Braun, V., Clarke, V., Hayfield, N., & Terry G. (2019, April). Thematic analysis | a reflexive approach. University of Auckland. <https://www.psych.auckland.ac.nz/en/about/thematic-analysis.html>
- Etengoff, C., & Daiute, C. (2014). Family Members' Uses of Religion in Post-Coming-Out Conflicts With Their Gay Relative. *Psychology of Religion and Spirituality*, 6(1), 33-43. 10.1037/a0035198
- Evangelista, Z. M., Dumaop, D. E., & Nelson, G. (2016). Journeying to a Safe Space: Sexual and Religious Identity Integration of Filipino LGBT-Affirmative Church Members. *Philippine Journal of Psychology*, 49(2), 101-133.
- Liboro, R., & Walsh, R. M. (2016). Understanding the Irony: Canadian Gay Men Living with HIV/AIDS, Their Catholic Devotion, and Greater Well-Being. *Journal of Religion and Health*, 55(2), 650-670. 10.1007/s10943-015-0087-5



Singh, J. (2015). Religious Agency and the Limits of Intersectionality. *Hypatia*, 30(4), 657-674.
<https://www.jstor.org/stable/24541974>

Smith, D. (2013). Phenomenology. In E. N. Zalta (Ed.). *Stanford Encyclopedia of Philosophy*.
<https://plato.stanford.edu/archives/sum2018/entries/phenomenology/>

Tang, X., & Poudel, A. (2018). Exploring challenges and problems faced by LGBT students in Philippines: A qualitative study. *Journal of Public Health Policy Plan* 2018, 2(3), 9-17.

Toscano, M. E. (2017). Intersectionality of Religion/Spirituality and Sexual and Gender Identity.

Psychology of Religion and Spirituality, 9(4), 399-400.
<http://dx.doi.org/10.1037/rel0000151>



Determinants of Sexual Literacy of Senior High School Students in De La Salle University-Manila

Nigiel T. Aral, Maxene Alexandra M. De Castro,
Karuna May T. Mansukhani, and Ayeesha Heather M. Sara
De La Salle University Integrated School, Manila

Abstract: Sexual literacy is an important aspect of the formative development of individuals as it influences their capacity to think about and act upon factors affecting the sexual aspect of their lives. However, achieving a certain level of sexual literacy is still a complex path in society, especially in prestigious schools in the Philippines such as De La Salle University Manila (DLSU-M). This study aims to assess DLSU-M Senior High School (SHS) students' level of sexual literacy, determine factors significantly explaining it, and form statistical models based on the significant factors. Both Poisson regression models and Logistic regression models revealed significantly higher sexual literacy scores among students with Chinese ethnicity, teacher as main source of information on relationships and sex, and mother as secondary source of information on reproductive health. Furthermore, Poisson regression models also revealed that favoring Lesbian, Gay, Bisexual, Transgender, Queer and/or Questioning, Intersex, Asexual and/or Ally, and others (LGBTQIA+) rights is also a significant predictor of sexual literacy. Therefore, educators such as parents and teachers positively impact an SHS student's sexual literacy. Their immediate environment is especially significant in honing their comprehension regarding sexual and reproductive health, thus, a more open yet secure space must be reinforced.

Key Words: sexual literacy; shs students; reproductive health; developing countries; education

1. INTRODUCTION

Philippine society has been conservative and uptight when it comes to addressing issues regarding sexuality and reproductive health -- leaving the youth at risk for unplanned pregnancies, sexually-transmitted diseases, and other related complications. The 2017 Annual Poverty Indicator Survey (APIS) revealed that there are 3.6 million out-of-school youth deprived of quality education in both aspects of academics and morals (Philippine Statistics Authority (PSA), 2017). Millions of children are at risk because they have insufficient knowledge regarding sexuality and health.

According to the Young Adult Fertility and Sexuality Study (YAFS) in 2014 and 2016, lack of sex education, prevalence of poverty, culture, religion, perceived inappropriateness of the discussion of sex at home, gender, and sexuality variables may also contribute to sexual literacy.

Sexual literacy is a concept and skill which must be integrated into the education of the SHS students, as it contributes greatly to

their sexuality and reproductive health protection. Assessing the sexual literacy of SHS students reveals certain gaps in their education. Fulfilling the following objectives may allow the formation and implementation of a more strategic and systemic solution in honing students' sexual literacy.

This study aims to profile DLSU-M SHS students in terms of sexual literacy, identify the determinants of these students' sexual literacy, and build statistical models of sexual literacy based on its significant determinants. Through appropriate statistical tests and modeling procedures, it offers interpretations for the possible relationships between sexual literacy and the different determinants.

2. METHODOLOGY

2.1 *Research Design*

This study is quantitative in nature, and utilized appropriate statistical analyses to determine factors explaining sexual literacy of DLSU-M SHS students.



The dependent variables are objective multiple choice questions to assess the respondents' sexual literacy based on knowledge on (1) sexual mechanisms (four items, cronbach's $\alpha = 0.70$), (2) HIV/AIDS (two items, cronbach's $\alpha = 0.88$), (3) contraception (six items, cronbach's $\alpha = 0.66$), and (4) LGBTQIA+ terminology (eight items, cronbach's $\alpha = 0.74$). Each subsection was considered a separate dependent variable, and the cumulative score worth 20 points was also a separate variable, for a total of five dependent variables in this study.

Meanwhile, the independent variables include personal information, attitudes toward sexuality, sources of information on sex, etc. For the complete list of independent variables, see Table 12 in the Appendix.

2.2. Sampling and sample size

From the population of consenting SHS students, $N = 1133$, the initial sample size, $n = 385$ was calculated using 5% sampling error (Demographic Research and Development Foundation Inc. [DRDF] & University of the Philippines Population Institute [UPPI], 2016), 95% confidence interval (Alzate et al., 2020), and a 0.5 estimate of true proportion, which gives the maximum possible sample size. Considering this sample size was more than 5% of the population, Finite Population Correction Factor (FPC) was applied, resulting in a final sample size of $n = 288$.

Respondents were sampled randomly from the said population using stratification according to batch since grade 12 students have likely adjusted to the culture and norms of the school while the grade 11 students are newcomers and probably still have the mindset they have from their previous schools. Cluster sampling was also done by taking random samples from the class sections of grade 12 and grade 11. This method was used as the samples that were taken from each batch are heterogeneous due to their various personalities and backgrounds. Out of the 677 students in the sampled clusters, 289 responded, which satisfied the required 288.

2.3. Data Analysis

Descriptive statistics were calculated to present a basic level of understanding of the sample. However, since these values are restricted to the sample, inferential statistics were processed in order for conclusions to be drawn about the entire population in this study.

Hypothesis tests were carried out to compare two or more groups classified by the categorical independent variables in this study. Non-parametric tests such as the Mann-Whitney U test (for exactly two groups) and Kruskal-Wallis H test (for at least two groups) were used to determine whether or not

there was significant difference in sexual literacy among the groups at the 0.05 significance level.

The parametric counterparts of these tests were not used since the sample values from the five dependent variables failed to satisfy the common assumption of normality. In particular, the Kolmogorov-Smirnov test for normality revealed five p-values less than 0.01, rejecting the null hypothesis of normality.

Poisson regression and logistic regression were used to analyze all independent variables simultaneously, and determine which of these explain sexual literacy at $\alpha = 0.05$. The five dependent variables in this study are count variables, which fit the requirements of Poisson regression. For its execution, backward elimination was done using Statistica wherein the variable with the highest p-value at every run was eliminated until only significant ones remain at $\alpha = 0.05$. The multiple Poisson regression model is as follows

$$y = +1x_1 + 2x_2 + \dots + kx_k$$

where y = dependent variable; x_1, x_2, \dots, x_k = significant independent variables; $1, 2, \dots, k$ = estimated coefficients

Exponentiating both sides assures that the right hand side of the equation has a positive value, allowing for a practical interpretation of data. This model will reveal the actual estimated score based on the values of the significant factors.

$$y = +1x_1 + 2x_2 + \dots + kx_k = e(e^1)x_1(e^2)x_2(e^k)x_k$$

Logistic regression was used as a secondary model to explain other possible variable relationships, and assumes that the dependent variable has two values encoded as "0" and "1." In this study, these values are low literacy (at most half of the total score) and high literacy (more than half of total score), respectively.

The four levels of health literacy of the European Health Literacy Survey (HLS-EU-Q47) are 'inadequate' (0–25), 'problematic' (>25–33), 'sufficient' (>33–42), and 'excellent' (>42–50) (Sørensen et al., 2015). In this study, the 'inadequate' level or half of the total score was considered low literacy and high literacy was the aggregation of the 'problematic', 'sufficient', and 'excellent' levels, which is equivalent to greater than half of the total score.

3. RESULTS AND DISCUSSION

3.1 Descriptive Statistics

With 95% confidence, the mean sexual literacy score in the population of all DLSU-M SHS students is between 12.8 and 13.6 out of 20. Since the interval is higher than half of 20, the mean sexual literacy score is considered high.



Table 1. Descriptive Statistics

	kno_sexm	kno_hivs	kno_cont	kno_lgbt	kno_tot
Mean	3.00692042	1.59861592	2.6816609	5.9031142	13.190311
Median	3	2	3	6	14
Mode	3	2	3	7	15
Standard Deviation	0.90903291	0.62204704	1.4052392	1.7651007	3.4098167
Skewness	-1.019088	-1.29459869	0.2021728	-0.7826178	-0.6089483
Range	4	2	6	7	17
Minimum	0	0	0	1	3
Maximum	4	2	6	8	20
95% CI	[2.9, 3.11]	[1.53, 1.67]	[2.52, 2.84]	[5.7, 6.11]	[12.8, 13.6]

3.2 Basic Inferential Statistics

3.2.1 Mann-Whitney U test

There is no significant difference between biologically male and female students in terms of their knowledge in sexual mechanisms, HIVs, reproductive health, and gender and sexual orientation.

Table 2. Mann-Whitney U Test by Sex Assigned at Birth

Variables	kno_tot	kno_sexm	kno_hivs	kno_cont	kno_lgbt
Value of test statistic	9860.0000	10333.0000	9671.0000	10164.5000	9041.5000

*significant at 0.05 level of significance

3.2.2 Kruskal-Wallis H test

At $\alpha = 0.05$, students' academic strands, sexual orientations, and romantic orientations each have a significant relationship with total score and with score in the gender and sexual orientation portion of the exam. Moreover, students of various gender identities also have significantly different scores in the sexual mechanisms section, implying that being part of the LGBTQIA+ community might increase students' knowledge on gender and sexuality. Furthermore, students of various ethnicities have a significant difference in their score in the same section, implying that people from different cultural backgrounds may have different perspectives when it comes to sexual engagement.

However, no significant variables were found to explain the scores in both the HIV section and the reproductive health knowledge section.

Table 4. Kruskal Wallis H Test by Independent Variables with More Than Two Categories

Variables	Value of Test Statistic				
	(kno_tot)	(kno_sexm)	(kno_hivs)	(kno_cont)	(kno_lgbt)
Strand (sfc_sbs)	14.6000*	8.9513	2.8714	9.1815	11.1735*
Sexual Orientation (pin_sex)	15.8891*	4.1259	1.7500	3.7745	30.6880*
Romantic Orientation (pin_romo)	11.8223*	2.4083	5.1943	2.5884	24.7057*
Gender Identity (sfc_gen)	6.3382	1.1161	4.2823	2.6067	19.7018*
Ethnicity (sfc_ethn)	20.5851	21.2982*	13.0935	12.6613	17.2176

*significant at 0.05 level of significance

3.3 Statistical modeling

3.3.1 Poisson regression

The factors that significantly explain total score are att_right (favoring LGBTQIA+ rights), eth_chi (Chinese ethnicity), mrel_tea (teacher as main source of information on relationships and sex), and srep_moth (mother as secondary source of information on reproductive health).

Those who selected mrel_tea have a total sexual literacy score that is $e^{0.097711} \approx 1.1026$ times the score of those who did not, with other factors held constant. Additionally, the population who selected srep_moth has a total score that is $e^{0.094930} \approx 1.0996$ times that of those who did not, all other things being the same. These imply that educators such as teachers and parents are major influences on SHS students' sexual literacy.

Table 4. Poisson Regression on Total Sexual Literacy Scores

Effect	Estimate
Intercept	2.28899*
eth_chi	0.049417*
srep_moth	0.094930*
mrel_tea	0.097711*
att_right	0.313338*
att_right	-0.451614*
att_right	0.011175

*significant at 0.05 level of significance

The following results show that the reproductive health exam score of students who selected mrel_tea is $e^{0.184536} \approx 1.2027$ times the score of the others, holding other factors constant. This is because perhaps, schools' curricula focus on this topic. Meanwhile, students who came from technical schools (jhs_tech) have a score that is just $e^{-0.577885} (\approx 0.5611)$ times that of the other students, with other factors held constant.



Table 5. Poisson Regression on Reproductive Health Section

Effect	Estimate
Intercept	1.398411*
mrel_tea	0.184536*
jhs_tech	-0.577885*

*significant at 0.05 level of significance

The factors that explain knowledge regarding gender and sexual orientation are kina_plat (have experienced platonic attraction), att_cohab (is against cohabitation before marriage), and srep_moth. The model shows that the experience of platonic attraction lowers kno_lgbt, leading a student's score to be multiplied by $e^{-0.096332} \approx 0.9082$, holding other factors constant. Meanwhile, those who strongly disagree that cohabitation before marriage is wrong have their scores multiplied by $e^{0.208066} \approx 1.2313$, showing that openness to different family and household structures may be linked to awareness of gender, sexual, and romantic minorities.

Table 6. Poisson Regression on Gender and Sexual Orientation Section

Effect	Estimate
Intercept	1.493302*
kina_plat	-0.096332*
att_cohab	0.208066*
att_cohab	0.136577*
att_cohab	0.014637
srep_moth	0.117150*

*significant at 0.05 level of significance

There were no significant determinants for sexual mechanisms and knowledge of HIV at $\alpha = 0.05$. This means that scores in these sections do not depend on the independent variables in this study.

3.4 Logistic regression

Backward elimination was also utilized for logistic regression. The indicated odds ratios are the quotients of the odds of "success" (high literacy) over the odds of "failure" (low literacy). Exception is in the reproductive health section where the assignment of "success" was reversed, since the majority of the respondents failed in this section.

Among the significant predictors of kno_tot, kina_plat has a negative coefficient and an odds ratio less than 1, suggesting a small difference in odds. This indicates that a student who experienced platonic attraction has an odds of having a high level of literacy that is 0.287186 times lower than that of a student who experienced a different kind of attraction, holding other factors constant. The same applies to roma_many (attracted to more than one gender) and

shs_stem (STEM strand). However, eth_chi has a positive coefficient and an odds ratio greater than 1, suggesting that the odds of a student, whose ethnicity is Chinese, having a high level of literacy is between 2 to 3 times higher than that of a student who has a different ethnicity, with other factors held constant. The same applies to mrel_tea and srep_moth.

Table 7. Logistic Regression on total Literacy Scores

Variables	Estimates	Odds Ratios
roma_many	-0.853256*	0.181498
eth_chi	0.458491*	2.501730
shs_stem	-0.386135*	0.461963
mrel_tea	0.592494*	3.270647
srep_moth	0.661503*	3.754689
kina_plat	-0.623812*	0.287186

*significant at 0.05 level of significance

Among the significant predictors of kno_sex, the variable shs_stem has a negative coefficient and an odds ratio less than 1, which indicates that the odds of a STEM student having high level of literacy is 0.542669 lower than a student with a different strand, all other things being the same. However, eth_fil has a positive coefficient and an odds ratio more than 1, with students whose ethnicity is Filipino having higher literacy. The same applies to eth_chi and mrel_tea.

Table 8. Logistic Regression on Sexual Mechanisms Section

Variables	Estimates	Odds Ratios
shs_stem	-0.305628*	0.542669
eth_fil	0.594238*	3.282074
mrel_tea	0.942031*	6.580176
eth_chi	0.418212*	2.308101

*significant at 0.05 level of significance

Meanwhile, kno_hivs did not have any significant predictors.

Among the significant predictors of kno_cont, kina_alt has a negative coefficient and an odds ratio less than 1, which indicates that a student who experienced alterous attraction have an odds of having low level of literacy that is 0.368482 lower than a student who experienced a different kind of attraction, all other things being the same. However, mrep_moth has a positive coefficient and an odds ratio more than 1, in favor of students whose mothers are their primary source of information on reproductive systems. The same applies to form_sem (formally received sexual education in a seminar).



Table 9. Logistic Regression on Reproductive Health Section

Variables	Estimates	Odds Ratios
mrep_moth	0.635923*	3.567431
form_sem	0.353902*	2.029528
kina_alt	-0.499181*	0.368482

*significant at 0.05 level of significance

Among the significant predictors of kno_lgbt, the variable jhs_public has a negative coefficient and an odds ratio less than 1, which indicates that the odds of a student who attended a public school prior to transferring to DLSU having a high level of literacy is lower by approximately 0.171402 than a student who attended a different type of school, with other factors held constant. The same applies to shs_stem, kina_plat, and kina_sex (experienced sexual attraction). However, students whose preferred source of information on reproductive systems is their father (pref_fath) and whose primary sources of information on reproductive systems are friends (mrep_frnd) have higher literacy, as these variables have a positive coefficient and an odds ratio more than 1. For pin_nore, which is a continuous predictor, every additional sibling whom a student has results in a multiplicative impact of e0.423021 (1.52657) in the odds of having a high level of literacy.

Table 10. Logistic Regression on Gender and Sexual Orientation Section

Variables	Estimates	Odds Ratios
kina_plat	-0.882578*	0.171160
pref_fath	0.946681*	6.641655
shs_stem	-0.426223*	0.426371
pin_nore	0.423021*	1.526566
jhs_public	-0.881872*	0.171402
mrep_frnd	0.832540*	5.286097
kina_sex	-0.642224*	0.276803
srel_avm	0.830327*	5.262749

*significant at 0.05 level of significance

4. CONCLUSIONS

The educational and moral environment of the SHS students in school and at home greatly influence their sexual literacy. It was found that having teachers and parents, and being able to access multimedia information positively influence their sexual literacy objective exam score. Although results were positive, the education of these students may still be developed and improved as the majority of them failed the reproductive health section. More in-depth discussions must be done and a stronger feeling of trust and comfort must be established between

these students and those in authority to widen their understanding of sexual and reproductive health.

5. ACKNOWLEDGMENTS

Foremost, we would like to express our sincere gratitude to our research adviser, Mr. Angelo Alberto, for his patience and knowledge. His continuous guidance and encouragement helped us immensely in writing this paper.

We would also like to thank the defense panelists, Ms. Shirlee Ocampo, Mr. Karl Collado, and Ms. Regina Tresvalles, for their insightful comments and challenging questions.

Last, but not the least, we would like to thank our families for their love, prayers, care, and sacrifices for educating and preparing us for our future. We would also like to thank our friends for supporting us mentally and spiritually throughout this research.

6. REFERENCES

Adeomi, A., Adeoye, O., Asekun-Olarinmoye, E., Abodunrin, O., Olugbenga-bello, A., & Sabageh, Olukemi. (2014). Evaluation of the effectiveness of peer education in improving HIV knowledge, attitude, and sexual behaviours among in-school adolescents in Osun State, Nigeria. *AIDS research and treatment*. <https://doi.org/10.1155/2014/131756>

Alexander, J. (2008). *Literacy, sexuality, pedagogy: Theory and practice for composition studies*. Utah State University Press. https://digitalcommons.usu.edu/cgi/viewcontent.cgi?article=1024&context=usupress_pubs

Alzate, M. M., Dongarwar, D., Matas, J. L., Salihu, H. M. (2020). The effect of sexual literacy on adolescent pregnancy in Colombia. *Journal of Pediatric and Adolescent Gynecology*, 33(1), 72-82. <https://doi.org/10.1016/j.jpag.2019.09.005>

Commission on Population and Development [POPCOM] (n.d.). POPCOM: Number of girls 10-14 y/o who give birth continue to rise. <http://popcom.gov.ph/popcom-number-of-girls-10-14-y-o-who-give-birth-continue-to-rise/>

Dabiri, F., Hajian, S., Ebadi, A., Zayeri, F., & Abedini, S. (2019). Sexual and reproductive health literacy of the youth in Bandar Abbas. *AIMS Medical Science*, 6(4), 318-325. <https://doi.org/10.3934/medsci.2019.4.318>

Demographic Research and Development Foundation, Inc. & University of the Philippines Population Institute (2016). *The 2013 young adult fertility and sexuality study in the Philippines*. Quezon City: Demographic Research and Development Foundation, Inc. and University of the Philippines Population Institute



- Department of Health. (2019). HIV/AIDS & Art Registry Of The Philippines. Retrieved from <https://www.doh.gov.ph/sites/default/files/statistics/HIV-2019-June.pdf>
- Graf, A. S., & Patrick, J. H. (2015). Foundations of long-life sexual literacy. *Health Education*, 115(1), 56-70. <https://doi.org/10.1108/HE-12-2013-0073>
- Government Equalities Studies. (2018, July). National LGBT survey. Retrieved from https://assets.publishing.service.gov.uk/government/uploads/system/uploads/attachment_data/file/721704/LGBT-survey-research-report.pdf
- Hailu, S. T., Mergal, B. B., Nishimwe, D. F., Samson, M., Santos, N. L. (2018). Sex Education from Home and School: Their Influence on Adolescents' Knowledge, Attitude, and Beliefs Toward Sexuality. *Journal of Health Sciences*, 1(1), 68-74.
- Horn, S. S., Peter, C. R., Tasker, T. B., & Sullivan, S. (2013). Moving past assumptions: Recognizing parents as allies in promoting the sexual literacies of adolescents through a university-community collaboration. *Community Literacy Journal*, 8(1), 71-90. <https://doi.org/10.1353/clj.2013.0023>
- Jones, S., & Norton, B. (2007). On the limits of sexual health literacy: Insights from Ugandan schoolgirls. *Diaspora, Indigenous, and Minority Education*, 1(4), 285-305. <https://doi.org/10.1080/15595690701563998>
- Mitchell, A., Patrick, K., Heywood, W., Blackman, P., & Pitts, M. (2014). 5th national survey of Australian secondary students and sexual health 2013. Australian Research Centre in Sex, Health, and Society. https://yeah.org.au/wp-content/uploads/2014/10/31631-ARCSHS_NSASSSH_FINAL-A-3.pdf
- Moore A., Reynolds P. (2017). Sexual literacy. *Studies in Childhood and Youth*. 197-224. https://doi.org/10.1057/978-1-137-52497-3_9
- Needham, H. E., Wiemann, C. M., Tortolero, S. R., Chacko, M. R. (2010). Relationship between health literacy, reading comprehension, and risk for sexually transmitted infections in young women. *Journal of Adolescent Health*, 46(5), 506-508. <https://doi.org/10.1016/j.jadohealth.2009.11.195>
- O'Hara, R. E., Gibbons, F. X., Gerrard, M., Li, Z., & Sargent, J. D. (2012). Greater exposure to sexual content in popular movies predicts earlier sexual debut and increased sexual risk taking. *Psychological Science*, 23(9), 984-993. <https://dx.doi.org/10.1177%2F0956797611435529>
- Philippine Statistics Authority. (2018, June 6). Nine Percent of Filipinos Aged 6 to 24 years are Out of School (Results from the 2017 Annual Poverty Indicators Survey). Retrieved from <https://psa.gov.ph/content/nine-percent-filipinos-aged-6-24-years-are-out-school-results-2017-annual-poverty-indicators>
- Sexual Literacy. (n.d.). Why Sexual Literacy. Retrieved from <http://www.sexual-literacy.com/why-sexual-literacy>
- Shtarkshall, R. A., Santelli, J. S., & Hirsch, J. S. (2007). Sex education and sexual socialization: Roles for educators and parents. *Perspectives on Sexual and Reproductive Health*, 39(2), 116-119. <https://doi.org/10.1363/3911607>
- Simpson Jr, S., Clifford, C., Ross, K., Sefton, N., Owen, L., Blizzard, L., & Turner, R. (2015). Sexual health literacy of the student population of the University of Tasmania: Results of the RUSSL Study. *Sexual Health*, 12(3), 207-216. <https://doi.org/10.1071/SH14223>
- Sørensen, K., Pelikan, J. M., Röthlin, F., Ganahl, K., Slonska, Z., Doyle, G., Fullam, J., Kondilis, B., Agraftotis, D., Uiters, E., Falcon, M., Mensing, M., Tchamov, K., van den Broucke, S., Brand, H., & HLS-EU Consortium (2015). Health literacy in Europe: comparative results of the European health literacy survey (HLS-EU). *European journal of public health*, 25(6), 1053-1058. <https://doi.org/10.1093/eurpub/ckv043>
- United Nations Development Programme & United States Agency for International Development (2014). Being LGBT in Asia: The Philippines Country Report. https://www.undp.org/content/dam/philippines/docs/Governance/Philippines%20Report_Final.pdf
- Vongxay, V., Albers, F., Thongmixay, S., Thongsombath, M., Broerse, J. E., Sychareun, V., & Essink, D. (2019). Sexual and health literacy of school adolescents in Lao PDR. *PloS One*, 14(1), e0209675. <https://doi.org/10.1371/journal.pone.0209675>
- Westheimer, R. (2020, February 20). Sexual literacy. Encyclopedia.com. <https://www.encyclopedia.com/social-sciences/encyclopedias-almanacs-transcripts-and-maps/sexual-literacy>
- World Health Organization. (2013, November 1). The Philippines passes Reproductive Health Law. Retrieved from https://www.who.int/pmnch/media/news/2013/20130107_philippines_reproductive_health_law/



Listening to Silence: An Insight into the Lives of the Deaf in Baguio City

Maria Jose Carina T. Albayalde, Aleck Donnell L. Angeles, Gian Angelo U. Reyes , Maria Teresa Antonella T. Santillan and Toni Cameron Y. So
Berkeley School, Baguio City

Abstract: Oftentimes, people describe the Deaf as unfortunate and pitiful. However, this is clearly not how they view themselves. This study’s objective is to bring awareness to the lives and struggles of the Deaf community as well as see how others, namely parents and students, perceive them in the present. To achieve this, 3 research questions were formulated: “What are the special skills and abilities of the Deaf?”, “How do Deaf individuals want to be treated by the general population?”, and “How do people feel about their interactions with the Deaf?” By using an inductive thematic analysis, this phenomenological qualitative study concluded that the Deaf excel in the area of arts (culinary, visual, and performing) and sports. This could be linked to a gain connected to Cross-Modal Neuroplasticity. The Deaf also explained that they do not want to be “fixed.” They simply want to be accepted and treated fairly. Still, they would appreciate it if others physically assist them in activities that are difficult for them due to their impairment. As for the perception of others, it was shown that parents of the Deaf had larger numbers of pessimistic initial reactions than hearing students. Stress levels are higher for parents as they have to consider the communication, financial support, and the upbringing of their Deaf children. It is worthwhile to note that other respondents viewed the Deaf as abled, skilled, and talented in certain fields. They were familiar and comfortable around the Deaf as they accepted them for who they are.

Key Words: deaf; Baguio City, abilities; perception; treatment

1. INTRODUCTION

“Blindness separates people from things; deafness separates people from people.” -Hellen Keller

Deafness refers to an individual who cannot hear and understand any sound from their environment. If a person struggles to hear sounds from 20 to 20,000 Hz, they may have a case of hearing loss. Additionally, deafness is usually categorized under profound hearing loss (World Health Organization, 2020). Typically a person with congenital deafness loses verbal communication and hearing ability. Notedly, we use uppercase Deaf when referring to people who share Deaf language and culture, while we use lowercase deaf to refer to the audiological condition itself (Padden and Humphries, 1998).

In the year 2000, the Philippine Statistics Authority conducted a Census of Population and Housing. Data related to the Deaf communities are shown below:

City	Population with Hearing Problems	Total Deafness	Partial Deafness	Hard of Hearing
Cebu City	4,914	1,099	1,905	1,910
Quezon City	2,425	695	679	1,051
Davao City	1,400	442	467	491
Baguio City	374	96	136	142

Based on Census Data (National Statistics Office, 2000).

The Deaf community is a minority in Baguio’s population. This could be a reason why little Deaf studies are conducted in the city. Thus, it is the researchers’ goal to create a localized

Deaf study to find out the Deaf’s skills, how they want to be treated, and how others perceive them.

Three research questions guided the study:

1. What are the special skills and abilities of the Deaf?
2. How do Deaf individuals want to be treated by the general population?
3. How do people feel about their interactions with the Deaf?



The abilities and skills of the Deaf community

Perception Skills

Deafness does not stop the Deaf community from excelling in certain areas of senses. Interestingly, individuals with hearing impairments perform better on various perceptual tasks (Parasnis, 1983; Bavelier et al., 2006; Mitchell and Maslin, 2007).

William Levy compared a battery and five wires to the brain and the senses of the body. He concluded that disability is similar to the total energy of that “battery” being distributed to only four “wires.” One sense is not getting any development, therefore the others perform exceptionally better. This occurrence of transforming brain power deprived of stimulus to help support and augment other senses is known as Cross-Modal Neuroplasticity (Braun, 2016).

Moreover, according to a research conducted by Cordina, et al. (2010), the Deaf react quicker to objects at the edge of their visual field than hearing people. Hence, they could be more proficient in jobs which depend on the ability to see a wide area of activities (University of Sheffield, 2010). This is advantageous in sports as interrelated vision skills affect how well someone plays.

How the Deaf want to be treated by the public

Kyle and Pullen (1988) explained that the essential basis for interaction between hearing and non-hearing people is that society says Deaf people need to be helped while Deaf culture says it needs to be understood with respect.

To add to that, the Deaf do not consider their hearing disability as a huge issue for them (Lane et al., 1996). The real disability is society’s hesitance and unwillingness to accommodate the needs of the Deaf such as proper captioning, interpreting services, and alternative ways to access communication.

Interactions between the Deaf and hearing people

Family

Hearing parents with hearing impaired children face a number of unique challenges that result in increased stress (Pipp-Siegel et al., 2002; Hintermair, 2006 ; Quittner et al., 2010). These include issues with hearing technology, communication problems, educational challenges, and issues with finances and the safety of their children. Because of these, parenting stress comes to light. It occurs when parents’ perceptions of the obligations of parenting outstrip their resources (Abidin, 1992 and

Deater-Deckard, 1998).

Furthermore, Karten (2015) stated that the emotive behavior of parents who raise a special needs child is similar to the grief and mourning process — shock, denial, guilt, depression, and acceptance.

Nevertheless, accepting the child because of their disability may be a positive ‘stage’ of family adjustment (Blacher, 1984) as it leads to positive familial results like becoming closer as a family, developing new family priorities, adopting positive meaning of the child’s disability, and gaining a re-established sense of purpose for the parents.

Students

LaBelle et al. (2013) concluded that the negative treatment of people comes from “outgroup” perception. They stated that one or both sides of communication act based on their perception of the other side’s “group” rather than the individual. If the perceived group is not the same as one’s own group, the other person is perceived as being in an “outgroup”. In their study, people perceived the hearing impaired group negatively as others felt extreme outgroup perception. From this, it is clear that people still have negative perceptions of Deaf individuals due to limited exposure to them.

Hankins (2015) proved that the majority of hearing people lack knowledge about Deaf culture and how to interact with them. They acknowledge that there is a need to understand Deaf culture better. By interacting more with Deaf people, the hearing develop a more positive perception of those with hearing impairments (Most et al., 1999).

Additionally, Stinson and Liu (1999) discovered that problems brought upon by the difference in communication such as frustration, fear, unfamiliarity, misunderstanding, and aversion to outgroups in general were the foundations for hearing students’ negative attitudes towards the non-hearing.

2. METHODOLOGY

The researchers utilized a phenomenological qualitative study to interpret the experiences and abilities of the Deaf. Also, an inductive thematic analysis was used to see possible patterns in the respondents’ answers.

Two populations were considered. First were individuals with congenital deafness, since childhood health problems could cause variations in personality (Caspi et al., 2005 and Eisenberg et al., 2014). These variations stay with them as they age. The second population were the parents and classmates of the Deaf respondents. They gave a glimpse of society’s treatment towards the Deaf.

Online interview guides created on Google Forms were utilized because of the study’s phenomenological nature. Each group had different



sets of interview questions. The Deaf's questions focused on their abilities and feelings, while the hearings' questions focused on how they perceived and treated people with deafness.

The quarantine imposed made it difficult to reach out to participants. Thus, the snowball sampling method was used.

3. RESULTS AND DISCUSSION

Table 1. Master Themes from Deaf Respondent Interview Excerpts Regarding their Special Skills and Abilities

Master Themes	Corresponding Codes	Exemplar Quotes
Arts	Culinary Arts	"I love to cook."
	Performing Arts	"Singing"
		"Artist and dance"
		"Dancing"
Visual Arts	"He loves to dance and play the PS4."	
	"Drawing"	
	"Artist and dance"	
Sports	E-Sports	"He loves to dance and play the PS4."
	Physical Sports	"Playing volleyball"

In relation to previous literature, Table 1 shows that the Deaf excel in the arts and sports, which can be attributed to Cross-Modal Neuroplasticity (Braun, 2016).

Table 2. Master Themes from Deaf Respondent Interview Excerpts Regarding How They Want to be Treated by the General Public

Master Themes	Corresponding Codes	Exemplar Quotes
Physical Aid	Physical help	"Reduce background noise as much as possible." "Helper"
Positive Mental Attitude	Awareness	"They should aware that the person is hearing impaired, by the moment they saw that person start to communicate by means of sign language." "First is for them to be aware of the condition of the child. Secondly, they have to accept the child for who he is." "first to know what things coming from, example there feelings..."
		"Through promoting the human rights of persons with disabilities"
		"Show them respect, love them who they are, show them that they're also human"
	Acceptance	"Make them that they are not other's" "First is for them to be aware of the condition of the child. Secondly, they have to accept the child for who he is." "Through promoting the human rights of persons with disabilities"

This exemplifies how the Deaf do not want to be "fixed" because they do not view their disability negatively. The table emphasizes that the Deaf just want a positive attitude from others through acceptance and awareness of their disability.

Nevertheless, the Deaf still want physical help from others as they are more sensitive to things like background noise.

Table 3. Master Themes from Non-Hearing Impaired Parent Respondent Interview Excerpts Regarding Their Initial Reactions to Having a Hearing Impaired Child

Master Themes	Corresponding Codes	Exemplar Quotes
Positive Initial Reaction	Acceptance	"I accepted." "We chose to adopt a hearing impaired child. It was a deliberate choice."
		Negative Initial Reaction
Negative Initial Reaction	Psychological Shock	"can't believe" "Shock and confused, I was worried on how can we enroll him ti school, and how can we communicate with him well."
	Anxiety	"can't believe" "Shock and confused, I was worried on how can we enroll him ti school, and how can we communicate with him well."
	Sadness	"Nalungkot...uNang pumasok sa isip ko na hnd na sya mabubuhay ng normal.Pakiramdam ko nuon ay pinagsakluban ako ng langit at lupa...naawa ako sa anak ko."

As mentioned by Karten (2015), parents did feel shock, guilt, and later on acceptance towards their children. Similar to past findings, educational and communicational concerns were evident in the respondents' answers. Although most reactions were negative, there were parents who immediately accepted their child's deafness, which leads to positive familial results.

Table 4. Master Themes from Non-Hearing Impaired Parent Respondent Interview Excerpts Regarding How They Feel as a Parent of a Deaf Individual

Master Themes	Corresponding Codes	Exemplar Quotes
Optimistic Feeling	Pride	"Proud. Our daughter is bilingual (sign language and English). She is very resilient and observant and despite many challenges she is amazing and is thriving."
Pessimistic Feeling	Sadness	"Sometimes sad, sometimes irritated specially when there's some other kids who try to bully him." "Malungkot syempre.i feel sorry for my daughter being deaf."
	Irritation towards others	"Sometimes sad, sometimes irritated specially when there's some other kids who try to bully him."
	Pity	"Malungkot syempre.i feel sorry for my daughter being deaf."

Table 4 illustrates that parents mostly feel pessimistic emotions. Parents often feel these since they see their children undergo hardships brought upon by deafness. Irritation is also mentioned as a Deaf respondent experienced bullying. This situation is a portrayal of LaBelle et al's (2013) "outgroup" perception.

Still, a sense of pride emerged from a respondent of the study as their daughter gained more



skills despite her disability. Generally, parents still see the good sides of their children's situation.

Table 5. Master Themes from Hearing Student Respondent Interview Excerpts Regarding How They Feel Towards a Deaf Individual

Master Themes	Corresponding Codes	Exemplar Quotes
Optimistic Feeling	Engaged	"I feel engaged because they are communicating in a whole different way. This also sparked my interest in learning sign language for me to at least know the basics on how to communicate with them."
	Comfortable	"I feel the same for everyone even if they are disabled. They do their best to adjust in everyday life and that earns my respect. They're still humans after all." "I feel normal, i dont think there is a distinct difference from talking to other people. It was a bit strange the first time I have ever met a deaf person because I proceeded to say "hi" then a friend called me stupid because she obviously couldn't hear me and then i apologized by saying "sorry". After this my friend called me "retarded"." "It's just like communicating with a normal person. However, there are certain adjustments (e.g. sign language, hearing aid, etc.) that are done to communicate with them." "Comfortable lang ako." "I feel comfortable interacting with them."
Pessimistic Feeling	Challenged	"Quite challenging because you need to action out what you want to say to him/her." "I honestly sometimes feel nervous, especially when the people I interact with is the same age I am. The least that I want to happen is to make them uncomfortable whenever they're around me."

It is highlighted that most students already feel comfortable with the Deaf. It was almost as if they were communicating with a hearing individual. Others felt motivated to even learn some basic sign language for them.

Still, some felt pessimistic. As Stinson and Liu (1999) mentioned, these were brought upon by challenges given by the communication difference.

Table 6. Master Themes from Hearing Student Respondent Interview Excerpts Regarding How They Perceive Deaf Individuals

Master Themes	Corresponding Codes	Exemplar Quotes
Skillfulness	Talented	"The one thing I've seen and observed from them is their talent in the field of arts and dance. These talents help them overcome their disability and make them showcase what they have." "They are harmless, kind, and actually very creative or possess a hidden talent such as being artistically inclined."
	Able	"The way i perceived the situation of a hearing impaired individuals, I see them as a more hardworking person than the normal individuals because of their dissability." "I deem them as perfectly able people. They are still able to function in the society and go on with their everyday lives despite their condition, and I think that's what matters." "I think my perception for anyone who has hearing impairment or for anyone who may have a disability would not be different from my perception of those who are deemed "normal". I acknowledge their disability and the problems they may be facing but I would never feel pity about them. I think it is completely disrespectful to think that they need our pity. I strongly believe that any deaf person can be as capable as anybody, they can do everything and anything that "normal" people can do with the exception of hearing sounds." "I perceive them as people with disability, therefore they require a different approach when it comes to communication; but when it comes to socializing, I treat them as normal people who enjoys company as well."
Familiarity	Familiarity with the Hearing Impaired	"Yung mga hindi makarinig o mahina ang pandinig." "AWARE naman akong impaired ang isang tao, using my senses of sight or minsan instinct." "I perceive them as people with disability, therefore they require a different approach when it comes to communication; but when it comes to socializing, I treat them as normal people who enjoys company as well."
Good Conduct	Moral	"I perceive them as kind and humble individuals." "They are harmless, kind, and actually very creative or posseses a hidden talent such as being artistically inclined."

It is seen above that the majority of hearing students perceive the Deaf as skillful people. More specifically, hearing people noticed their talents and abilities despite the hindrances brought upon by deafness. They also took note of the good conduct of the Deaf such as their morals and hard work. Because the student respondents have experienced working with the Deaf, they have shared their positive perceptions such as familiarity and acceptance. They even acknowledged the physical and communication difference between them and their non-hearing peers. This proved Most et al. 's (1999) study that shows more interaction with the non-hearing gave others a



more positive view of the Deaf.

4. CONCLUSIONS

The following points illustrate and synthesize the study's key findings.

Being physically different does not stop the Deaf community from living life like hearing individuals. Compared to others, their perception skills—gained through Cross-Modal Neuroplasticity—is better. Lastly, it was revealed that the non-hearing have great skill in the field of culinary, performing, and visual arts.

The Deaf want to be treated fairly, not “fixed.” They wish others to understand that they are happy with themselves. They value acceptance and awareness from people the most.

Most first impressions towards the Deaf are negative. Notably, parents of the Deaf had more pessimistic initial reactions than hearing students. They take in more stress because they have to worry about health and communication aside from raising and supporting their child. Nonetheless, respondents have viewed Deaf individuals as abled, skilled, and talented — interpreted as a sign of acceptance and familiarity towards Deaf culture. People have a better perception of people with hearing impairments if they have a proper understanding of deafness and more exposure to the non-hearing community.

The researchers hope to inspire future researchers to further initiate studies that have the Deaf community as respondents. These are their recommendations:

Future researchers may want to work with those who have mild, moderate, or severe deafness. Data, answers, and experience may vary between individuals with different levels of hearing impairments.

Respondents were only chosen because they have congenital deafness, regardless of its cause. Others can create studies which show if there is a difference between the answers of Deaf individuals, if the causes of their hearing loss vary.

Future researchers may want to work with more groups such as human resource managers, public transportation drivers, and many more in order to have a view of how the Deaf are treated in the workplace or everyday life.

5. ACKNOWLEDGMENTS

This paper would have not been what it is in the present had it not been for these individuals who in one way or another gave their valuable time and contributed in the preparation and completion of this research.

To Berkeley School, thank you very much for being a learning institution that has allowed us to

constantly explore and learn things. Without you, we would not be smarter than we were yesterday.

To Sir Alfonso B. Astudillo III, thank you for constantly guiding us throughout the process of writing this research paper. We will never forget how you gave us your precious time in order to answer our never-ending questions from the morning all the way to the evening. The wisdom that you shared with us will continually help us become better researchers, students, and people.

To our families, thank you for your constant support and love. It is because of you that we work hard. We hope that we made you proud.

Lastly, we would like to thank the Lord. Without Him, we would not have the knowledge and opportunity to become writers of this particular topic. He has always supported our academic pursuits. Most importantly, He provided us with the strength to finish writing. Because of that strength, no amount of mental and emotional breakdowns could stop us from completing our paper.

6. REFERENCES

- Braun A. (2016) The sensory compensation hypothesis. In: *The Speaker Identification Ability of Blind and Sighted Listeners*. Springer VS, Wiesbaden. https://doi.org/10.1007/978-3-658-15198-0_1
- Karten, T. J. (2015). *Inclusion strategies that work! Research-based methods for the classroom* (3rd ed.). Corwin.
- Lane, H. L., Hoffmeister, R., & Bahan, B. J. (1996). *A journey into the deaf-world*. Dawn Sign Press.
- Padden, C., & Humphries, T. L. (1998). *Deaf in America: Voices from a culture*. Cambridge: Harvard University Press
- Abidin, R. R. (1992). The determinants of parenting behavior. *Journal of Clinical Child Psychology*, 21(4), 407–412. https://doi.org/10.1207/s15374424jccp2104_12
- Barker, D. H., Quittner, A. L., Cruz, I., Snell, C., Grimley, M. E., Botteri, M., & CDaCI Investigative Team. (2010). Parenting Stress Among Parents of Deaf and Hearing Children: Associations with Language Delays and Behavior Problems. *Parenting*, 10(2), 136–155. <https://doi.org/10.1080/15295190903212851>
- Bavelier, D., Dye, M. W. G., & Hauser, P. C. (2006). Do deaf individuals see better? *Trends in Cognitive Sciences*, 10(11), 512–518. <https://doi.org/10.1016/j.tics.2006.09.006>
- Blacher, J. (1984). Sequential stages of parental adjustment to the birth of a child with handicaps: Fact or artifact? *Mental Retardation*, 22(2), 55–68
- Caspi, A., Roberts, B. W., & Shiner, R. L. (2005). Personality development: Stability and change. *Annual Review of Psychology*, 56(1), 453–484.



- <https://doi.org/10.1146/annurev.psych.55.090902.141913>
- Codina, C., Buckley, D., Port, M., & Pascalis, O. (2010). Deaf and hearing children: a comparison of peripheral vision development. *Developmental Science*, 14(4), 725–737. <https://doi.org/10.1111/j.1467-7687.2010.01017.x>
- Deater-Deckard, K. (1998). Parenting stress and child adjustment: Some old hypotheses and new questions. *Clinical Psychology: Science and Practice*, 5, 314–332.
- Eisenberg L. S., et al. (2014). Predicting behavior problems in deaf and hearing children: The influences of language, attention, and parent-child communication. *Developmental Psychopathology*, 21, 373 – 392 . DOI: 10.1017/S0954579409000212
- Hintermair M. (2006). Parental resources, parental stress, and socioemotional development of deaf and hard of hearing children . *Journal of Deaf Studies and Deaf Education*, 11 , 493 – 513 . <https://doi.org/10.1093/deafed/enl005>
- Kyle, J. G., & Pullen, G. (1988). Cultures in contact: Deaf and hearing people. *Disability, Handicap & Society*, 3(1), 49–61. <https://doi.org/https://doi.org/10.1080/02674648866780041>
- LaBelle, S., Booth-Butterfield, M., & Rittenour, C. E. (2013). Attitudes toward profoundly hearing impaired and deaf individuals: Links with intergroup anxiety, social dominance orientation, and contact. *Western Journal of Communication*, 77(4), 489–506. <https://doi.org/10.1080/10570314.2013.77901>
- Mitchell, T., & Maslin, M. T. (2007). How vision matters for individuals with hearing loss. *International Journal of Audiology*, 46(9), 500–511. <https://doi.org/10.1080/14992020701383050>
- Most, T., Weisel, A., & Tur-Kaspa, H. (1999). Contact with students with hearing impairments and the evaluation of speech intelligibility and personal qualities. *The Journal of Special Education*, 33(2), 103–111. <https://doi.org/10.1177/002246699903300204>
- Parasnis, I. (1983). Visual perceptual skills and deafness: A research review. *Journal of the Academy of Rehabilitative Audiology*, 16,148–160.
- Pipp-Siegel, S., Sedey, A. L., & Yoshinaga-Itano, C. (2002). Predictors of parental stress in mothers of young children with hearing loss. *Journal of Deaf Studies and Deaf Education*, 7(1), 1–17. <https://doi.org/10.1093/deafed/7.1.1>
- Stinson, M., & Liu, Y. (1999). Participation of deaf and hard-of hearing students in classes with hearing students. *Journal of Deaf Studies and Deaf Education*, 4, 191–202. <https://doi.org/10.1093/deafed/4.3.191>
- Hankins, R. C. (2015). (thesis). Social interaction between deaf and hearing people. Retrieved from <https://core.ac.uk/download/pdf/148695046.pdf>
- National Statistics Office (NSO) . (2000). 2000 census of population and housing Baguio City. Philippine Statistics Authority.
- National Statistics Office (NSO) . (2000). 2000 Census of population and housing Cebu City. Philippine Statistics Authority.
- National Statistics Office (NSO) . (2000). 2000 Census of population and housing Davao City. Philippine Statistics Authority.
- National Statistics Office (NSO) . (2000). 2000 Census of population and housing Quezon City. Philippine Statistics Authority.
- University of Sheffield. (2010, November 11). Deaf adults see better than hearing people, new study finds. ScienceDaily. www.sciencedaily.com/releases/2010/11/101110205051.htm
- World Health Organization. (2020, March 1). Deafness and hearing loss. World Health Organization. <https://www.who.int/news-room/fact-sheets/detail/deafness-and-hearing-loss>



Do apples fall not far from the tree?: An Exploratory research on the influence of parents to their children's attitudes toward the LGBTQ+ community

Gwenevie Q. Bayaua, Franz Joseph B. Beltran,
and Rei Czelle M. Rodrigo
De La Salle University Integrated School, Manila

Abstract: The parent-child interaction is the first social connection a child would engage within their life. A part of this relationship is how parents develop their child in the physical, mental, and emotional aspects. These varying aspects then extend to the attitudes and perceptions the child may have toward different aspects of life, including social issues such as those concerning the LGBTQ+ community. The following study seeks to explore the influence of parents to their children's attitudes towards the LGBTQ+ community. It is in this context that this study is proposed where the assumption is that the parents' attitude towards queer identity and community will be shared with their child. The study had gathered its data from 18 self-identified cisgender and heterosexual De La Salle University senior high-school adolescents in Metro Manila who are at or above the age of 18. Contrary to the research assumption, it was found that majority of the respondents had a positive perception of the LGBTQ+ community and its members despite some parents having homophobic or generally negative perceptions and tendencies towards the community. This implies that adolescents possess a certain level of agency when it comes to relating and empathizing with minority communities, particularly that of the LGBTQ+ community. Given these results, the researchers of the study recommend that future explorations on the subject delve into studying the thought process of those below the age of 18, particularly those who are 12-17 years old, in order to gauge the potential difference and similarity in perspective.

Key Words: queer, LGBT, family, relationship, attitude

1. INTRODUCTION

The family is the most fundamental and simplest unit of society. More often than not, the parents are the first sources of information for a child, setting up the cornerstones of a child's rudimentary education. Depending on the quality of the education that these parents have given their children, in a digital age where information on almost any topic under the sun is available to be perused by the general public, it may be up to the child and external educational institutions to fill in the blanks or completely revise these teachings. The article aims to tackle the impacts of the knowledge gained, particularly on the LGBTQ+ community, of a child from their parents and how the child utilized their parent's teachings and perceptions to mold their own perception of the LGBTQ+ community. The researchers of the article attempts to establish their position on closing the gap on the scholarly pursuits of LGBTQ+ studies based in the Philippines and advocates for a more substantial and concrete pedagogy on queer literacy in the country.

2. METHODOLOGY

The researchers commenced the data gathering process with a preliminary survey. The survey assessed the quality of parent-child relationship among 188 respondents ranging from the ages of 15-20 years old from a population of 1,143 De La Salle University-Manila Integrated School students. The researchers collated the gathered data and created a tabulation to determine which students met the set standards. Based on the relative average calculated from the responses, the high, middle, and low levels of parent-child relationship were established where six (6) self-identified heterosexuals aged 17-19 were chosen for the interview. The prospective subjects were then contacted through email with the provision of additional consent forms and interview schedules. From there, the researchers conducted 30-minute to one-hour one-on-one semi-structured interviews for a total of 13 interviewees. The said interviews were conducted with the aid of interview guides that assessed four key parts: (1) parental attitudes towards the LGBTQ+, (2) parent-child relationship, (3) child's queer literacy, and (4)



personal attitudes towards the LGBTQ+.

The interview transcripts then underwent the processes of coding, assimilation of themes, and definition of themes. The research proponents first highlighted several key points or codes that they deemed useful in relation to answering the questions of the study. From the created codes, themes were formulated from the patterns that have emerged. In this stage, the transcripts were reviewed once again to assess the consistency of the themes in relation to the declarations of the respondents. Finally, the meanings of the themes were defined relative to the whole of the informants' statements on the basis of the researchers' obtained knowledge from various literary sources cited in their review of related literature (RRL).

3. RESULTS AND DISCUSSION

Parent-Child Relationships and Parental Attitudes

In the study, seven out of the thirteen informants have shown a close relationship with their parents. This closeness was accompanied by a sense of open-mindedness when it came to understanding personal, political, or social discourse. The respondents shared that their parents often encouraged values of open communication, transparency, and an exchange of ideas. Communication was frequent, and both parents and children sought each other out for companionship, comfort, and advice. Among the seven, four respondents had reported that their parents held positive attitudes towards the LGBTQ+ community. The parents expressed openness to discuss LGBTQ+ related topics and issues, where they all shared positive and welcoming perceptions. This was shown through their conversations and exchanges. This behavior was also exhibited when the parents were around LGBT relatives and peers, where the informants saw that they were welcoming, warm, and friendly.

Two of the seven respondents' parents had ambiguous or tolerant attitudes that were neither fully accepting nor hostile. Their tolerance primarily entails acceptance towards the LGBTQ+ where they are treated with mutual respect to a point of peaceful and non-violent coexistence. The ambiguity of their parents' tolerant attitudes lies in their casual discriminatory or stereotypical behavior. This kind of behavior refers to their casual comments, jokes, and name-calling. One of the respondents recalls her mother, albeit generally tolerant, pertaining to masculine gays as "sayang" or a waste for not adhering to heteronormative standards. For the rest, their parents were said to have passed off jokes ridiculing the members and using terms like "bakla"

or "tomboy" with a negative connotation. Though these remarks were present, they would not be outrightly said to anyone in the LGBT spectrum, rather it is uttered to their children in private.

One had parents who had negative attitudes towards the LGBTQ+. For one of them, the interview found that they saw their LGBTQ+ identity as a cause of their shortcomings although the individuals' negative traits may be unrelated to their sexual orientation, gender identity, and expression (SOGIE).

Six individuals reported a neutral to low quality of the relationship, saying it was "civil" and "fine" to explain their parental relationships. They have explained that communication happens mostly out of necessity, and the parents are the sole party to seek out the other. As a result, the exchange of ideas, from personal advice to political discourse is seldom. One had even mentioned that they perceive parent-child interactions as solely an obligation and inherently takes away from their choices and self-autonomy.

Of the six individuals, two observed the same positive attitude in their parents as those with close bonds. Three had parents with ambiguous and neutral attitudes, while one had a negative perception of the LGBT community. The characterizations of these informants of their parents' attitudes were generally the same as those who had close relationships. On the part of the one informant with parents dismissive of the LGBT community, it was also reported that there were displays of hostility towards members of the community, leading the child to describe their parents' attitudes as "toxic" and "alienated". The researchers have also found that there was a case of selectivity for one of the respondent's parents. According to the said respondent, their parents would only tolerate members who are part of their circle and usually only if they are within their presence.

In developing a child's personality, the influence of parental attitudes is an influential factor (Zunich, 2012). Similarly, a few traits that may be reflected in the child based on the parenting style may be their physical appearance, gender, and temperament. In contrast to this, parent-child relationships with negative connections create more emotional distance between the two parties. When a parent lacks action in certain aspects such as trust, respect, or communication, this may negatively affect the child's behavior and development (Altalib, 2013). Values and beliefs were shown to be attributed to adults' behavior and competence and their capabilities as children educators (Schaefer, 1991). The parent's own set of beliefs towards certain concepts are tailored from their behavior, among other factors. This is then reflected in how these parents molded the development of their children. Evidence is substantial that child development—and accordingly, children's skills—is influenced by family characteristics, such as



parental education, income, and other factors contributing to parental quality (Rindfuss, 1992). Family-related factors contributing to parental quality seem to be particularly important, and it sets up child outcomes based on the quality of other caregiving and learning institutions, such as day-care centers or schools (Pew Research Center, 2015). Grusec and Danylluk (2014) examined how parents changed their behavior as they raised children and how these behaviors impacted a child's development. They mainly concluded that a parent's attitude that can be described with warmth, along with reasonable levels of control, combine to produce positive child outcomes in terms of their attitudes.

Level of awareness on LGBTQ+ concepts and issues

Other than parental attitudes, the researchers also seek to discover whether level of awareness on LGBTQ+ concepts and issues one has plays a significant role in adolescents' outlook on the LGBTQ+ community. This was tested to the informants by presenting different words, phrases, and sentences tied to the LGBTQ+ community and asking them to explain their understanding of it without any supplemental information. Out of all the respondents, 3 individuals showed a low level of such awareness. They were unable to clearly define gender and sexuality. The two individuals also failed to explain the concepts of social constructs, fluidity, and stated that they had no insight on how they perceived the representation of the LGBTQ+ community in mass media. There was a general lack of understanding in the concepts presented. One informant was even avoidant, saying that they did not want to learn queer concepts as they fear it would "make them queer". This informant also called the concept of fluidity and intersectionality as "nonsense."

Two individuals have exhibited a moderate level of such awareness. This meant that while they were familiar with the concepts presented, they were still unable to articulate its clear meaning, such as concepts like intersectionality and fluidity. Expressing a high level of LGBTQ+ awareness, 8 individuals were able to comprehensively explain all of the given concepts with ease. They were also able to add depth to merely explaining the textbook definition of the phrases by connecting them with their personal experiences, insights, and manifestations.

The informants cited different sources of knowledge that have led them to such a level of queer literacy. For individuals with a high level of queer literacy, they have credited their knowledge to topics discussed at school, articles they read on social media, and most importantly, the insights they receive from their peers especially those who identify with the LGBTQ+ community. Liberal and inclusive spaces like

universities also contributed to the high level of literacy. Nine of the informants said that though they learned some queer concepts at home and through their families, this knowledge was lacking and biased toward the attitudes of their parents. This prompted them to look for more sources of knowledge through alternative mediums. The informants who had a moderate to low level of queer literacy were unable to expound as much on their sources of information. They have only gone as far as to cite subject topics and social media.

Sj Miller (2015) coded the level of awareness towards the LGBTQ+ community as "queer literacy" or the ability to view gender and sexuality through a queer lens. In his work, he advocated for expanding knowledge on the LGBTQ+ community with the employment of a Queer Literacy Framework or QLF. According to him, a QLF will help teach students the empowerment of their sexualities and those of their peers. For this, Miller reasoned that gender and sex play significant roles in shaping students' perceptions of themselves and others.

Furthermore, he stated that with the acceptance of sexual diversity, "violence would not prevail." Ergo, conditions that encourage students to self-determine their gender and sexuality are vital in achieving gender and sexuality justice. In essence, this means that a more comprehensive understanding and acceptance of the different LGBTQ+ identities would mean the lessening of gender-related crimes and abuse, leading to gender and sexuality justice. GLAAD's 2016 survey on "Accelerated Acceptance" shows that education, increased knowledge, and consistent dialogue on LGBTQ+ identities and struggle is what leads to lower levels of discomfort towards the queer community, which in turn leads to less discrimination. Queer literacy examines one's knowledge of gender and sex as constructs and fluid concepts, as well as its representation in mass media, and the importance of advocating for its equality.

Adolescent Acceptance

Seven out of 13 informants have a positive attitude towards the LGBTQ+. They have all explicitly expressed their warm acceptance of the LGBTQ+ community. A common theme was that they do not impose othering towards individuals from the said community. Instead, they believe that they should not be treated unfairly based on their SOGIE alone. Given this line of thought, they all share a strong advocacy of equity for the LGBTQ+ to a point where they educate themselves and the people around them. The five informants who have tolerant or ambivalent attitudes towards the LGBTQ+ essentially share the same beliefs with the rest. All of the interviewees have expressed their support over the community in the same ways. However, there



remains to be certain stereotypes and discriminatory characterizations that those with tolerant attitudes adhere to and exhibit. For example, one of the informants have said that they do not wish to fully immerse themselves among LGBTQ+ for it may change their SOGIE by way of influence. Another one has said that they find effeminate attitudes or expressions from males unbearable for being “weird” at some extent. Nonetheless, they claimed to still accept the LGBTQ+, including future children or intimate partners, and believe that they deserve the achievement of equity.

4. CONCLUSIONS

An individual’s childhood encompasses some of their most formative years. And so, for children who have lived said years under the care and influence of their parents, it is no question that their parents hold great responsibility in educating their children. In this day and age where the world is finally beginning to acknowledge the well-deserved rights of marginalized groups like the LGBTQ+ community, it is only fair to adapt to such changes in ideologies.

The researchers’ study has found that the youth are generally more tolerating and positive towards the LGBTQ+ regardless of their parents’ notions. In other words, the results have shown an unpredictability in utilizing parent-child relationships as a sole determinant for adolescents’ behaviors. However, the youth’s queer literacy remains contingent on their parents’ ideologies on the matter. This is because youth with parents who embody negative perceptions and attitudes require more intensive means and methods to gather information on queer knowledge. This conclusion then stands as an indictment of the intensely-lacking (or non-existent, perhaps,) LGBTQ+ positive pedagogy today. There is grave importance in establishing, supplementing, and supporting LGBTQ+ pedagogy founded on the premise of queer objectivity and literacy. As such, the inextricable link between knowledge and attitudes or actions must be utilized to empower the youth towards non-prejudicial and non-discriminatory principles as a means of protecting the LGBTQ+ community and standing as their allies.

5. ACKNOWLEDGMENTS

The researchers would like to express their gratitude to Dr. Madelene Sta. Maria, the adviser from Practical Research 1, for helping them set the foundation for what will be the center of the research. Through Dr. Sta. Maria’s contributions, the study was allowed to gain focus and clarity on a single feasible topic that could be continued by the research. The researchers would also like to thank Dr. Malbarosa for expanding the knowledge on the

philosophical aspects of research and why topics like that of what is being covered, is essential in contributing to a larger body of knowledge in the research and academe of the Philippines, especially in the LGBTQ+ studies, where localized studies are scarce.

Lastly, the researchers would like to thank their mentor, Dr. Melvin Jabar, for helping them ground the objectives and methodology of the research and aiding in the rigorous revisions of the entire manuscript. Dr. Jabar’s contributions to the research are indispensable, with the aid in solidifying the structure and details of the research in its totality.

6. REFERENCES

- Alexander, J. (2008). *Literacy, sexuality, pedagogy: Theory and practice for composition studies*. Logan, Utah: Utah State University Press.
- American Psychological Association (2012). Guidelines for psychological practice with lesbian, gay, and bisexual clients. *Am. Psychol.* 67, 10–42. DOI: 10.1037/a002465
- Arbona, C., & Power, T.G. (2003). Parental attachment, self-esteem, and antisocial behaviors among African American, European American, and Mexican American adolescents. *Journal of Counseling Psychology*, 50, 40–51.
- Azares, J. C. P., Catito, H. M. A., Cifra, S. N. J., & Regadio Jr., C. Q. (2019). *Intersectionality between Gender and Ethnic Identity: The Case of Lesbian and Gay Blaang in Barangay Kablon, Tupi, South Cotabato*
- Bautista, M., Bernardino, R., & Tan, K. (1993). *Bata, Bata, Ano ang Bakla? Isang Pag-aaral ukol sa Pananaw ng batang Filipino hinggil sa mga bakla*. (Master's thesis, De La Salle University, 1993). Manila: De La Salle University.
- Becker, D. “Growing Up in Two Closets: Class and Privilege in the Lesbian and Gay Community.” In S. Raffo (ed.), *Queerly Classed*. Boston: South End Press, 1997.
- Bilodeau, B. L. (2009). *Genderism: Transgender students, binary systems and higher education*. Germany: VDM Verlag
- Bilodeau, B. L., & Renn, K. A. (2005). Analysis of LGBT identity development models and implications for practice. *New Directions for Student Services*, 2005(111), 25–39. DOI: 10.1002/ss.171
- Bird, J. D., LaSala, M. C., Hidalgo, M. A., Kuhns, L. M., & Garofalo, R. (2017). “I had to go to the streets to get love”: Pathways from parental rejection to HIV risk among young gay and bisexual men. *Journal of Homosexuality*, 64(3), 321–342.
- Brown, L. B. “Women and Men, Not-Men and Not-Women, Lesbians and Gays: American Indian Gender Style Alternatives.” In L. B. Brown (ed.), *Two-Spirit People: American Indian Lesbian Women and Gay Men*. New York: Harrington Park Press, 1997.
- Child care and education: quality, availability and parental involvement. (2019, December 31). Retrieved from <https://www.pewsocialtrends.org/2015/12/17/4-child-care-and-education-quality-availability-and-parental-involvement/>
- Coffman, B. K., Coffman, C. L., Marzilli Ericson, K. M. (2016). *The Size of the LGBT*
- Population and the Magnitude of Antigay Sentiment Are Substantially Underestimated. *Management Science*, Vol. 63(10). DOI: 10.3386/w19508.
- D’Amico, E., & Julien, D. (2012). Disclosure of sexual orientation and gay, lesbian, and bisexual youths’ adjustment: Associations with past and current parental acceptance and rejection. *Journal of LGBT Family Studies*, 8(3), 215-242.



- D'Augelli, A. R., Grossman, A. H., & Starks, M. T. (2005). Parents' awareness of lesbian, gay, and bisexual youths' sexual orientation. *Journal of Marriage and Family*, 67(2), 474–482. DOI:10.1111/j.0022-2445.2005.00129.x
- DuMontier, V. L., II (2000). Faith, the Bible, and lesbians, gay men, and bisexuals. In V.
- A.Wall and N. J. Evans (Eds.), *Toward Acceptance: Sexual Orientation Issues on Campus*. Washington, D.C.: American College Personnel Association, 2000.
- Ermisch, J., Jäntti Markus, & Smeeding, T. M. (2012). From parents to children: the intergenerational transmission of advantage. Russell Sage Foundation.
- Fausto-Sterling, A. (2000). TheFiveSexes, Revisited. *The Sciences*, 40(4), 18–23. <https://doi.org/10.1002/j.2326-1951.2000.tb03504.x>
- Fitzsimons, T. (2019, June 24). Many parents struggle to adjust after learning child is gay, study finds. NBCNews.com. Retrieved from <https://www.nbcnews.com/feature/nbc-out/many-parents-struggle-adjust-after-learning-child-gay-study-finds-n1020511>.
- Floyd, F. J., Stein, T. S., Harter, K. S. M., Allison, A., & Nye, C. L. (1999). Gay, Lesbian, and Bisexual Youths: Separation-Individuation, Parental Attitudes, Identity Consolidation, and Well-Being. *Journal of Youth and Adolescence*, 28(6), 719–739. <https://doi.org/10.1023/a:1021691601737>
- Fox, R. C. (1995). Bisexual Identities. *Lesbian, Gay, and Bisexual Identities over the LifespanPsychological Perspectives*, 48–86. <https://doi.org/10.1093/acprof:oso/9780195082319.003.0003>
- Gonsiorek, J. C. (1995). Gay Male Identities: Concepts and Issues. *Lesbian, Gay, and Bisexual Identities over the LifespanPsychological Perspectives*, 24–47. <https://doi.org/10.1093/acprof:oso/9780195082319.003.0002>
- Jenkins, M., Lambert, E. G., & Baker, D. N. (2007). The Attitudes of Black and White College Students Toward Gays and Lesbians. *Journal of Black Studies*, 39(4), 589–613. <https://doi.org/10.1177/0021934707299638>
- Jourian, T. (2015). Evolving Nature of Sexual Orientation and Gender Identity. *New Directions for Student Services*, 2015(152), 11–23. <https://doi.org/10.1002/ss.20142>
- Katz-Wise, S. L., Rosario, M., & Tsappis, M. (2016). Lesbian, Gay, Bisexual, and Transgender Youth and Family Acceptance. *Pediatric Clinics of North America*, 63(6), 1011–1025. <https://doi.org/10.1016/j.pcl.2016.07.005>
- Kibrik, E. L., Cohen, N., Stolowicz-Melman, D., Levy, A., Boruchovitz-Zamir, R., & Diamond, G. M. (2018). Measuring Adult Children's Perceptions of Their Parents' Acceptance and Rejection of Their Sexual Orientation: Initial Development of the Parental Acceptance and Rejection of Sexual Orientation Scale (PARSOS). *Journal of Homosexuality*, 66(11), 1513–1534. <https://doi.org/10.1080/00918369.2018.1503460>
- Klein, F. (2014). *The Bisexual Option: Second Edition*. Taylor and Francis.
- Klein, F. (1990). The need to view sexual orientation as a multivariable dynamic process: A theoretical perspective. In D. P. McWhirter
- S. A. Sanders, & J. M. Reinish (Eds.), *Homosexuality/heterosexuality: Concepts of sexual orientation*. The Kinsey Institute series (Vol. 2, pp. 277-282). New York: Oxford University Press.
- Lev, A. I. (2004). *Transgender emergence: Therapeutic guidelines for working with gender-variant people and their families*. New York: Routledge
- Lewis, D. C., Flores, A. R., Haider-Markel, D. P., et al. (2017). Degrees of Acceptance: Variation in Public Attitudes toward Segments of the LGBT Community. *Political Research Quarterly*, Vol. 70(4). Retrieved from <https://journals.sagepub.com/doi/abs/10.1177/1065912917717352>.
- Love, P. G. "Cultural Barriers Facing Lesbian, Gay, and Bisexual Students at a Catholic College." *Journal of Higher Education*, 1998, 69, 298 – 323.
- McCormick, A., Schmidt, K., & Terrazas, S. R. (2016). Foster family acceptance: Understanding the role of foster family acceptance in the lives of LGBTQ youth. *Children and Youth Services Review*, 61, 69–74. DOI:10.1016/j.childyouth.2015.12.005
- Miller, S. (2015). A Queer Literacy Framework Promoting (A)Gender and (A)Sexuality
- Self-Determination and Justice. *The English Journal*, 104(5), 37-44. Retrieved July 10, 2020, from www.jstor.org/stable/24484578
- Moleiro, C., & Pinto, N. (2015). Sexual orientation and gender identity: review of concepts, controversies and their relation to psychopathology classification systems. *Frontiers in Psychology*, 6. DOI: 10.3389/fpsyg.2015.01511 <https://onlinelibrary.wiley.com/doi/full/10.1111/j.1744-6171.2010.00246.x>
- Payuyo, L. (2012). The Portrayal of Gays in Popular Filipino Films, 2000 to 2010 [Abstract]. *Philippine Sociological Review*, 60(Special), 291-322. Retrieved September 3, 2020, from https://www.jstor.org/stable/43486348?seq=1#page_scan_tab_contents.
- Raffo, S. "Introduction." In S. Raffo (ed.), *Queerly Classed*. Boston: South End Press, 1997.
- Rindfuss, R., Liao, T., & Tsuya, N. (1992). Contact with Parents in Japan: Effects on Opinions toward Gender and Intergenerational Roles. *Journal of Marriage and Family*, 54(4), 812-822. DOI:10.2307/353163
- Rosenkrantz, D. E. (2018). Factors Impacting Parental Acceptance of an LGBT Child (Doctoral dissertation). Retrieved from https://uknowledge.uky.edu/edp_etds/69/.
- Ryan, C., Russel S. T., Huebner, D., et al. (2010). Family Acceptance in Adolescence and The Health of LGBT Young Adults. *Journal of Child and Adolescent Psychiatric Nursing*, Vol. 23(4), pp. 205-213. Retrieved from
- Vanderbosh, J. "Notes from the Working Class." In S. Raffo (ed.), *Queerly Classed*. Boston: South End Press, 1997.
- Van Leent, L., & Mills, K. (2017). A Queer Critical Media Literacies Framework in a Digital Age. *Journal of Adolescent & Adult Literacy* 61(4), 401-411. DOI: 10.1002/jaal.711



Tactics & Tenacity: The Effects of a Fantasy-Based Tabletop Role-Playing Game on the Decision-Making Skills of Young Adults

Alberta P. Lirio, Jacquelyn D. Cabatay, Chelsea Dominique O. Pongan,
 and Ashley Yvone S. Tsang
De La Salle University Integrated School, Manila

Niña Ana Marie Jocelyn A. Sales
De La Salle University Manila

Abstract: Decision-making is an essential factor for role-playing games (RPGs), especially in tabletop role-playing games (T.T.R.P.G.) like Dungeons & Dragons (D&D). The utilization of RPGs in the past was for studies performed on the rational decision-making processes involving land reformation. D&D aided in examining the player’s experiences when exploring oneself. Backed by previous studies, the research focused on the Rational Choice Theory (R.T.C.) and the Rational Choice Model (R.C.M.) to examine and calculate the benefits derived from the decisions made by the experienced and inexperienced players within a D&D campaign. The research team used R.C.M. to assess whether or not the decision-making process aided both types of players to reach their goals in the game. A one-shot D&D campaign was held across eight (8) different groups composed of five to seven mixed types of players within two days to gather the necessary data necessary for the assessment. Though a slight gap was discovered in-between the rational decision-making process of experienced and inexperienced players, the findings still verified that the former tended to make more informed and rational decisions while prioritizing efficiency in finishing the campaign within the given time frame rather than the inexperienced players. As observed, the latter possessed similar goals for most of the campaign period but were inclined to act more based on impulse.

Key Words: Decision-Making Skills; Rational Choice Theory (R.C.T.); Dungeons and Dragons (D&D); Psychology; Table-Top Role-Playing Games (T.T.R.P.G.)

1. INTRODUCTION

Dungeons and Dragons (D&D) is a tabletop fantasy role-playing game created by Gary Gygax and Dave Arneson (1978) [3]. The game relies on the imagination of its participants, comprised of three (3) or more players, including the Dungeon Master (DM), who control the Player Characters (P.C.s) with individual roles portrayed in the game. (Gygax, 1978) [3].

The study focused on how the human mind functioned, especially on how humans behaved and thought. By analyzing and understanding human behavior, studies involving psychology found improvement in these behaviors and solved people’s issues. (McCormick, 2019) [5] The group infers that one could use Psychology to explore Dungeons and Dragons and how players think, behave, act, and improve personally through playing the game.

1.1 Conceptual Framework

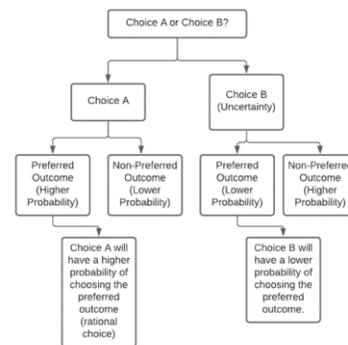

Implemented in the study is Adam Smith’s Rational Choice Theory (R.C.T.). In this framework, individuals produced different outcomes depending on the preferences presented to them. Among these outcomes were a preferred outcome or a goal. According to R.C.T., individuals assigned each choice’s probability to their desired outcome and a number



that describes how much they preferred achieving that choice and outcome. It is then classified as a rational choice if the individual chooses the option that they believe to be the most likely to achieve that outcome (according to the examples and diagrams made by Joseph Kaplan, (2005) [4].

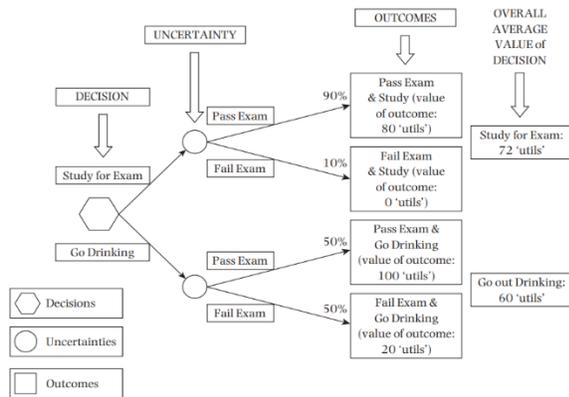

Another point to consider is Herbert Simon's theory of "Bounded Rationality (1956)," [10] which emphasizes the individual's ability to make sound decisions bounded by the information available for them and their capacity to process information and make decisions.

1.2. Scope and Limitations

The study focused on rationality in the context of the R.C.T. as a framework. It included the concept of Bounded Rationality as a factor that could affect rational decision-making. The study's participants were collegiate IEDESGN students from De La Salle University (DLSU) Taft and Laguna Campus whose ages ranged from 18 to 25. The Dungeons and Dragons' edition that the Dungeon Masters would utilize during the campaign would be the Dungeons and Dragons 5th Edition.

1.3. Review of Related Literature

Manuela Pak and Daniel Brieva wrote a paper on utilizing role-playing games (RPGs) to improve decision-making in landscape transformation to analyze rational decision-making (2010) [8]. The study focused more on the factors that go into decision-making, using RPGs in its methodology, interviews, with historical research on landscape dynamics. They observed the behavior, priorities, and reasoning the players possessed when it came to land transformation. The study discovered that RPGs could be an excellent tool for monitoring and understanding decision-making for land reformation.

Joel G. McCormick (2011) [5] discussed the

evaluation of crime prevention strategies in Urban Parks using R.C.T. The basic premise is that humans will choose the offers with the most benefit for the least cost, assuming that the considered benefits and the losses of a decision were made clear before taking action (McCormick, 2011) [5].

Marinela Y. Paulino and Sherwin U. Cuason's study regarding "Role to Play: Examining the Player Experiences of Dungeons & Dragons" (2017) [2] concluded that players who genuinely immerse themselves in the game could explore themselves. As mentioned in Nephew's book of *Playing with power: the authorial consequences of role-playing games* (2003) [7], the players and the GM were "active readers and interpreters of the text." Players could freely control the story they created, which played a crucial factor in deciding what to do, where to go, and how to act.

2. METHODOLOGY

Research Design

"N.E.R.D.D Encounter" was a two-day long online event hosted by the Greasy Snitches Community via their Community Server on Discord. An instant messaging and digital distribution platform. Created inside the server were multiple voice and connected text channels that represented the different tables, and implemented were several bots to compensate for the rolling of the dice function made by the participants. Dedicated to the assignment of players to the different tables was the focus for the first day. The different DMs spearheaded the commencement of the character creation process.

The second day focused mainly on the one-shot campaign that ended on sundown with a survey to assess the entire event. The research team joined the different tables (entered the different channels) to observe the in-game decision-making process among the group's different members. Data were analyzed qualitatively, as the survey's questions are not fixed and answered in a paragraph format.

Scenario 1 featured a clear path and a path with jagged rocks. The N.P.C. instructed the players to pass through the course of the jagged rocks. However, a straightforward way would look relatively safer. Scenario 2 presented one to three options on convincing the Wolf Tribe to ally with the Mother Tusk. The characters persuaded them, prove themselves or hunt for the food of the wolf tribe. The scenario focused more on the reasoning and playstyle of the players.

2.1. Sampling

The study's participants were the different IEDESGN Introduction to Game Design Collegiate



Students, handled by Ms. Sales that belonged to the Taft and Laguna Campus of De La Salle University (DLSU). Introducing D&D to the students was an essential factor to the Game Design course syllabi, and having a mini-campaign was highly beneficial for the topic learning outcomes to materialize. The students possessed varying amounts of experience with D&D ranging from experienced players and DMs and individuals who have never heard of D&D at all. The research team classified players who have played for more than six (6) months as ‘experienced.’ The Greasy Snitches,’ a local group of experienced T.T.R.P.G. players, assisted in the research acting as the organizers of the game.

2.2. Data Gathering/Procedures

The procedures followed were set by Pak and Brieua (2010) [8] in their paper that used RPGs to observe decision-making in land transformation. All monitored sessions noted the behavior, decisions, and discussions of all the participants. They gave the research team an idea of what to consider when they made decisions and what the players prioritized during decision-making. The research team also interviewed the D.M.s after the event to gain insight and validate the gathered observations. A survey was sent to the participants afterward to understand the reasoning behind their decisions.

2.3. Data Analysis Strategy

One of the model papers that utilized R.C.T. as a framework employed the “Qualitative Strategy.” This strategy, found in Neuman’s Social Research Methods: Qualitative and Quantitative Approaches in 2014 [6], encouraged the research team to organize the data by repeated patterns and themes found within this data. Afterward, the data was cross-checked with the D.M.s’ comments before the research team finally analyzed the framework and the factors that go into decision-making.

2.4. Instrumentation

The questionnaires present in Sarah Lynne Bowman’s book, *The Functions of Role-Playing Games: How Participants Create Community, Solve Problems and Explore Identity* (2010) [1], were modified to fit the research’s scope precisely. The distribution of questionnaires was through Google Forms after the event for convenience. The research team used Discord to hold the campaigns and provide a space for the research team to make live, online observations.

3. RESULTS AND DISCUSSION

3.1. Data Analysis

While observing the participants, the group first took note of the choices made and took note of the discussion leading up to the participants’ decision and any points. It was cross-checked as well with the participant’s responses in the survey questionnaire. With all the information gathered from the questionnaire and notes from the live observations, the research team gleaned the following analysis:

3.1A. Preferred Outcome

The majority of the players, both experienced and inexperienced, were focused more on accomplishing the one-shot campaign’s tasks. It is worth noting that a small percentage of the inexperienced players focused more on the game’s entertainment aspect than the objective. Around 19% of the amateur players stated that their decisions were based more on entertainment value.

The data shows that D&D players may have different priorities and goals within the game than just accomplishing the quest given to them by the D.M. However, one must note that a player prioritizing entertainment over objective is not irrational. Under the framework, if they make decisions that lead them to the outcome they prefer, it would still be considered rational. If entertainment is the outcome they desired, then they would be regarded as sound.

3.1B. Decisions Made and Probability of the Preferred Outcome



Figure 2.7.1 Scenario 1 Choices

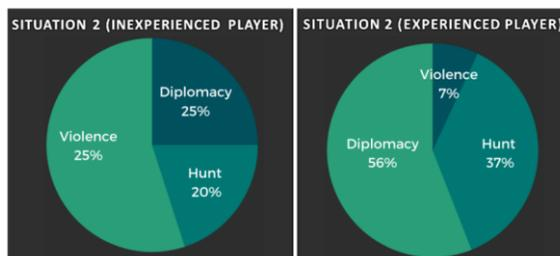

Figure 2.7.2 Scenario 2 Choices



In Scenario 1, a more significant percentage of inexperienced players preferred to go through the clear pathway (57%) rather than the jagged rock's path (43%). However, with the experienced players, a more considerable percentage (54%) preferred to cross the jagged rock's path over the clear pathway path (46%). In the context of Scenario 1, players may prefer the clear pathway as it seems safe. However, they were aware that the other path is the efficient path to take as it was the road that the N.P.C. mentioned and, therefore, the one most likely to bring them to their destination. It is here that the research team were able to see that the experienced players were more likely to make choices that would bring them to their preferred outcome.

Upon interviewing the participants, the research team found that the majority of the participants, both experienced and inexperienced, were somewhat expecting the outcomes of their choices, meaning that most of them were slightly aware of the probability of the results they got.

In Scenario 2, 55% of the participants opted for diplomacy, 20% decided to hunt for the wolf tribe, and 25% had to attack them and prove themselves. As for the experienced players, 56% of the participants opted for diplomacy, 37% opted to hunt for the wolf tribe, and 7% fought the wolves to prove themselves. As for this fight, most experienced and inexperienced players were not expecting the outcomes they got, demonstrating how they believed to have a lower probability of achieving their preferred outcome. According to the surveys, most of them were expecting to fight the wolves; however, they could complete the effect they wanted through a means that they preferred more (safety through diplomacy.) In this case, most of the players achieved their desired outcome and preferred choices; however, they did not see a high probability of the outcome they chose behind their choices.

3.1C. Outcomes Based on the Decisions Made

Based on observations gathered from both the live observations and analyzed notes, a noticeable difference between the two types of participants regarding their decision-making is observed. A large portion of skilled players had exceptional foresight when it came to their choices. On the other hand, some inexperienced players did not have a clear plan in mind as they were not making any decisions beyond what was needed. That uncertainty caused them to make more impulsive decisions without thinking it through enough, as mentioned by some of the participants upon interviewing and from observations made by both the research team and the D.M.s. About 38% of the inexperienced participants acted

impulsively, while 14% of the experienced players did the same.

3.1D. Reasoning

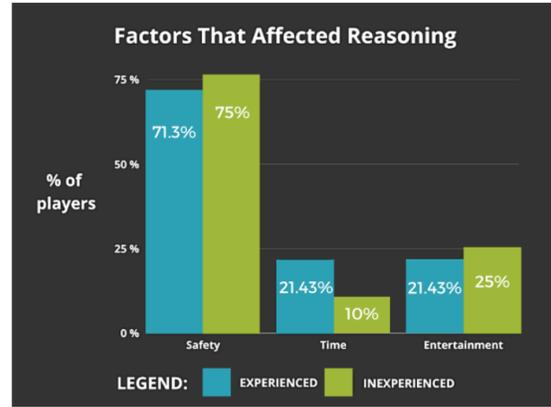

Figure 3. Factors That Affected Reasoning

Most of the participants chose to base their reasoning on their party's safety and preservation. It applied to 71.3% of experienced players and 75% of inexperienced players. 21.43% of the veteran players based their reasoning of the time it would take to do actions based on their decisions, and the same is observed for 10% of inexperienced players. Therefore, more experienced players were more time conscious than amateur players. 21.43% of professional players' reasonings were motivated by entertainment, and this also applied to 25% of inexperienced players. There was not a significant rift between these two results.

3.1E. Utilization of Information

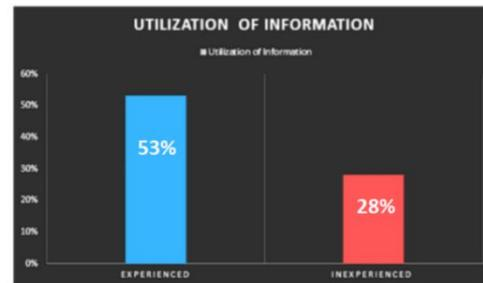

Figure 2.11.1 Utilization of Information between Experienced and Inexperienced Players

The data gathered showed that experienced players were more resourceful with the information they had. About 53% of the skilled players relied more on the information they had when arriving at their chosen decision. On the other hand, 28% of the inexperienced players focused more on utilizing the information they had in their decision-making.

Upon observation from both the D.M.s and the research team, some tables struggled with making decisions due to a lack of information (such as perception and survival that could help them



understand their surroundings more.) The tables with more information (good roles or characters that can provide better information on the environment) eased their decisions. From this, the research team were able to see that playing the game helped certain players understand and utilize given information better and make better decisions.

4. CONCLUSIONS

The study mainly focused on the decision-making patterns of both experienced and inexperienced D&D players. In conclusion, the more experienced players tend to make more informed, timely, and rational decisions that aided in achieving their preferred outcome. Most of these players prioritized efficiency in finishing the campaign by focusing on the objective. On the other hand, though the inexperienced players possessed the same goals (even with a small percentage of them prioritizing entertainment) as the experienced ones, they still did not utilize what information they had and tended to act more on their impulse preferred choices. While the statistical differences were not extreme in number, there was still undoubtedly a gap between the experienced players' rational decision-making and the inexperienced players.

4.1 Recommendations for Future Study

It is highly recommended that further research be conducted on how T.T.R.P.G.s can affect decision-making and prove that such games are beneficial to improve a person's decision-making skills. Given the study's findings, it is deemed that games like D&D can provide a platform for players to practice their rational decision-making and perhaps even perform better in education and development. Other kinds of role-playing games, such as Pathfinder, Call of Cthulhu, and even those belonging to the non-table top realm, such as video games, could also be utilized for this endeavor. Other theories that apply to rational decision-making may be utilized to aid future studies in understanding the behavior of experienced and inexperienced players when it comes to making sound decisions. Exploring other entities outside of an institution and the current age group would also provide a broader perspective on the study. It is also recommended to try other T.T.R.P.G.s, with more experienced players and explore the more social aspect of D&D towards its effect on decision-making, such as peer pressure.

In the course of the study, some players were deemed more inclined to make certain decisions based on their group's influence or another player's charisma. In the future, further studies in terms of group dynamics' influence on an individual's decision-making are necessary. Future researchers can further investigate the group's decision-making process in

T.T.R.P.G.s and how charisma can influence people into making certain decisions.

5. ACKNOWLEDGMENTS

Special thanks to Mr. Christian Gopez, the S.H.S. Research Coordinator for H.U.M.S.S., ADT, and SpT, for being patient throughout the entire Senior High School journey, to Mr. Paul Gabat and all the Volunteer Dungeon Masters (DMs) and faithful Members of the Greasy Snitches (D&D) Community who organized the campaign and faithfully supported the entire planning process of the event utilized by the study and to all the De La Salle University (DLSU) Taft and Laguna Campus IEDESGN (Introduction to Game Design) students who participated in the study and allowed the utilization of the collected data for the study.

6. REFERENCES

- Bowman, S. L. (2010). *The functions of role-playing games: How participants create community, solve problems and explore identity*. Jefferson: McFarland & Company.
- Cuason, S.U., & Paulino, M.Y. (2017). Role to play: examining the player experiences of Dungeons & Dragons. *The Bedan Journal of Psychology*. Retrieved September 29, 2020, from
- Gygax, G. (1978). *Player's Handbook*.
- Kaplan, J. M. (2005). Rational Decision Making: descriptive, prescriptive or expletory? In 953303749 742922024 A. Nelson (Ed.), *a companion to rationalism* (pp. 425-447). Hoboken, New Jersey: Blackwell Publishing.
- McCormick, J. G. (2011). *National Evaluation of Crime Prevention Strategies in Urban Parks: Using Rational Choice Theory to Understand Decisions of Park Directors and Professors* (thesis). University of Florida, Gainesville.
- Neuman, L. (2014). *Social Research Methods: Qualitative and Quantitative Approaches*. Pearson New International Edition, 7.
- Nephew, M.A.B. (2003). *Playing with power: the authorial consequences of role-playing games*. The University of Wisconsin-Milwaukee.
- Pak, M. V., & Brieva, D. C. (2010). Manuela Vieira Pak, Daniel Castillo Brieva, *Designing and implementing a Role-Playing Game: A tool to explain factors, decision making and landscape transformation*. *Environmental Modelling & Software*, 25(11), 1322–1333.
<https://doi.org/https://www.sciencedirect.com/science/article/pii/S1364815210000745>
- Richard, W. L., & McGee, J. R. (2013). *Rational Choice Theory*. in *theory in social and cultural Anthropology: an encyclopedia account* (pp. 688-689). California: SAGE Publications.
- Simon, H. A. (1990). *Bounded Rationality*. In *Utility and Probability* (pp. 15–18). essay, Palgrave Macmillan



Drowning Screens: Social Media Experience and the Emotional Well-Being of Filipino Adolescents

Bea Claire W. Antiporda, Adrienne B. Juanengo, Alleiah Jan L. Malaluan
and Rona Mae Paula H. Martin
De La Salle University Integrated School, Manila

Dr. Crisanto Regadio, Jr.
Behavioral Sciences Department College of Liberal Arts

Abstract: This study explored the social media experience in Facebook and Twitter and its relation to the emotional well-being conditions of twenty (20) senior high school students in Metro Manila. Online in-depth interviews were conducted that centered on the quality of their Facebook and Twitter experience, the prevalence of distress, negative emotions, and life satisfaction. Facebook and Twitter have been utilized for entertainment and maintenance of social networks online. However, Facebook has been maintained as a “les lieux de communication” or a space to communicate with friends, family members, and classmates. Yet, due to its “public” nature, the participants were inhibited from sharing their thoughts and feelings in their Facebook account. On the other hand, multiple Twitter accounts have been maintained: for public consumption and an “exclusive” account. This exclusive Twitter account has been maintained as a “les lieux de emotion” or a social space wherein they could be inhibited on what ideas, opinions, or sentiments they will share. Experiencing distress, negative emotions, and satisfaction with everyday life has been associated with utilization of Facebook and Twitter due to issues on accessibility and unwarranted information, lack of control on popping up pornographic materials, and the threat of hacking and breached in their “les lieux de communication” and “les lieux de emotion.” Moderation and vigilance should be maintained in utilizing social media accounts to mitigate the risks of negative experience and impact on one’s emotional well-being.

Key Words: social media experience; emotional well-being; Facebook; Twitter; Filipino adolescent

1. INTRODUCTION

Social media has become an integral part of an individual's life for this allows people to connect, create, and collaborate, wherein it has also been used to convey one's feelings, thoughts, and ideas. Despite this, there has been developing literature that provides evidence on the changing motives, attitudes, and behaviors due to one's involvement in social media. A study by Rasmussen, Carter, LaFreniere, Norman, and Kimball (2020) elaborated on how one's emotions are affected due to the excessive use of social media, resulting in complications on emotion regulation. Some individuals have positive experiences such as encouraging posts, entertainment, and accessibility, while others have negative experiences like having fake news, malicious posts, and inappropriate content from other social media users. Young, Kolubinski, and Frings (2020) stated that the role of social media on one's emotional well-being could help boost self-worth, increase self-esteem, provide joy, and prevent loneliness. On the

other hand, negative engagement in social media, such as promoting toxicity, bashing people online, and more, creates effects that may damage an individual's well-being in the long run.

As Filipino adolescents engage in social media, they encounter experiences that are positive or negative. Datu, Yang, Valdez, and Chu (2018) stated how self-expression correlates with online engagement, elaborating that positive experiences are when individuals share their sentiments and like towards each other, while negative experiences are when individual are exposed and have become involved in inappropriate behavior resulting to the user's emotional, psychological, and emotional well-being affected. With this, the issue of one's engagement in social media centers on its unique characteristic, to provide an avenue for an individual to communicate their feelings, ideas, and sentiments.



Review of Related Literature

1.1. Social Media Experience

Adolescents are usually immersed in social media since they frequently use it in their daily lives. The effects of online life given a highlight on social connectedness explain that social networking experiences may build up its setting, which could be versatile to an individual. A better understanding of the contributing factors is necessary, given the severity of these conditions, their negative and potentially long-term consequences for adolescents. Based on the research by Kelly, Zilanawala, Booker, & Sacker (2018), utilizing social support and knowledge acquisition can be beneficial when using social media since it could help improve and understand the underlying processes. Also, it could help identify opportunities for interventions that could benefit adolescents in social media.

1.2 Emotional Well-being

Numerous literature defines emotional well-being as having the absence of any mental health problem. Brown's article tackles emotional well-being and its relation to health, citing WHO's definition of emotional well-being, "a state of complete physical, mental and social well being" (p. 1). It was emphasized that the importance of emotional well-being to a person's health shows that being emotionally healthy means that one knows how to deal with the highs and lows of life while having confidence and a positive outlook in life. However, when one doesn't pay attention to their emotional well-being, they could develop emotional distress and encounter various illnesses, such as being prone to different viral illnesses, developing stress, and the like.

1.3. Social Media Experience and Emotional Well-being

The role of social media in adolescent's lives has become central and globally ubiquitous. At the same time, many advantages of using social media are existent, like having more prominent connectedness with others. According to Brunborg & Andreas (2019), social media, being a significant part of adolescents' lives, may relate to negativity as an effect. Connections between the time spent engaging in social media and emotional well-being issues, such as depression and anxiety, were found since their social media engagement could be the potential intervening pathways relating to their emotional well-being.

1.4. Statement of the Problem

This study explores the social media experiences and their relation to the emotional well-

being among Senior High School students in De La Salle University-Manila. The following specific questions were sought:

1. What is the social media attitude and behavior of the participants?
2. What is the type and quality of social media experiences of the participants?
3. What is the type and quality of emotional well-being of the participants?
4. How do online attitudes and behaviors and type and quality of social media experiences relate to the type and quality of emotional well-being?
5. What is the overall emotional well-being of the participants?
6. How do social media, the extent of social network, social media experience, and attitude and behavior towards social media relate to the emotional well-being of the participants?

2. METHODOLOGY

This qualitative research utilized a purposive sampling method in selecting the participants. Fifty (50) senior high school students were initially invited and screened based on the following criteria: 1) have Twitter and Facebook accounts; 2) spends at least 4 hours of active engagement in Twitter and Facebook; 3) often or regularly likes or reacts to posts; 4) often or regularly comments on others' posts, and 5) often or regularly posts on their social media accounts. A final list of twenty (20) participants was engaged in an in-depth online interview which centered on their utilization of Facebook and Twitter, the quality of the social media experience in Facebook and Twitter, issues and concern with Facebook and Twitter, and their experiences of distress and negative emotions as well as their self-assessment of life satisfaction. The six-stage thematic analysis by Braun and Clarke (2016) guided the coding and identification of the major themes. Ethical guidelines set by the DLSU Integrated School have been observed, including, but not limited to, securing informed consent and voluntary participation.



3. RESULTS AND DISCUSSION

3.1. Facebook and Twitter as an Integral Part of Everyday Life

Facebook and Twitter are two of the most used social media applications, especially for adolescents. Both platforms may bring beneficial and disadvantageous uses for their users. As the world increasingly depends on technology, the utilization of these platforms has also been developing. Both platforms provide entertainment, access to information, and maintenance of social ties online. However, the participants of the study highlight the distinction on the primary utility of Facebook and Twitter as social media. The distinction is associated with the type of activities, posts, or information they access when logged in.

Facebook and Twitter are avenues for individuals to share their insights and experiences in life. With Facebook being a social media platform for meeting and interacting with people, it provides an opportunity for individuals to become more open and expressive online. Exclusivity in the application ultimately covers whether the users would accept friend requests, including determining whether the type of content they possess online is fit for their liking. On the other hand, Twitter is a social media platform wherein individuals freely express their opinions and share their experiences online; similar to Facebook, it is extensive in a way that it is universally used as an “online diary” for individuals. Twitter can also be exclusive in a way that users have the ability to private their account, wherein they can choose the people who can view their account since follow requests are enabled.

3.2. Facebook as a ‘Les Lieux de Communication

Facebook is maintained as a place of communication, especially since most participants use Facebook for educational purposes wherein they check their Facebook groups and group chats to be updated about their academics. Additionally, they use this to connect with their friends, family, and relatives to keep in touch and maintain their relationship with one another. This also includes chatting with their classmates when necessary.

Facebook is known to be a universally used social media platform; it serves as the main way of communication for most people on the internet. Consequently, the majority of the users stated that there were issues regarding their privacy online. In addition, the participants of the study value privacy and exclusivity; in return, the decision in accepting friend requests was based on the relationship with the

person online. Simultaneously, blocking Facebook friends was also evident because it would stem from how they think the participants are online. Thus, most Facebook users find this need since the prevalence of suspicious activity online bothers them. The participants usually block people who oppose their political stands, when they find the other person weird and annoying, and whenever a stranger starts to show suspicious activity.

3.3. Twitter as a “Les Lieux de Emotion”

Twitter users maximize the platform to post and express their emotions and feelings through tweets. Provided that Twitter is a more private platform than Facebook, it is maintained as a place of emotion as participants are inclined to express themselves through tweets since users can post their emotions more freely without the fear of privacy invasion, particularly by their relatives. Especially in this day and age, wherein adolescents use social media as a platform to rant about their daily lives, most of the participants have said to do this activity more on Twitter.

When the participants were asked about how they use their Twitter account/s, the majority of the Twitter users make use of more than two accounts: one is two fully share their opinions and sentiments to which is only open to their closest friends, another may be a stan account in order to support the people they idolize, and another is a more formal and professional Twitter account wherein their tweets, retweets and likes are open to the public. Thus, people use Twitter as a personal application to share their sentiments and opinions.

Most of the participants considered the need to block people due to suspicious acts and inappropriate tweets. The participants would often block people who spread negativity, such as fake accounts and threats. Moreover, fewer Twitter users use the block option in the application since they have not encountered any experience to deem this feature applicable. Thus, Twitter users use the block feature to avoid negativity and suspiciousness to prevail on their timelines.

3.4. The Emotional Well-being of Facebook and Twitter Users

Considering how social media platforms like Facebook and Twitter could significantly impact its users’ quality of experience, participants classify these experiences as either positive or negative. Positive experiences are associated with positive thoughts and feelings like being happy in being able to communicate with friends and classmates, relieved to be updated with what is happening in school, with the situation



of people they love, and being able to get the information that they need whenever they want them. The participants associated the distress and negative emotions that they feel with their utilization of Facebook and Twitter. There are instances where unwarranted information is made public online or accidentally views pornographic and disturbing materials. Additionally, most participants are inhibited from expressing themselves freely in their public accounts because of fear of being targeted by “cancel culture.” Moreover, the feeling of distress and anxiety are associated concerns on their account’s privacy. These include fear of hacking, receiving random messages, and group invitations. Consequently, the uncanny social media algorithm disconcerts them, making the users feel unsafe. One of the biggest worries is the idea that their “private” thoughts and emotions are shared with other people outside their “exclusive” online circle. Unwarranted information overload is also causing the participants distress and makes them anxious like trigger warnings, especially COVID-19 concerns. Also, viewing the achievements of their networks posted online makes them feel insecure about themselves, which significantly affects their life satisfaction because they think they have a lot of things missing in their lives.

4. CONCLUSIONS

Facebook and Twitter are social media platforms that have become an integral part of the life of Filipino youth, evident in the narratives of the participants of this study. They are both utilized as a tool for communication, entertainment, access to information, and maintenance of their social ties online. However, Facebook has been maintained as a “les lieux de communication” or a space to communicate with friends, family, and classmates. Although, due to its “public” nature, the participants were inhibited from sharing their thoughts and feelings in their Facebook account. On the other hand, multiple Twitter accounts have been maintained: for public consumption and an “exclusive” account. This exclusive Twitter account has been maintained as a “les lieux de emotion” or a social space wherein they could be inhibited on what ideas, opinions, or sentiments they will share. One of the interesting findings of this study is the association of Facebook and Twitter as an online space of toxicity and negativity. Thus, experiencing distress, negative emotions, and satisfaction has been associated with utilization of Facebook and Twitter due to issues on accessibility, unwarranted information, lack of control on sudden posts of pornographic materials, and the threat of hacking and breaching in their “les lieux de communication” and “les lieux de emotion.” Moderation and vigilance should then be maintained

in the utilization of social media accounts to mitigate the risks of negative experiences and impact on one’s emotional well-being.

5. ACKNOWLEDGMENTS

The research would not be accomplished and made possible without the help of valuable people. We would like to express our gratitude to our mentor, Dr. Crisanto Regadio Jr., and our research professors, Ms. Madeleine Sta. Maria, Ms. Omega Diadem Danganan, and Mr. Christian Gopez for the opportunity given to showcase our capability and assets. You have been our guidance and role models, which made us possible to finish the research promptly and efficiently. You have been supportive and responsive in times we need assistance.

In addition, we would like to extend our appreciation to the publishers and authors of our used research resources; without these, we would not be inspired to pursue the research proposal. The used sources have been our lead to understand each other’s main points.

To our family, especially our parents, thank you for the never-ending love and care you continue to give us. You have been our driving force to do our best in order to achieve success. You have been our walls and roots whenever we feel downhearted; you are always present to remind us that stopping and giving up would not do anything good. Thank you for understanding our busy schedules and for adjusting whenever we have immediate plans to attend to.

To those who were eager to participate in our research. To the senior high school students of the De La Salle University Senior High School - Manila Campus, for helping us in our data collection and being patient with us in our research process. Without your help, this research wouldn’t be possible, and we wouldn’t be able to gather the data we needed.

Last but not least, the researchers would like to offer thanks to our God; through His grace and blessings, we would not be able to finish the research paper without giving up. We have been able to accomplish given tasks by living up in His faith that in His way, we would not falter and grow weary.

6. REFERENCES

- Braun, V. and Clarke, V. (2006) Using thematic analysis in psychology. *Qualitative Research in Psychology*, 3 (2), 77-101. <http://dx.doi.org/10.1191/1478088706qp063oa>
- Brunborg, G., & Andreas, J. (2019). Increase in time spent on social media is associated with modest increase in depression, conduct problems, and episodic heavy drinking. *Journal of*



3RD DLSU SENIOR HIGH SCHOOL RESEARCH CONGRESS

LIVING CULTURE AND
CONTEMPORARY SOCIETIES

Adolescence, 74, 201-209. <https://0-www-sciencedirect-com.lib1000.dlsu.edu.ph/science/article/pii/S0140197119301046>

Datu, J., Yang, W., Valdez, J., & Chu, S. (2018). Is facebook involvement associated with academic engagement among Filipino university students? A cross-sectional study. *Computers and Education*, 125, 246-253. <https://0-www-sciencedirect-com.lib1000.dlsu.edu.ph/science/article/pii/S0360131518301532>

Kelly, Y., Zilanawala, A., Booker, C., & Sacker, A. (2018). Social Media Use and Adolescent

Mental Health: Findings From the UK Millennium Cohort Study. *EClinicalMedicine*, 6, 59-68. <https://doi: 10.1016/j.eclinm.2018.12.005>

Rasmussen, E., Carter, N., LaFreniere, J., Norman, M., & Kimball, T. (2020). The serially mediated relationship between emerging adults' social media use and mental well-being.

Computers in Human Behavior, 102, 206-213. <https://0-www-sciencedirect-com.lib1000.dlsu.edu.ph/science/article/pii/S0747563219303061>



Ethnocultural Analysis on Different Practices of the Bihog Tribe (Agta) on Childbearing

Khriselle Estrope and Nathan Abram Faith Moreno
Tagkawayan National High School, Tagkawayan, Quezon

Samboy D. Niala
Tagkawayan National High School, Tagkawayan, Quezon

Abstract: Bihog Tribe (Agta) has different beliefs and cultural practices in childbearing. They have their traditional medicines, ceremonies, coping mechanisms, and food eaten during the pregnancy period, labor, and postpartum. The study used an ethnographic type of research in qualitative approach. Interview protocol was utilized to gather information about their culture and beliefs. The subjects consisted of three mothers and a midwife, with a total of four that were purposively selected. The study was conducted in Sitio Mapatong, Brgy. Sto. Tomas, Tagkawayan, Quezon. The answers from the interviews and discussions proved that their culture and traditions were effective enough to allow childbearing to happen without medical interventions. Moreover, they used medicinal herbs such as 'lagundi', ginger, and 'paminat' (a phytomedicine in the form of rind used to avoid relapsing). 'Pasuob' or smoke ritual was also done to drive 'Danyar' (evil spirits) away. It is also taboo to walk around the tribe for it might attract Danyar and to let pregnant women eat bread because the fetus might grow larger inside the womb that could cause difficulty in labor. On the other hand, the Local Government Unit (LGU) provided help and support to the tribe, including prenatal care, medical supplies, and free check-ups without disturbing the tribe's traditions.

Key Words: Aeta; Bihog tribe; childbearing; prenatal; labor; postpartum

1. INTRODUCTION

1.1. *Background of the Study*

Childbearing is one of the most challenging phenomena in a woman's body, and it is in need of utmost care. The birth of a child can be such a happy time, especially when the little one is in good health. Women give birth to their children with the help of doctors, nurses, and midwives in hospitals and birthing centers nowadays. Local Government Units (LGUs) are now mandated by the government to upgrade birthing facilities.

Before, most women gave birth at their homes because of being distant from hospitals and birthing centers or lack of fortune in finance. This caused the high maternal mortality rate in our country, which is why in 2008, the country passed the Maternal, Newborn and Child Health and Nutrition Strategy policy, dubbed as the "No Home Birthing Policy." Statistics show that 208 mothers of 100,000 live births die due to childbirth and complications. The goal was to reduce the country's high rate of maternal mortality to 52, according to the article of Bacani (2020). On the contrary, ethnic groups from different corners of the Philippines still perform their childbirths at home, not only because of their

remoteness and lack of finance but also because they want to preserve their culture and traditions. One of these tribes is the Agta or Bihog, who resides in Sitio Mapatong, Brgy. Sto. Tomas, Tagkawayan, Quezon.

The Bihog Tribe has small nose, dark brown eyes, and brown skin. They are the Aetas in Province of Quezon. Being an ethnic group, the Bihog Tribe has unusual ways of living, culture, and tradition. Their daily living and practices are culturally diverse from standard society.

Furthermore, Withers and Lim (2018) claimed in their study that cultural beliefs can influence women's use of formal maternal health care services. The traditional beliefs and practices in pregnancy are prevalent in Asia, mostly in tribes that reside in remote areas. Their fear of institutional birth is women's fear of unnecessary medical interventions.

Moreover, Matsubara et al. (2013) stated in their study that women's satisfaction is an important indicator of the quality of care during childbirth. A good environment in the surroundings of a pregnant woman, such as a warm home and good health facility, can increase positive effects in her pregnancy and childbearing. In contrast, an unsatisfying childbearing experience can cause postpartum mental disorder to the mother, which, in a way, agrees with ethnic mothers not wanting the medicine industry to



interfere in their pregnancy and childbirth. Their culture may be more satisfying for them than the modern medical interventions.

Therefore, the researchers would like to determine the beliefs and cultural practices of the Bihog Tribe on childbearing in Sitio Mapatong, Brgy. Sto. Tomas, Tagkawayan, Quezon.

1.2. Statement of the Problem

The study aimed to investigate the different childbearing practices performed by the Bihog Tribe. The study sought to answer the following questions:

1. What are the traditional practices done by the Bihog Tribe in Sitio Mapatong, Brgy. Sto. Tomas, Tagkawayan, Quezon during:

1.1. Prenatal

- 1.1.1. Medicine,
- 1.1.2. Ceremony, and
- 1.1.3. Food eaten?

1.2. Labor

- 1.2.1. Medicine,
- 1.2.2. Ceremony, and
- 1.2.3. Food eaten?

1.3. Postpartum

- 1.3.1. Medicine,
- 1.3.2. Ceremony, and
- 1.3.2. Food eaten?

2. What are the struggles and challenges encountered of an Agta woman during pregnancy and childbirth?
3. What are their coping mechanisms?
4. How does the Agta midwife perform midwifery guardianship?
- 5.

1.3. Significance of the Study

The study is beneficial to the Bihog Tribe (Agta) because it would help them let society and the government know about their experiences regarding childbearing and would motivate the government to provide support and help without disregarding their culture and traditions. Medical practitioners would also be informed about how the tribe performs their procedures on childbearing and will help them distinguish the differences between the modern medical practices and the traditional practices of the tribe. Also, the study might be helpful to the researchers pursuing similar studies that can be beneficial to the Agta.

1.4. Conceptual Framework

Figure 1. Conceptual Framework

The researchers conducted this study by means of following this method represented inside the conceptual framework, which are the input, the process, and the output.

The input of the study focuses on the

objectives or research where the researchers identified the childbearing practices, challenges encountered, and coping mechanisms of Agta women in childbearing.

The process shows how the researchers collect the data regarding the different childbearing practices of the tribe through interviews, reading articles, and data gathering. Also, the researchers participated in the IPs environment.

Lastly, the output of the study is the identified childbearing practices of the Bihog Tribe (Agta). Furthermore, an action plan or community-based research that focuses on the access to the health care system of IPs is recommended.

2. METHODOLOGY

The researchers used an ethnographic type of research by utilizing interviews and discussions to gather data and information about their culture. It was a qualitative approach that focused on investigating and describing the culture and traditions regarding childbearing present in the tribe. The ethnographic design was utilized because the research paper's objective is to determine their culture and traditions through observations and participation in the tribe's environment. The study was conducted in Sitio Mapatong, Brgy. Sto. Tomas, Tagkawayan, Quezon. The location was in an isolated area where the researchers walked for almost three hours. The participants of the study were composed of three Agta mothers and one Agta midwife, a total of four, who could answer the questions from the interview protocol and could provide data regarding the different practices of the Bihog Tribe (Agta) on childbearing. The interview questions were prepared and developed by gathering related literature and were answered by the subjects as the researchers asked the questions. Permission was also sought to do audio recording and video recording, likewise given assurance regarding the confidentiality of the data. The responses were then transcribed and coded for interpretation.

3. RESULTS AND DISCUSSION

3.1 Agta Mothers as the Subjects

Table 1. Herbal Medicines and Decoctions

Subject	Answers	Codes
Mother A	"Halaman sa ubo, Lagundi, oregano."	'Lagundi' and oregano leaves
Mother B	"Naiinom ng luja para mawala yung lamig sa katawan."	Turmeric tea for body cold.
Mother C	"Yung katas ng paminat, iniinom para hindi mabintat hangga't di nauubos kahit araw-araw."	'Paminat' extract is used to avoid relapsing.

Table 1 shows the herbal medicines and decoctions that the pregnant women in their tribe drink. 'Lagundi', turmeric tea, and oregano leaves



were used as remedies for coughs and colds. Tea from 'Paminat', a rind that can be found in the forests and rivers near their tribe, was taken to avoid relapsing from the tiresome pregnancy stage.

Affirmatively, the study of Lamxay et al. (2011) stated that ethnic groups usually use medicinal plants in recovery during pregnancy, postpartum, and infant health care.

Table 2. Beliefs and Traditions Regarding Pregnancy and Childbearing

Subject	Answers	Codes
Mother A	"Bawal maglakad kung saan-saan kapag buntis. Bawal kami sa kalaan baka maamoy ng mga taong di nakikita."	Walking around was forbidden
Mother B	"Bawal kami ng tinapay kasi lalaki yung bata sa tiyan, mahihirapan ilabas."	Bread was restricted
Mother C	"Kapag ang buntis ay nagdadala ng mabibigat, hindi mahihirapan sa panganganak kaya nagkakabod ako noon."	Carrying heavy objects can help in easy and comfortable delivery.

Table 2 shows beliefs and traditions regarding pregnancy and childbearing acknowledged in their tribe. They believe that pregnant women should not walk around the tribe and forests because 'Danyar' (evil spirits) might smell them and bother them. Bread might also result in the growth of the baby before it even comes out of the womb, so it is considered a forbidden food. Lastly, they believe that carrying heavy objects helps in making their labor and delivery a lot easier.

Table 3. Cultural Practices during Childbearing

Subject	Answers	Codes
Mother A	"Pag nahihirapan ilabas [bata], pinapausukan kami. Hinihilot kapag nairi na para mapadali yung paglabas [bata]."	Smoke ritual and caressing of stomach are done for easier delivery.
Mother B	"Sinusuob saka hinihilot para mabilis lumabas yung bata."	Smoke ritual or 'Pasuob' and caressing of stomach are performed.
Mother C	"Pag kami ay nanganganak na, sinusuob kami tapos yung tiyan pinupunasan."	'Pasuob' and caressing of stomach are performed

Table 3 shows their cultural practices during childbearing. A smoke ritual or 'Pasuob' was performed. Caressing of the stomach was also practiced for the baby to come out easily.

They believed that 'Pasuob' is necessary to be performed during pregnancy and labor to prevent 'Danyar' or evil spirits from bothering the mother and child. Almost parallel to the study of Grey (2016), Aetas of Mt. Pinatubo also has a cultural act where they burn rubbers outside the woman's house to drive evil spirits away.

3.2 Agta Midwife as the Subject

Table 4. Ceremonies during Labor and Delivery

Informant	Responses	Corresponding Code
Agta Midwife	"Nagpapasuob. 'Pag naman pwede na maligo na 'yung bagong panganak, kinukuhanan ko lang ng pampaligo. Lukban, saka 'yang anonang, at sambong."	Smoke ritual or 'Pasuob' and caressing of stomach for the fetus to come out of the womb easily Postpartum mother can take a bath when she is allowed to with grapefruit, 'anonang', and 'sambong'.

Table 4 shows the ceremonies during labor and delivery or childbearing that they perform. They have a smoke ritual or 'Pasuob' where they surround the woman's body with smoke. She also caresses the woman's stomach so that the infant can exit through the woman's vagina easily.

The answers of the subject were derived from her knowledge and experiences regarding midwifery guardianship. The subject answered 'Pasuob' and caressing of stomach since these activities were done during their labor and delivery. She also said that grapefruit, 'anonang', and 'sambong' are essentials for postpartum mothers when taking a bath.

4. CONCLUSIONS

The Bihog Tribe has a lot of unusual cultures and traditions regarding childbearing, which is affirmed in the study of Grey (2016). However, the study revealed different cultural practices on driving away evil spirits which might disturb the woman and child. Grey stated that Aeta from Mt. Pinatubo burned rubber outside the house of the pregnant woman while the Agta from Sitio Mapatong, Brgy. Sto Tomas, Tagkawayan, Quezon performed 'Pasuob' using 'tawas', incense, and 'kamanyang', or sometimes 'balete'. Pregnant women are also not allowed to walk around the tribe to avoid 'Danyar' (evil spirits) as part of prenatal care. Thus, the Bihog Tribe used turmeric and Paminat as herbal medicines and implemented food orders, which include restrictions from eating bread and cassava during prenatal, childbearing, and postpartum. The postpartum mother can also wash her body, only when she is allowed to, with grapefruit, 'anonang', and 'sambong'.

The Agta women feared hospitals which made them stick to their usual traditions that might lead to some challenges and struggles such as no proper monitoring, health problems, or worse, death, because of lacking health care assistance. This conclusion affirmed what Withers and Lim (2018) have stated. They stated that one of the barriers to institutional birth is the women's fear of unnecessary medical interventions.

The Agta women coped with the struggles they have encountered by continuing to follow and to



believe the traditions and cultures they have in their tribe. They were also given assistance which affirmed to Matsubara et al. (2013), wherein he stated that satisfaction and a good environment can increase positive effects in the childbearing experience of the mother.

The Agta midwife was taught by her mother, a former tribe midwife, about midwifery guardianship. Her knowledge and professionalism were beneficial to the women of the tribe. She performed midwifery guardianship based on her knowledge about their culture.

5. ACKNOWLEDGMENTS

The researchers would like to acknowledge and praise first and foremost our Almighty for giving us physical, mental, and emotional strength and knowledge.

The researchers warmly thank their parents for their support. Mr. Samboy D. Niala, for his comments and support.

6. REFERENCES

- Bacani Z. (2020). The Philippines Has A Policy Against Home Births. <https://www.npr.org/sections/goatsandsoda/2020/10/25/925442135/the-philippines-has-a-policy-against-home-births-its-not-playing-well-in-a-pande>
- Behruzi R. (2013). Understanding childbirth practices as an organizational cultural phenomenon: a conceptual framework. *BMC Pregnancy Childbirth*. <https://doi.org/10.1186/1471-2393-13-205>
- Grey E. (2016). Cultural Beliefs and Practices of Ethnic Fiiipinos: An ethnographic Study. *IRA-International Journal of Management & Social Sciences*. <http://dx.doi.org/10.21013/jmss.v3.n3.p30>
- Lamxay, V. (2011). Traditions and plant use during pregnancy, childbirth and postpartum recovery by the Kry ethnic group in Lao PDR. *J Ethnobiology Ethnomedicine*. <https://doi.org/10.1186/1746-4269-7-14>
- Matsubara C. (2013). Reliability tests and validation tests of the client satisfaction questionnaire (CSQ-8) as an index of satisfaction with childbirth-related care among women. *BMC Pregnancy Childbirth* 13, 235 (2013). <https://doi.org/10.1186/1471-2393-13-235>
- Withers M. and Lim E. (2018). Traditional beliefs and practices in pregnancy, childbirth and postpartum: A review of the evidence from Asian countries. <https://doi.org/10.1016/j.midw.2017.10.019>



An Ethnocultural Study on the Medical Practices of 'Magtatambal' in Tagkawayan, Quezon

Arnel Lenra M. Adulta and Angeline A. Adillo
Tagkawayan National High School, Tagkawayan, Quezon

Samboy D. Niala, Cherry S. Ona, *Advisers*
Tagkawayan National High School, Tagkawayan, Quezon

Abstract: 'Magtatambal' is a faith healer who specializes in curing animal bites. They have preserved medical cultures and practices in Tagkawayan, Quezon. This study used an ethnocultural type of qualitative research by utilizing interviews and observation. The subjects of the study were composed of three 'magtatambal': (1) 'magtatambal' in Barangay Aliji, (2) 'magtatambal' in Barangay Bamban, and (3) 'magtatambal' in Barangay Sta. Cecilia, Tagkawayan, Quezon. They were purposively selected because of their differences in the method of treating animal bites and are specifically identified as experienced 'magtatambal'. In the light of the findings, the researchers found out that 'magtatambal' 1 performs her medical practices by saying a Latin prayer, blowing air, and patting the body part bitten of the patient. 'Magtatambal' 2 performs her medical practices by washing the wound caused by the animal fangs using the 'tambal' (alcohol) and letting the victim drink one shot of the 'tambal'. Lastly, 'magtatambal' 3 conducts theirs by putting a boiled 'bolo' (bamboo stalk) to the wound that will extract the venom from the victim's body. The subjects encountered difficulty in handling patients who are already experiencing the effect of the venom. Passing the knowledge and the procedure is the subjects' way to preserve their practices.

Key Words: 'bolo'; 'Magtatambal'; 'tambal'; medical practices; ethnocultural

1. INTRODUCTION

1.1. Background of the Study

Humans have traditionally relied on nature to meet their essential needs, such as food, clothes, medicines, and natural healing remedies. Before, there were no high establishments, modern medical equipment, and further knowledge about medicine. It is impressive how diseased people are still able to survive without the things mentioned. Only traditional healing methods such as herbal ingestion, local incision, and prayers are given to its patients. The said procedures are done using traditional healing methods or sometimes termed as faith healing.

Faith healing is a method of medication in which a believer seeks divine intervention through praying to reconcile a particular ailment or condition. Since time immemorial, faith healing has been used by believers who adhere to different religions to heal diseases. Faith healers are the ones who conduct faith healing. Other than that, they have the ability to cure patients despite lacking the proper study from medicine. Usually, their knowledge came from their ancestors or was learned from their experiences.

A 'magtatambal' is a faith healer that can be

found in Tagkawayan, Quezon. They specialized in treating snakebites, rabies, and other poisonous animal bites. They only differ from the methods on how they treat their patients. The availability of this medical practice helped save the lives of many people. However, due to the modernization of medicine, faith healing is slowly fading, and much more to vanish if it will not be preserved. If people forget about this culture, it will be lost over time.

Snakebite is a serious medical, social, and economic problem in many parts of the world, especially in tropical and subtropical countries, home to most of the world's dangerous snakes and have limited access to treatment. In Vietnam, the majority of traditional healers inherited their family businesses and learned healing skills and expertise from their forefathers and foremothers. Also, the affordable treatment cost compared to modern medicine is one of the factors for local people to use their service continuously.

According to Peprah et al. (2018), in their research entitled "Religion and Health: exploration of attitudes and health perceptions of faith healing users in urban Ghana," faith healers served as the first port of call for disease curing and prevention for most users. Consumers of faith healing perceived their health status to be good due to the perceived



effectiveness of faith healing to cure health problems.

Traditional healers, however, are often neglected and left out from rabies prevention and control plans. Mental Floss UK (2018) stated the “cut and suck” method was discredited a few decades ago because research proved it to be counterproductive. They said that venom spreads to the victim’s system quickly, so there is no hope of sucking out a sufficient volume to make any difference as it can only increase the risk of infections.

The researchers pursue this study to explore their medical practices, to learn from their perspectives, and to understand their way of healing. This study will help determine the reliability of the said medical practices. Also, the study would help preserve the knowledge and culture of ‘pagtatambal’.

1.2. Statement of the Problem

The study would like to investigate the medical practices of ‘Magtatambal’ in Tagkawayan, Quezon. Specifically, it sought to answer the following questions:

1. What are the medical practices of the ‘Magtatambal’ in:
 - 1.1. Barangay Aliji, Tagkawayan, Quezon
 - 1.2. Barangay Bamban, Tagkawayan, Quezon, and
 - 1.3. Barangay Sta. Cecilia, Tagkawayan, Quezon?
2. What are the challenges encountered by the ‘Magtatambal’?
3. How do the ‘Magtatambal’ preserve their medical practices?

1.3. Significance of the Study

The study is beneficial to the faith healers to help them be recognized and preserve their culture and knowledge about treating patients. It would inform the community about alternative and natural processes used by the ‘magtatambal’. In addition, this study will give them enough information to understand better the traditions and cultures which their ancestors use. Also, the study might be helpful to the researchers pursuing similar studies as they can use this as a reference or guide.

1.4. Scope and Delimitation

The study focused on the medical practices of ‘magtatambal’ in Tagkawayan, Quezon. The study was conducted in Barangay Aliji, Bamban, and Sta. Cecilia. Each barangay inherent one ‘magtatambal’ who differs from one another by their medical practices. In connection, this study would determine the culture in doing the medical practice of the ‘magtatambal’ and help preserve it by giving value to

the practice and introducing it to the people.

1.5. Conceptual Framework

The researchers would like to study the ethnocultural about the medical practices of ‘magtatambal’ in Tagkawayan, Quezon.

In input, the researchers would gather the data from the selected ‘magtatambal’ in Tagkawayan, Quezon.

In process, the researchers would analyze, observe, and conduct an interview.

The output of the study is the medical practices in curing animal bites of ‘magtatambal’ in Tagkawayan, Quezon.

1.6. Definition of Terms

The following terms were conceptually and operationally defined:

Bolo is a bamboo stalk in Tagalog. This is one of the materials used in ‘pagtatambal’.

Medical practice is the practice of medicine by a group of physicians who share their premises and other resources. In this study, it is the term used for the medical process of the ‘magtatambal’ which is passed down from generation to generation.

Pagtatambal is the practice and culture of treating animal bites without the use of modern medical apparatus. Tambahal is the term that defines the main tool or equipment used by the ‘magtatambal’ to perform their medical practices.

2. METHODOLOGY

The study used an ethnographic type of qualitative research by utilizing interviews and observation. The findings of the study were based on the researchers’ observation and gathering of the information about the medical practices of the selected ‘magtatambal’ in the different barangays of Tagkawayan, Quezon. The researchers conducted the study in Barangay Aliji, Bamban, and Sta. Cecilia. An interview protocol was prepared to gather sufficient data for the study. Also, the researchers observed the actual medical practices of the ‘magtatambal’. The subjects of the study were composed of three ‘magtatambal’ in the selected barangays: one in Barangay Aliji, one in Barangay Bamban, and one in Barangay Sta. Cecilia. They were chosen purposively because of their differences in their medical practices, as well as their ability to articulate and describe their Ethnoculture.



3. RESULTS AND DISCUSSION

Table 1. Medical Practices Performed by the 'Magtatambal'

Subject	Answer	Code
Magtatambal A	"Ano...nilalapatan ng Latin [prayer]. Ano lang...hihipan yung mismong kinagatan. Hihip 'saka yung tapik lang siya." =	Praying Latin, blowing, and patting.
Magtatambal B	"Ayun...hinuhugasan ko ng tambal 'yung kinagatan bago patinumin ko [tambal]. Wala akong dasal". =	Pouring the wound. Drink 'tambal'.
Magtatambal C	"Magpapakulo ako ng tubig... 'pag tulong kulo na saka ko laang 'yung kawayan yung bolo...bago ipakapit dun sa ano... 'pag wala namang sugat at medyo tuyo na...inaamahan [hinihiwaan] ko...oo para may masipsipan. Yung blade." =	'Bolo'

Table 1 shows how the 'magtatambal' perform their medical practices. The subjects uttered that they perform their healing by: (1) praying Latin, blowing, and patting the area of the victim's wound; (2) pouring the liquor ('tambal') on the victim's wound for it to be cleaned, then, letting the patient drink a shot of 'tambal'; and lastly, (3) slitting a small piece of skin near the wound caused by the animal's bite and putting the boiled 'bolo' on the wound to sip the venom or rabies.

Mental Floss UK (2018) stated that venom spreads to the victim's system quickly, so there is no hope of sucking out a sufficient volume to make any difference. It can only increase the risk of infections.

Table 2. Tools and Equipment used in the Medical Practices

Subject	Answer	Code
Magtatamba 1A	"Latin [prayer] lang more on Latin...libro 'yun na isinalin sa 'kin. Ahh...galing pa 'yun sa ninuno ng...(pause)...kung bago ilang salin na ako kay ama...sa...tatay ni ama...tapos...siguro mga pang ano na ako eh pang...(pause)...pang-anim or pito. Bigay lang talaga 'yun...kasi 'yun... 'yun talaga naman ay dapat ay pansarili...kaso zyempre 'yung mga nakakaalam...kung bago sinasabi nang sinasabi kaya kung bago dumami 'yung mga nagpapagamot na rin. 'Pag ano lang, pagka Mahal na Arav, dasal, oo."	Latin prayers
Magtatamba 1B	"Tambal, oo 'yun laang. Ay bigay din laang yun sa amin...nilalagyan ko ulit ng alak...alak lang ang panlagay ko. Wala." =	Tambal
Magtatamba 1C	"Oo, bolo tapos pakulo ng tubig... bulak tapos, oo... 'baka blade." =	Bolo, boiled water, cotton, and blade

Table 2 presents the tools and equipment used by the 'magtatambal' in their medical practice. The first 'magtatambal' said that she only uses prayer, which is composed of Latin words. The last two subjects stated that they used alcoholic beverages and a 'bolo' boiled in water, cotton, and blade.

The Latin language is mostly used in faith healing from then until now as it possesses powerful entities used as a medium for communicating with spirits to seek guidance for faith healing. Using 'bolo' boiled in water removes unwanted bacteria that can affect the wound of the patient, and using alcohol is believed to be a good first aid for snakebite to dissolve the venom.

The use of alcohol to dissolve venom is questioned as it can affect the circulation of blood and the lymphatic system and can make the venom climb to the brain faster, leading to death. However, Hall (2018) supported that the use of alcohol can dissolve venom.

Table 3. Summary of the Subjects' Answers in the Interview

Questions	Summary of Answers
1. Where did you obtain your knowledge? Did you study the process of treating animal bites? How long? Did someone give you the process?	It was inherited from their great grandfather, husband, and taught by her mother-in-law.
2. Do you also prescribe medicine, either herbal or chemical, after you treat your patient? If yes, what are those?	They do not prescribe any medicine except for Amoxicillin (antibiotics).
3. Do you perform rituals?	One of the 'magtatambal' performs a ritual and offers prayers during Holy Week while others do not.
4. Have you experienced treating other animal bites? If yes, what are those?	They all treat animal bites, including dogs, cats, and rats.
5. How would you know if the venom or rabies are extracted? What are the signs?	The venom has been extracted from the body if the victim's body is no longer numb, something watery and sticky came out, and the 'bolo' or 'tambal' was placed on the victim's body twice.
6. What are the problems you encounter?	They experience difficulty in handling patients who are already experiencing the effect of the venom.

Table 3 shows the summary of the subject's answers in the interview. Their medical practices are mostly inherited and taught by their relatives and they only prescribe Amoxicillin (antibiotics). Only one of them performs a ritual, but they all treat other animal bites, including dogs, cats, and rats. The indicator that the venom is fully extracted is when the patient's body is no longer numb, a liquid substance came out, and the 'tambal' was placed twice on the affected area. The 'magtatambal' finds the treatment challenging if the patient is already suffering from the effects of the venom.

4. CONCLUSIONS

In the light of the findings, the researchers found out that 'Magtatambal' 1 performs her medical practice by saying a Latin prayer, blowing air, and patting the body part bitten of the patient. 'Magtatambal' 2 performs her medical practice by washing the wound caused by the animal fangs using the 'tambal' (alcohol) and letting the victim drink one shot of the 'tambal'. Lastly, 'Magtatambal' 3 conducts theirs by putting a boiled 'bolo' (bamboo stalk) to the wound that will extract the venom from the victim's body. They usually encounter difficulty in handling patients who are already suffering from the effects of the venom. Passing the knowledge and the procedure is the subjects' way to preserve their healing. Knowing and understanding these medical practices helps in appreciating the knowledge and culture of Filipinos. This is an important part of history that defines who Filipinos are, and this traces back to the strong belief in the faith of the Filipinos.

5. ACKNOWLEDGMENTS

The researchers would like to acknowledge and praise, first and foremost, our Almighty God for



giving us physical, mental, and emotional strength and knowledge.

The researchers warmly thank their parents for their spiritual, moral, and financial support and Mr. Samboy D. Niala and Ms. Cherry S. Ona for their critical comments and support.

6. REFERENCES

- Cherry, K. (2021, February 20). History and Key Concepts of Behavioral Psychology.
<https://www.verywellmind.com/behavioral-psychology-4157183>
- Faith healer definition and meaning | Collins English Dictionary. (n.d.).
<https://www.google.com/amp/s/www.collinsdictionary.com/amp/english/faith-healer>
- FAO.org. (n.d.).<https://www.fao.org/in-action/ectadvietnam/news/detail/en/c/385176/>
- Levin, J. et al. (2011). Prevalence and Sociodemographic Correlates of Spiritual Healer Use:
Findings from the National Survey of American Life.
<https://www.ncbi.nlm.nih.gov/pmc/articles/PMC3090998>
- The Editors of Encyclopedia Britannica. (2016). Faith healing.
<https://www.britannica.com/topic/faith-healing>
- The Pinoy Warrior. (n.d.). Filipino Traditional Healing.
<http://www.thepinoywarrior.com/2012/09/?m=1>



Feasibility of Unwaxed and Waxed Banana (*Musa acuminata x balbisiana*) Pseudostem Fibers as Alternative Dental Floss Material

Marianne Loren P. Celedonio, Nicole R. Arguelles, Mohit J. Amarnani,
Katelynn L. Cancio, Maxine H. Darwin, Alyssa Pauline C. Esmabe,
Allen Andrei R. Makasakit, Ailyn B. Anglo-Ojeda, and Fritz M. Ferran
De La Salle Santiago Zobel School - Vermosa Campus, Imus City, Cavite

Abstract: Oral health, waste management, and sustainability are prevalent issues faced by developing countries. Relative to these concerns, there remains a need for oral hygiene essentials that are both effective and environmentally responsible. This study aims to explore the feasibility of banana pseudostem fibers (BPF) as an alternative material for sustainable dental floss in terms of two physical properties, namely, tensile strength and elongation at break. Fibers were mechanically extracted from the outermost sheaths of banana pseudostems to produce two sample groups, unwaxed BPF and waxed BPF, the latter comprising fibers that were coated with a mixture of two parts coconut oil and one part candelilla wax. Both sample groups were tested for tensile strength and elongation at break. According to the mean and SD of both groups and one-way MANOVA, unwaxed BPF had significantly higher tensile strength and elongation at break than waxed BPF, revealing that the wax coating process diminished the physical properties of the BPF due to thermal degradation. Furthermore, the application of the coconut oil-candelilla wax coating was found to have a large effect on tensile strength and a small effect on elongation at break. Results show that there is potential in BPF to be an alternative material for dental floss in relation to the examined properties, although it may not be a substitute for synthetic dental floss material by itself. Modifying the fiber extraction and wax coating processes involved and assessing the chemical properties of the material are also recommended for further research.

Key Words: banana pseudostem fibers; candelilla wax; coconut oil; dental floss; sustainability

1. INTRODUCTION

Oral hygiene is a common problem amongst the youth, and the issue is amplified among those in rural areas. One study explores oral health perceptions and dental care behaviors among such rural adolescents, enumerating several difficulties regarding dental care access such as finances, transportation, fear, issues with health insurance, and parental responsibility (Dodd et al., 2014). The aforementioned factors that impede the attainment of good oral health are further augmented in the case of low-income communities in poor developing countries. Many of these communities do not have sufficient income to acquire oral health, nor do they have immediate access to such.

A greater extent of knowledge on oral health promotion was equated to a greater frequency of tooth brushing and dental flossing (Akpabio et al., 2008). Even then, most oral hygiene essentials such as toothbrushes and dental floss make use of plastic, which has constantly been reported to be dangerous not just to the environment but also to human health. While some studies and inventions attempted to

develop commercially sold oral hygiene essentials into more sustainable commodities, most of the resulting products only partially consist of biodegradable materials. Hence, the purpose of this study is to explore possible alternative materials that may be used in creating an oral hygiene essential that is not only completely biodegradable but can also be produced through sustainable methods.

2. LITERATURE REVIEW

Dental floss or dental tape is one of the commonplace instruments used in oral hygiene. At its simplest, it is a filament (or a bundle of filaments) that fits between two teeth for the removal of material. Burch (1995) states that the tensile strength of dental floss significantly affects its durability and efficacy. To reduce the risk of gum injury from flossing, some variants of dental floss are coated with wax to decrease the coefficient of friction. Submergence techniques are commonly employed to ensure that each fiber is evenly coated. Following this, the excess coating is removed, and the floss threads are dried to solidify the wax coating and prevent contamination

(Tseng et al., 2000). Standard dental floss waxing usually requires a wax that has a melting point between about 57°-93°C, such as beeswax, paraffin, candelilla, and microcrystalline waxes (Evazynajad & LeGrande, 2006).

Most studies geared toward the development of sustainable dental floss have utilized silk as the raw material, while others modified the components of the wax coating instead of the floss material itself. Table 1 displays a summarized comparison among several forms of dental floss.

Table 1. Comparison of Dental floss from other Studies

Author	Dental floss material	Tensile strength (N)	Elongation at break (%)
Phonhan et al., 2014	Thai silk (Nang noi), waxed	15.65	28.5
	synthetic unwaxed (nylon)	47.39	31.25
Supanitayanon et al., 2017	synthetic waxed (nylon)	46.46	44.62
	Thai silk, waxed	23.70	16.44
	synthetic ^a	2.56–50.70	7.69–53.96
Suwansanit, 2009	Thai silk, unwaxed	24.2 ± 6.5	11.5 ± 1.7
	Thai silk, waxed	20.4 ± 2.8	23.9 ± 7.0
Tseng et al., 2000	synthetic	14.61–32.56	N/A

^a From seven kinds of commercial dental floss

Banana fiber is a lignocellulosic fiber, which is obtained from the pseudostem of banana plants. Banana fiber has good strength properties comparable to those of conventional materials such as glass fiber. It is lightweight and sustainable and has a high level of strength, smaller elongation, and better fire resistance (Bhatnagar et al., 2015). In terms of fiber extraction and processing, Subagyo and Chafidz (2018) identified three main steps: 1) tuxing, which refers to the manual or mechanical removal of the fiber bundles from the pseudostem layers; 2) retting, which involves water absorption and microbial activity to decompose pectin, the substance which binds the fibers to the woody center of the pseudostem, and; 3) degumming, which entails the boiling and washing of fibers to neutralize them, remove impurities, and break them down into smaller filaments (Ebisike et al., 2013).

From reviewing existing literature, the proposed product is a wholly sustainable alternative material for dental floss made primarily out of banana pseudostem fibers (BPF) and coated with a natural wax.

3. CONCEPTUAL FRAMEWORK

As shown in Figure 1, the research involves one independent variable: the application of the coconut oil-candelilla wax coating. Additionally, two dependent variables represent physical properties to be measured: 1) tensile strength and 2) elongation at break.

Previous studies have demonstrated that

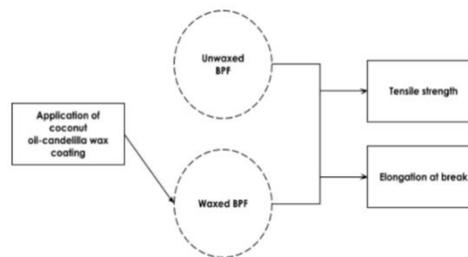

Figure 1. Diagram of Conceptual Framework

plant fibers are a feasible alternative raw material for dental floss in terms of physical properties. The most relevant of these properties are tensile strength and elongation at break, which are both thoroughly associated with dental floss efficacy. Among several natural fibers, the intrinsic physical characteristics of BPFs—which the chemical compounds cellulose and lignin are responsible for—make them ideal substitutes to synthetic polymers such as nylon (Subagyo & Chafidz, 2018) and, therefore, appropriate for the experimental dental floss material. However, a certain intervention is required to improve the elongation of banana fibers.

According to Suwansanit (2009), the presence of a wax coating can significantly increase the elongation of dental floss. The utilization of BPF for the experimental dental floss material in this study leads the researchers to assume that the effect of a wax coating on dental floss might also be applicable to plant fibers, at least in part. Hence, the application of a wax coating will be the intervention done on BPF to increase their elongation at break and, at the same time, emulate the components found in standard dental floss. In addition, coconut oil and candelilla wax are the chosen wax mixture ingredients for these reasons: their antimicrobial properties (Peedikayil et al., 2015), their average melting point that meets the minimum requirement for dental floss wax, and their recurrent use in both experimental and commercially available dental floss as a substitute for synthetic waxes.

4. STATEMENT OF THE PROBLEM

1. What is the effect of the utilization of banana pseudostem fibers (BPF) and the application of the coconut oil-candelilla wax coating on the tensile strength and elongation at break of the unwaxed and waxed BPF?

2. Is there a significant difference in tensile strength and elongation at break between the unwaxed BPF and waxed BPF?

5. METHODOLOGY

This study utilized an experimental research design comprising two sample groups: 1) unwaxed



BPF or manually extracted banana pseudostem fibers and 2) waxed BPF or manually extracted banana pseudostem fibers coated with the coconut oil-candelilla wax.

Banana pseudostems and coconuts were procured from a local farm and market. Candelilla wax was purchased from a cosmetics supplier. Other necessary materials were provided by the researchers to account for the unavailability of laboratories. A research ethics checklist and request letter for data gathering were also submitted for permission to conduct the methods at home.

The outer sheaths were separated from the inner layers of the pseudostem by hand. For each sheath, the non-fibrous internal layer was pulled from the fibrous external layer with a knife. The trimmed fibrous layers were boiled for 45 minutes then repeatedly scraped to be separated into individual strands. These fibers were washed with distilled water and left to dry overnight. After, the fibers were randomly grouped into two, corresponding to the two sample groups—unwaxed BPF and waxed BPF. Then, oil was extracted from fully mature coconuts using the hot extraction method (Agarwal & Bosco, 2017). The coconut oil was mixed with candelilla wax in the ratio 2:1, respectively, and heated through a bain-marie at 80°C. Fibers for the waxed BPF group were immersed in the heated wax mixture, then transferred one by one to a parchment-lined tray. Finally, samples were packaged and delivered for testing through the ASTM D 3822 method.

Data were later organized in Excel prior to statistical treatment.

6. DATA ANALYSIS

Data were analyzed through mean and standard deviation comparison and one-way MANOVA with the aid of IBM SPSS Version 24 software.

7. RESULTS AND DISCUSSION

7.1 Effects of BPF utilization and wax application on the physical properties of the experimental dental floss material

Sixty-four cases were examined for each group (n=64). As seen in Table 2, unwaxed BPF has higher tensile strength (M = 11.96, SD = 3.52) than waxed BPF (M = 4.63, SD = 1.54). Similarly, the elongation at break of unwaxed BPF (M = 3.77, SD = 0.73) is higher than that of waxed BPF (M = 3.01, SD = 1.35).

Both unwaxed and waxed BPF possess lower tensile strength and elongation compared to most commercially sold dental floss, as well as experimental dental floss from previous studies.

Table 2. Descriptives

Material for Sustainable Dental Floss (BPF)	n	Tensile Strength (N)		Elongation at Break (%)	
		M	SD	M	SD
unwaxed BPF	64	11.96	3.52	3.77	0.73
waxed BPF	64	4.63	1.54	3.01	1.35

Remarks: Mean tensile strength and elongation at break only describe the physical properties of the samples and are not indicative of their possible effects on users (e.g. regarding safety, preference).

Frequently exposing the fibers to water during the extraction procedures may have reduced fiber extension (Subagyo & Chafidz, 2018). A multicomponent polymer dental floss developed by Tseng et al. (2000) had a break strength in the range of 14.61–32.56 N, the minimum value of which is relatively close to the unwaxed BPF's mean tensile strength of 11.96 N. What makes this comparison interesting is that the polymer dental floss and unwaxed BPF have nearly similar tensile strengths despite the former comprising synthetic material and a larger number of filaments than the latter, suggesting that there are merits to unwaxed BPF. Statistical analysis shows that unwaxed BPF had better tensile strength and elongation at break than waxed BPF, which indicates that the application of the coconut oil-candelilla wax coating had an adverse effect. This is contrary to what was previously believed, particularly that the wax would significantly improve elongation (Supanitayanon et al., 2017; Suwansanit, 2009). A primary reason for the negative effect of the wax application may be the thermal degradation of BPF, which takes place at 30–144°C. Submerging the fibers at a temperature of 80°C during the wax coating process led to physical deterioration due to the evaporation of moisture from the fibers (Alwani et al., 2014, as cited in Subagyo & Chafidz, 2018).

7.2. Feasibility of unwaxed and waxed BPF as an alternative dental floss material

Table 3. Multivariate Tests and Test Between-Subjects Effects

Effect	Value	F	Hypothesis df	Error df	Sig.	Partial Eta Squared ^d
Group: Unwaxed and waxed BPF	Pillai's Trace .649	115.572	2.000	125.000	.000	.649
	Wilks' Lambda .351	115.572	2.000	125.000	.000	.649
Dependent Variable	Type III Sum of Squares	df	Mean Square	F	Sig.	Partial Eta Squared ^d
Tensile Strength	1719.911	1	1719.911	232.790	.000	.649
Elongation at Break	18.369	1	18.369	15.665	.000	.111

a. Design: Intercept = unwaxed and waxed BPF

b. Adjusted statistic

c. Each F tests the multivariate effect of Group. These tests are based on the linearly independent pairwise comparisons among the estimated marginal means

d. Partial eta squared can be cited as a measure of effect size: f^2 is Cohen's effect size: .02 = small, .13 = moderate, .35 = large

Table 3 presents a significant difference in tensile strength and elongation at break between unwaxed and waxed BPF $F(2, 125) = 115.572, p < 0.05$, Pillai's Trace = 0.649, partial $\eta^2 = 0.649$. Furthermore, the application of the coconut oil-candelilla wax coating had a large impact on tensile



strength (partial 2 = 0.649) and a small effect on elongation at break (partial 2 = 0.111).

Results correspond with those of Phonhan et al. (2014) despite varying floss material, although few works offer justification. In this study, at least, it can be inferred that the discrepancies in data are not solely a consequence of the wax application but are also attributed to the intrinsic physical characteristics of BPF. Jayaprabha et al. (2011) found that banana fibers across various pseudostem layers differed far more in maximum force sustained than they did in elongation, hence the larger discrepancy in tensile strength and the smaller discrepancy in elongation between the two BPF samples. Nonetheless, theoretical explanations must be considered, as the experiment is only limited to two physical properties. It is possible that what the waxed BPF samples lack in physical properties is compensated for in other areas such as user experience, refined fiber surface (Supanitayanon et al., 2017; Reddy & Yang, 2005), and antimicrobial properties (Peedikayil et al., 2015; Darby & Walsh, 2010).

In light of existing literature, it can be deduced that the less favorable physical properties of waxed BPF are not necessarily a consequence of the wax coating itself, but rather of the process by which the wax was applied to the fibers. On its own, BPF may not be a suitable substitute for conventional dental floss material and would need to be supplemented with some sort of synthetic ingredient or treatment to meet the criteria for standard dental floss. Even so, it is safe to conclude that when met with the exact conditions provided by the research, there is potential for BPF to be further developed into an alternative material for dental floss that is not only on par with conventional materials but is also sustainable and environment-friendly.

8. CONCLUSIONS

In summary, unwaxed BPF possesses significantly higher tensile strength and elongation at break than waxed BPF. The adverse effect of the wax application on the physical properties of the BPF is not necessarily because of the wax itself, but rather of the wax coating process employed, wherein exposure to a certain temperature led to the thermal degradation of the fibers. Information derived from existing literature shows that, while unwaxed BPF has better physical properties, waxed BPF is not entirely unfeasible due to the added benefits provided by the application of wax. By itself, BPF may not be a suitable replacement for commercially available dental floss, but modifying the processes involved in this research may further develop BPF into a comparable and sustainable alternative to conventional dental floss material. It is worth noting, though, that the scope of this discussion is limited, as

it only entails two physical properties for variables. For future studies, combining banana fibers with another synthetic or natural ingredient and developing banana fiber-derived plastics may lead to more feasible products. Analyzing chemical and antimicrobial properties is also recommended.

9. ACKNOWLEDGMENTS

We are thankful to Mr. Gerald Gamboa for being one of our statistical consultants and Ms. Airah Marie Valles for helping us refine the structural and grammatical aspects of this paper. We would also like to express our immense gratitude to the Philippine Textile Research Institute (DOST-PTRI) for extending its services to us during the data gathering process.

10. REFERENCES

- Agarwal, R. K., & Bosco, S. J. D. (2017). Extraction processes of virgin coconut oil. *MOJ Food Processing & Technology*, 4(2), 00087.
- Akpabio, A., Klausner, C. P., & Inglehart, M. R. (2008). Mothers'/guardians' knowledge about promoting children's oral health. *American Dental Hygienists' Association*, 82(1), 12.
- Bhatnagar, R., Gupta, G., & Yadav, S. (2015). A review on composition and properties of banana fibers. *Cellulose*, 60, 65.
- Bourgeois, D. M., & Llodra, J. C. (2014). Global burden of dental condition among children in nine countries participating in an international oral health promotion programme, 2012–2013. *International Dental Journal*, 64, 27-34. <https://doi.org/10.1111/idj.12129>.
- Burch, R. R. (1995). Dental floss based on robust segmented elastomer (U.S. Patent No. 5,433,226). Washington, DC: U.S. Patent and Trademark Office. <https://patents.google.com/patent/US5433226A/en>.
- Darby, M.L. and Walsh, M. (2010). *Dental hygiene: Theory and practice*. Elsevier.
- Dodd, V. J., Logan, H., Brown, C. D., Calderon, A., & Catalanotto, F. (2014). Perceptions of oral health, preventive care, and care-seeking behaviors among rural adolescents. *Journal of School Health*, 84(12), 802-809. <https://doi.org/10.1111/josh.12215>.



- Ebisike, K., AttahDaniel, B. E., Babatope, B., & Olusunle, S. O. O. (2013). Studies on the extraction of naturally-occurring banana fibers. *The International Journal of Engineering and Science*, 2(9), 95-99.
- Evazynajad, A., & LeGrande, W. E. (2006). Dental floss coated with soywax (U.S. Patent Application No. 11/204,453). <https://patents.google.com/patent/US20060118131A1/en>.
- Jayaprabha, J. S., Brahmakumar, M., & Manilal, V. B. (2011). Banana pseudostem characterization and its fiber property evaluation on physical and bioextraction. *Journal of Natural Fibers*, 8(3), 149–160. doi:10.1080/15440478.2011.601614.
- Peedikayil, F. C., Sreenivasan, P., & Narayanan, A. (2015). Effect of coconut oil in plaque related gingivitis—A preliminary report. *Nigerian Medical Journal: Journal of the Nigeria Medical Association*, 56(2), 143. <https://dx.doi.org/10.4103%2F0300-1652.153406>.
- Phonhan, C., Yangyuen, S., & Wongkasem, S. (2014). The Design and Development of Machine for Producing the Natural Dental Floss. *Procedia Engineering*, 69, 751-757. <https://doi.org/10.1016/j.proeng.2014.03.051>.
- Reddy, N., & Yang, Y. (2005). Biofibers from agricultural byproducts for industrial applications. *Trends in Biotechnology*, 23(1), 22-27. <https://doi.org/10.1016/j.tibtech.2004.11.002>.
- Rojas-Molina, R., De León-Zapata, M. A., Saucedo-Pompa, S., Aguilar Gonzalez, M. A., & Aguilar, C. N. (2013). Chemical and structural characterization of Candelilla (*Euphorbia antisiphilitica* Zucc.). *Journal of Medicinal Plants Research*, 7(12), 702-705. <https://doi.org/10.5897/JMPR11.321>.
- Subagyo, A., & Chafidz, A. (2018). Banana pseudo-stem fiber: Preparation, characteristics, and applications. In *Banana Nutrition-Function and Processing Kinetics*. IntechOpen. doi:10.5772/intechopen.82204.
- Supanitayanon, L., Dechkunakorn, S., Anuwongnukroh, N., Sriksirin, T., Roongrujimek, P., & Tua-ngam, P. (2017). Mechanical and physical properties of various types of dental floss. *Key Engineering Materials*, 730, 155-160. <https://doi.org/10.4028/www.scientific.net/KEM.730.155>
- Suwansanit, T. (2009, September 23). Physical properties of dental floss made from Thai natural silk [Poster session]. 2009 Asia/Pacific Region Meeting, Wuhan, China. <https://iadr.abstractarchives.com/abstract/papf09-125132/physical-properties-of-dental-floss-made-from-thai-natural-silk>.
- Tseng, M. M., Masterman, T. C., Park, E. H., Roberts, M. F., & Spencer, J. L. (2000). Dental floss (U.S. Patent No. 6,027,592). Washington, DC: U.S. Patent and Trademark Office. <https://patents.google.com/patent/US6027592A/en>.



Hybrid Pigments Based on Anthocyanins and Clay Minerals: A Mini Review

Greg Antonio O. Abines, Noah H. Bernardo, Gwyneth Venice S. Santos,
and Kathleen O. Tesalona

De La Salle University Integrated School, Manila

Abstract: The synthesis of hybrid pigments has been studied as these provide a safer alternative to modern synthetic pigments that are stable but are unsafe. This paper provides a systematic review of previous research on hybrid pigments composed of anthocyanins combined with different mineral clays, particularly saponite, montmorillonite, halloysite, palygorskite, and sepiolite. The research was carried out by summarizing the related literature cited and comparing each paper to another by the processes that were used and interactions that occurred in creating the hybrid pigment. The findings showed that the literature cited used adsorption as the method of combining the anthocyanin dye and the mineral clays used; the interactions that occurred were the intercalation of the dye and stabilizer used. Additionally, it was shown that the hybrid pigments exhibited improvement with respect to their stability in different areas, particularly pH, chemical, thermal, color, and light stability. Overall, the paper has shown the development and improvement in hybrid pigment research, particularly with anthocyanin hybrid pigments.

Key Words: hybrid pigments; anthocyanins; clay minerals

1. INTRODUCTION

Pigments have played an important role in multiple industries, particularly the food, automotive, plastic, and paint industries (Bruni et al., 2019). Natural pigments are organic pigments derived from organic sources such as plants, animals, and fungi (Dufosse, 2014). These plant-based natural dyes and pigments are useful but are unstable, meaning they are susceptible to fading and possess poor colorfastness (Kasiri & Safapour, 2013). Synthetic inorganic pigments are used in different applications across different industries for their incredible stability, although their disadvantage is their toxicity (Venil & Lakshmanaperumalsamy, 2009). With these in mind, the synthesis of hybrid pigments has been studied as hybrid pigments are a combination of the qualities of both organic and inorganic materials.

In order for a hybrid pigment to be produced, a natural pigment source will have its dye extracted through different methods. After the dye is extracted, another set of processes is done to combine the dye and the inorganic material, such as a binder or a stabilizer. It is incorporated into the composition of the pigment to improve the quality of the colorant, making a hybrid pigment in the process (Li et al., 2019). Current research papers have shown different results depending on the materials used and the processes involved in creating the hybrid pigment.

The information produced by each paper contributes to the existing body of knowledge

regarding hybrid pigments, although papers which summarize these research papers for convenience are not common. The research gap presents itself, as there is a need for organized information and knowledge regarding hybrid pigments. This paper aims to summarize past research regarding the production of hybrid pigments and discuss the processes, chemical interactions, and results of the cited literature.

As discussed, organic pigments are environmentally friendly and safe to use compared to inorganic pigments that are more stable but harmful. Hybrid pigments are created to combine the stability and safety of both, although there is a lack of organized information regarding hybrid pigments. The objective of this research is to address the following research statements:

- Identify past research that discusses hybrid pigments created with anthocyanins and different stabilizers.
- Determine the processes and chemical interactions brought about by the experimentation.
- Compare the pigments produced based on the processes, safety, and stability given the information gathered from past research.

The paper discusses different research done in the past regarding hybrid pigments, which will involve the combination of a dye or colorant, specifically anthocyanin, stabilizers including saponite, montmorillonite, halloysite, palygorskite, and sepiolite. The paper will only cover descriptions of



the materials, processes involved in creating hybrid pigments, interactions between the anthocyanin and the stabilizer, and results from each of the experiments performed. The research will be done to help gather the existing knowledge into one paper which would serve as a review of literature for the research papers used and cited. This would help add convenience to future researchers, as the summary paper will help provide the necessary information needed by the researchers to gain a better understanding of hybrid pigments, particularly those made using anthocyanin as the dye material and stabilizers previously mentioned.

2. COMPARISON RESEARCH

The research was carried out by gathering and summarizing multiple research papers regarding hybrid pigments specifically made with anthocyanin dyes and clay minerals such as saponite, montmorillonite, halloysite, palygorskite, and sepiolite. The papers were sourced from different articles and journals from websites such as Google Scholar, ResearchGate, and ScienceDirect.

Anthocyanins were chosen due to their versatility in a variety of applications as well as their abundance in the environment. These compounds exhibit the potential as better industrial colorants, health supplements, and as a component in the development of solar-based, renewable energies (Silva et al., 2017). Singh et al. (2018) cite that anthocyanins are extracted from numerous sources, including flowers, fruits, vegetables, and leaves, thus being a renewable resource.

The clay minerals used were chosen based on the availability of papers that used anthocyanin dyes in creating the hybrid pigment. According to Trigueiro et al. (2018), clay minerals have layered structures and are capable of ion exchange, thus being useful as stabilizing agents for anthocyanins. The ion exchange capacity contributes to the intercalation process with the help of intermolecular forces. The research studies cited were compared to each other by determining the process used in combining the dye and stabilizer, the

Table 1. Summary of Cited Research based on Processes Used and Interactions

Hybrid Pigment	Stabilizer (Reagents Used)	Processes Used	Interactions	Researchers
(1) anthocyanin-saponite	modified saponite (saponite + cetyltrimethylammonium bromide (CTAB))	Adsorption	Intercalation	Lima, Castro-Silva, Silva-Filho, Fonseca, & Jabier (2020)
(2) anthocyanin-saponite	modified saponite (deionized water + hydrofluoric acid + sodium acetate + magnesium acetate tetrahydrate + basic aluminum acetate + silica)	Adsorption	Intercalation	Lima, Silva, Silva-Filho, Fonseca, Zhuang, & Jabier (2020)
(3) anthocyanin-saponite	synthetic saponite (methanol + hydrochloric acid)	Adsorption	Intercalation	Ogawa, Takee, Okabe, & Seki (2017)
(4) anthocyanin-montmorillonite, anthocyanin-halloysite	montmorillonite and halloysite	Adsorption	Intercalation	Li, Mu, Wang, Kang, & Wang (2019)
(5) anthocyanin-montmorillonite	montmorillonite	Adsorption	Intercalation	Ribeiro, Oliveira, Brito, Ribeiro, Souza, Filho, & Azeredo (2018)
(6) anthocyanin-palygorskite	palygorskite	Adsorption	Intercalation	Li, Ding, Mu, Wang, Kang, & Wang (2019)
(7) anthocyanin-sepiolite	sepiolite	Adsorption	Intercalation	Silva et al. (2019)

interactions that occurred, as well as the characteristics of the pigment produced and its applications.

Table 1 shows a summary of the different research papers cited in this paper. It is noted that several reagents mentioned in the table are modified versions of existing clay minerals to improve the quality of the hybrid pigment further. Adsorption, a process in which a dye and stabilizer solution is centrifuged and left out to dry for the dye to adhere to the stabilizer's surface, is the method commonly used in the cited studies to combine the anthocyanin pigment with the stabilizers (Britannica, 2013). This was the chosen method as clays have high adsorption capacity and are capable of ion-exchange (Trigueiro et al., 2018). The adsorption process, despite being done with different clay minerals, exhibited the same interaction throughout. As explained in a paper by Lagaly, Ogawa, and Dékány (2012), intercalation occurs when molecules from a compound penetrate another compound's layers. In this case, the anthocyanin dyes intercalated into the mineral clays' layers in each of the respective research to form hybrid pigments. Dipole forces attract both the dye and clay together, causing deformation in the interlayers by slowly widening the space between two clay layers. Once the space is large enough, the rest of the dye molecules enter the interspace, combining with the clay and forming a hybrid pigment.

Table 2. Summary of Cited Research based on Characteristics, Color, Stability, and Application of Pigments

Hybrid Pigment	Characteristics of Pigment	Pigment Color	Stability	Applications
(1) anthocyanin-saponite	Pigment is able to change color by manipulating pH level of the environment	pink/blue	Exhibited good stability against visible light and basic pH conditions	Atmospheric acidity sensor
(2) anthocyanin-saponite	Pigment is able to change color by manipulating pH level of the environment; pigment is observed to be environmentally friendly	pink/blue	Exhibited good stability against visible light and basic pH conditions	Atmospheric acidity sensor
(3) anthocyanin-saponite	Pigment is able to change color by manipulating pH level of the environment	light pink/light blue	Exhibited good pH stability	Color-changing advanced pigment
(4) anthocyanin-montmorillonite, anthocyanin-halloysite	Pigment is able to change color by manipulating pH level of the environment	dark brown/ light browns and pale red/ light yellow, respectively.	Exhibited good thermal and chemical stability	pH indicators
(5) anthocyanin-montmorillonite	Higher concentrations of montmorillonite contribute to more stability.	red/dark red	Improved pH and color stability	Anthocyanin-based colorants
(6) anthocyanin-palygorskite	Pigment exhibited excellent acid/base allochromic behavior	bright pink/steel gray	Exhibited thermal and chemical corrosion resistance	Intelligent film that can detect the freshness of food
(7) anthocyanin-sepiolite	Hue, color, and stability of pigments are pH dependent	peach, orange, green, light purple, and yellow	Improved color and thermal stability	Fluorescent hybrid pigments

Table 2 shows a summary of the cited research, specifically on the characteristics of and stability of the pigments produced. It was observed that most of the pigments produced are affected by the pH level. The research cited showed that a color change occurs when the pH level is manipulated wherein the process was carried out by exposing the



hybrid pigment in an acidic atmosphere using hydrochloric acid (HCl) and then exposing it in a basic atmosphere using either ammonium hydroxide (NH₄OH) or ammonia (NH₃) for at least 6 to 10 minutes per exposure in a desiccator. Li et al. (2019) used slow oscillation at 70 revolutions per minute (rpm) for 24 hours at room temperature after applying the pigment into 10mL of hydrochloric acid and 10mL ammonium hydroxide, respectively. Silva et al. (2019) used sodium borate buffer solutions with a pH level of 10 and sodium acetate buffer solutions with pH levels of 4, 5, and 6 that were mixed with a sample of the pigments made and was stirred for 24 hours and was centrifuged and dried. This characteristic contributes to the overall stability of the pigment, particularly the chemical and pH stability of the produced pigment. It was also observed in the research done by Lima et al. (2020) that the pigments were environmentally friendly, making them a potentially useful pigment in terms of sustainability and safety. This is due to hybrid pigments possessing the carbon-based structures of natural pigments which are considered to be environmentally friendly as these do not generally include heavy metals or similar chemicals that are toxic and can cause damage to the environment but at the same time, possessing the stability and durability of inorganic materials (Bruni et al, 2019; Ebrahimi & Gashti, 2015; Li et al 2019). Ribeiro et al. (2020) mentioned that higher concentrations of montmorillonite contribute to more stability, which was observed throughout the experimentation.

The colors exhibited by the hybrid pigments made in each of the research varied across the research cited. It was observed in anthocyanin-saponite hybrid pigments produced in the research done by Lima et al. (2020a), Lima et al. (2020b), and Ogawa et al. (2017) that the colors exhibited by the hybrid pigment were pink or blue, although the pigment exhibited by Ogawa et al. (2017) was shown to exhibit lighter variants of the colors mentioned. The colors of the pigments are capable of changing from pink to blue depending on the pH level, wherein the hybrid pigment becomes pink when exposed to an acidic environment or blue when exposed to a basic environment. This principle also applies to the pigments produced by Li et al. (2019a) which exhibited dark brown or light brown colors for the anthocyanin-montmorillonite hybrid pigment and pale red or light-yellow colors for the anthocyanin-halloysite hybrid pigment; Ribeiro et al. (2018) which exhibited red or dark red colors for the anthocyanin-montmorillonite hybrid pigment and Li et al. (2019b) which exhibited bright pink or steel gray colors for the anthocyanin-palygorskite hybrid pigment. Lastly, the pigment produced by Silva et al. (2019) showed a variety of colors which included peach, orange, green, light

purple, and yellow, as the pigments produced in this research were aimed to be bright and fluorescent, hence the large variety of colors. The differences in colors were mainly due to the different sources of anthocyanins used in each of the respective research cited.

All pigments have exhibited better stability in different aspects. The anthocyanin-saponite hybrid pigments by Lima et al. (2020a), Lima et al. (2020b), and Ogawa et al. (2017) have shown to be resistant to degradation due to pH changes in the environment as well as light. The anthocyanin-montmorillonite hybrid pigments by Li et al. (2019a) and Ribeiro et al. (2018) have shown improvements with thermal, chemical, light, pH, and color stability based on the cited research. The anthocyanin-halloysite hybrid pigment by Li et al. (2019a) has shown improved pH and color stability. The anthocyanin-palygorskite hybrid pigment by Li et al. (2019b) has shown stability against heat and chemical erosion. Lastly, the anthocyanin-sepiolite hybrid pigment by Silva et al. (2019) exhibited improved color and thermal stability. Each of the different improvements in stability was observed from the testing carried out in each of the research. The improvement in pH stability was noted due to the reversible behavior of pigments in terms of color-changing ability, wherein the pigments can change from one color to another and vice versa by exposing the pigment in an acidic or basic atmosphere. The improvement in light, thermal, and color stability was noted due to the decreased amount of fading or destruction under the light of the hybrid pigment. The increased stability is due to the inorganic component of the hybrid pigments, which were combined with the natural pigment through the methods mentioned. With the intercalations that occurred in the process, the mineral clays used were able to create another layer of protection which improved the overall stability of the hybrid pigment.

The pigments produced in the cited literature are shown to be useful in different applications. The saponite hybrid pigments are applicable as color-changing pigments as well as atmospheric acidity sensors. The montmorillonite hybrid pigments are useful as lake pigments, pH indicators, or colorants. The halloysite hybrid pigment is useful as a pH indicator. The palygorskite hybrid pigment was mentioned to be potentially useful in the development of an intelligent film that can detect the freshness of food. Lastly, the sepiolite hybrid pigment is useful as a fluorescent hybrid pigment. Based on the information, it was observed that most of the applications of the pigments are connected to the ability of the pigments to change color depending on the pH level, as the recommended applications were based on the mentioned observations.



3. CONCLUSIONS

This paper provides a systematic review of different research on hybrid pigments created with anthocyanins and several clay minerals. Hybrid pigments have been studied due to their environmentally friendly properties from natural pigments combined with the stability from synthetic pigments. Different research papers regarding hybrid pigments made with anthocyanins combined with different mineral clays, particularly saponite, montmorillonite, halloysite, palygorskite, and sepiolite, were discussed and elaborated. A comparison between the processes and interactions has shown that all the cited research utilized adsorption to combine the components, which led to the occurrence of intercalation between the anthocyanin and stabilizer, thus forming the hybrid pigment. It was observed that all the pigments, regardless of stabilizer used, exhibited color-changing properties, wherein the color of the pigment can be manipulated by changing the pH level of the environment. The pigments produced a variety of colors, which included pink, blue, red, brown, yellow, orange, purple, and several more colors. The stability of the pigments has improved, as described through each of the respective research cited, which included improvements in chemical stability, light stability, color stability, and thermal stability. With that in mind, the different possible applications of the hybrid pigments include acidity sensors, colorants, general-use lake pigments, and may also lead to the development of intelligent film capable of detecting the freshness of food. Overall, the paper has shown the development and improvement in hybrid pigment research, particularly with anthocyanin hybrid pigments.

4. ACKNOWLEDGMENTS

The researchers would like to acknowledge the following people: Dr. Francisco Franco, for guiding and helping the researchers as their research adviser; the researchers' parents for their unwavering support; Dr. Ethel Ong and Dr. Ofelia Rempillo for their guidance and support as the researchers' mentors; and the cited researchers who spent their time and effort producing the research used in this paper.

5. REFERENCES

- Britannica, T. Editors of Encyclopaedia (2013). Adsorption. Encyclopædia Britannica. <https://www.britannica.com/science/adsorption>
- Bruni, S., Cicala, N., Freschi, A., Longoni, M. (2019). Non-invasive identification of synthetic organic pigments in contemporary art paints by visible-excited spectrofluorimetry and visible reflectance spectroscopy. *Spectrochimica Acta Part A: Molecular and Biomolecular Spectroscopy*, 11, <https://doi.org/10.1016/j.saa.2019.117907>
- Dufossé, L. (2014). Anthraquinones, the Dr Jekyll and Mr Hyde of the food pigment family. *Food Research International*, 65, 132-136. <https://doi.org/10.1016/j.foodres.2014.09.012>
- Ebrahimi, I., & Parvinzadeh Gashti, M. (2016). Extraction of polyphenolic dyes from henna, pomegranate rind, and *Pterocarya fraxinifolia* for nylon 6 dyeing. *Coloration Technology*, 132(2), 162–176. <https://doi.org/10.1111/cote.12204>
- Kasiri, M. & Safapour, S. (2014). Natural dyes and antimicrobials for green treatment of textiles. *Environmental chemistry letters*, 12(1), 1-13. <https://doi.org/10.1007/s10311-013-0426-2>
- Lagaly, G., Ogawa, M., & Dékány, I. (2013). Clay mineral–organic interactions. In *Developments in Clay Science* (Vol. 5, pp. 435-505). Elsevier. <https://doi.org/10.1016/B978-0-08-098258-8.00015-8>
- Li, S., Ding, J., Mu, B., Wang, X., Kang, Y., & Wang, A. (2019). Acid/base reversible allochroic anthocyanin/palygorskite hybrid pigments: Preparation, stability and potential applications. *Dyes and Pigments*, 171, 107738. <https://doi.org/10.1016/j.dyepig.2019.107738>
- Li, S., Mu, B., Wang, X., Kang, Y., & Wang, A. (2019). A comparative study on color stability of anthocyanin hybrid pigments derived from 1D and 2D clay minerals. *Materials*, 12(20), 3287. <https://doi.org/10.3390/ma12203287>
- Lima, L., Castro-Silva, F., Silva-Filho, E., Fonseca, M., & Jaber, M. (2020a). Saponite-anthocyanin pigments: Slipping between the sheets. *Microporous and Mesoporous Materials*, <https://doi.org/10.1016/j.micromeso.2020.110148>
- Lima, L., Silva, F., Silva-Filho, E., Fonseca, M., Zhuang, G., & Jaber, M. (2020b). Saponite-anthocyanin derivatives: The role of organoclays in pigment photostability. *Applied Clay Science*, 191, <https://doi.org/10.1016/j.clay.2020.105604>
- Ogawa, M., Takee, R., Okabe, Y., & Seki, Y. (2017). Bio-geo hybrid pigment; clay-anthocyanin complex which changes color depending on the atmosphere. *Dyes and Pigments*, 139, 561-565. <https://doi.org/10.1016/j.dyepig.2016.12.054>



- Ribeiro, H. L., de Oliveira, A. V., de Brito, E. S., Ribeiro, P. R., & Azeredo, H. M. (2018). Stabilizing effect of montmorillonite on acerola juice anthocyanins. *Food chemistry*, 245, 966-973. <https://doi.org/10.1016/j.foodchem.2017.11.076>
- Silva, G., da Silva, K., Silva C., Rodrigues, A., Oake, J., Gehlen, M., Bohne, C. & Quina, F.. (2019). Highly fluorescent hybrid pigments from anthocyanin-and red wine pyranoanthocyanin-analogs adsorbed on sepiolite clay. *Photochemical & Photobiological Sciences*, 18(7), 1750-1760. <https://doi.org/10.1039/C9PP00141G>
- Silva, S., Costa, E., Calhau, C., Morais, R. , & Pintado, M. (2017). Anthocyanin extraction from plant tissues: A review. *Critical reviews in food science and nutrition*, 57(14), 3072-3083. <https://doi.org/10.1080/10408398.2015.1087963>
- Singh, S., Gaikwad, K., & Lee, Y. (2018). Anthocyanin-A natural dye for smart food packaging systems. *Korean Journal of Packaging Science & Technology*, 24(3), 167-180. <https://doi.org/10.20909/kopast.2018.24.3.167>



Meta-Analysis on the Dissolution of Bamboo (*Bambusa*) Cellulose using NaOH/urea Aqueous Solution

Jasmin Nicole B. Cristobal, Joachim Xavier B. Po, Raissa Adellaide M. Sison,
and Moira Justine R. Velina
De La Salle University Integrated School, Manila

Dr. Allan N. Soriano
*Chemical Engineering Department, Gokongwei College of Engineering,
De La Salle University, Manila*

Abstract: Bamboo cellulose is a non-dangerous, biodegradable polymer with high elastic, compressive quality thereby beneficial in commercial and pharmaceutical industries. However, preparing it involves a complex procedure of solvent dissolution. NaOH/urea solution is a common solvent for cellulose dissolution, but its efficiency varies with temperature and concentration. Thus, this study aims to synthesize evidence on the efficiency of NaOH/urea solution in bamboo cellulose dissolution; identify the most suitable concentration and temperature of NaOH/urea; and determine the relationships between its concentration, temperature and bamboo cellulose' dissolution rate. Extracted data indicated the bamboo source sample, NaOH/urea concentration, temperature, and dissolution results from five databases and utilized Quality of Reporting of Meta-analyses (QUOROM) and Assessment of Multiple Systematic Reviews (AMSTAR) instruments for the studies' quality assessment. Among the studies, 93% utilized the concentration ratio of 7:12:81; therefore, concentration's minimal changes did not profoundly affect the dissolution, given the same temperatures. Out of fifteen studies, eight used -12°C affirming that minimal changes in temperature affect the dissolution results. The Chi-square test revealed that only temperature and concentration indicate a significant relationship ($\chi^2=5.793$, $P<0.10$). The heterogeneity test displayed a small amount of heterogeneity ($I^2= 33.42\%$, $P<0.10$; $I^2= 1.8\%$, $P<0.10$) on the gathered data that may be clinically unimportant, making the data considerably homogeneous. Hence, this provides significant evidence validating the efficiency of 7:12:81 NaOH/urea aqueous solution at -12°C in the dissolution of bamboo cellulose.

Key Words: bamboo cellulose; bamboo cellulose dissolution; NaOH/urea; meta-analysis; heterogeneity test

1. INTRODUCTION

Bamboos are distinguished by woody and hollow culms, intricate rhizomes and branching processes, narrow leaf blades, and visible sheathing organs. One main component of bamboo is cellulose ($C_6H_{12}O_6$), one of the most universal natural polymers on earth. It is a non-dangerous, biodegradable polymer with high elastic and compressive quality, but it has across the board use in different fields, like the pharmaceutical industry and the construction industry that incorporates cellulose insulation. However, the cellulose must be disintegrated first through solvation to melt it (Gupta et al., 2019).

Preparing bamboo cellulose is difficult and usually takes numerous steps, as there are many solvents to experiment with. Local cellulose must be dissolved in a solvent in order to melt it. Most of the

dissolvable frameworks known have a restricted limit of disintegration that is poisonous and costly, restricting their mechanical capabilities. Another approach in cellulose dissolution shows that cellulose is soluble in aqueous NaOH underneath 268 K inside a particular focus scope of NaOH. This framework is modest, possibly non-contaminating, utilizes extremely regular synthetics, and is moderately simple to deal with (Alves, 2015). Therefore, the focal point of this study is to collect and analyze related studies about the dissolution of bamboo cellulose using NaOH/urea. Specifically, this work determines the most suitable concentration and temperature that can maximize the solubility of bamboo cellulose using NaOH/urea and the relationships between the concentration and temperature of NaOH/urea and the solubility of bamboo cellulose.



2. METHODOLOGY

In identifying the articles that were reviewed in this study, the researchers followed the created criterion while specifying certain “identifiers” from the paper and made use of a checklist set adapted from Porritt et al. (2014) in Table 1. The following set of keywords was used for searching: “Bamboo Cellulose,” “Cellulose Dissolution,” “Bamboo Cellulose Solvation,” “Dissolution of Bamboo Cellulose,” and “NaOH/urea.” The bamboo sample sources were sorted into three categories, namely Bamboo Pulp, Bamboo Pulp Boards, and Pretreated Bamboo.

Table 1. Criteria and identifiers for selection of studies (Porritt et al., 2014)

Criteria	Details	Mark
Date	Any date of the study	✓
Language	Articles in the English, Filipino, or Chinese Language	✓
Peer-review	Only peer-reviewed studies	✓
Setting	Bamboo cellulose solvation done under given temperatures	✓
Methodology	Mixed-method research	✓
Publication	Only articles found in the following databases: Scopus, ScienceDirect, JSTOR, Directory of Open Access Journals (DOAJ), and ResearchGate	✓

This also utilized Quality of Reporting of Meta-analyses (QUOROM) (Russo, 2007) and Assessment of Multiple Systematic Reviews (AMSTAR) (Pizarro et al., 2021) instruments in assessing the quality of the studies from the database search. After the article screening process using Preferred Reporting Items for Systematic Reviews and Meta-Analyses (PRISMA) guidelines (Moher et al., 2009), as displayed in Figure 1, data will be extracted from the studies eligible for inclusion. These extracted data were presented in a tabular format that identified the NaOH/urea concentration, temperature, and dissolution rate from each study. Moreover, statistical analysis increased the reliability of findings through the heterogeneity chi-square test and Higgins’ I² heterogeneity statistic, as these tests are also required in a meta-analysis. After conducting all statistical treatments, these results were used in further analysis in determining the most suitable concentration and temperature for bamboo cellulose’s maximized solubility in NaOH/urea aqueous solution.

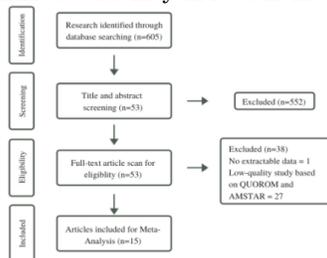

Figure 1. Adapted PRISMA article screening process (Moher et al., 2009)

3. RESULTS AND DISCUSSION

In gathering studies, a total of 605 studies were available from the databases that were searched using the keywords. From these studies, 53 studies chosen based on the title were screened and underwent the identification of studies wherein screening of the abstract and full text was executed. Of these, only 15 studies have met the criteria of quality assessment and were used for data extraction, as shown in the screening process in Figure 1.

Furthermore, the study of Yang et al. (2018) used bamboo pulp boards obtained from Guizhou, China which were dissolved with 7% NaOH/12% urea/81% distilled water at -12 °C. It was found that as soon as cellulose fibers are placed into NaOH/urea aqueous solution, they swell, and part of the intra- and intermolecular hydrogen bonding are destroyed. The work of Chen et al. (2015) used bamboo pulps which were obtained after delignification with sodium chlorite and alkaline treatment with 25% potassium hydroxide from bamboo. It was dissolved in a 7/12 wt % NaOH/urea solution at -12.6 °C. In this study, bamboo pulps just swelled in the NaOH/urea aqueous solution since it had been demonstrated that only cellulose with a viscosity-average molecular weight below 10.0×10^4 Da could be completely dissolved in NaOH/urea aqueous solution. Shi et al. (2017) used commercial bamboo dissolving pulp boards provided by Sichuan Lee & Man., while commercial bamboo dissolving pulp boards provided by Sichuan Liwen Paper Co. Ltd. were also used by Shi et al. (2017). Both were dissolved with 7% NaOH and 12% urea aqueous solution at -13 °C, with a dissolution rate of 43.4.

Additionally, Lin et al. (2017) used bamboo pulp obtained from Sichuan, China, and dissolved it in 7% NaOH, 12% urea, and 81% H₂O solution at -13 °C. After stirring for 10 min, they observed a homogenous cellulose solution. Moreover, bamboo (Phyllostachys heterocyla) pulp from Guizhou Chitanhua Paper Industry Co., Ltd. was used by Zhu et al. (2015), which was dissolved at 7% NaOH and 12% urea, precooled to 4 °C and maintained at -12 °C. It had a dissolution rate of 100% with a transparent and viscous bamboo pulp cellulose solution. Similar results were observed by Nguyen et al. (2019) where they used micron-size White Bamboo (*Dendrocalamus membranaceus* Munro) fibrils, a pretreated bamboo from Hoa Binh Province, Vietnam, which was dissolved in 7% NaOH, 12% urea, and 81% distilled water at 5°C. Their results show almost 24% dissolution with a semi-transparent to transparent cellulose. In the study of Tang et al. (2017), cellulose was obtained from a bamboo dissolving pulp board from Sichuan, China, where it was dissolved in NaOH/urea/water solution (7:12:81 by weight) at -12°C. In the cellulose I crystals, the hydrogen bonds were destroyed when the cellulose I crystals were dissolved in NaOH/urea solution.



Moreover, Li et al. (2011) also used pretreated bamboo, but with partially delignified bamboo (*Neosinocalamus affinis*) culms which were 100% dissolved with 7% sodium hydroxide/12% urea solution at -12 °C. Figure 2 summarizes the dissolution rate of the aforementioned individual studies while Table 2 summarizes the data extracted from these studies.

Out of the 15 studies, 14 studies (93%) utilized the 7:12:81 ratio for the concentration of NaOH/urea aqueous solution (see Figure 3). Almost all of these studies showed the said concentration to be 100% effective for bamboo cellulose dissolution. Varying dissolution rate may have resulted from other factors like vigorous stirring (Nguyen et al., 2019), ultrasound/ethanol pretreatment (Li et al., 2021), and vacuum oven drying (Shi et al., 2017 & Shi et al., 2017); yet, they are still proven to be effective. However, the study of Ma et al. (2017) used the concentration ratio of 7.5:11:81.5. The minimal change in the concentration did not greatly affect the dissolution of bamboo cellulose, given that the temperature is the same. For these reasons, the optimum NaOH-urea-distilled water ratio for dissolving bamboo cellulose is 7:12:81.

Table 2. Summary of the data extracted

Bamboo Source Sample	NaOH-urea-distilled water Concentration	Temperature	Dissolution Rate	Author/s	Year
Bamboo Pulp	7:12:81	-12.5 °C	100%	Li et al.	2015
Bamboo Pulp	7.5:11:81.5	-7 °C	100%	Zhai et al.	2018
Pretreated Bamboo	7:12:81	-12 °C	61%	Kong et al.	2021
Bamboo Pulp	7:12:81	-12 °C	75.1 - 77.7%	Li et al.	2010
Bamboo Pulp	7:12:81	-12 °C	83.6% - 86.6%	Li et al.	2021
Bamboo Pulp Boards	7:12:81	-12 °C	61%	Yang et al.	2018
Bamboo Pulp	7:12:81	-12.6 °C	0%	Chen et al.	2015
Bamboo Pulp Boards	7:12:81	-13 °C	43.4%	Shi et al.	2017
Bamboo Pulp Boards	7:12:81	-13 °C	43.4%	Shi et al.	2017
Bamboo Pulp	7:12:81	-13 °C	100%	Lin et al.	2017
Bamboo pulp	7:12:81	-12 °C	100%	Zhu et al.	2015
Pretreated Bamboo	7:12:81	5 °C	24%	Nguyen et al.	2019
Pretreated Bamboo	7:12:81	-12 °C	100%	Lou et al.	2015
Bamboo Pulp Board	7:12:81	-12 °C	100%	Tang et al.	2017
Pretreated Bamboo	7:12:81	-12°C	100%	Li et al.	2011
Bamboo pulp	7:12:81	-12 °C	100%	Zhu et al.	2015
Pretreated Bamboo	7:12:81	5 °C	24%	Nguyen et al.	2019
Pretreated Bamboo	7:12:81	-12 °C	100%	Lou et al.	2015
Bamboo Pulp Board	7:12:81	-12 °C	100%	Tang et al.	2017
Pretreated Bamboo	7:12:81	-12°C	100%	Li et al.	2011

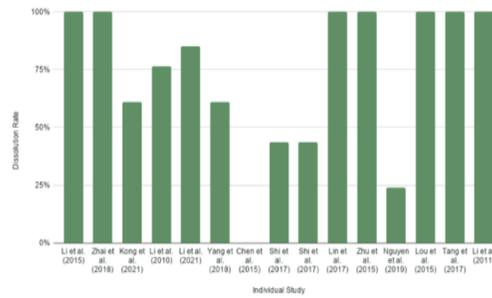

Figure 2. Pooled dissolution percentages of individual studies

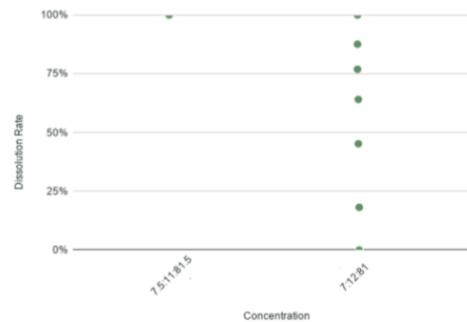

Figure 3. Effect of concentration of the solution on dissolution rate of bamboo cellulose

Meanwhile, 8 out of 15 studies dissolved bamboo cellulose at a relatively lower temperature, specifically at -12°C. Nearly all of the studies show that bamboo cellulose can be 100% dissolved using NaOH/urea at -12°C, as shown in Figure 4. Results obtained by Li. et al. (2011) and Zhu et al. (2015) present that the most effective and efficient way to completely dissolve pretreated bamboo and bamboo pulp was at -12°C. On the other hand, Nguyen et al. (2019) and Chen et al. (2015) dissolved cellulose at 5°C and -12.6°C. Minimal change in the temperature affected the dissolution results since at -12.6°C, the bamboo pulp just swelled in the NaOH/urea aqueous solution, and 0% of the pulp was dissolved. Moreover, Zhai et al. (2018) argued against the application of temperature above 0°C in the solution as cellulose would not be dissolved in that case as the swelling, softening, and dissolving exothermic processes can only protect the pulp fibers at low temperatures below that degree. Under these conditions, the most ideal temperature for the solvation of bamboo cellulose is at -12°C.

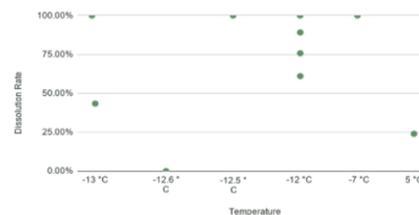

Figure 4. Effect of solution's temperature on dissolution rate of bamboo cellulose



To solidify the findings, statistical analyses were done. Chi-square test was used to confirm if there were significant relationships between variables. Upon analysis, bamboo sample sources and temperature of the aqueous solution ($\chi^2=3.945$, $P<0.10$) were independent of each other. Concentration of aqueous solution and bamboo sample sources ($\chi^2=1.587$, $P<0.10$) also have no significant relationship. Conversely, temperature and concentration ($\chi^2=5.793$, $P<0.10$) of the aqueous solution indicates relation. Furthermore, determining statistical heterogeneity is important for a meta-analysis to detect variability among factors influencing the intervention. In this analysis, a p -value of 0.10 was used to determine statistical significance as nonsignificant results were not considered evidence for heterogeneity. The Higgins' I^2 test revealed a small amount of heterogeneity on the gathered data that may be clinically unimportant, thereby making the data considerably homogeneous: ($I^2= 33.42\%$, $P<0.10$ for source and temperature; $I^2= 1.8\%$, $P<0.10$ for source and concentration). Visual assessment of the plotted rates in Figure 4 showed that four studies (Lin et al., 2017; Shi et al., 2017; Chen et al., 2015; Nguyen et al., 2019) accounted for the heterogeneity with extreme temperatures as the possible reason ($I^2= 69.52\%$, $P<0.10$). Hence, the substantial evidence corroborates the guaranteed efficiency of NaOH/urea aqueous solution at low temperature in the dissolution of bamboo cellulose.

4. CONCLUSIONS

Accounting for 93% of all studies, the 7:12:81 ratio for the concentration of NaOH/urea aqueous solution dominated the data and mostly exhibited a 100% efficiency for the dissolution of bamboo cellulose. Therefore, the optimum NaOH-urea-distilled water ratio for dissolving bamboo cellulose is 7:12:81. Meanwhile, 8 out of 15 studies dissolved bamboo cellulose at a relatively lower temperature, specifically at $-12\text{ }^\circ\text{C}$. Minimal change in the temperature affected the dissolution results with temperatures exceeding $0\text{ }^\circ\text{C}$ labeled as protection-inefficient and receding $-12\text{ }^\circ\text{C}$ resulted in swelling; thus, the most ideal temperature for the solvation of bamboo cellulose is at $-12\text{ }^\circ\text{C}$. The Chi-square test showed that both the relationship of bamboo sample sources and temperature of the aqueous solution and the relationship of concentration of aqueous solution and bamboo sample sources have no significant relationship. Meanwhile, temperature and concentration indicate relation. The test for heterogeneity displayed a small amount of heterogeneity on the gathered data that may be clinically unimportant thereby making the data considerably homogeneous. The heterogeneity of the data ($I^2= 69.52\%$, $P<0.10$) was mainly affected by the

extreme temperatures used by the individual studies. Overall, the significant evidence validates the efficiency of NaOH/urea aqueous solution at low temperature in the dissolution of bamboo cellulose.

5. ACKNOWLEDGMENTS

Before all else, praises to De La Salle University - Senior High School for providing us an avenue to explore our passions and enabling us to unlock our innate research talents. We would like to thank our families for their undying support and guidance in our everyday life, especially in the making of this research project. They have provided us with everything we need in preparation for this study: funding, patience, and understanding. To our friends who were always there when we needed help, thank you for being the shoulders we could lean on. We are sincerely grateful for all the help you all have given to us, may it be academically and mentally wise.

Above all, the researchers share their deepest gratitude to their Research Adviser, Dr. Allan Soriano, for guiding and supervising them. It was a privilege to work under his wing, and the researchers are grateful for what he has offered them. The researchers' completion of this study could not have been successful without his support. It is with no doubt the researchers believe the lifelong learnings he has instilled will carry on beyond research consultations.

6. REFERENCES

- Alves, L. H. (2015). Cellulose solutions: dissolution, regeneration, solution structure and molecular interactions. Coimbra, Portugal: Universidad de Coimbra. DOI: 10.5772/61402
- Chen, J., Guan, Y., Wang, K., Zhang, X., Xu, F., & Sun, R. (2015). Combined effects of raw materials and solvent systems on the preparation and properties of regenerated cellulose fibers. *Carbohydrate Polymers*, 1(128), 147–153. <https://doi.org/10.1016/j.carbpol.2015.04.027>
- Gupta, P., Raghunath, S., Prasanna, D., Venkat, P., Shree, V., Chithananthan, C., . . . Geetha, K. (2019, May 13). An update on overview of cellulose, its structure and applications. In A. Pascual & M. Martín (Eds) *Cellulose*. IntechOpen. DOI: 10.5772/intechopen.84727
- Kong, W., Yu, G., Xing, J., Kong, R., Liu, M., & Shi, Y. (2021). Effect of the Dissolving Method on the Dissolution of Dissolving Pulp Cellulose Fibers with Different Dried-States in Different NaOH/additives Aqueous Solutions DOI: 10.21203/rs.3.rs-167392/v1
- Li, M-F., Fan, Y-M., Xu, F., & Sun, R-C. (2011). Structure and thermal stability of polysaccharide fractions extracted from the ultrasonic irradiated



- and cold alkali pretreated bamboo. *Journal of Applied Polymer Science*.
<https://doi.org/10.1002/app.33491>
- Li, M.-F., Fan, Y.-M., Xu, F., Sun, R.-C., & Zhang, X.-L. (2010). Cold sodium hydroxide/urea-based pretreatment of bamboo for bioethanol production: Characterization of the cellulose rich fraction. *Industrial Crops and Products*, 32(3), 551–559.
<https://doi.org/10.1016/j.indcrop.2010.07.004>
- Li, M.-F., Yong-Ming Fan, Feng Xu, & Sun, R.-C. (2021). Characterization of Extracted Lignin of Bamboo (*Neosinocalamus Affinis*) Pretreated with Sodium Hydroxide/Urea Solution at Low Temperature. *BioResources*, 5(3), 1762–1778.
https://ojs.cnr.ncsu.edu/index.php/BioRes/article/view/BioRes_05_3_1762-1788_Char_Extracted_Lignin_Bamboo
- Li, R., Wang, S., Lu, A., & Zhang, L. (2015). Dissolution of cellulose from different sources in an NaOH/urea aqueous system at low temperature. *Cellulose*, 22(1), 339–349. DOI:10.1007/s10570-014-0542-6
- Lin, X., Ma, W., Wu, H., Huang, L., Chen, L., & Takahara, A. (2017). Fabrication of cellulose based superhydrophobic microspheres for the production of magnetically actuatable smart liquid marbles. *Journal of Bioresources and Bioproducts*, 2(3), 110-115. DOI: 10.21967/jbb.v2i3.132
- Lou, H., Zhu, D., Yuan, L., Lin, H., Lin, X., & Qiu, X. (2015). Fabrication and property of low crystallinity nanofibrillar cellulose and nanofibrillar cellulose graphene oxide composite. *The Royal Society of Chemistry*, 5(83), 67568-67573. <https://doi.org/10.1039/C5RA13181B>
- Moher, D., Liberati, A., Tetzlaff, J., Altman, D.G., The PRISMA Group (2009). Preferred Reporting Items for Systematic Reviews and Meta-Analyses: The PRISMA Statement. *Open Med* 2009, 3(3), 123-130.
<http://dx.doi.org/10.1016/j.ijssu.2010.02.007>
- Nguyen, D. D., Vu, C. M., Vu, H. T., & Choi, H. J. (2019). Micron-Size White Bamboo Fibril-Based Silane Cellulose Aerogel: Fabrication and Oil Absorbent Characteristics. *Materials*, 12(9), 1407.
<https://doi.org/10.3390/ma12091407>
- Pizarro, A.B., Carvajal, S., Buitrago-López, A. (2021). Assessing the methodological quality of systematic reviews using the AMSTAR tool. *Colombian Journal of Anesthesiology*. 49(1), 913.
: <https://doi.org/10.5554/22562087.e913>
- Porritt, K., Gomersall, J., & Lockwood, C. (2014). JBI's Systematic Reviews: Study selection and critical appraisal. *AJN, American Journal of Nursing*, 114(6), 47–52.
<https://doi.org/10.1097/01.naj.0000450430.97383.64>
- Russo M. W. (2007). How to Review a Meta-analysis. *Gastroenterology & hepatology*, 3(8), 637–642.
<https://www.ncbi.nlm.nih.gov/pmc/articles/PMC3099299/#:~:text=Meta%2Danalysis%20is%20a%20systematic,a%20treatment%20intervention%20or%20exposure.>
- Shi, Y., Zhang, K., Sun, H., Zhu, Y., Hu, Z., Zheng, Q., & Yang, F. (2017). Dissolution behavior of higher DP bamboo dissolving pulp fiber in NaOH/additive aqueous solution. *Functional Materials*, 48(6), 6080-6085.
<https://doi.org/10.3969/j.issn.1001-9731.2017.06.014>
- Shi, Y., Zhang, K., Ya-tong, Z., Zhen-xing, H., Nan, S., Miao-li, B., & Lin, P. (2017). The Influence of Alkali Pretreatment on the Dissolution of Bamboo Dissolving Pulp in NaOH/Urea System. *Chinese Journal of Paper Industry*, 32(2), 12–16. *Transactions of China Pulp and Paper*.
<https://doi.org/10.11981/j.issn.1000-6842.2017.02.12>
- Tang, Z., Li, W., Lin, X., Xiao, H., Miao, Q., Huang, L., Chen, L., & Wu, H. (2017). TEMPO-Oxidized Cellulose with High Degree of Oxidation. *Polymers*, 9(12), 421.
<https://doi.org/10.3390/polym9090421>
- Yang, X., Fei, B., Ma, J., Liu, X., Yang, S., Tian, G., & Jiang, Z. (2018). Porous nanoplatelets wrapped carbon aerogels by pyrolysis of regenerated bamboo cellulose aerogels as supercapacitor electrode. *Carbohydrate Polymers*, 180, 385–392.
<https://doi.org/10.1016/j.carbpol.2017.10.013>
- Zhai, R., Ma, J., Hu, Z., & Hou, J. (2018). The Effects of NaOH-Urea Aqueous Solution on the Strength and Softness Properties of Bamboo Lignocellulosic Fibers. *BioResources*, 13(1), 1088-1106.
<https://doi.org/10.15376/biores.13.1.1088-1106>
- Zhu, H., Zhang, Y., Yang, X., Liu, H., Zhang, X., & Yao, J. (2015). An Eco-friendly One-Step Synthesis of Dicarboxyl Cellulose for Potential Application in Flocculation. *Industrial & Engineering Chemistry Research*, 54(10), 2825–2829.
<https://doi.org/10.1021/ie503020n>



Development of Generalized Correlation for Electrical Conductivity Prediction of Pure Ionic Liquid

Carlos Gabriel A. Arguelles, Carlos John B. Dionio,
John Matthew C. Enciso, Ar Jetterson T. Go, and Paul Andrei M. Jardiolin
De La Salle University Integrated School, Manila

Dr. Allan N. Soriano
*Chemical Engineering Department, Gokongwei College of Engineering,
De La Salle University, Manila*

Abstract: Ionic liquids are salts in liquid form that are composed of short-lived ion pairs. They are the new trend of solvent because of their very low vapor pressure, good chemical and thermal stability, and melting temperatures lower than 100°C. Pure ionic liquids contain ions that can conduct electricity or serve as electrolytes. But experimentation using ionic liquids would be expensive. This study aims to develop a generalized correlation for the electrical conductivity prediction of pure ionic liquids. The researchers gathered data of pure ionic liquids that involved the electrical conductivity property from the ThermoIL Database. The collected data were then trimmed based on a developed scheme and classifications. After trimming the data, the researchers evaluated the data using MATLAB software. The residual value was calculated, and a parity plot was constructed to test the models' accuracy. The researchers gathered 2,425 data points from 310 references and were trimmed to 220 data points from 21 references. The parity plot and graph of the residuals plotted against pressure showed that the experimental and calculated values were close. Results showed that the electrical conductivity of pure ionic liquids could be predicted using a model patterned to Pitzer correlation with reduced temperature and reduced pressure as variables. Data with two or more references and low uncertainty made a good result on the models to create a generalized correlation via curve fitting.

Key Words: pure ionic liquids; electrical conductivity; generalized correlation; data trimming; data mining

1. INTRODUCTION

Ionic liquids (ILs) are liquid salts that are composed of ions and short-lived ion pairs. ILs are potential substitutes for dangerous solvents for preparing solutions such as gels, composites, and polymeric belts (Shakeel et al., 2019). Some of the interesting properties of ILs include Chemical and thermal stability, very low vapor pressures, and melting temperatures below 100°C. In 1914, Paul Walden was the first to find ILs. Walden was looking for liquid molten salts at a specific temperature to use in his equipment without fulfilling any specifications. The melting point of ethylammonium nitrate (EtNH₃NO₃), the first IL found, is 12°C, according to Walden (Welton, 2018). ILs are also environmentally friendly, easily recyclable, highly efficient, and similarly structured to conventional solvents. As a result, these liquids have become the latest solvent standard.

The electrical conductivity of ILs is also an intriguing property. Electrical conductivity (σ), also

known as conductance, is the potential of a material to bear an electric current (Helmenstine, 2020). Based on the temperature, each liquid material has a different conductance. Electrical conductivity increases by two to three percent with every one-degree Celsius increase in temperature. Between liquid substances, pure water has the lowest conductivity. That is primarily due to the low number of ions present in pure water. ILs, in contrast, have many ions that are essential in conductance. An aqueous substance's conductivity increases as the number of ions present increases, indicating a solid electrolyte. Thus, ILs are used in commercial devices as an electrolyte with longer battery life because of their low vapor pressure.

Conducting experiments or research utilizing ionic liquids would be expensive. One of the cheapest IL in the market is the Trihexyltetradecylphosphonium bis(2,4,4-trimethylpentyl) phosphinate, which costs \$21 (approximately Php 1066.50) for five grams. This is

the main reason why most researchers do data mining rather than doing experiments. Data collected by experimental procedures of previous researchers are collected and compiled on a database accessed on the internet. These data, however, are not being utilized well. Data mining is the process of discovering correlations, patterns, and trends using pattern recognition technologies and statistical and mathematical techniques (Gartner Group, 2014). This process is an efficient way to utilize available data on the internet. There are different data mining methods, and each has different uses depending on the situation, which can help businesses and researchers (Loginworks Software, 2014).

This research aims to develop a generalized correlation for the prediction of the electrical conductivity of pure ionic liquids. It also seeks to determine the most suitable data available from literature (ThermoIL Database) using the data trimming process and create the generalized correlation via-curve fitting the data using the MATLAB Software. This study, on the other hand, will help other researchers develop their research, especially those who have similar topics to this study. Furthermore, manufacturers can also innovate new products and find an ionic liquid that can serve as an electrolyte and improve its quality using this mathematical model.

This study solely aims to create a correlational model that can help predict the electrical conductivity of pure ILs. It does not cover the uses of knowing the electrical conductivity of ILs; it will only serve as a stepping stone to other researchers that plan to create commercial applications from pure ILs. This study will also gather data from the ThermoIL database only. The researchers will be cross-referencing, and they will use the data to create a correlational model for predicting pure IL's electrical conductivity. The study will not perform any laboratory experiments to justify the claims. The study will not include binary mixtures and tertiary mixtures, and ILs that do not have standard pressure.

2. METHODOLOGY

2.1 Collection of Data from ThermoIL database

The researchers first collected data. These data were collected from the ThermoIL database, covered pure ionic liquids, and focused on an ionic liquid's electrical conductivity property. The researchers also gathered the chemical structures for each of the chemical formulas for its visual representation. Each IL was given codes according to their cation and anion. The researchers obtained the International Union of Pure and Applied Chemistry

(IUPAC) name of the pure IL, molar weight in terms of grams per mole (g/mol), pressure in terms of kilopascal (kPa), the temperature range in terms of Kelvin (K), electrical conductivity range in terms of siemens per meter (S/m), and its reference.

2.2 Data Trimming

The researchers gathered data of pure ILs reporting electrical conductivity from all available literature in the ThermoIL database. All of the data gathered from experimental procedures have been assessed carefully to ensure only accurate and reliable data will be collected and used since this research will only conduct computational methods. Figure 1 shows a developed scheme for the data trimming process and was classified into three categories as follows; (i) systems with more than two available references, (ii) systems with two available references, and (iii) systems with only one reference. Different data trimming procedures were done in each category. The data from the systems with more than two references had been trimmed by only using the most consistent data with the other references. For systems with two references, the most accurate between them was chosen based on the uncertainty reported. Systems with only one reference had been considered automatically; however, systems that only have two or fewer data points were removed and were not considered. Trimmed data were then investigated to gather the cations and anions (Soriano, Agapito, Lagumbay, Caparanga & Li, 2010).

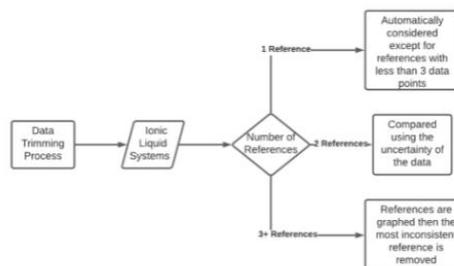

Figure 1. Data trimming flowchart

2.3 Development of Generalized Correlation for Electrical Conductivity

The researchers created a mathematical model. It was used to predict the electrical conductivity of a pure ionic liquid. The model used is patterned to the general Pitzer correlation to fit electrical conductivity, σ , as a function of temperature, T. It is represented as:

$\sigma = T^{\omega_0} + T^{\omega_1}$ (Eq. 1) where ω is the acentric factor for the ionic liquid. For this study, the parameters T0 and T1

were defined as quadratic functions of the temperature:

$$T_0 = A_1 + A_2 T T_c + A_3 T T_c^2 \quad (\text{Eq. 2})$$

$$T_1 = A_4 + A_5 T T_c + A_6 T T_c^2 \quad (\text{Eq. 3})$$

The ratio of T and T_c is the reduced temperature, where T_c is the critical temperature of the ionic liquid. Empirical constants were represented as A_n ($n = 1$ to 6), and acentric factors and critical data were obtained from the paper of Valderrama, Forero, and Rojas (2012). Pitzer's equations are used to describe the activity coefficients of aqueous electrolytes.

2.4 Testing of Model

The researchers tested the model's accuracy by finding the distance between the experimental (literature) data and calculated (predicted) data. It was determined using the Residual as follows:

$$\text{Residual} = y - \hat{y}$$

(Eq. 4) where y is the experimental electrical conductivity and \hat{y} is the calculated electrical conductivity.

The researchers also created a parity plot, a plot used to compare experimental or literature values to the calculated or tabulated values. Its purpose is to determine whether the obtained values are acceptable or not.

3. RESULTS AND DISCUSSION

The researchers were able to collect the data needed in this research from the ThermoLL database. They have collected 2,425 data points from 310 reference studies, which observed the criteria required. The gathered electrical conductivity of pure ILs from the database were all under standard pressure and are in the liquid phase.

The data collected underwent a data trimming process to remove unnecessary and insignificant data. ILs were grouped for data trimming according to the number of references available. References with less than three data points were first removed from all the groups of ILs. The data with only one reference was retained, while for those with two references, the data with high uncertainty were removed. The data with more than two references were plotted in a graph. The data that do not fit the dataset was then removed. Figure 2 shows an example of a graph used in the data trimming process for ILs with more than two references. The reference that contains the yellow points was removed from the dataset.

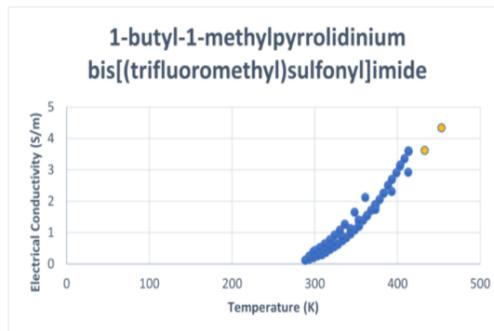

Figure 2. Example of data trimming for ILs with more than two references

The data trimming process reduced the number of data points and references to 2,231 and 203, respectively. Due to data unavailability, the numbers were cut off again after the researchers gathered the acentric factors and critical constants needed for the process. ILs with incomplete factors and constants were removed, decreasing the number of data points and references to 220 and 21, respectively. Table 1 shows the summary of the trimmed data used to develop the generalized correlation.

In using MATLAB software, equations 2 and 3 were manipulated to reduce the deviation of the experimental data and calculated data. Equations 5 and 6 show the new equations used in the process with the addition of pressure and critical pressure values. Figure 3 shows the parity plot that displays the relationship between the experimental and calculated data. It shows that most of the data points are near the line of equality, indicating that most of the calculations are close to experimental values.

$$T^0 = A_1 + A_2 \left(\frac{T}{T_c}\right) + A_3 \left(\frac{T}{T_c}\right)^2 + A_4 \left(\frac{P}{P_c}\right) + A_5 \left(\frac{P}{P_c}\right)^2 \quad (\text{Eq. 5})$$

$$T^1 = A_6 + A_7 \left(\frac{T}{T_c}\right) + A_8 \left(\frac{T}{T_c}\right)^2 + A_9 \left(\frac{P}{P_c}\right) + A_{10} \left(\frac{P}{P_c}\right)^2 \quad (\text{Eq. 6})$$

Table 1. Summary of the trimmed data used in the development of the generalized correlation

IUPAC Name	MW	Acentric Factor	Critical Temp.	Critical Pressure	Pressure	Temp. Range	Electrical Conductivity Range	Data Points	Reference
1-[2-hydroxyethyl]-3-methylimidazolium bis[(trifluoromethyl)sulfonyl]imide	407.3	0.5172	1297.5	3307	101.325	283.15 - 353.15	0.1315 - 1.815	15	Liu et al. (2015)
1,2-dimethyl-3-propylimidazolium bis[(trifluoromethyl)sulfonyl]imide	419.36	0.32	1269.7	2746	100	293.15-323.15	0.196 - 0.687	7	Papovic et al. (2016)
1-butyl-3-methylimidazolium tetrafluoroborate	226.03	0.8877	443.2	2038	101.325	303 - 353	0.416 - 2.144	11	Iwasaki et al. (2017)



1-butyl-3-methylimidazolium tetrafluoroborate	226.03	0.8877	643.2	2038	101.325	298.15-333.15	0.36 - 1.516	8	Pandit et al. (2016)
1-butyl-3-methylimidazolium thiocyanate	197.30	0.4781	1047.4	1938	101.325	298.15-333.15	0.644 - 1.862	8	Pandit et al. (2016)
1-butyl-3-methylimidazolium tris(trimethylsilyl)phosphonium hexafluorophosphate	229.29	0.9266	1185.1	2114	101.325	295.25 - 379.25	1.027 - 4.56	11	Zubei et al. (2015)
1-butylpyridinium bis(trifluoromethylsulfonyl)imide	416.35	0.2505	1229.1	2771	101.325	299-344	0.191 - 0.937	6	Dzida et al. (2019)
1-butylpyridinium bis(trifluoromethylsulfonyl)imide	416.35	0.2505	1229.1	2771	101.325	278.15 - 438.15	0.1186 - 5.243	15	Nazet et al. (2017)
1-ethyl-2,3-dimethylimidazolium bis(trifluoromethylsulfonyl)imide	405.33	0.2794	1258.9	2975	100	293.15-323.15	0.309 - 0.92	7	Papovic et al. (2016)
1-ethyl-3-methylimidazolium acetate	170.21	0.5889	807.1	2919	101	288.15 - 353.15	0.151 - 2.223	14	Zhang et al. (2017)

1-ethyl-3-methylimidazolium acetate	170.21	0.5889	807.1	2919	101	298.15 - 418.15	0.2776 - 6.917	13	Nazet et al. (2015)
1-ethyl-3-methylimidazolium acetate	170.21	0.5889	807.1	2919	101	298.15 - 323.15	0.2875 - 0.918	6	Oliveira et al. (2015)
1-ethyl-3-methylimidazolium methanesulfonate	206.26	0.3307	1026	4813	101.325	273.15 - 353.15	0.04134 - 1.994	19	Harris et al. (2016)
1-ethyl-3-methylimidazolium trifluoromethanesulfonate	260.23	0.3255	992.30	3584	101.325	273.15 - 353.15	0.346 - 3.287	13	Harris et al. (2016)
1-ethyl-3-methylimidazolium trifluoromethanesulfonate	260.23	0.3255	992.30	3584	101.325	297.65 - 304.65	0.81 - 1.14	5	Aranowski et al. (2016)
1-ethyl-3-methylimidazolium trifluoromethanesulfonate	260.23	0.3255	992.30	3584	101	288.15 - 333.15	0.605 - 2.236	3	Asenbauer et al. (2017)

1-ethylpyridinium bis(trifluoromethylsulfonyl)imide	388.3	0.167	1207.9	3275	101.325	303-343	0.528 - 1.335	5	Dzida et al. (2019)
1-octyl-3-methylimidazolium bis(trifluoromethylsulfonyl)imide	475.47	0.4811	1317.8	2098	101	273.15 - 468.15	0.0308 - 4.029	29	Nazet et al. (2015)
1-octyl-3-methylimidazolium bis(trifluoromethylsulfonyl)imide	475.47	0.4811	1317.8	2098	100	293.15 - 323.15	0.106 - 0.361	7	Papovic et al. (2016)
butylammonium formate	119.16	0.5182	521.1	3466	100	293.15 - 333.15	0.287 - 0.873	9	Wei et al. (2018)
propylammonium formate	105.14	0.4839	496.6	3919	101.325	293.15 - 333.15	0.31 - 1	9	Chhotaray et al. (2015)

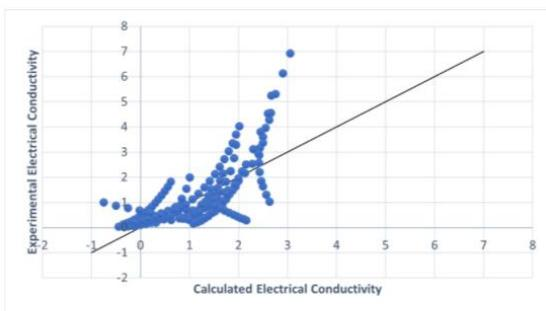

Figure 3. Parity plot

The residual, on the other hand, is shown in figures 4 and 5, plotted against the reduced pressure (Pr) and reduced temperature (Tr), respectively. Both figures show the patterned mathematical model is appropriate for the dataset. In addition, the plot shows that the residuals are not far from zero, indicating that the calculated electrical conductivity is close to the experimental electrical conductivity. It also shows that the model has both underprediction and overprediction of the data.

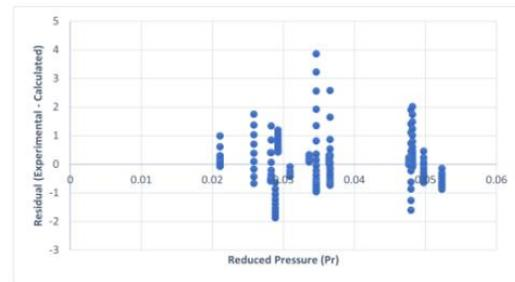

Figure 4. Residual plotted against reduced pressure

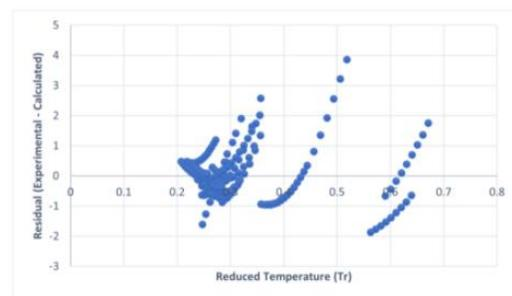

Figure 5. Residual plotted against reduced temperature

According to Van der Waals' Corresponding States Principle, substances behave alike at the same reduced states. Figure 6 shows the relationship between reduced pressure and the experimental data. Different colored lines connect the substances with the same reduced temperature. The graph for each reduced temperature follows the same pattern. However, as the reduced temperature decreases, the graph will have an inconsistent pattern compared to the graphs in Figure 6 and more complicated as shown on the graph of $Tr = 0.26$.

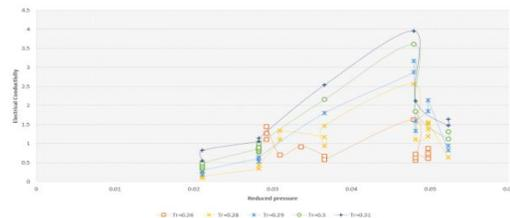

Figure 6. Reduced pressure plotted against electrical conductivity



4. CONCLUSIONS

The researchers have successfully created a model that can predict the electrical conductivity of pure ionic liquids. Using data trimming, the researchers have identified the most suitable data to be used in the study. Still, the unavailability of constants needed for the process significantly affected the number of the data point used in the study. Most of the calculated data from the model are close to their respective experimental values. However, there are some systems that the researchers have underestimated. Thus, further research should be conducted to have a more accurate prediction of the property. The model produced by this study can be used as a reference model for future studies that will be conducted. Manufacturers that would use this model as a basis for their research and innovation of their products should note some Ionic Liquid system that has been underestimated to be avoided since it is not accurate enough compared to other systems.

5. ACKNOWLEDGMENTS

The researchers would like to express their deepest gratitude to their marvelous adviser, Dr. Allan N. Soriano, for his guidance in accomplishing this research. His consideration and patience with his research mentees were greatly appreciated.

6. REFERENCES

- Aranowski, R., Cichowska-Kopczyńska, I., Dębski, B., & Jasiński, P. (2016). Conductivity and viscosity changes of imidazolium ionic liquids induced by H₂O and CO₂. *Journal of Molecular Liquids*, 221, 541-546.
- Asenbauer, J., Hassen, N. B., McCloskey, B. D., & Prausnitz, J. M. (2017). Solubilities and ionic conductivities of ionic liquids containing lithium salts. *Electrochimica Acta*, 247, 1038-1043.
- Chhotaray, P. K., & Gardas, R. L. (2015). Structural dependence of protic ionic liquids on surface, optical, and transport properties. *Journal of Chemical & Engineering Data*, 60(6), 1868-1877.
- Dzida, M., Musiał, M., Zorębski, E., Zorębski, M., Jacquemin, J., Goodrich, P., ... & Paluch, M. (2019). Comparative study of effect of alkyl chain length on thermophysical characteristics of five N-alkylpyridinium bis(trifluoromethylsulfonyl)imides with selected imidazolium-based ionic liquids. *Journal of Molecular Liquids*, 278, 401-412.
- Gartner Group. (2014). Data mining. Retrieved from <https://www.gartner.com/en/information-technology/glossary/data-mining#:~:text=Data%20mining%20is%20the%20process,as%20statistical%20and%20mathematical%20techniques>.
- Ghasemian, E., Zobeydi, R. (2013). Ionic liquids surface tension prediction based on enthalpy of vaporization. Retrieved from https://www.sciencedirect.com/dlsu.idm.oclc.org/science/article/pii/S0378381213004354?via%3Dihub&fbclid=IwAR3OIJALZGBZCyW4rkQnIuDduvQAzV0TvHK_NnSAImvPgGpvcvu9eTyw7Ec
- Harris, K. R., & Kanakubo, M. (2016). Self-diffusion coefficients and related transport properties for a number of fragile ionic liquids. *Journal of Chemical & Engineering Data*, 61(7), 2399-2411.
- Helmenstine, A. (2020). Understand electrical conductivity. Retrieved from <https://www.thoughtco.com/definition-of-electrical-conductivity-605064>
- Iwasaki, K., Yoshii, K., Tsuda, T., & Kuwabata, S. (2017). Physicochemical properties of phenyl trifluoroborate-based room temperature ionic liquids. *Journal of Molecular Liquids*, 246, 236-243.
- Liu, Q. S., Liu, J., Liu, X. X., & Zhang, S. T. (2015). Density, dynamic viscosity, and electrical conductivity of two hydrophobic functionalized ionic liquids. *The Journal of Chemical Thermodynamics*, 90, 39-45.
- Loginworks Softwares. (2014). Data mining and its importance. Retrieved from <https://www.loginworks.com/blogs/217-data-mining-and-its-importance/>
- Nazet, A., Sokolov, S., Sonnleitner, T., Friesen, S., & Buchner, R. (2017). Densities, refractive indices, viscosities, and conductivities of non-imidazolium ionic liquids [Et3S][TFSI], [Et2MeS][TFSI], [BuPy][TFSI], [N8881][TFA], and [P14][DCA]. *Journal of Chemical & Engineering Data*, 62(9), 2549-2561.
- Nazet, A., Sokolov, S., Sonnleitner, T., Makino, T., Kanakubo, M., & Buchner, R. (2015). Densities, viscosities, and conductivities of the imidazolium ionic liquids



- [Emim][Ac],[Emim][FAP],[Bmim][BETI],[Bmim][FSI],[Hmim][TFPI], and [Omim][TFPI].
Journal of Chemical & Engineering Data, 60(8), 2400-2411.
- Nazet, A., Weiß, L., & Buchner, R. (2017). Dielectric relaxation of nitromethane and its mixtures with ethylammonium nitrate: Evidence for strong ion association induced by hydrogen bonding. *Journal of Molecular Liquids*, 228, 81-90.
- Oliveira, F. S., Rebelo, L. P., & Marrucho, I. M. (2015). Influence of different inorganic salts on the ionicity and thermophysical properties of 1-ethyl-3-methylimidazolium acetate ionic liquid. *Journal of Chemical & Engineering Data*, 60(3), 781-789.
- Papović, S., Gadžurić, S., Bešter-Rogač, M., & Vraneš, M. (2016). Effect of the alkyl chain length on the electrical conductivity of six (imidazolium-based ionic liquids+ γ -butyrolactone) binary mixtures. *The Journal of Chemical Thermodynamics*, 102, 367-377.
- Sattari, M., Kamari, A., Mohammadi, A., Ramjugernath, D. (2016). On the prediction of critical temperatures of ionic liquids: Model development and evaluation. Retrieved from https://www.sciencedirect.com/dlsu.idm.oclc.org/science/article/pii/S0378381215302302?via%3Dihub&fbclid=IwAR19SbM443XduRS3Xt_kkwm2YINsmtZJJL_gwmVzVvOB-JGzFqn7hvkWin88
- Shakeel, A., Mahmood, H., Ullah, Z., Yasin, S., Iqbal, T., Chassagne, C. & Moniruzzaman, M. (2019). Rheology of pure ionic liquids and their complex fluids: a review. Retrieved from https://pubs.acs.org/doi/abs/10.1021/acssuscemeng.9b02232?fbclid=IwAR1Hw5h12e4_SLADAn3-C1D4783q3qX9DyywvumKun4et-OUMCbUXnjH-tg
- Soriano, A., Agapito, A., Lagumbay, L., Caparanga, A., & Li, M. (2010). A simple approach to predict molar heat capacity of ionic liquids using group-additivity method. *Journal Of The Taiwan Institute Of Chemical Engineers*, 41(3), 307-314. doi: 10.1016/j.jtice.2009.11.003
- Valderrama, J. O., Forero, L. A., & Rojas, R. E. (2012). Critical properties and normal boiling temperature of ionic liquids. Update and a new consistency test. *Industrial & engineering chemistry research*, 51(22), 7838-7844.
- Welton, T. (2018). Ionic liquids: a brief history. *Biophysical reviews*, 10(3), 691-706.
- Zhang, Q., Cai, S., Zhang, W., Lan, Y., & Zhang, X. (2017). Density, viscosity, conductivity, refractive index and interaction study of binary mixtures of the ionic liquid 1-ethyl-3-methylimidazolium acetate with methyldiethanolamine. *Journal of Molecular Liquids*, 233, 471-478.
- Zubeir, L. F., Romanos, G. E., Weggemans, W. M., Iliev, B., Schubert, T. J., & Kroon, M. C. (2015). Solubility and diffusivity of CO₂ in the ionic liquid 1-butyl-3-methylimidazolium tricyanomethanide within a large pressure range (0.01 MPa to 10 MPa). *Journal of Chemical & Engineering Data*, 60(6), 1544-1562.



A Preliminary Study on the Chiral Vector Approach in Determining the Optimum Structure of Carbon Nanotubes and its Correlation to the Chemical Potential Energy Using Avogadro

James Harris R. Bajande, Bren Daniel J. Ebriega, Justin Randolph N. Labios,
and Mike Lester D. Uy

De La Salle University Integrated School, Manila

Abstract: In this study, the following quantitative properties of carbon nanotubes were explored: the chiral vectors, which are numbers that describe the carbon nanotubes' structure, and properties such as chemical potential energy. The objective of this study is to simulate various carbon nanotube structures with chiral vectors that range from (0-3) and find a relation between these chiral vectors and the chemical potential energy. Using the software Avogadro, 12 carbon nanotubes with different chiral vectors (n, m) were simulated. These carbon nanotubes were of different lengths to keep the number of atoms in the molecules as close to 100 as possible. Avogadro was also used to calculate the theoretical chemical potential energy of these molecules. Using multiple correlation to analyze the simulations' data, an R2 value of 0.632 was obtained, which indicates a small positive linear association between them.

Key Words: carbon nanotubes; chiral vectors; chemical potential energy

1. INTRODUCTION

1.1. Background of the Study

Scientists have been studying carbon nanotubes (CNTs) for the past two decades because of their superior mechanical and electrical properties. In terms of structure, CNTs are a sheet of graphene rolled into a tube. CNTs can be classified as single-walled CNT (SWCNT), double-walled CNT (DWCNT), or multi-walled CNT (MWCNT), depending on the number of carbon-layers in their sidewalls (Schnorr & Swager, 2011).

An SWCNT is a hollow cylinder made up of covalently bonded carbon atoms arranged in a hexagonal pattern. Because of its atomic structure and unique carbon bond properties, the SWCNT has remarkable mechanical and electrical properties (Gao et al., 2021).

Additionally, different types of SWCNTs can be identified, except for their length, by the orientation of the tube axis relative to the carbon network. They are represented by the indices of their chiral vector, n and m (Schnorr & Swager, 2011). The CNT is an armchair when the chiral indices, n and m, are equal. On the other hand, the CNT is zigzag when either n or m is 0. Moreover, the CNT is chiral when their chiral indices are neither of these two (Kaushik & Majumder, 2015). Depending on their composition, CNT may also have metallic or semiconducting properties. The CNT is metallic if $n - m = 3q$ (where q is an integer and $n > m$) and semiconducting if not (J. Liu et al., 2017). The n and m integers precisely define

nanotube chirality and specify the electronic band structure. Hence, the chirality of carbon nanotubes has a significant impact on their electronic properties (Tune et al., 2012).

Further studies show that CNTs have received much interest because they are great at lowering resistance and improving the electrochemical efficiency of composite cathodes (Qin et al., 2014), which is the positive electrode of a battery (Battery University, 2020). Moreover, incorporating CNT into sulfur cathode gives rise to advanced electrodes with improved discharging capacity and cycling performance (L. Zhu et al., 2014).

Furthermore, as seen in batteries and electrochemical pseudocapacitors, energy storage technologies are based on the conversion of chemical potential energy to electrical energy, with the energy being stored in the form of chemical potential energy (C. Liu et al., 2016), which is the energy stored in the chemical bonds of a substance that can be absorbed or released due to a change of the particle number of the given species (CK-12 Foundation, 2021).

Consequently, in this study, the researchers focused on the SWCNT's structure, chiral vectors, and chemical potential energy.

Based on existing literature, no studies have been found regarding the use of virtual simulation to investigate the chemical potential energy of a CNT. Furthermore, no studies have been found describing the effects of changing a CNT's chiral vectors to its chemical potential energy. Despite the lack of existing studies, a molecular editor helped gather the necessary data in this research. Avogadro by



Avogadro Chemistry was the molecular editor used in this study.

This study aims to fill the gap in analyzing the relationship between chiral vectors and the chemical potential energy of CNTs, as this has not been determined in the existing literature. The study would enable future researchers to better determine the optimal CNT structure in possible energy-related applications such as battery electrodes (X. Liu et al., 2012).

1.2 Research Objective

This paper's main objective is to simulate a carbon nanotube structure using different chiral vectors to find a carbon nanotube structure that will yield the highest chemical potential energy with the same number of atoms. Existing literature was the basis for finding the optimal structure. Furthermore, the study aims to determine the relationship between the structures and the chemical potential energy.

1.2.1 Specific Objectives

- To accomplish this task, the researchers aim to do the following:
- Find the chiral vectors and make the pairings needed in building the CNT structure with a set number of 100 atoms
- Simulate different carbon nanotube structures with varying chiral vectors and get their chemical potential energy
- Sort data according to the structure that has the highest energy
- Use correlation to figure out the relationship between the chiral vectors and the energy

1.3 Scope and Limitations

This research was limited to only SWCNT structures as their electrical properties are significantly higher than those of (MWCNTs) (Zaytseva & Neumann, 2016). In addition to having a simpler structure and higher electrical characteristics than MWCNTs, SWCNTs are the most studied classification of CNTs both experimentally and theoretically (Laird et al., 2015). As this research was limited to single-walled carbon nanotubes, the researchers did not tackle the effects of varying numbers of walls. Moreover, the number of atoms was only normalized to see if a structure change was the cause and not the size of the molecules increasing. Hence, the researchers have limited the CNT's structure to have only 100 atoms each or 102 if 100 is not possible. Lastly, chiral values used were only from a range of 0-3.

1.4 Significance of the Study

This study contributes to the body of knowledge regarding carbon nanotubes' structures and their implications about their chemical potential energy that may be converted into other forms of energy, such as electrical energy. With the growing need for sustainable energy, this research may serve as a constituent in further research applying carbon nanotubes into batteries. In turn, this study could hopefully reveal new ways to use carbon nanotubes as a material viable for sustainable energy. The data and information gathered can also provide additional resources for future researchers. Furthermore, using simulation prevents unnecessary effort and laborious work. Lastly, since the simulation is in a virtual environment, it is cheaper and requires lesser materials and equipment than actual laboratory work.

2. METHODOLOGY

2.1. Research Design

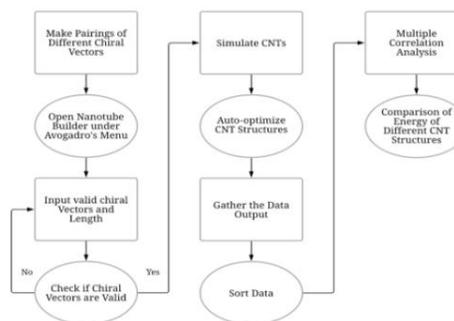

Figure 1. Flowchart of Methodology

Figure 1 was used as the flowchart for the entire methodology. The researchers have chosen Avogadro as the visualizer and simulator for the experiment, based on Hanwell et al. (2012). The virtual carbon nanotube (CNT) was built with varying chiral vector and length values using the "Nanotube Builder" available in Avogadro. This option was accessed through the "Build Menu" found in the Toolbar. The builder takes in input for chiral vectors n and m as well as length. The researchers tested different combinations of chiral vectors and length values using different CNT shapes as some chiral vector pairings are not possible.

This study made use of quantitative data, which was collected from Avogadro. After the researchers inputted the chiral vectors n and m , the output was three different types of CNT structures: zigzag, armchair, and chiral. After the CNTs were built, they used Avogadro's auto-optimization, which automatically optimized the CNT's geometry according to the inputted values of chiral vectors and



length. The final output was the final structure of the base CNT and its chemical potential energy.

The researchers only used Avogadro and had no other participants aside from themselves. Furthermore, the researchers only used the simulator mentioned above and mathematical means and tools to acquire their data. Thus, no ethical issues were violated in this study.

2.2. Data Collection Method

The primary data collected were the carbon nanotubes' structures based on the manipulated chiral vectors and the chemical potential energy produced that was determined by the CNT structure. The data was collected from the various simulations that were run in Avogadro. Each simulation had different chiral vector pairs (n,m). These values were selected by choosing a maximum value for the chiral vectors and producing every possible carbon nanotube with chiral vector values less than or equal to the chosen value. In this case, the chosen value was 3, which theoretically gives 16 different (n,m) pairs. However, there are certain (n,m) pairs that are not possible, these being (0,0), (0,1), (1,0), and (1,1). This is because either n or m has to be greater than 1. With this limitation in mind, 12 carbon nanotubes were simulated: (0,2), (0,3), (1,2), (1,3), (2,0), (2,1), (2,2), (2,3), (3,0), (3,1), (3,2), and (3,3), with the lengths modified to keep the number of atoms in the carbon nanotubes as close to 100 as possible to normalize the data as best as possible. After each simulation, the carbon nanotubes' geometries were further optimized. Once these geometries were as optimized as the software would allow, Avogadro automatically calculated and displayed the theoretical chemical potential energy (kJ/mol) produced by the setup.

Energy output in Avogadro's "Calculate Energy" is computed by a variation of the "force field," called Merck Molecular Force Field or MMFF94. MMFF94 is designed to deal with condensed-phase processes in molecular dynamics simulation and molecular geometry optimization in proteins and other biological systems (H. Zhu, 2014).

Avogadro uses the variant MMFF94s (Cornell & Hutchison, 2015). The "s" stands for static as this variant is better suited for time-averaged static molecular geometry (H. Zhu, 2014).

All simulations were done using an AMD Ryzen 5 3550H CPU, Nvidia GeForce GTX 1650 GPU, and 16GB of DDR-2400 RAM.

2.3 Data Collection Instruments

Avogadro is a free, open-source, and cross-platform molecule editor developed by Avogadro Chemistry. The program is written in C++, but Python scripts can be used as extensions to add functionality. Avogadro supports multithreading for rendering and

computation, which can reduce wait times on processors with multiple cores. However, GPUs cannot be used for hardware acceleration (Hanwell et al., 2012).

Avogadro has a robust feature set that allows it to create many different types of molecules, including a Nanotube Builder that can create different nanotubes depending on the parameters. It can also optimize molecules' geometry through the Optimize Geometry tool, which gives proper bond angles and lengths. The Auto Optimize tool also does this but continuously. Lastly, it can also calculate the energy of a system through its Calculate Energy function (Cornell & Hutchison, 2015).

2.4 Data Analysis

After collecting data, the researchers analyzed the chiral vectors used in creating the structure and energy produced by the carbon nanotubes and the structure of the CNT that was determined by the chiral vector. A chiral vector pair vs. energy graph was created to easily visualize the trend between the two variables and compare the difference in the energy output of different chiral vector pairs. The statistical tool used was a multiple correlation between the chemical potential energy and the chiral vectors that affect the structure of the CNT structure. A corresponding scatter plot was also used to visualize further the correlation between the two chiral vectors and energy. The unstandardized predicted value of the energy was used to account for the two chiral vectors, the independent variables. This was then plotted against the energy to create the scatter plot. The unstandardized predicted value was calculated after the equation of the line was determined since it is the value that the model predicted for the dependent variables (Penn State Eberly College of Science, 2018). To do this, the researchers opted to use Microsoft Excel and IBM SPSS Statistics to help analyze their data.

3. RESULTS AND DISCUSSION

3.1 Simulation Results

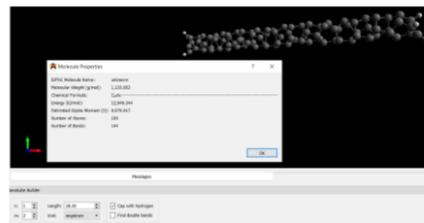

Figure 2. CNT with chiral vectors (1,2)

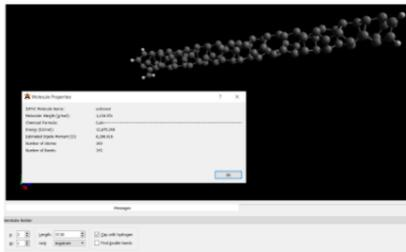

Figure 3. CNT with chiral vectors (2,1)

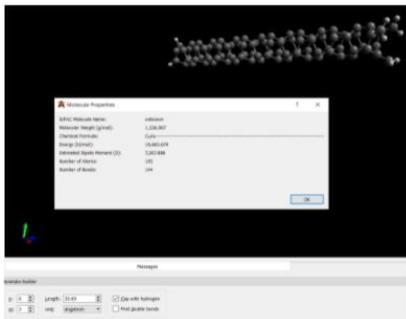

Figure 4. CNT with chiral vectors (0,3)

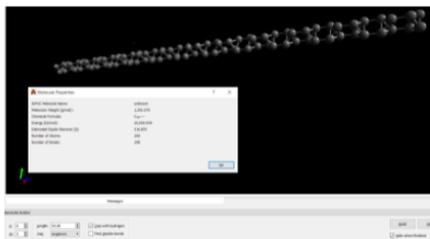

Figure 5. CNT with chiral vectors (0,2)

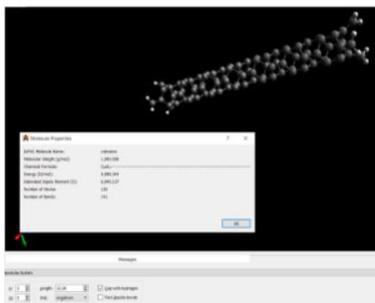

Figure 6. CNT with chiral vectors (3,0)

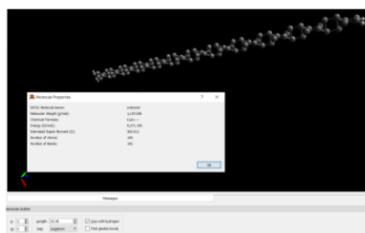

Figure 7. CNT with chiral vectors (2,0)

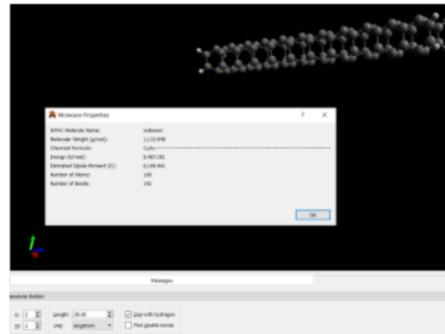

Figure 8. CNT with chiral vectors (2,2)

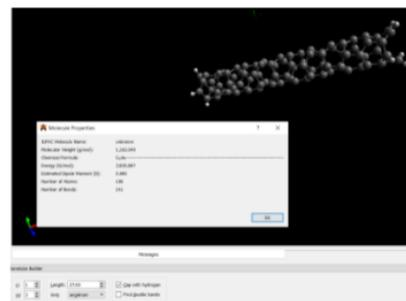

Figure 9. CNT with chiral vectors (1,3)

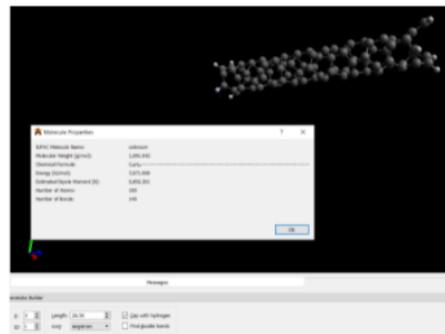

Figure 10. CNT with chiral vectors (3,1)

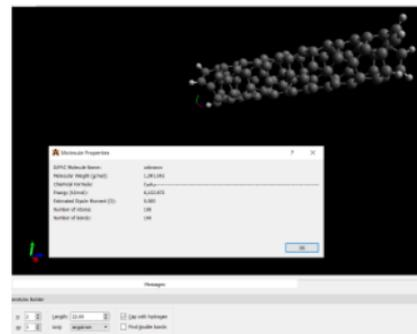

Figure 11. CNT with chiral vectors (2,3)

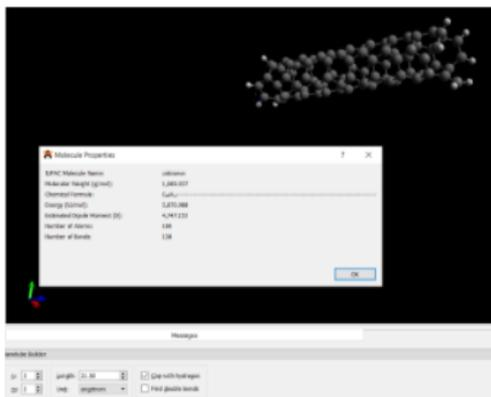

Figure 12. CNT with chiral vectors (3,2)

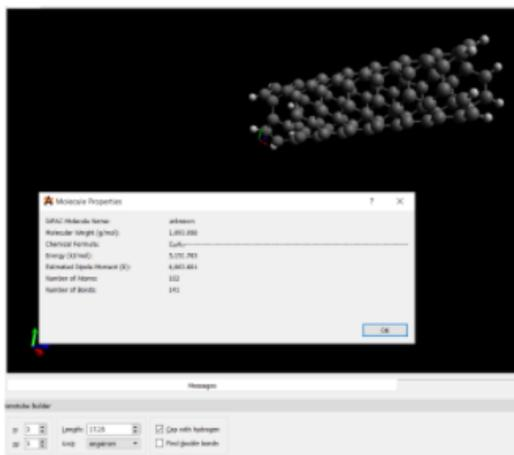

Figure 13. CNT with chiral vectors (3,3)

Figures 2-13 show each simulation of CNT with data regarding chiral vectors n and m , classification, number of atoms, number of bonds, CNT length (angstrom), molecular weight (g/mol), and chemical potential energy (kJ/mol). The structures are all set to 100 atoms except for some structures that have 102 because, as explained before, the next shortest value would be 96.

3.2 Primary observations

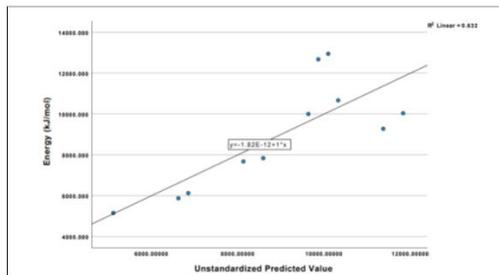

Figure 15. Linear regression of Energy vs. Unstandardized Predicted Value

In Table 1, the information about the CNTs with different structures and chiral vectors is displayed.

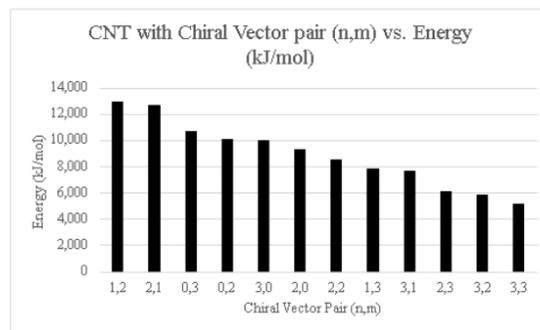

Figure 14. Bar graph comparing the energy values of each CNT

In previous research by Jing Liu et al. (2017), it was stated that CNTs that follow the trend of $n - m = 3q$, where q is an integer, are the most conductive while others are only semiconductive.

It can be seen in Figure 14 that two of the simulated CNTs were chiral and have the most energy, given that they have the same number of atoms. CNTs with (1,2) and (2,1) yield 12,946.344 kJ/mol and 12,675.248 kJ/mol respectively. These CNTs do not follow the trend indicated by the previous research in the previous paragraph. They both exceed two thousand kJ/mol more than the third-highest energy CNT, the (0,3). Moreover, it can be seen that different CNT structures produce different energy outputs, especially with the two armchair structures that have a difference of 3335.618 kJ/mol even though they have the same structure and the same number of atoms. Lastly, there is no obvious pattern that can be seen in the produced data. As the CNTs were made to have 100 atoms, with a few exceptions, it can be seen that the number of bonds, length, molecular weight, and energy are very different from one another and do not follow a specific trend.

3.3 Statistical Analysis

Figure 15 shows the scatter plot corresponding to the correlation between the two chiral vectors and the energy. The y-axis represents chemical potential energy (dependent variable), while the x-axis represents the two chiral vectors (independent variable). The dependent variable's unstandardized predicted value was used to account for the two independent variables and was plotted against the dependent variable. This produced an R^2 value of 0.632, consistent with the R^2 value in Table 2.



This R2 value of 0.632 is positive, which shows a small positive linear association between them (Kiernan, 2014).

4. CONCLUSIONS

Chiral vectors that range from (0-3) were paired up and used to make carbon nanotubes. Using the software Avogadro, only 12 carbon nanotubes with different chiral vectors were simulated successfully, which are (0,2), (0,3), (1,2), (1,3), (2,0), (2,1), (2,2), (2,3), (3,0), (3,1), (3,2), and (3,3). Since CNTs can only be made if one chiral vector is at least greater than 1, chiral vector pairs (0,0), (0,1), (1,0), and (1,1) are not possible inputs to create a CNT. Results were then sorted with the CNT, with the highest amount of energy being the first. Chiral CNTs with (1,2) and (2,1) yielded the highest energy of 12,946.344 kJ/mol and 12,675.248 kJ/mol, respectively. Using multiple correlation to analyze the simulations' data, an R² value of 0.632 was obtained, which indicates a small positive linear association between them.

In conclusion, this study showed the relationship between the chiral vectors and the chemical potential energy of CNTs. Further simulations can be made by identifying other structures not limited to CNTs. Another recommendation is to obtain the average for each structure and compare it to other literature on what applications it can be utilized.

5. ACKNOWLEDGMENTS

First and foremost, the researchers would like to express their deepest gratitude and most tremendous appreciation to the following persons who helped and guided them through the project. The researchers would like to thank Dr. Archie Maglaya, Sir Melchizedek Alipio, and Dr. Gil Nonato Santos, Ph.D., the research advisors who helped the researchers in the first part of their project and in polishing the paper. The researchers thank Ms. Liezl Rillera - Astudillo, the research coordinator, for guiding them in their research project's makings. The researchers thank the previous researchers who have conducted the necessary research for this research to be possible. Moreover, the researchers thank De La Salle University for allowing the researchers to fulfill this study and supporting them financially. The researchers express their gratitude to the parents, who constantly give them motivation and support them in any way possible. Lastly, the researchers thank the almighty God, who gave them the knowledge and courage to fulfill this research leading them to the right path.

6. REFERENCES

- Battery University. (2020, November 20). BU-104b: Battery Building Blocks – Battery University. Batteryuniversity.com. https://batteryuniversity.com/learn/article/bu_104b_building_blocks_of_a_battery
- CK-12 Foundation. (2021). CK12-Foundation. CK-12 Foundation; CK-12 Foundation. <https://flexbooks.ck12.org/cbook/ck-12-chemistry-flexbook-2.0/section/17.1/primary/lesson/chemical-potential-energy-chem>
- Cornell, T., & Hutchison, G. (2015). Learning Avogadro The Molecular Editor. Wustl.edu. <https://dasher.wustl.edu/chem430/software/avogadro/learning-avogadro.pdf>
- Gao, M., Bian, L., & Liang, X. (2021). Analysis for thermal properties and some influence parameters on carbon nanotubes by an energy method. *Applied Mathematical Modelling*, 89, 73–88. <https://doi.org/10.1016/j.apm.2020.07.041>
- Hanwell, M. D., Curtis, D. E., Lonie, D. C., Vandermeersch, T., Zurek, E., & Hutchison, G. R. (2012). Avogadro: An advanced semantic chemical editor, visualization, and analysis platform. *Journal of Cheminformatics*, 4(8). <https://doi.org/10.1186/1758-2946-4-17>
- Kaushik, B. K., & Majumder, M. K. (2015). Carbon nanotube based VLSI interconnects: Analysis and design. *SpringerBriefs in Applied Sciences and Technology*, 9788132220466, i–iv. <https://doi.org/10.1007/978-81-322-2047-3>
- Kiernan, D. (2014, January 16). Chapter 7: Correlation and Simple Linear Regression. Geneseo.edu; Open SUNY Textbooks. <https://milnepublishing.geneseo.edu/natural-resources-biometrics/chapter/chapter-7-correlation-and-simple-linear-regression/>
- Laird, E. A., Kuemmeth, F., Steele, G. A., Grove-Rasmussen, K., Nygård, J., Flensberg, K., & Kouwenhoven, L. P. (2015). Quantum transport in carbon nanotubes. *Reviews of Modern Physics*, 87(3), 703–764. <https://doi.org/10.1103/RevModPhys.87.703>
- Liu, C., Neale, Z. G., & Cao, G. (2016). Understanding electrochemical potentials of cathode materials in rechargeable batteries. *Materials Today*, 19(2),



109–123.

<https://doi.org/10.1016/j.mattod.2015.10.009>

Liu, J., Lu, J., Lin, X., Tang, Y., Liu, Y., Wang, T., & Zhu, H. (2017). The electronic properties of chiral carbon nanotubes. *Computational Materials Science*, 129, 290–294. <https://doi.org/10.1016/j.commatsci.2016.12.035>

Liu, X. M., Huang, Z. dong, Oh, S. woon, Zhang, B., Ma, P. C., Yuen, M. M. F., & Kim, J. K. (2012). Carbon nanotube (CNT)-based composites as electrode material for rechargeable Li-ion batteries: A review. *Composites Science and Technology*, 72(2), 121–144. <https://doi.org/10.1016/j.compscitech.2011.11.019>

Penn State Eberly College of Science. (2018). 2.1 - What is Simple Linear Regression? | STAT 462. [Psu.edu. https://online.stat.psu.edu/stat462/node/91/](https://online.stat.psu.edu/stat462/node/91/)

Qin, G., Ma, Q., & Wang, C. (2014). A porous C/LiFePO₄/multiwalled carbon nanotubes cathode material for Lithium ion batteries. *Electrochimica Acta*, 115, 407–415. <https://doi.org/10.1016/j.electacta.2013.10.177>

Schnorr, J. M., & Swager, T. M. (2011). Emerging applications of carbon nanotubes. *Chemistry of Materials*, 23(3), 646–657. <https://doi.org/10.1021/cm102406h>

Tune, D. D., Flavel, B. S., Krupke, R., & Shapter, J. G. (2012). Carbon nanotube-silicon solar cells. *Advanced Energy Materials*, 2(9), 1043–1055. <https://doi.org/10.1002/aenm.201200249>

Zaytseva, O., & Neumann, G. (2016). Carbon nanomaterials: Production, impact on plant development, agricultural and environmental applications. *Chemical and Biological Technologies in Agriculture*, 3(1), 1–26. <https://doi.org/10.1186/s40538-016-0070-8>

Zhu, H. (2014, April 28). Implementation and application of the MMFF94 force field. [Unl.edu. https://digitalcommons.unl.edu/cgi/viewcontent.cgi?article=1047&context=chemistrydiss](https://digitalcommons.unl.edu/cgi/viewcontent.cgi?article=1047&context=chemistrydiss)

Zhu, L., Zhu, W., Cheng, X. B., Huang, J. Q., Peng, H. J., Yang, S. H., & Zhang, Q. (2014). Cathode materials based on carbon nanotubes for high-energy-density lithium-sulfur batteries. *Carbon*, 75, 161–168. <https://doi.org/10.1016/j.carbon.2014.03.049>



The Effect of Coconut Fiber as Concrete Reinforcement on Abrasion Resistance and Water Permeability

Karl Andre F. Aquino, Marie Bernadette B. Lasay, Jesus E. Acuña,
and Armaine Lizbeth B. Herbon
De La Salle University Integrated School, Biñan City, Laguna

Abstract: The quality of infrastructure in the Philippines is one of the lowest amongst its neighboring countries. This is affected by the materials used in construction such as concrete. The mechanical and durability properties of concrete can be improved with fiber reinforcements. Coconut fiber is known to be the most ductile from all natural fibers, and the Philippines is a major producer of coconut. The study aims to determine the effect of coconut fiber on concrete reinforcement by examining its abrasion resistance and water permeability. The samples were cured for 28 days after setting and subjected to abrasion resistance and water permeability tests. The abrasion resistance decreased with higher fiber content; however, fiber content equal to or lower than 2.5% had higher resistance as compared to normal concrete. The water permeability of samples increased along with the coconut fiber content, with a significant increase observed in fiber contents equal to above 5%. The best overall results were achieved with CFRC containing 2.5% fiber content.

Key Words: concrete; coconut fiber; abrasion resistance; water permeability

1. INTRODUCTION

Infrastructures in the Philippines are mostly outdated and lacking. According to IMF Focus (2020), the Philippines, in terms of infrastructure quality, is below most of the other neighboring countries. As the Philippines plan on increasing its budget allocated to public infrastructure with the Build, Build, Build program, their aim is to improve the overall quality to lessen the impact of climate-related disasters.

According to Burton (2018), the Philippines is the second-largest producer of *Cocos nucifera* or coconut in the world, producing over 150 million tons of coconut with a quarter of its total farmland dedicated to coconut production. However, the percentages of husk utilization for coir production in the three major islands of the Philippines are all below 55%, with more than 45% of the coconut husks produced are unutilized (Pogosa et al., 2018).

Copious studies concerning the mechanical properties of coconut fiber as concrete reinforcement are already evident. As exhibited in the paper of Onuaguluchi & Banthia in 2010, there are yet more studies to determine the durability properties of the said fiber (i.e., abrasion resistance and water permeability). Thus, this research focused on the stated durability properties of coconut fiber-reinforced concrete (CFRC).

According to Aziz in 1981, other well-known natural fiber reinforcements (e.g., sisai, sugarcane bagasse, bamboo, juta, wood, akwara, elephant grass, water-reed, plantain, and musamba) are heavily used and ensure many benefits (i.e., improved tensile and

compressive strength, post cracking resistance, high energy absorbing characteristics and fatigue strength). However, in comparison to all natural fibers, coconut fiber is reaffirmed to be the most ductile (Aditya, Anushree, Varghese, & Antony, 2015).

This study aims to produce CFRC containing 0%, 2.5%, 5%, 7.5% coconut fiber content by weight which was to be cured for 28 days. The samples were then tested to assess the durability of CFRC in terms of abrasion resistance and water permeability.

2. METHODOLOGY

2.1. Materials

The chemicals used were silica fume for durability and superplasticizer as a high range water reducer. The equipment used are as follows: (a) the Belt Sander from Black+Decker Model DS321; (b) the Digital Weighing Scale Model SF-400; (c) the Digital Kitchen Scale from KONCO, which was used for obtaining specific measurements; and (d) a sieve mesh, which is a mesh made of metal, fiber, or cloth, assembled to provide defined opening. The raw materials used for the mixture were Type 1 Portland cement from CEMEX, gravel, sand, drywall, wood planks, and coconut fiber. The coconut fiber was treated by first cleaning it with water; then, it was subjected to 200° C in an oven for 30 min or until constant weight is attained.

2.2. Research Design

In this study, the researchers aimed to answer whether coconut fiber reinforcement can affect the abrasion resistance and water permeability of concrete as well as which amount would yield the best results. A total of 24 rectangular slab samples with dimensions 120 x 70 x 50 mm were made and cured for 28 days. The samples were labeled as shown in Table 1. There were two experimental setups prepared: the abrasion resistance test setup and the water permeability test setup.

Table 1. ID and quantity of samples

Sample ID	Description	Quantity
CFRC-0	Control concrete samples with 0% fiber content	6
CFRC-2.5	CFRC samples with 2.5% fiber content	6
CFRC-5	CFRC samples with 5% fiber content	6
CFRC-7.5	CFRC samples with 7.5% fiber content	6

2.3. Concrete Samples

The ratio for the materials used in the mixture were 2.60:3.90: 3.90:0.90:0.26:0.03 for the mixing of cement, sand, gravel, water, silica fume, and superplasticizer. The mixture ratio was based on the study of Ahmad et al. (2020) wherein they have improved the mechanical properties of concrete with the use of coconut fiber as reinforcement. The mixture was cast in a 120 x 70 x 50 mm concrete mold made from drywall; a diagram of the mold is shown in Figure 1. After setting, it was removed from the mold and cured for a minimum of 28 days. A total of 24 concrete blocks were prepared to conduct the abrasion resistance and water permeability tests.

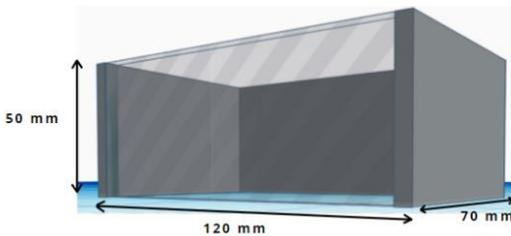

Figure 1. Diagram of Mold Dimensions

2.4. Sample Testing

Figure 2 shows the experimental setup for the abrasion resistance test based on the test method coming from the American Society of Testing and Materials (ASTM), specifically ASTM C779 Method A

(Kumar & Sharma, 2014). It is an alternative method of testing devised from ASTM C779 wherein a constantly rotating abrasive surface is applied on the sample using a belt sander with wood planks used as support. It utilizes the wood planks as support for the sample and the belt sander to abrade the surface. The weight of the samples at intervals of 0 min, 5 min, 10 min, and 15 min as well as the cross-section of the samples were observed.



Figure 2. Abrasion Resistance Test Setup

Figure 3 shows the experimental setup for the water permeability test based on ASTM C642-06. The setup is based on ASTM C642-06 wherein the samples are required to be a minimum of 350 cm³ and dried in an oven at 200°C for a minimum of 45 minutes or until constant weight is attained. The samples were then submerged for intervals of 0 h, 0.5 h, and 72 h wherein the weight was recorded. The volume of permeable voids (Pv%) was then calculated with the formula provided in ASTM C642-06, $Pv\% = \frac{(W_f - W_i)W_f}{100}$, wherein W_i is the initial weight, and W_f is the final weight of the sample.



Figure 3. Water Permeability Test Setup

3. RESULTS AND DISCUSSION

3.1 Abrasion Resistance

Abrasion resistance (AR) of concrete can determine its survivability in abrasive environments. During the AR test, all samples exhibited no loss in their height. Furthermore, in the sample with the highest percentage, larger cracks and holes can be found within the cross-section of the concrete, which is displayed in Figure 4. The weight of the samples in all intervals is shown in Figure 5.

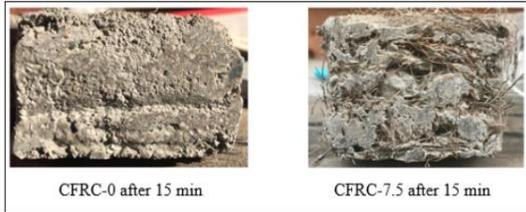

Figure 4. A comparison of the cross-section of CFRC-0 and CFRC-7.5

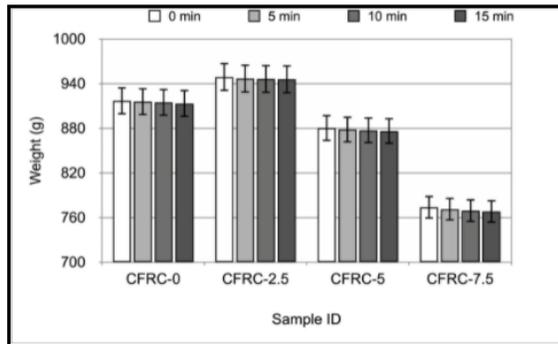

Figure 5. Avg. weight at intervals during AR tests

Figure 6 shows the average weight loss, initial weight - final weight, during the abrasion resistance test for each of the samples. The data shows that the highest fiber content, i.e., 7.5%, also had the most total weight difference amongst all samples, which suggests that it is the least resistant amongst all samples. Furthermore, all CFRC samples observed a lower resistance during the first 5 min, having the most weight loss whilst it diminishes as it is exposed to abrasion for longer periods of time. However, the control samples observed a constant loss in weight after each interval. Hence, the said observation asserts that the fiber content of CFRC has an inverse relationship with its abrasion resistance.

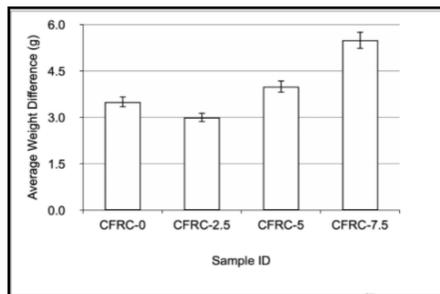

Figure 6. Avg. weight difference of all samples after AR test

3.2 Water Permeability

The water permeability (WP) of concrete can affect its durability as higher rates of absorption will allow molecules to make the structure unstable, whilst lower rates would mean a stronger resistance against fluids. These rates are affected by the volume of permeable voids an object has. Figure 7 shows the average weight of the samples in each interval from 3 trials of the WP test. There was a significant weight difference among samples of the same type. These may be due to the inconsistency of pouring the mixture during molding and casting. As shown in Figure 7, all samples showed a significant increase in weight during the first 30 min of water submersion. After 72 h, the weight of all samples showed a smaller increase as compared to the first 30 min.

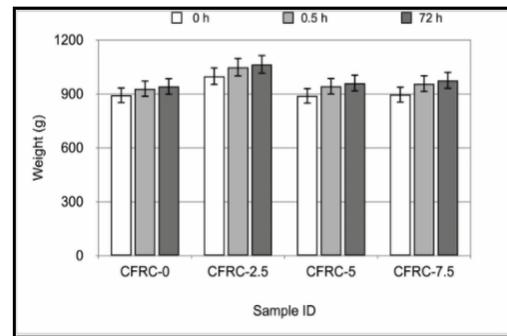

Figure 7. Avg. weight at intervals during WP tests

The results show that samples with higher fiber content have a higher percentage of permeable voids, refer to Figure 8. These are similar to those from the study of Rao et al. (2015), wherein concrete with coconut shell aggregate added to its mixture showed a higher volume of permeable voids as compared to normal concrete. The higher percentage indicates that the water absorption rate also increases along with fiber content. Thus, the fiber content should not increase by 2.5% fiber content. The samples CFRC-5 and CFRC-7.5 are more susceptible to internal damage while CFRC-2.5 only has a slight increase in permeable voids as compared to the CFRC-0. Figure 8 shows the general increase in permeable voids as the fiber content increases.

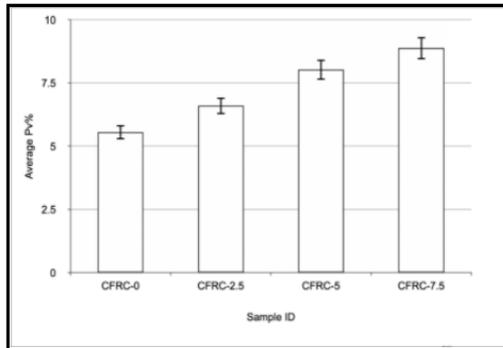

Figure 8. Permeable voids in samples

The significant increase in the volume of permeable voids on samples with more than 2.5% fiber content indicates that the reinforcement of concrete with coconut fibers should be no more than 2.5%. According to Ahmad et al. (2015), the CFRC with 1.5% fiber content provided the best results in terms of mechanical properties, and they have also stated that any more than that showed fewer improvements.

4. CONCLUSIONS

The study has shown the effects of coconut fiber as concrete reinforcement. In the abrasion resistance test, the findings suggest that high fiber content leads to lower abrasion resistance. The data also asserted that CFRC can withstand abrasive environments in longer time intervals since its abrasion resistance increases over time unlike the control sample. Thus, it is recommended that the fiber content of the CFRC must stay within 2.5% to ensure the highest abrasion resistance of the sample. Furthermore, in the water permeability test, the results suggest that fiber content less than 2.5% is recommended as it will decrease the risk of damage and be more effective. Overall, the reinforcement of concrete with coconut fibers at 2.5% fiber content or lower will improve abrasion resistance whilst avoiding major increase in permeable voids. With that said, it is recommended for future research to focus on the proper mixing and curing processes for CFRC along with the placement and orientation of fibers during its production as means to lessen the cracks and voids found within the concrete.

5. ACKNOWLEDGMENTS

The researchers would like to thank their research adviser Dr. Kerry P. Cabral for the guidance and help throughout the research process..

6. REFERENCES

Aditya, T., Anushree, S., Varghese, D. & Antony, J. (2015). Coconut Fibre - A Versatile Material and its Applications in Engineering. Main Proceedings ed. <https://doi.org/10.1.1.823.5053>

Ahmad, W., Farooq, S. H., Usman, M., Khan, M., Ahmad, A., Aslam, F., Yousef, R. A., Abduljabbar, H. A. & Sufian, M. (2020). Effect of Coconut Fiber length and Content on Properties of High Strength Concrete. Main Proceedings ed. <https://doi.org/10.1.1.823.5053>

Ali, M., Liu, A., Sou, H. & Chow, N. (2012). Mechanical and dynamical properties of coconut fiber reinforced concrete. *Construction on and Building Materials*, 30, 814-825. https://www.academia.edu/17539220/Mechanical_and_dynamic_properties_of_coconut_fiber_reinforced_concrete

ASTM C642-06. (n.d.). Standard Test Method for Density, Absorption, and Voids in Hardened Concrete. ASTM International. <ftp://ftp.ecn.purdue.edu/olek/PTanikela/To%20Prof.%20Olek/ASTM%20standards/Density%20absorption%20and%20voids%20in%20hardened%20concrete%20C%20642.pdf>

Aziz, M. A., Paramasivam, P., & Lee, S. L. (1981). Prospects for natural fibre reinforced concretes in construction. *International Journal of Cement Composites and Lightweight Concrete*, 3(2), 123–132. doi:10.1016/0262-5075(81)90006-3

Balakrishna, M. N., Mohamad, F., Evans, R. & Rahman, M. M. (2019). Assessment of water absorption of concrete by Initial surface absorption test. https://www.researchgate.net/publication/330597539_Assessment_of_water_absorption_of_concrete_by_initial_surface_absorption_test

Burton, J. (2018). The World Leaders in Coconut Production. <https://www.worldatlas.com/articles/the-world-leaders-in-coconut-production.html>

IMF Country Focus. (2020). The Philippines: A Good Time to Expand the Infrastructure Push. <https://www.imf.org/en/News/Articles/2020/02/06/na020620the-philippines-a-good-time-to-expand-the-infrastructure-push>

Kumar, G. B. R. & Sharma, U.K. (2014). Standard Test Methods for Determination of Abrasion



Resistance of Concrete. *International Journal of Civil Engineering Research*, 5(2), 15-162. https://www.ripublication.com/ijcer_spl/ijcerv5n2spl_09.pdf

Lee, K. (2017). The Philippines: Infrastructure Opportunities and Challenges. <https://hkmb.hktdc.com/en/1X0ABULX/hktdc-research/The-Philippines-Infrastructure-Opportunities-and-Challenges>

Onuaguluchi, O., & Bantia, N. (2016). Plant-based natural fibre reinforced cement composites: A review. *Cement and Concrete Composites*, 68, 96–108. doi:10.1016/j.cemconcomp.2016.02.014

Pogosa, J. O., Asio, V. B., Bande, M. M., Bianchi, S., Pichelin, F. & Grenz, J. (2018). Productivity and Sustainability of Coconut Production and Husk Utilization in the Philippines: Coconut Husk Availability and Utilization. *International Journal of Environmental and Rural Development*, 9(1), 31-35. https://www.researchgate.net/publication/332259191_Productivity_and_Sustainability_of_Coconut_Production_and_Husk_Utilization_in_the_Philippines_Coconut_Husk_Availability_and_Utilization

Rao, K. V., Swaroop, A. H. L., Rao, P. K. R. & Bharath, C. N. (2015). Study on strength properties of coconut shell concrete. *International Journal of Civil Engineering and Technology*, 6(3), 42-61. http://www.iaeme.com/MasterAdmin/uploadfolder/IJCIET_06_03_005/IJCIET_06_03_005.pdf



Analyzing the Depictions of Queer Struggles in Selected Asian BL Series

Chandrea Elise C. Uy
Philippine Cultural College, Manila

Abstract: Media texts depicting same-sex relationships among men long existed in ancient China in 206 BCE-220 BCE. The term BL or Boys Love was first coined in the 90s in Japan through mangas or Japanese comics and movies; it has since been steadily gaining fans from across the globe. During the 2020 COVID-19 pandemic, which forced people around the globe to stay at home, the BL genre saw increased viewership from 5% to 34% on various streaming platforms. Most of these shows depict various struggles experienced by queer characters. SOTUS (2016), Gameboys (2020), and Dark Blue and Moonlight (2017) are three well-known BL series from Thailand, the Philippines, and Taiwan. This study aims to identify the struggles depicted in these series, compare and contrast the struggles, and characterize the queer characters struggling. The television programs were analyzed using the queer theory, coding framework, and textual analysis. The findings show that most of the struggles depicted centered around acceptance of the self, acceptance by others, and managing one's feelings. The characters from these BL series also share the same characteristics, such as how they respond to problems and their struggles.

Key Words: Boys love, queer struggles, media portrayal, Filipino BLs, Taiwanese BLs, Thai BLs

1. INTRODUCTION

Background of the Study

As the years pass by, the idea of being queer is slowly being accepted. Thus, shows and films that depict relationships between queer people emerged as a genre in contemporary media. Most of these shows are produced in Thailand and star cisgender male actors. Early depictions of queer people can be found in ancient China where it is generally accepted. Being queer started to be viewed negatively because of Western influences during the Qing dynasty (Kang, 2009). The term "BL" or Boy's love was first introduced in Japan during the 90s through mangas and novels (Olsen, 2020). The BL genre gained a following in Taiwan, Thailand, and China. It first came to Thailand in the form of novels. Due to the constant demand for BL content, Love Sick: The Series was one of the first few Thai BL shows produced in 2014. The BL genre started gaining popularity in 2014-2015 (Boonorana, 2020, as cited in Koaysomboom, 2020).

2020 marked the highest increase in viewership of BL series across different streaming platforms, with viewership increasing from 5% to 34% during the pandemic. The vice president of LINETV, one of the leading streaming platforms for BL series states that BL during this time may not be a sub-genre anymore; it is gradually going mainstream (Koaysomboom, 2020).

This study aims to identify and analyze the queer struggles present in the selected Asian BL series.

1.2. Theoretical Framework: Queer Theory

The 1990 theory developed by Butler states that human relationships are not derived from the body's biological separation (sex) but are derived from a person's portrayal of gender (sexuality). One of the ideas which queer theory rejects is heteronormativity, or the assertion that heterosexuality is the default sexuality in society. Most of the struggles depicted in the selected series are founded on Asian society's heteronormative standards. Asian societies generally emphasize producing a biological heir or family lineage (Raymo, et.al, 2015). This theory is applicable due to its relevance in the major themes depicted in the selected BL series.

1.3. Statement of the Research Problem

This research aims to compare the depiction of struggles experienced by the queer community in three BL series from Thailand, the Philippines, and Taiwan, namely SOTUS: The Series (2016), Gameboys (2020), and Dark Blue & Moonlight (2017). It seeks to answer the following questions:

1. What are the struggles experienced by the main characters portrayed in the selected BL

series?

2. How are the struggles depicted in the selected BL series from different Asian countries similar and different from each other?
3. How are queer men depicted dealing with these struggles in the selected BL series?

2. METHODOLOGY

2.1. Research Design

The study utilized a qualitative approach and incorporated the use of a memoing sheet and textual analysis. It is a descriptive research whose goal is to provide an accurate account of an individual's characteristics, situation, or group. Descriptive research can offer a deeper understanding of a situation as it naturally occurs (Dullock, 1993). This study aims to identify and analyze the struggles experienced by the queer characters; hence the chosen approach is the most appropriate.

2.2. Data Gathering Procedures

This study's data was gathered from the three selected BL series to be analyzed, namely SOTUS: The Series, Gameboys, and Dark Blue & Moonlight. The series were chosen according to their popularity and explicit depictions of struggling as queer men. These were also chosen because of the similar nature of the issues present in the series.



Textual analysis was utilized to compare the depictions of struggles in the selected series. The researcher conducted three viewings to analyze scenes wherein there is a significant and explicit depiction of queer struggles.

The first viewing consisted of the researcher getting the gist or summary of the selected dramas. In the second viewing, the memoing sheet was used to note the important details, such as how the struggles were depicted and how the characters dealt with the struggles. The third and final viewing was a review in case some details were missed.

3. RESULTS AND DISCUSSION

3.1. Comparing the Struggles

The most similar characters with almost identical issues are Arthit from SOTUS and Cai from Gameboys. Both are depicted as full of doubts about themselves and fear of what others may think about them. They both hid their feelings at first because they did not want to let others see their vulnerability. Cai and Arthit were aggressive or unfriendly towards Gav and Kongpob, respectively. Nevertheless, towards the end, both warmed up to their respective significant others and started to show warmer and friendlier emotions. In terms of personal struggles, both Cai and Arthit mentioned that they had been confused about their sexuality. Cai mentioned this in a scene where he recalled that moment when Riza had publicly outed him as gay. Arthit, on the other hand, was not that verbal about his state of confusion and instead conveyed it through his actions. He avoided Kongpob whenever his feelings of confusion intensified, specifically concerning whether he was queer and had feelings for Kongpob. The only time Arthit had opened up about his inner battle between his feelings for Kongpob and thoughts of rejection from others was when he talked to his friend.

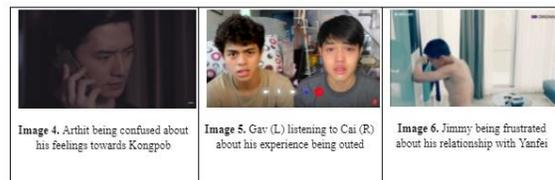

The three selected shows depict all three categories of struggles: personal, emotional, and social. However, some categories of struggles are not emphasized. The struggles depicted in SOTUS were primarily personal ones as they dealt with Arthit's confusion with his sexuality. The struggles shown in Gameboys are primarily emotional as Cai was dealing with his father's condition and the COVID-19 pandemic. Dark Blue and Moonlight's main struggles can be categorized into social struggles since Yanfei and Jimmy had to hide their relationship from Yanfei's mother.

One common struggle among the three series is the idea of coming out as queer and being accepted by society. Arthit in SOTUS was worried about how people would think of him when he came out as queer. Cai had trouble coming out to his family and was even outed by his friend, causing him to leave home due to the fear of getting rejected. In Yanfei's case in Dark Blue and Moonlight, he feared coming out and being rejected by his mother.

3.2. Protagonists' Responses



Arthit's typical responses to his struggles were aggression, hostility, or avoidance. As shown in certain scenes, when Kongpob confessed to Arthit about his feelings, he avoided Kongpob. In a scene where Arthit was jealous of a close friend with Kongpob, he acted aggressively towards Kongpob. Arthit talked to his friend with the hopes of getting advice on what he should do. Cai from *Gameboys*' responses to his problems were quite similar with Arthit's responses. When being teased by Gav, Cai usually responded with an irritated tone, like how Arthit does. Both characters also show significant developments throughout their whole series. When faced with a problem involving Gav, Cai always listened to others before Gav, causing him to jump to his own conclusions along with his insecurities. Like Arthit, Cai also opened up to someone about his struggles as being out as queer.



Image 9. Yanfei attacking the coach

Physical violence is not emphasized in *Gameboys* and *SOTUS*. However, when Yanfei witnesses someone using a derogatory word for queer people, he resorted to violence, physically attacking that person. In Episode 5, when Jimmy outed Yanfei to his mother, their immediate response was to be physical against one another. Arthit, Yanfei, and Jimmy all shared the same response when encountering problems with their significant others. They tended to be passive and hide their genuine opinions and feelings. In a scene from Episode 5, Yanfei pretended not to care about Jimmy being distant. However, when alone, he was visibly affected by it. Jimmy also had a similar response in Episode 9 when he and Yanfei met again but as ex-lovers. He pretended that he had moved on from Yanfei but suddenly cries when alone.

3.3. Media vs. Real Life

The most emphasized theme which was common among the three selected series is the idea of coming out. Coming out was seen in *Gameboys* when Cai was outed to his family. Similarly, in *SOTUS*, Arthit was having doubts about whether the people around him could accept his sexuality before coming out to his friends. In *Dark Blue and Moonlight*, Yanfei wouldn't come out to his mother because he knew that he would not be accepted. The protagonists' struggles related to coming out are consistent with the findings of Wei and Liu (2018) when they suggest that majority of the LGBT students in China were not comfortable coming out as queer.



Cai's mother in *Gameboys* was supportive of her son's sexuality as opposed to Yanfei's mother in *Dark Blue and Moonlight*. Both women's ages are not explicitly stated in their respective series. Cai's mother can be assumed to be in her 40s-50s, while Yanfei's mother could possibly be in her senior years, around 60s-70s. Pew Research Center's 2007-2019 study findings support these depictions as their findings assert that acceptance of the LGBT community varies from generation to generation, with the older generation being less supportive and the younger generation being more accepting. The portrayal of Cai's mother being accepting of her son's sexuality is also supported by Pew Research Center's data, in which they find out that the Philippines had the highest acceptance rate of the LGBT community in Asia.



The deviation from different masculine standards can be seen across the three selected series. Each of them has points which they emphasize based on the societies of their country of origin. Students from Thai universities put importance on the concept of authority and seniority through initiation rites or hazing sessions. Seniors who do the hazing, mostly male students, are expected to be masculine, aggressive, and cruel towards the juniors. Arthit from *SOTUS*, in some scenes, was depicted to be aggressive towards his juniors; however, he was also depicted as



someone who deviates from the aggressive and masculine image of senior hazers. Arthit was shown as someone who likes pink milk, a drink considered to be feminine in Thailand; hence when Kongpob pointed this out, he was embarrassed. In the latter part of the series, Arthit's soft side was more prominent. He became gentler and showed vulnerability in terms of expressing his true feelings.



Image 14. Cai being outed on social media by his friend



Image 15. Cai's brother (L) and Cai (R) talking about their father's situation

In Philippine society, a man is expected to be the breadwinner and provider of the needs of his own family. The ability of a man to provide for his family serves as the basis of how masculine he is seen in society. In terms of religion, the majority of the Philippines is Catholic. One of the core beliefs in Catholicism is that being queer is a sin. Because of this belief, queer people are often discriminated against; being straight became the usual and default sexuality. When Cai was outed to his family as gay, he was ashamed and left his home. Cairo, as a man, felt like he could not deliver to his parents' standards of him; hence he apologized to his mother for being gay.



Image 16. Yanfei and Jimmy talking about work



Image 17. Jimmy (L) and Yanfei (R) talking about their breakup

In the present times, Confucian ideas are still seen in modern Taiwan. Confucianism has always been patriarchal; in an ideal Confucian household, there is a husband, wife, and their children. The man or father is expected to lead the household while the wife and children obey him. Yanfei's mother in *Dark Blue and Moonlight* upholds this belief when she tells Jimmy and Yanfei to find wives. Jimmy from *Dark Blue and Moonlight* deviates from this Confucian thinking as the family Jimmy visualizes consists of two men and their adopted children when the subject of having children is brought up.

4. CONCLUSIONS

BLs, regardless of country of origin, in a broader sense, share almost the same struggles and characterization. Arthit from *SOTUS* and Cai from *Gameboys* share the most similarities with the way they act and respond to certain situations. Additionally, it was found that the major themes and

struggles depicted in the selected BL series are reflective of the current status quo of the LGBT community in Asia. Based on the findings and previous studies, most of them support each other's ideas, such as generational differences in views and heteronormativity in Asian society.

5. ACKNOWLEDGMENTS

The research proponent would first like to thank her research adviser, Mr. Roberto Lim Jr., for giving her his time and effort and sharing his knowledge. Without his guidance, this research wouldn't be completed. She would also like to extend her gratitude to her research tool validator, Mr. Daryl Teves, for taking the time to validate her research tools.

She would also like to thank her oral defense panelists, Dr. Sining Kotah, Mr. Leonard Catubay, and Mx. Clark Leynes, for their precious time and effort in critiquing this paper. The research proponent also is grateful to the PCC HUMSS batch 2021 for providing emotional and moral support to her. She would also like to thank her parents for their never-ending encouragement and support. Without them, she would not have completed this study.

6. REFERENCES

Allen, M. (2017). *The sage encyclopedia of communication research methods* (Vols. 1-4). Thousand Oaks, CA: SAGE Publications, Inc. doi: 10.4135/9781483381411

Berkowitz, A., Chennault, C., Dien, A., & Knapp, K. (2015). *Early Medieval Chinese texts*. Berkeley: Institute of East Asian Studies University of California. pp. 44-47

Cook, M. (2018), "A content analysis of LGBT representation on broadcast and streaming television" University of Tennessee at Chattanooga

Cregan, K. (2012). *Queer*. In *Key concepts in body and society* (pp. 153-156). SAGE Publications Ltd, <https://www.doi.org/10.4135/9781473914650.n35>

Dulock, H.L. (1993). *Research Design: Descriptive Research*. *Journal of Pediatric Oncology Nursing*. 1993;10(4):154-157. doi:10.1177/104345429301000406

Fursich, E. (2018). *Textual Analysis and Communication*. obo in Communication. doi: 10.1093/obo/9780199756841-0216

Garcia, J. (2009). *Philippine gay culture: the last thirty years : binabae to bakla, silahis to MSM*. Hong Kong: Hong Kong University Press

Harris, A. (2019) *What Are Queer Coding and Queerbaiting?* (2019, September 2). *Her Campus*.



- <https://www.hercampus.com/school/utah/what-are-queer-coding-and-queerbaiting>
- Hinsch, B. (1990). *Passions of the Cut Sleeve: The Male Homosexual Tradition in China*. Berkeley: University of California Press, xvii, 232 pp.
- Kang, W. (2009). "Obsession: male same-sex relations in China, 1900-1950" History Department Books. 9.
- Koaysomboon, T. (2020). Everything you need to know about Thailand's thriving Boys Love culture. Time Out Bangkok. Retrieved 25 March 2021, from <https://www.timeout.com/bangkok/lgbtq/thai-boys-love-culture>.
- Mampusti, E. (2020, June 23). What's The Trending BL Series All About? Clozette. <https://www.clozette.co/article/what-are-bl-series-cj-7061>
- Olsen, C. (2020). The History of BL (Boys' Love). Retrieved 17 March 2021, from <https://yattatachi.com/history-of-boys-love>
- Poushter, J., & Kent, N. (2020, June 25). The Global Divide on Homosexuality Persists. Pew Research Center's Global Attitudes Project. <https://www.pewresearch.org/global/2020/06/25/global-divide-on-homosexuality-persists/>
- Raymo, J., Park, H., Xie, Y., & Yeung, W. (2015). Marriage and Family in East Asia: Continuity and Change. *Annual Review Of Sociology*, 41(1), 471-492. <https://doi.org/10.1146/annurev-soc-073014-112428>
- Tang, X., & Poudel, A.N. (2018). Exploring challenges and problems faced by LGBT students in the Philippines: A qualitative study.
- Tawil, Y. (2020, July 3). What Exactly is Media Representation Anyway? Arab Film and Media Institute (AFMI). <https://arabfilminstitute.org/what-exactly-is-media-representation-anyway/>
- Wei, C. & Liu, W. (2019) Coming out in Mainland China: A national survey of LGBTQ students, *Journal of LGBT Youth*, 16:2, 192-219, DOI: 10.1080/19361653.2019.1565795
- Wu, J. (2008) From "Long Yang" and "Dui Shi" to Tongzhi: Homosexuality in China, *Journal of Gay & Lesbian Psychotherapy*, 7:1-2, 117-143, DOI: 10.1300/J236v07n01
- UNDP, USAID (2014). *Being LGBT in Asia: Thailand Country Report*. Bangkok. (2014). *Being LGBT in Asia: The Philippines Country Report*. Bangkok.
- Zsila, A., & Demetrovics, Z. (2017). The boys' love phenomenon: A literature review. *Journal Of Popular Romance Studies*, 6, 2-3. Retrieved from
- <http://www.jprstudiesest.dreamhosters.com/wp-content/uploads/2017/04/TBLP.4.2017.pdf>



Edutainment: Pagsusuri sa mga Gampanin, Katangian, Arketipo, at Simbolismong Nakikita sa Pagganap ng mga Piling Karakter na Selyula sa Japanese Anime Na “Cells at Work!”

Hinano T. Miyao, Abbygale C. Pinca, at Anna Patricia V. Gerong
Assumption College San Lorenzo, Makati City

Abstrak: Ang “Cells at Work!” ay isang Japanese edutainment na ipinalabas noong 2018. Binigyang-diin sa seryeng ito ang mga pangyayari sa loob ng katawan ng tao na may 32.7 trilyon na selyula. Kaugnay nito, nilayon ng pag-aaral na masuri ang gampanin at katangian ng mga selyulang ipinakita sa palabas at maunawaan ang papel ng arketipo at simbolismo sa paglalahad ng impormasyon hinggil dito. Sa isinagawang pag-aaral, pinili ang mga karakter na selyula na neutrophils, red blood cells, platelets, helper t cells, at macrophages. Bumuo ng coding sheet na kinapapalooban ng mga kaalaman hinggil sa selyula, enneagram, at ginamit ang semiyotika ni Barthes sa pagsusuri sa mga simbolismo. Batay sa pagsusuri, natuklasan ng mga mananaliksik ang mga sumusunod: ang nangibabaw na gampanin ng mga piling karakter ay ang pagdependa sa katawan ng mga neutrophils, pagiging circulating cells ng RBCs, pagiging maikli ng haba ng buhay ng platelets, pagbuo ng istrategiya laban sa sakit ng helper t cells, at ang pagiging bahagi ng macrophages sa lahat ng connective tissues at organs ng katawan. Samantala, ang nangibabaw na arketipo ay ang “the Eight”, “the Six”, at “the One”. Ang nangibabaw naman na simbolo ay ang karakter na selyula. Naipakita rito ang pagiging tagapagtanggol, “first-responders”, tagasuporta sa iba’t ibang gampanin ng katawan, tagapag-ayos sa katawan, pamumuno, paggabay, at proteksyon sa ibang selyula. Sa kabuoan, makikita na nagkaroon ng malaking papel ang representasyon sa mga piling selyula upang mas maunawaan ang gampanin nito sa ating katawan.

Susing salita: Cells At Work!; selyula; gampanin; enneagram; semiyolohiya

1. INTRODUKSIYON

1. 1. Rasyonale

Ayon kay Peters (2013), may malaking puwang sa pagitan ng siyensya at midya. Kabilang dito ang hindi maayos na komunikasyon at ang kakulangan sa pag-unawa ng mga siyentista at midya sa paraan ng paglalahad nito. Upang mapunan ang puwang sa suliranin, nagkaroon ng *edutainment media*. Ang *edutainment* ay isang *jargon* sa *audiovisual arts* kung saan pinagsasama ang mga salitang “education” at “entertainment” (Brodesco, 2011; Merriam-Webster, w.p.). Ginagamit ito sa anumang midyum ng *entertainment* na idinisenyo upang maging *educational* sa mga manonood. Sa ganitong pamamaraan, ang mga *scientific communicators* ay nakapagbabahagi ng mga impormasyon sa mas malawak na madla sa isang katanggap-tanggap na paraan (Martinez-Conde & Macknick, 2017). Kaugnay nito, ang paggamit at paglaganap ng mga *edutainment* ay nagbibigay ng oportunidad upang mas maintindihan ang mga dating kumplikadong konsepto sa isang simpleng paraan (Li & Orthia, 2015; Palmer, Dixon, & Archer, 2016).

1. 2. Kaugnay na Literatura at Pag-aaral

Isang halimbawa ng *edutainment media* ay ang *anime* na “Cells at Work!”. It’y nagbigay-daan sa mga manonood upang maobserbahan ang mga pangyayari sa selyula sa loob ng katawan ng tao. Bagama’t may ibang *edutainment media* na nagtatalakay sa pagganap ng mga selyula, katulad ng “Ozzy & Drix” na kilala rin bilang “Osmosis Jones”, mayroong mga natatanging pagkakaiba sa mga tuntunin ng (a) bilang ng mga selyulang binibigyang-pokus, (b) ang paraan ng paggamit ng mga *audiovisual* istrategiya, at, ang pinakamahalaga, (c) ang antas ng kaalamang inilalahad tungkol sa mga selyula (Airey, 2020; Dr. Hope’s Sick Notes, 2018, 00:00:44 – 00:08:42; IMDb, 2001; IMDb, 2002, Matt Doyle Media, 2020; Ozzy & Drix, 2012; Valdez, 2018).

Ipinaliliwanag lamang ng naunang inilahad na ang *cell biology* ay isang larangan ng biyolohiya kung saan pinag-aaralan ang istruktura, pagganap, ugali, at gampanin ng mga selyula sa katawan ng tao at iba pang organismo sa mga prosesong nakapagpapatili ng buhay (Alberts atbp., 2013; Tortora, Funke, & Case, 2018). Dahil ang disiplinang ito ay nakatuon sa pag-unawa ng mga munting proseso sa katawan, nakatutulong ang pagsusuri nito



upang matukoy ang iba't ibang gampanin ng katawan (Bouton, 2018; McDermott & Roediger, 2018).

1. 3. Mga Layunin ng Pag-aaral

Nakatuon ang pananaliksik na ito sa pagsusuri sa pagganap ng mga piling karakter sa *anime* na "Cells at Work!".

Nais ng mga mananaliksik na masagot ang mga sumusunod na katanungan:

1. Paano ipinakita ang mga gampanin at katangian ng mga piling karakter na selyula sa *anime*?
2. Ano ang mga nangingibabaw na arketipo na itinampok sa mga piling karakter?
3. Ano ang mga simbolismong nangingibabaw sa mga piling karakter?

2. METODOLOHIYA

2. 1. Disenyo ng Pag-aaral

Ang pananaliksik na ito ay gumamit ng kwalitatibong metodo at isinaalang-alang sa pagsusuri ang *descriptive case content analysis*. Ito'y sapagkat nakatuon ang pag-aaral sa pagsusuri at paglalarawan sa mga selyulang itinampok sa *anime*. Tinangka nitong maunawaan ang pagganap ng mga selyula batay sa mga gampanin, arketipo, at simbolismong ipinakita sa Japanese *anime* na "Cells at Work!"

2. 2. Yunit ng Analisis ng mga Datos

Ang palabas na ito ay may labintatlong (13) *episode*, at isang (1) *season* na ipinalabas noong 2018 (Airey, 2020). Ang pag-aaral ay nakatuon sa pagsusuri sa gampanin, katangian arketipo at simbolismong makikita sa pagganap ng mga selyula mula sa mga *episode* sa unang season ng "Cells at Work!" Bukod dito, pinili ng mga mananaliksik ang mga *episode* at eksenang nagpapakita ng mga gampanin o katangian ng limang (5) uri ng selyula sa *anime*. Sa kabuoan, mayroong 13 na *episode* at 132 na eksenang sinuri sa pananaliksik.

2. 3. Instrumento ng Pag-aaral

Gumamit ng instrumentong *coding sheet* sa isinagawang pag-aaral. Sa paggawa nito, ginamit ng mga mananaliksik ang iba't ibang batayan. Sa gampanin at katangian ng mga piling selyula, ang mga naging batayan ay ang mga sumusunod: "Basic immunology: functions and disorders of the immune system" (Abbas, Lichtman, & Pillai, 2016), "Cytotoxic t lymphocytes" (Bakshi, Cox, & Zajac, 2014), "Karp's cell and molecular biology: concepts and experiments (Eighth edition)" (Karp, Iwasa, & Marshall, 2016), "Becker's world of the cell (Eighth edition)" (Hardin,

Bertoni, Kleinsmith, & Becker, 2012), "Blood groups and red cell antigens" (Dean, 2005), "Medical Cell Biology (Third Edition)" (Goodman, 2008), at "Harrison's principles to internal medicine" (Jameson atbp., 2018).

Para sa arketipo, ang ginamit na batayan ay ang *enneagram* nina Riso at Hudson mula sa librong "Personality Types: Using the Enneagram for Self-Discovery" (1996). Sa kabilang dako, ang mga ginamit bilang batayan sa pagbuo ng simbolismo ay ang "Semiotics: the basics" ni Chandler (2017), "Elements of semiology" ni Barthes (1968), at "isang semyolohikal na pagsusuri... sa... Gloc-9" ni Demeterio (2013).

3. RESULTA

3. 1. Ang mga Gampanin at Katangian ng mga Selyula na Nakita sa Palabas

Batay sa isinagawang pagsusuri, ang nangingibabaw na gampanin sa mga karakter na neutrophil ay ang pagdidipensa nito sa katawan mula sa impeksyon at sakit (Alberts atbp., 2013, p. 1300; Jameson atbp., 2018, pp. 991-992). Ito ay ipinakita ng 28 beses sa kabuoang eksena. Ang katangiang nangingibabaw naman ay ang pagiging *white blood cells* nito na makikita sa 27 eksena (Goodman, 2008, p. 96).

Sa mga karakter na RBCs, ang nangingibabaw na katangian ay ang pagkakaroon nito ng *hemoglobin* (Alberts atbp., 2013, p. 1274; Jameson atbp., 2018, p. 1831). Ito ay ipinakita ng 59 na beses. Ipinakita naman ang gampanin nito bilang *circulating cells* ng 54 na beses at tagapagdala ng pagkain at nutrisyon sa katawan ng 48 na beses (Hardin atbp., 2012, p. 227; Karp atbp., 2016, p. 167).

Sa mga platelets naman, ang nangingibabaw na katangian ay ang maikling haba ng buhay ng mga selyulang ito (Dean, 2005, p. 10; LeBrasseur, 2007, p. 1; LeBois & Josefsson, 2016, p. 2). Ito ay makikita ng 18 beses mula sa kabuoang 36 na eksena. Ang gampanin naman na ipinakita ay ang pagiging responsable nito sa pagpapatigil ng pagdurugo na makikita ng 16 na beses (Dean, 2005, p. 10; Karp, atbp., 2016, p. 263).

Sa helper t cell, ang nangingibabaw na gampanin ay ang kakayahan nitong bumuo ng mga istrategya laban sa mga *pathogens* na makikita ng 9 na beses (Karp atbp., 2016, p. 707). Isa rin sa mga nangingibabaw nitong katangian ay ang kakayahang mag-*recruit* sa ibang *immune cells* patungo sa lugar ng impeksyon na makikita ng 5 beses sa palabas (Abbas atbp., 2016, p. 16; Karp atbp., 2016, p. 707).

Sa mga macrophages, ang nangingibabaw na katangian ay ang pagiging bahagi nito sa lahat ng



connective tissues at organs ng katawan (Abbas atbp., 2016, p. 23) na makikita ng 12 beses.

3. 2. Mga Arketipong Nakikita batay sa Enneagram nina Riso at Hudson

Samantala, sinuri din ang mga nangingibabaw na arketipo batay sa enneagram nina Riso at Hudson (1988). Ito’y nahahati sa tatlong triad: (a.) Feeling Triad: “*the Helper*”, “*the Motivator*”, at “*the Individualist*”, (b.) Thinking Triad: “*the Investigator*”, “*the Loyalist*”, at “*the Enthusiast*”; (c.) Instinctive Triad: “*the Leader*”, “*the Peacemaker*”, at “*the Reformer*”. Ginamit ang arketipo sapagkat ang mga karakter na selyula, sa pabalas, ay itinuturing na tao na gumaganap sa kanilang tungkulin sa loob ng katawan.

Ang nangingibabaw na arketipo sa neutrophil ay *the Leader* (“*the Eight*”). Ito ay nauuri sa *instinctive triad* sa *enneagram*.

Ang nangingibabaw naman na arketipo sa mga RBCs ay *the Loyalist* (“*the Six*”) na nauuri sa *thinking triad* (Riso & Hudson, 1996).

Mula naman sa 18 na eksenang sinuri sa mga karakter na platelets, ang pinakanangibabaw na arketipo ay *the Loyalist* (“*the Six*”), at ito ay nauuri sa *thinking triad*. Bukod dito, *the Leader* (“*the Eight*”) at *the Peacemaker* (“*the Nine*”) ay ang mga arketipo na pangalawang nangingibabaw sa karakter na ito.

Ang arketipo na ipinakita naman sa mga karakter na helper t cells ay ang *the Reformer* (“*the One*”) mula sa *instinctive triad*.

Panghuli ang nangingibabaw na arketipo sa mga karakter na macrophages ay ang *the Loyalist* (“*the Six*”). Ito ay nauuri sa *thinking triad*, at ang ugali ng mga taong naririto ay ang pagbibigay-diin sa lohika at pag-iisip.

3. 3. Pagsusuri sa mga Simbolismo sa Palabas gamit ang Semyotika ni Barthes

Matapos masuri ang katangian, gampanin at arketipong nangibabaw, binigyang-pansin din ang simbolismong makikita sa pamamagitan ng semyolohikal na pagsusuri. Mula rito, nagabayan ang proseso ng pag-aanalisa sa mga simbolismo sa mga prinsipiyo at ideya ni Barthes. Sa gayon, isinagawa ng mga mananaliksik ang pagsusuri sa mga piling karakter batay sa pagkakasunud-sunod: neutrophils, red blood cells, platelets, helper t cells, at macrophages. Ang mga piling karakter mismo ang nagsilbing mga *sign* at ibinatay ang mga *signifier* at *signified* alinsunod sa inilahad ni Barthes hinggil sa semyotika.

(1) <i>Sign</i>	
(2) <i>Signifier</i>	(3) <i>Signified</i>

Ang *sign* na neutrophil ay nagpakita ng *signifier* na kulay puti (pisikal na katangian ng selyula). Makikita na ang mga neutrophil ay madalas na nauunang dumarating tuwing mayroong *antigen* sa katawan, kaya ito ay nagkaroon ng *signified* na “kaligtasan” at “*first responders*”. Bukod dito, may iilang pagkakataon na makikita ang mga neutrophils na nagtatanggol sa ibang mga selyula mula sa mga *antigens*. Dahil dito, may nabuong *signified* sa mga neutrophil bilang senyas ng “proteksyon” mula sa mga sakit o *antigens* na maaaring magpahamak sa ibang selyula.

Ang *sign* naman na RBCs ay may *signifier* na pagiging kulay pula. Ito ay ang pangunahing kulay sa pang karaniwang uniporme ng mga karakter. Ang uniporme na ito ay bumubuo ng *signified* na “may *hemoglobin*” sapagkat ang protinang ito ang nagbibigay ng pulang kulay sa selyula. Ito ay nakita sa *episode 11* ng *anime* noong naglalakad ang mga RBCs, na hindi nakaayos ang kanilang uniporme, sa *capillaries* na nasa ilalim ng matinding init. Sumusuporta ito sa *signifier* dahil naapektuhan ng init ang *binding strength* ng hemoglobin at ito ang nagiging dahilan sa pagkawala ng pulang kulay sa itsura ng mga tauhan (Stadler atbp., 2008, p. 1).

Mula rito, ang mga karakter na ito ay may *signified* na “suporta” dahil sila ay makikitang nagdadala ng mga mahahalagang bagay, katulad ng *O₂ gas* at *nutrients*, sa iba’t ibang bahagi ng katawan. Bukod dito, makikita ang mga selyulang ito na nagdadala ng *O₂ gas* sa *alveoli* upang magkaroon ng *gas exchange* at matanggal ang *CO₂* sa katawan. Ito ay mas ipinakita sa *episode 8*.

Makikita naman na may iba’t ibang *signifier* ang mga karakter na platelets sa palabas na ito. Ayon sa pagsusuri, ang *signifier* na naging katugon sa kabuoan ng mga piling eksena ay ang pagsusuot ng malaking *light blue* na *t-shirt*. Ito ay bumuo sa *mental concept* ng pagiging bata. Bukod dito, madalas na makikita ang mga karakter na ito malapit sa mga lugar na may sira. Dito, madalas makikita ang *caution tape*. Mula rito, nabuo ang *signified* na “konstruksyon” at “pag-aayos ng istruktura” sa mga selyulang ito.

Makikita naman ang mga *signifier* sa karakter na helper t cell: ang puting uniporme, *computer*, tsaa, salamin, at ang *PA system*. Mula rito, ang mga nabuong *signified* ay ang “pamumuno”, “kaalaman”, “katalinuhan”, “gabay”, at “matiwasyay”.



Panghuli, ang mga *signifier* ng karakter na macrophage ay ang “kulay puti”, “malaking kutsilyo”, “kulay pula”, at ang “*briefcase*”. Ang kulay puti ay nangangahulugang “kaligtasan”. Samantala, ang kulay pula, ang *briefcase* at ang malaking kutsilyo ay bumubuo sa *signified* na “proteksyon”. Ang malaking kutsilyo ay nangangahulugan din bilang “lakas” sapagkat ito ay napakalaki at nakapapatay ng iilang mga birus. Panghuli, ang *signifier* na “*two-way radio*” ay nangangahulugang “komunikasyon” sapagkat ito’y ginamit sa *episode 3* sa pagbibigay ng impormasyon hinggil sa *influenza virus*.

4. DISKUSYON

4. 1. Lagom

Ipinakita sa mga resultang ipinahayag na nagkaroon ng malaking papel ang pagsasalaysay at ang mga istratohiyang ginamit sa palabas na “Cells At Work!” Madalas makikita ang mga gampanin ng mga selyula ay lumabas sa mga aksyon at tugon ng mga karakter sa mga nangyayari sa bawat eksena. Mula rito, tila mayroong mga “*situational metaphors*” kung saan ipinakikita ang mga gampanin at katangian ng mga selyulang ito (Bouton, 2018; Dahlstrom, 2010; Dahlstrom, 2014). Bukod dito, ang pagpapakita sa mga prosesong nauugnay sa mga piling selyula ay ginawa sa pagpapakita sa loob ng katawan na tila lipunan na may sariling batas at istrakturang panlipunan.

Ito ay sumasang-ayon sa isang kaugnay na literatura tungkol sa *cell biology edutainment*. Ayon kay Brodesco (2011):

“*audiovisuals can make us see the inner body using two different narrative tools: 1) the shrinkage of people...into the body; 2) the immersion into a body through an insider look...*”

Sa “Cells At Work!”, ginamit ang naratibong istratohiya kung saan ipinakita ang katawan ng tao bilang isang *fictional world* gamit ang mga tauhan. Naipakita rin dito na napahalaga ang kolaborasyon ng *humanities*, partikular ang literatura at midya, sa paglalahad ng mga siyentipikong impormasyon sa isang mas maiintindihang paraan (Fischer, Tobi, & Ronteltap, 2011; Fitzsimons & Killen, 2013; Weinmann atbp., 2013).

Samantala, ang pinakanangingibabaw na arketipo sa limang (5) sinuri na karakter ay *the Eight* (“*the Leader*”). Ayon kay Riso at Hudson (1996), ang karaniwang ugali ng taong nauuri rito ay ang pagiging *self-assertive*, may paniniwala sa sarili, mapamaraan at marubdob na indibidwal. Ito ay naaangkop sa mga piling karakter na selyula sa katawan dahil ang mga selyulang ito ay tumutulong sa katawan upang magampanan nito nang mabuti ang kanilang mga gampanin at, sa gayon, tayo ay mabubuhay nang walang masamang pakiramdam.

Mula sa mga simbolong ginamit, ang nangibabaw na *sign* ay ang mga karakter mismo. Bukod dito, ang nangibabaw na *signifier* ay ang kulay ng damit nito at ang nangibabaw na *signified* ay madalas may kinalaman sa gampanin ng selyula sa katawan. Isang dahilan kung bakit naging epektibo ang paggamit ng simbolismo sa palabas ay ang *visual nature* ng biyolohiya. Ayon kay Jenkinson at McGill (2012) “*biology is an inherently visual domain*”. Karamihan sa mga kasalukuyang kaalaman sa biyolohiya ay nanggaling sa mga *imaging technologies* katulad ng *x-ray*, *crystallography* at *electron microscopy*. Naiiwasan nito ang iba’t ibang antas ng *abstraction* sa pag-unawa, at posibleng makatulong sa pagtugon sa puwang na ito dahil ang mga simbolismo ay may literal na kahulugan na mauugnay sa abstrak na konsepto upang mas maintindihan at maalala ito (Fink, 2015; Serpente, 2011; Todorova atbp., 2015).

4. 2. Kongklusyon

Sa kabuoan, ipinakita ang mga gampanin ng mga piling selyula sa *anime* na “Cells At Work!” sa paraan ng pagsasalaysay sa bawat *episodes* ng palabas at sa paggamit ng mga simbolismo sa mga karakter upang mailahad ang mga mahahalagang kaalaman hinggil sa *cell biology*. Mula rito, makikita na napakahalaga ang paggamit ng mga naratibong teknik sa siyentipikong *edutainment media*, partikular ang arketipo at simbolismo.

Sa palabas, makikita na naging epektibo ang representasyon ng mga selyula bilang tao sapagkat mas maiintindihan ng mga manonood ang mga gampanin ng mga selyula upang mapanatili ang *homeostasis* ng katawan. Bilang resulta, ito ay maaaring makalutas sa puwang sa *scientific communication* sa pagitan ng mga eksperto at ang pangkalahatang publiko.

5. PASASALAMAT

Taus-pusong pasasalamat ang aking ipinaaabot sa mga sumusunod na indibidwal dahil sa mahahalagang tulong, kontribusyon at suporta tungo sa matagumpay na reyalisasyon ng pananaliksik na papel na ito:

1. Maraming salamat po kina Bb. Abbygale C. Pinca at Bb. Anna Patricia V. Gerong (Pagbasa at Pagsusuri ng Iba’t Ibang Teksto Tungo sa Pananaliksik at Research in Daily Life 1), mga masisigang namang dalubguro, na gumabay sa akin sa tamang hakbangin sa pagsulat at paggawa ng isang pananaliksik na papel, lalung-lalo na kay Bb. Pinca sa kanyang walang hanggang paniniwala at pagsuporta sa akin bilang mananaliksik, at sa paksang pinag-aaralan sa papel na ito,



- Kay G. Ronald Allan L. Cruz ng Unibersidad ng Ateneo de Manila, sa pagpapakita ng interes sa pag-aaral na ito bilang *validator*,
 - Sa aking mga matatalik na kaibigan na sina Anna Patricia D. Esguerra ng Humanities and Social Sciences Strand sa Unibersidad ng Santo Tomas at Maria Concepcion M. Franco ng Assumption College San Lonrezo sa kanilang lubos na pagtulong sa pagwawasto ng aking gramatika at sa pagsasalina sa iilang bahagi ng unang yugto ng pagsasaliksik upang maipahayag nang buong sukat ang mga natuklasan sa pag-aaral na ito,
 - Sa mabubuti kong kaibigan na sina Ada Marie G. Saldaña, Maria Concepcion M. Franco, at Raniah L. Selva, sa kanilang taos-pusong pagsuporta upang maging matagumpay ang aking pagtatanghal sa kongresong ito, at sa kanilang paniniwala sa aking pangarap na mailatha ang pag-aaral na ito,
 - Kina Denise Ashley L. Ko at Gavin Christian M. De Vera ng Unibersidad ng Ateneo de Manila sa paglalaan ng panahon upang matulungan nila ako sa paghahanap ng mga *validators*, lalung-lalo na kay Ashley Ko na naniwala sa aking kakayahan at hindi sumuko sa pagtulong upang makamit ko ang tagumpay,
 - Sa mga awtor, *editor* at mga mananaliksik ng mga akdang aking pinaghanguan ng mahahalagang impormasyong ginamit sa pagbuo ng papel na ito,
 - Sa aking pamilya sa pag-unawa at pagsuporta sa mga gabi na inalay ko para sa pananaliksik na ito, at higit sa lahat,
 - Sa Poong Maykapal, sa Kanyang patuloy na paggabay, pagpapalakas, at pagbibigay ng mga taong naging biyaya sa aking buhay habang binubuo ang pananaliksik na ito.
- Muli, maraming-maraming salamat po at ipinagdarasal ko po na ang pag-aaral na ito ay makaaambag sa mga diskusyon katulad nito sa larangan ng agham, at makatutulong ito sa pagpapalawak, at sa pagpapatibay sa larangan ng pananaliksik sa ating bansa.
- ## 6. MGA SANGGUNIAN
- Abbas, A., Lichtman, A., & Pillai, S. (5th ed). (2016). Basic immunology: functions and disorders of the immune system. Missouri: Elsevier Inc.
- Airey, J. (2020). 'Cells At Work!' season 1 review. <https://studiojakemedia.com/2020/04/04/cells-at-work-season-1-review/>
- Alberts, B., Bray, D., Hopkins, K., Johnson, A., Lewis, J., Raff, M., ...Walter, P. (4th Ed.). (2013). Essential cell biology. United States of America: Garland Science.
- Bakshi, R. K., Cox, M. A., & Zajac, A. J. (2014). Cytotoxic t lymphocytes. Encyclopedia of Medical Immunology Springer: New York, 332-2.
- Barthes, R. (Unang Amerikanong Ed.). (1968). Elements of semiology (A. Lavers & C. Smith Trans.). New York: Hill and Wang.
- Bouton, M. (2018). Conditioning and learning: observational learning. In A. Butler (Ed.), General Psychology: Fall 2018, 108-115. Orlando: DEF Publishers.
- Brodesco, A. (2011). I've got you under my skin: narratives of the inner body in cinema and television. Nuncius, 26(1), 201-221. <https://doi.org/10.1163/182539111X569829>
- Chandler, D. (3rd Ed.). (2017). Semiotics: the basics. New York: Routledge.
- Dahlstrom, M. (2010). The role of causality in information acceptance in narratives: an example from science communication. Communication Research, 37(6), 857-875. <https://doi.org/10.1177/0093650210362683>
- Dahlstrom, M. (2014). Using narratives and storytelling to communicate science with nonexpert audiences. Proceedings of the National Academy of Sciences, 111(4), 13614-13620. <https://doi.org/10.1073/pnas.1320645111>
- Dean, L. (2005). Blood cells and red cell antigens [PDF]. Maryland: National Center for Biotechnology Information (NCBI). https://www.ncbi.nlm.nih.gov/books/NBK2261/pdf/Bookshelf_NBK2261.pdf
- Demeterio, F. (2013). Isang semyolohikal na pagsusuri sa mga kontradiksiyong nakapaloob sa panlipunang kritisismo ni Gloc-9. Malay, 26 (1), 17-35.
- Fink, E. L. (2015). Symbolic interactionism. The International Encyclopedia of Interpersonal Communication, 1-13. <https://doi.org/10.1002/9781118540190.wbeic266>
- Fischer, A., Tobi, H., & Ronteltap, A. (2011). When natural met social: a review of collaboration between the natural and social sciences. Interdisciplinary Science Reviews, 36(4), 341-358. <https://doi.org/10.1179/030801811x13160755918688>
- Fitzsimons, C., & Killen, J. (2013). How science can help solve the enneagram's credibility problem. The Enneagram Journal, 6 (1), 1-22. https://ieaninepoints.com/wp-content/uploads/2019/01/2013-IEA-Journal_CJ-Fitzsimons_and_Jack-Killen.pdf
- Hardin, J., Bertoni, G., Kleinsmith, L., Becker, W. (8th Ed.). (2012). Becker's world of the cell. New York: Pearson Benjamin Cummings.
- Dr. Hope's Sick Notes. (2018). Real doctor reacts to Cells At Work! anime review [Video]. YouTube. Kinuha noong ika-14 ng Pebrero, 2020, mula sa <https://www.youtube.com/watch?v=pnvgQCavmkM>
- IMDb. (2001). Osmosis Jones. <https://www.imdb.com/title/tt0181739/>
- IMDb. (2002). Ozzy & Drix. <https://www.imdb.com/title/tt0306371/>
- Jameson, J. S., Fauci, A.S., Kasper, D. L., Hauser, S. L., Longo, D. L., Loscalzo, J. (2018). Harrison's principles of internal medicine. New York: McGraw-Hill Education.
- Jenkinson, J., & McGill, G. (2012). Visualizing protein interactions and dynamics: evolving a visual language for molecular animation. Life Sciences Education, 11, 103-110. <https://doi.org/10.1187/cbe.11-08-0071>



- Karp, G., Iwasa, J., & Marshall, W. (8th Ed.). (2016). Karp's cell and molecular biology. New Jersey: John Wiley & Sons, Inc.
- Lani, J. (2011). The Riso-Hudson Enneagram Type Indicator (RHETI) [PDF File]. <https://pdfs.semanticscholar.org/bb6c/1322149bd9a87c274cd631e883f281cf059e.pdf>
- LeBois, M., & Josefsson, E. (2016). Regulation of platelet lifespan by apoptosis. *Platelets*. <https://doi.org/10.3109/09537104.2016.1161739>
- LeBrasseur, N. (2007). Platelets' preset lifespan. *The Journal of Cell Biology*, 177(2), 186-187. <https://doi.org/10.1083/jcb.1772rr5>
- Li, Rashel & Orthia, L. A. (2015). Communicating the nature of science through The Big Bang Theory: evidence from a focus group study. *International Journal of Science Education*. <https://doi.org/10.1080/21548455.2015.1020906>
- Martinez-Conde, S., & Macknik, S. (2017). Opinion: finding the plot in science storytelling in hopes of enhancing science communication. *Proceedings of the National Academy of Sciences*, 114(31), 8127-8129. <https://doi.org/10.1073/pnas.1711790114>
- Matt Doyle Media. (2020). Cells at work [anime review]. Kinuha noong ika-19 ng Agosto, 2020, mula sa <https://mattdoylemedia.com/2020/01/28/cells-at-work-anime-review>
- McDermott, K., & Roediger, H. (2018). Memory (encoding, storage, retrieval). In A. Butler (Ed.), *General psychology* (Fall 2018), 117-140. Milwaukee: Diener Education Fund.
- Merriam-Webster. (w.p.). Definition of edutainment. Kinuha noong ika-19 ng Agosto, 2020, mula sa <https://www.merriam-webster.com/dictionary/edutainment>
- Ozzy & Drix. (2012). Home with Hector [Video File]. <https://www.dailymotion.com/video/xx3d3q?playlist=x2gds4>
- Palmer, D., Dixon, J., & Archer, J. (2016). Using situational interest to enhance individual interest and science-related behaviours. *Research in Science Education*, 47(4), 731-753. <https://doi.org/10.1007/s11165-016-9526-x>
- Peters, H. (2013). Gap between science and media revisited: Scientists as public communicators. *Proceedings of the National Academy of Sciences*, 110(3), 14102-14109. <https://doi.org/10.1073/pnas.1212745110>
- Riso, D., & Hudson, R. (Naiwastong Ed.). (1996). *Personality types: using the enneagram for self-discovery*. New York: Houghton Mifflin Company.
- Stadler, A. M., Digel, I., Artmann, G. M., Embs, J. P., Zaccari, G., & Büldt, G. (2008). Hemoglobin dynamics in red blood cells: correlation to body temperature. *Biophysical journal*, 95(11), 5449-5461. <https://doi.org/10.1529/biophysj.108.138040>
- Serpente, N. (2011). Cells from icons to symbols: molecularizing cell biology in the 1980s. *Studies in history and philosophy of science part C: studies in history and philosophy of biological and biomedical sciences*, 42(4), 403-411. <https://doi.org/10.1016/j.shpsc.2011.07.006>
- Todorova, S., Dimitrov, T., Ivanova, I., Muradov, H., Spiridonova, R., Nedelcheva, R., Petrova, D. (2015, Oktubre). Innovations in teaching and learning microbiology – painting with pigment organisms. *Papel na ipinakita sa biotechnologies and food technologies, Angel Kanchev Unibersidad ng Ruse*.
- Tortora, G., Funke, B., & Case, C. (13th ed.). (2018). *Microbiology: an introduction*. United States of America: Pearson Education, Inc.
- Valdez, N. (2018). Scientists praise 'Cells at Work!' for its entertaining accuracy. Kinuha noong ika-14 ng Pebrero, 2020, mula sa <https://comicbook.com/anime/2018/08/26/cells-at-work-cancer-episode-accuracy-praised-anime/>
- Weinmann, C., Löb, C., MattheiB, T., & Vorderer, P. (2013). Approaching science by watching TV: what do entertainment programs contribute to viewers' competence in genetic engineering? *Educational Media International*, 50(3), 149-161. <https://doi.org/10.1080/09523987.2013.839152>



Women on the Margins: A Case Study on The National Federation of Peasant Women in the Philippines (AMIHAN)

Francesca Therese A. Arnedo, Janelle Marie P. Baro and Emilene
Maxine F. Fadri

De La Salle University Integrated School, Biñan City, Laguna

Christian P. Gopez, Research Adviser
De La Salle University Integrated School, Manila

Abstract: Throughout the years, the agricultural sector continues to face challenges such as land entitlement, unequal wages, and human rights violations. Along with these are gender-based issues that further intensify the difficulties faced by farmers, particularly peasant women. With the establishment of organizations like The National Federation of Peasant Women in the Philippines (AMIHAN), these challenges are given attention as it aids in upholding rights and providing voices for peasant women. This study explored the motivations behind AMIHAN's establishment, its nature and how it differs from other women's organizations, and how the organization amplifies voices and provides alternative platforms to peasant women in the Philippines. Two leaders and five peasant women were interviewed via the online conferencing platforms, Zoom and Messenger. Three main findings were inferred: 1) peasant women are united and empowered by the organization's advocacies, 2) peasant women face both sector-specific and non-sector-specific issues, and 3) peasant women are given a platform to voice their issues through the organization. With the help of AMIHAN, the gap left out by the broad goals of women's movements are addressed, and the inequality and oppression faced by peasant women are tackled.

Key Words: AMIHAN; peasant women; women's organization; alternative platform

1. INTRODUCTION

The role of women's organizations has changed over time. According to Hega et al. (2017), "the dynamic women's movement in the Philippines is the product of a long history of struggle and participation in various historical conjunctures." These changes in the nature of women's movements were products of various socioeconomic and political conditions. Over the years, women's organizations have proven themselves vital for their role in empowering women (Cornwall, 2016). In the Philippines, organizations like The General Assembly Binding Women for Reforms, Integrity, Equality, Leadership, and Action (GABRIELA), Malayang Kilusan ng Bagong Kababaihan (MAKIBAKA), and Katipunan ng Kababaihan para sa Kalayaan (KALAYAAN) have played a vital role in the national democratic struggle that aims to achieve broader goals for the benefit of all women and marginalized sectors. However, the generality of their goals overlooks underlying sector-specific issues, and these issues are tackled by certain organizations. According to Hur (2012), "feminist hegemonies are not just scattered in detached and divisive ways but are instead scattered in multidimensional spaces having its ultimate aim,

the struggle against women's oppression in both private and public domain," implying that there is no division in the overall movement.

The National Federation of Peasant Women in the Philippines (AMIHAN) is an example of an organization that tackles sector-specific issues. Established on October 26, 1986, AMIHAN was formed as a response to the need to give a collective voice to peasant women through advocating for their rights and liberties. The organization's unity allows the issues faced by women in the agricultural sector to be heard. As Penunia (2011) states, organizations like this are significant for the "empowerment, poverty alleviation, and advancement of farmers and the rural poor."

The agricultural sector stands as one of the Philippines' primary sources of income, taking up 22.2% of the country's labor force (Philippine Statistics Authority, 2019). Despite this, it still stands as one of the most contested sectors in terms of the fight against poverty, workers' rights, and equality. Aside from this, issues like red-tagging and harassment also exist and are aggravated by various policies implemented. In the Philippines, the number of literature tackling sector-specific women's



organizations and their struggles are also limited, resulting in these challenges to be overlooked. In addition, gender-based discrimination further intensifies the challenges faced by women in this sector. As Anonuevo (2000) notes, “the long history of colonialism has embedded a patriarchal culture among Filipinos.” This subverts the efforts enacted by women, hindering them from becoming emancipated from the existing stereotypes and preventing them from achieving their full potential. Though both men and women contribute to the industry, women’s “livelihoods, rights, and socio-economic status are weakly asserted compared to men” (Chandra et al., 2017).

Given the current situation of peasant women in the country, AMIHAN still stands firm in fighting for their rights and advocacies. With 35 chapters nationwide and almost 14,000 active members, the organization has provided peasant women assistance in addressing the challenges they encounter within the sector.

Thus, this research explored the motivating factors that led to its establishment and described its nature and difference from other women’s organizations towards establishing how the organization amplifies the voices of peasant women in the Philippines. Studying organizations such as AMIHAN helps in tackling the diversity of feminist hegemonies, which also helps in advancing, strengthening, and solidifying the organization’s advocacies.

2. METHODOLOGY

This research employed a qualitative case study design to describe the nature of AMIHAN as a women’s organization and to discover how they amplify the voices and provide alternative platforms for peasant women in the Philippines. The key informants of the study were the leaders and members of the organization. Snowball sampling was used in identifying five informants from the following chapters: Cavite (1), Bicol (1), Camarines Sur (1), and Panay (2), while the National Chairwoman and Secretary-General were invited to participate in the study.

Most of the members have been part of the organization for four or more years except for the Cavite member because their chapter was only established in December 2020. Because of the ongoing issues faced by the agricultural sector, the researchers decided to assign codes to each participant. The following are the assigned codes for the respondents:

- [L1] Chairwoman
- [L2] Secretary-General
- [M1] Cavite
- [M2] Bicol
- [M3] Camarines Sur

[M4] Panay A

[M5] Panay B

wherein [L] stands for the leaders of the organization, and [M] stands for the members.

Due to the pandemic, the interviews were conducted virtually through Zoom and Messenger, wherein two sets of semi-structured questionnaires were utilized. This took place in a span of three months. In analyzing the data, the researchers applied components of Braun and Clarke’s thematic analysis (2015), which was defined to be a way of finding themes or patterns within the data. After analyzing the data, the answers were narrowed down into three main themes that revolve around AMIHAN as a unifier, as an agent for social and agricultural change, and as an alternative voice to peasant women. Proper research ethics were observed by administering informed consent forms to the respondents beforehand to ensure that they understand the study’s goal and direction. Moreover, the respondents had an option whether they prefer using their names or an alias to preserve their anonymity.

3. RESULTS AND DISCUSSION

3.1 AMIHAN as an organization that unites and empowers peasant women

The establishment of AMIHAN strengthens the unity among peasant women, empowers them to break free from traditional gender norms, and take action against the oppression they face. According to L2, the symbolism of the word AMIHAN is based on the attributes of the northeasterly wind, which she associated with women:

“Hindi naman malamya [ang kababaihan]. Kababaihan ‘yan, na kapag nagkaisa, at kapag napagbuklod-buklod para dun sa isang layunin, ay parang hangin ‘yan na kasing lakas din ng bagyo. At ang bagyo na ‘yan ay pwedeng manira o sirain ‘yung sistemang umiiral.”

M1 shared similar sentiments by saying, “Ang AMIHAN, lalo na dito sa amin, sinisikap namin yung sama-samang pagkilos na pinagkakaisahan ng lahat,” showing how the organization and its members value unified strength as a means to pursue their goals.

AMIHAN started with only five provincial/municipal-level organizations scattered across the Luzon, Visayas, and Mindanao regions. L2 said, “nakita [nung mga organizations na nabuo na] yung kahalagahan na mabuo ito sa pambansang antas para yung kanilang isyu sa lokal ay madala ito sa national level bilang sentro ng komunikasyon.”

AMIHAN founders saw the importance of establishing an organization that is headed and participated in by women. It was discussed that in



organizations where men and women farmers co-exist, women are given roles influenced by traditional gender stereotypes such as serving or cooking. According to L2, “Nakita ‘yung kaibahan. Pag kasama kasi ang mga kababaihan sa organisasyon ng kalalakihan, parang hindi talaga nae-exercise freely ‘yung kanilang mga gustong ilahad.” She further emphasized that, “higit sa lahat, bilang kababaihang magsasaka [importante] ‘yung pagkilala dun sa malaking kontribusyon nila sa ekonomiya at sa ating agrikultura.” M1 also said that women are usually stereotyped as weak, incapable, and submissive; however, according to them, “sa amin, ang hamon ay papaano namin—marami pang palalakasin—o paano pa namin o-organisahin ‘yung kagaya naming mga kababaihang magbubukid na tingnan ang sarili na hindi mababa at walang lakas,” showing how they strive to overcome society’s gender stereotypes.

In a bigger perspective, the leaders have mentioned that despite policies on agrarian reform, loss of land still poses a major problem for farmers. The continued fight over land ownership impacts peasant women both economically and psychosocially as this is a primary way for them to sustain their families. This is why there is a need for them to continue fighting and organizing for the rights of their lands, as it will also affect their personal lives. This exhibits how AMIHAN is able to create a significant impact not only for women but on the agricultural sector itself.

3.2 Women’s struggles through the lens of peasant women

Peasant women experience various challenges ranging from sector-specific to non-sector-specific issues. In terms of sector-specific matters, legislations such as the Rice Liberalization Law are said to pose a major threat for all farmers. It was stated that this law had caused a collapse in production and loss of income for the agricultural sector due to traders preferring cheaper imports. On top of having to compete with rice imports and prices, farmers also have to compete with corporations and state forces over land ownership. One of the longest-standing struggles in the agricultural sector is loss of land through land reclamation or land use conversion, which forces them to abandon their territory. In addition, military force is often used to coerce peasant workers to flee the premises. As explained by M4, “ginagamit nila ito para mabigyan ng pabor ang gusto nilang ipatayo.” This is not the only case of militarization that exists in the agricultural sector. When it comes to non-sector-specific matters, peasant women also experience harassment which has led to severe outcomes. These harassments, according to M2, is further heightened due to policies that encourage state violence such as Memorandum Order

32 (an order specific to certain places that reinforces the AFP and PNP against lawless violence), Executive Order 70 (institutionalizing the NTF-ELCAC), and Republic Act No. 11497 (Anti-Terror Law). Among the aforementioned policies, the Anti-Terror Law intensifies red-tagging, which has resulted in various cases of harassment, killing, and threatening the livelihood of peasant women in the country. As M1 explained, “kapag ipinagtatanggol mo na [ang karapatan mo], eh NPA ka na.” The gravity of this policy was further emphasized by L2 stating that, “ang nakakatakot dito, pagkatapos maredtag, pwede ka nang patayin.” These challenges impede the hard work of peasant women because it refuses them the freedom to their own livelihood as well as their basic human rights. However, with the help of AMIHAN, these women find a way to address these struggles.

3.3 AMIHAN as a women’s organization that combats inequality and oppression against agricultural workers

Challenges within the sector are dealt with through the efforts of both the leaders and members of AMIHAN. The leaders stated that the problems existing within the agricultural sector are given more focus because the advocacies carried out by the organization are directed specifically towards it. Generally, the agricultural sector is already facing a myriad of problems, and within the sector itself, there are specific issues faced by women. L2 stated, “[bilang babae], partikular na bahagi kami ng sektor ng magsasaka na kung saan ‘yung isyu ng mga magsasaka ay problema din namin,” and “sa isyu ng ating sektor may specific issues na kinakaharap ang mga kababaihan kaugnay dito.” According to a concept paper released on their official website, they spearheaded the #DefendPeasantWomen campaign, which urged citizens to “join in the filing of letter of appeal to investigate the rights abuses victimizing peasant women at the Commission on Human Rights and other government agencies” (AMIHAN, 2021). They also mentioned that unlike other women organizations, AMIHAN is critical of the policies implemented by the government that directly affect them. As noted by L2, they offer resolutions to policies that affect their sector by mentioning, “ikina-campaign namin [yung mga advocacy] at naglo-lobby kami sa congress at saka sa senate, gano’n din sa mga LGUs. Mga lobby para do’n sa mga ano ‘yung mga effect nito at ano ‘yung alternatives na isinusulong ng aming organisasyon.” These resolutions range from demilitarizing the countryside to policy implementations such as pre-irrigation laws. Members also engage in activities and projects that strengthen and promote AMIHAN’s advocacies. Based



on the interviews, some of the activities they take part in include educating people about the state of peasant women as well as holding donation drives of relief goods for them. In addition, they also participate in protests that help inform the masses about the current situation of peasant women in the country and to push forward their call for change in solidarity with other organizations.

All of these are fueled by the tenacity and determination of peasant women in standing up not only for their rights but the rights of others as well. As mentioned by M4, “gusto namin na makatulong sa mga kaparehas naming magsasaka, lalo na ang mga babaeng magsasaka.” Ultimately, the establishment of AMIHAN has definitely been vital for both peasant women and the agricultural sector in their pursuit of equality and freedom from oppression.

4. CONCLUSIONS

Peasant women endure age-old challenges inside and outside the agricultural sector. These challenges, along with their drive to uplift peasant women in the agricultural sector, are the primary motivations behind AMIHAN’s establishment. Inherently, what sets AMIHAN apart from other women’s organizations is that they focus on sector-specific issues that directly affect their economic and psychosocial wellness. By taking into consideration the situation and experiences of peasant women, and applying them to their projects and advocacies, AMIHAN is able to unify peasant women in fighting against inequality and oppression within the agricultural sector. By pushing forward their call for change, not only does the organization amplify their voices, but it also acts as a platform for these women to contribute to the bigger counter-hegemony that struggles for women’s rights and their place in society.

5. ACKNOWLEDGMENT

The authors would like to thank the HUMSS faculty and the De La Salle University Integrated School for making this research possible. The completion of this undertaking would not have been possible if not for the assistance and support of teachers, classmates, family, and friends. Specifically, the authors would like to thank the following people who graciously offered their insights and support for the paper: Mr. Patrick Lorilla, Ms. Eiren Buenviaje, Ms. Megan Yap, Ms. Sofia Cariño, Mr. Philip Bartolabac, Mr. Gabriel Cruz, Mr. Luigi Estrella, and the entirety of the HUMSS 12A section. The authors would also like to extend their deepest gratitude to their research mentors, Mr. Jeyson T. Taza and Mr. Janeson M. Miranda, and their research adviser, Mr. Christian Gopez, for their unwavering patience and guidance during the study’s duration.

Higit sa lahat, taos-pusong pinasasalamatang mga mananaliksik ang AMIHAN at ang lahat ng mga nakilahok sa pananaliksik na ito. Ang pag-aaral na ito ay inaalay namin sa lahat ng mga kababaihan sa kanayunan at sa kanilang mga layunin para sa kababaihan at sa sektor ng agrikultura.

6. REFERENCES

- AMIHAN. (2021). #DefendPeasantWomen against rights abuses. <https://amihanwomen.org/2021/04/28/defendpeasantwomen-against-rights-abuses/>.
- Anonuevo, C. A. Q. (2000). An overview of the gender situation in the Philippines. Friedrich-Ebert-Stiftung Philippine Office.
- Chandra, A., et al. (2017). Gendered vulnerabilities of smallholder farmers to climate change in conflict-prone areas: A case study from Mindanao, Philippines. *Journal of Rural Studies*, 50, 45-59.
- Clarke, V., Braun, V., & Hayfield, N. (2015). Thematic analysis. *Qualitative psychology: A practical guide to research methods*, 222-248.
- Cornwall, A. (2016). Women's Empowerment: What Works?. *Journal of International Development*, 28(3), 342-359. <https://doi.org/10.1002/jid.3210>.
- Hega, M.D., Alphora, V.C., & Evangelista, M.S. (2017). Feminism and the Women's Movement in the Philippines. Friedrich Eberto Stiftung.
- Hur, S.W. (2012). Dynamics of Women’s Movements and Feminist Counter-Hegemony Against Neoliberal-Patriarchal Democracy in the Philippines. eds. Hee-Yeon Cho, Andrew Area and Song-Woo Hur, *From Unity to Multiplicities: Social Movement Transformation and Democratization in Asia*, Selangor: SIRD, 215-38.
- Penunia, E.A. (2011). The role of farmers’ organizations in empowering and promoting the leadership of rural women. Accra, Ghana: UN Women, FAO, IFAD and WFP.
- Philippine Statistics Authority. (2019). Employment Situation in January 2019. psa.gov.ph/statistics/survey/labor-and-employment/labor-force-survey/title/Employment%20Situation%20in%20January%202019.



Paghilom: A Narrative Analysis of the Healing testimonials of The Mary, Mediatrix of All Grace Devotees in Facebook Groups

John Paolo L. Mañalac and Kenan Febry S. Perez
De La Salle University Integrated School, Biñan City, Laguna

Gerald L. Latayan, *Research Adviser*
De La Salle University Integrated School, Biñan City, Laguna

Abstract: Popular Religiosity is deeply embedded in the Philippine culture, especially devotions to arguably the most venerated figure in the Philippines, the Virgin Mary. The Our Lady of Mediatrix of all Grace is just one of the several figures of Mary, highly revered and honored by the people in Lipa, Batangas. With the advent of COVID19, testimonies of healing attributed to this patroness have emerged in Facebook devotional groups, an attestation to the faith of her devotees. The aim of this research is to look into the narrative categories of these testimonies through the use of Narrative Analysis. The data garnered are 10 video testimonies from the devotees of Our Lady Mediatrix of All Grace, posted at selected Facebook devotional groups. In the end, the researchers have generated five narrative categories that are present within the healing testimonies, namely: *Pagsubok*, *Pagkilala*, *Pamamanata*, *Paggaling*, and *Pagpapatotoo* to these miraculous experiences. These narrative categories will not just add to the existing body of literature about the devotion to Our Lady of Mediatrix of All Grace and the message of hope within these testimonies, but also Popular Religiosity within the Philippine context.

Key Words: popular religiosity; faith; healing; testimonies; devotional groups

1. INTRODUCTION

Popular Religiosity equates with the religion of the common people and how they live in accordance with their religion's teachings (Marzal, 2007). Contextually, Popular Religiosity plays a vital role in the lives of Filipinos because it is seen as a way to connect with the divine being in which one believes in. For Filipino Catholics, this connection allowed them to ask God, Jesus, and Mary, among many other divine beings/saints for miraculous favors, such as healing for specific illnesses. Popular religiosity is deeply grounded in culture, which may, in effect, be practiced by a specific community, as seen in fiestas, novenas, and processions.

Marian Piety is an external custom towards Mary and is the most popular form of popular religiosity in the Philippines (Sapitula, 2014). In the Philippines, Marian Piety relies on the ability to make religious practice relevant to the emerging needs and aspirations of the Filipino people (Sapitula, 2014). With great love and affection for Mary, the Philippines has been labeled as Pueblo Amante de Maria, which essentially translates to people who are in love with Mary. Furthermore, Marianism is a religious system highlighting the devotion to Mary, and is one of the defining characteristics of the Philippines. Even in the early stages of Christianity, Filipinos were already

devoted to her, paving the way to the birth of the numerous Marian titles present today: Mother of Perpetual Help, Our Lady of Peñafrancia, Our Lady of Manaoag, Our Lady of Mount Carmel, Nuestra Señora de Namacpacan, Nuestra Señora del Carmen de San Sebastian, Our Lady of La Naval de Manila, and Virgen de Caysasay among many others.

The devotion to Mary, Mediatrix of All Grace of Lipa, Batangas is one of the many Marian devotions in the Philippines. It started when a lady allegedly appeared to a nun at the Carmelite convent of Lipa, Batangas, the seer Teresita "Teresing" Castillio, on August 18, 1948. The lady gave odd requests to Teresita, such as washing and kissing the feet of the convent's Mother Prioress and drinking the water used to wash the feet, and consumption of grass every three in the afternoon. These requests were seen as prior conditions to prepare Teresita for the path ahead, an act of faith and humility, a symbol of obedience. Shower of rose petals started occurring. First was inside the convent, after Teresita was fixing her bed. The shower of rose petals is a common print of supernatural phenomena in Marian apparitions. Then, the Lipa shower of petals occurred outside the Carmelite convent, with high-ranking church officials and thousands of people witnessing and experiencing it, making the story much more compelling. The lady



also asked Teresita to pray for the clergy and the conversion of sinners and instructed her to erect a shrine of prayer. These are also common in Marian apparitions. Lastly, the lady asked Teresita to name their convent “Our Lady’s Carmel” and a statue of her be made the way Teresita sees her revealing herself and be called “Mary, Mediatrix of All Grace”. This image of Mary became popular with images of it being replicated and distributed not only in the Philippines but also abroad. In the end, the authorities of the Roman Catholic Church declared the mystifying events that occurred in Lipa as “Without supernatural intervention,” including the alleged shower of petals. Religious clerics and nuns were forbidden to talk about the event, and evidence about it was destroyed, making the studies regarding it limited and controversial (Tinio, 2006).

1.1. Research Objectives

This research aims to analyze the healing testimonials of Mary, Mediatrix of All Grace devotees in Facebook devotional groups. Specifically, it aims to:

- a. describe the narrative categories that the devotees from the select Mary, Mediatrix of All Grace devotional groups have shared in their testimonials;
- b. retell the devotees’ healing testimonies from the select Mary, Mediatrix of All Grace devotional
- c. groups using the constructed narrative categories.

2. METHODOLOGY

The nature of this research is Qualitative, involving the collection and analysis of data that is not based on numbers (Bhandari, 2020). Qualitative research has numerous approaches, such as *Narrative Analysis*. Narrative Analysis in Qualitative research is used to understand how people construct stories and narratives from their own experiences (Riessman, 1993). In this study, the researchers used Narrative Analysis as a lens to look into the healing testimonies of the devotees of Mary, Mediatrix of All Grace of Lipa, Batangas. There are 10 videos of healing testimonies in total that follow the said criteria: It must be posted from one of the selected Facebook devotional groups of the said patroness, and the testimony must credit Mary, Mediatrix of All Grace of Lipa, Batangas to the said healing. This study used the *Inductive* method of coding for conducting the Narrative Analysis; this means that the narratives emerged from the raw data itself.

3. RESULTS AND SUMMARY

The journey towards healing of these devotees started with a struggle that pushed them to search for miracles. It is their sense of hope and faith in Mary, Mediatrix of All Grace that drives them to

this search. The researchers have identified five narrative categories within the 10 healing testimonies, namely: Pagsubok, Pagkilala, Pamamanata, Paggaling, and Pagpapatotoo. These five narrative categories are part of the overall journey of healing.

3.1 Pagsubok

Having a Pagsubok is inevitable primarily because to say that one is under a challenging circumstance is outrightly subjective. Elaborately, people from all walks of life experience their own Pagsubok, ranging from financial constraints to though one can afford, there is no cure for one’s disease. Essentially, Pagsubok may be experienced by anyone. The story of each devotee, who the researchers refer to as the source of their data, contains their own Pagsubok or Struggles. On a denotative aspect, Struggle defined is an event or situation which is highly unfavorable and affects a person negatively. Struggle may come in different forms. For example, in their testimonies, the devotees acquired numerous diseases and health complications, like in what Devotee1 said:

“After one particularly **heavy bout of coughing and breathlessness**, when I was brought to the Medical City yet again, the bomb dropped. I got admitted on my husband’s birthday on September 5, and from then on, all I knew seemed to go downhill. They have found a tumor in my thymus gland, and after a battery of tests, **I was diagnosed with having stage four (4) Thymic Carcinoma.**”

Moreover, Devotee2 said:

“In August of this year, I experienced painful body itches, it was so irritable and so itchy that I felt so restless and so sad to the point of **depression** because of this body itch, and I couldn’t sleep at night.”

At its core, Pagsubok in their testimonials also encompasses the anchored experiences within these medical complications and/or illnesses. Some of them felt hopeless given the situation they are in. Others felt the need to be stronger and fight the challenges ahead of them, while others looked for signs from what they deem as a divine being, a sign that there is still hope regardless of the circumstances. It is in one’s Pagsubok that urges the person to seek divine intervention when all rational means fail.

3.2 Pagkilala

In their state of hopelessness and the lack of options to be healed, the devotees and/or their family members find ways apart from medical guidance to overcome their Pagsubok. Some, though they believe in God, do not ask him for help because their faith is not as strong, but when they are faced with a situation where there is no cure to one’s sickness, which may



eventually result in one's death, they resort to it because, at the end of the day, there is nothing to lose. Pagkilala, in this context, refers to the way in which the devotees have encountered the means of healing and/or the holy being through various manifestations, such as pamphlets, hearing from a family member, or stumbling upon a post on Facebook post among many others. In the healing testimony of Devotee4, she stated that she knew about Mary, Mediatrix of All Grace and her miracles through her mother and friends:

“I was also thankful when my friends, Dra. Hilda Alaba and Dr. Joel Estrada, came to visit me together with Fr. Aklon, who I met for the first time. They were so happy and surprised when they saw that being strong devotees of Mama Mary of Mediatrix to see that I had a black and white picture, Circa 1948 of Mama Mary which was given to me by my mother, Fe, who hailed from Tanawan Batangas at my bedside table.”

In the healing testimony of Devotee5, it was through her youngest child's reminder that she encountered the means of healing:

“Sabi ng aking anak na bunso: “mommy, ang Carmel, hindi mo pa po napupuntahan.” Kasi naandoon nga yung pagkakami'y tapos ng misa, kami ay nagrorosario sa harap ng Our Lady Mediatrix of All Grace.”

3.3. Pamamanata

After encountering the means of healing (Pagkilala), it is now time for them to act out their faith. Faith per se is one's belief in a divine or holy being. Pamamanata, on the other hand, is the action to achieve one's desire to, for example, be healed. Notably, Pagkilala and Pamamanata go hand in hand. After encountering the means of healing, if one has already been aware of the means for one to be healed, the next step is *mamanata* or to act upon one's faith. According to Ramos (2014), *Panata* is how the people manifest their faith in the holy being so that their pleas and desires might be heard and granted. Examples of Pamamanata are praying of novenas, recitation of litanies, praying of the rosary, processions, and more. In the healing testimony of Devotee7, she said:

“All I could do was give him sips of hydrating salts dissolved in **water that had been consecrated to mama Mary Mediatrix**. I gave him one sip at a time; very slowly, praying, he would not vomit.”

On the other hand, Devotee10 said:

“**Ayon, sabi ko lord baguhin mo naman po ang buhay ko, mama mary tulungan niyo po ako**, nakikiusap po ako sa inyo ako po ay hirap na hirap na sa tagal ng pinagdaraan ang sakit na ito, may butas po ang bladder ko.”

The faith of these people in Mary, Mediatrix of All Grace and the various means of healing attributed to her are what pushed them to their Pamamanata.

3.4 Paggaling

After constant requests for their desires to be granted, it is in this phase that the devotees get healed through the intercession of Our Lady Mary Mediatrix of All Grace. This is notably considered the heart of the healing testimonies of the devotees primarily because they have been freed from and have overcome their Pagsubok, then receiving their Paggaling. Healed, by definition, means that one has become healthy again, coming from the state of being sick. In this context, the devotees who have testified have received their healing when they have done something in order to receive such healing. Some of the devotees have simply prayed for healing, while some drank consecrated water. In the testimony of Devotee9, she experienced complications with her health and was expected to undergo a particular surgery. She prayed to Mary, Mediatrix of All Grace for healing so that she may not have to undergo the said surgery. Subsequently, just what she prayed for, she said:

“The lump disappeared. 23 years have passed, (the) lump has not returned.”

Paggaling in their healing testimonies highlights the divine intervention of Mary, Mediatrix of All Grace as a response to their Pamamanata. Their experience with Paggaling gave them a sense of gratitude towards Mary, Mediatrix of All Grace, and they saw it as a sign that, indeed, miracles are true. The Paggaling of these devotees also gave them a new perspective in life that indeed problems are inevitable. But now that they have experienced the miracles of Mary, Mediatrix of All Grace, they know that they are not alone facing these challenges, that their faith in her will help them get through anything.

3.5 Pagpapatotoo

Pagpapatotoo stems from one's Paggaling from the Pagsubok that they have experienced. Having been through one's own Pagsubok, then being healed through the intercession of Our Lady Mary, Mediatrix of All Grace, one has the urge to spread or share the 'grace' of Mary to others out of gratitude, whether it be to inspire people who are also under difficult circumstances or are experiencing health problems, or to verify that miracles are indeed real. It takes strong faith for one to attest to these miracles, and that strong faith is rooted in their personal experience of healing through Mary, Mediatrix of All Grace. Their Pagpapatotoo was also an act of gratitude towards Mary and God for healing them and saving them from the consequences of their Pagsubok. Notably, there are different ways to express one's



Pagpapatotoo or attestation to these miracles. In the case of Devotee1 she said:

“She allowed us to establish Marymount Westridge School, even with very limited funds, and now, she has continued to carry the school up to this day. Even if we are considered founders, my husband and I acknowledge that—human as we are—we could only have done so much. Ultimately, it is Mama Mary’s school, and she’s gotten us this far--that no matter what happens, she will always carry us, our school--in her school--through.”

Devotee3, on the other hand, said:

“I will claim that indeed Mama Mary appeared in Lipa” dahil nga po personally, ‘di ba ako ay naghahanap na iyan ay ma-aprubahan ng Vatican bago ko talagang paniwalaan 100% ang titulong ito ng Mahal na Ina ngunit sa pananalangin kong iyon, nasabi ko sa Panginoon, “Panginoon, I will personally claim that Mama Mary indeed, truly, appeared in Lipa kapag amin pong nalagpasan ito.”

The devotees’ Pagpapatotoo allows others who are also experiencing their own Pagsubok to receive the same hope as theirs, that their Pagpapatotoo may act as a way for others’ Pagkilala to Mary, Mediatrix of All Grace and Paggaling.

4. CONCLUSIONS

The researchers have constructed five narrative categories within the ten healing testimonies, namely: *Pagsubok*, *Pagkilala*, *Pamamanata*, *Paggaling*, and *Pagpapatotoo*. These narrative categories were the phases they underwent prior to them being healed. *Pagsubok* is the first category identified within the healing testimonies of the devotees. *Pagsubok*, in effect, made these devotees sought a way beyond the natural. They then encountered the message of healing (*Pagkilala*) that manifested in various forms. Having heard such means as to how one may be healed, the devotees then had the urge to utilize such means (*Pamamanata*), in high hopes that their condition would be cured. By exercising their faith, they were miraculously healed by Mary, Mediatrix of All Grace (*Paggaling*). This healing that they have experienced gave them a sense of strong faith and pushed them to testify (*Pagpapatotoo*) to the claimed miracles of Mary, Mediatrix of All Grace, in hopes of spreading her message to the people out of gratitude.

5. ACKNOWLEDGMENTS

First and foremost, we would like to thank Sir Jeyson and Sir Janeson, our Practical Research subject teachers, for teaching us the technicalities of research and helping us in all the phases of our paper’s revision. We would also like to thank Sir Leo

Vicentino, Sir Daniel Solidio, and Sir Errol Bantayan for giving their insightful comments on our research paper and helping us decide the necessary actions to make it better. We would also like to thank our family and classmates who have made the stressful times in making this research bearable, for constantly lending us their utmost support, whether it be emotionally, academically, and/or mentally. Moreover, we would like to extend our deepest gratitude to our research adviser, Sir Gerald Latayan, for guiding us all throughout this journey in making our research paper the best that it can be. Above all, we would like to thank God and Mary, our driving force to continue working on our paper despite the complexities, for everything that has happened and for these people who have helped us along the process. We certainly would not have done any of this had it not been for everyone who has helped us in making this possible.

6. REFERENCES

Bhandari, P. (2020, July 30). What is Qualitative Research?: Methods & Examples.

Calano, M. (2018). Ginhawa as Ethic of Panatà: Body Politics and the Devotion to the Black Nazarene. *Budhi*, 22(2), 43-74.

Carbayas, A. V., & Del Castillo, F. (2020). Christmas in the Philippines: Beyond Popular Religious Tradition. *Asia Pacific Journal of Multidisciplinary Research*, 8(2), 35-40.

Casabuena, Jennifer. (2015). Ideyolohiya at Utopia sa mga Liham sa Ina ng Laging Saklolo sa Baclaran. *Kritike: An Online Journal of Philosophy*. 9. 5-27. 10.25138/9.2.a.2.

Caulfield, J. (2020, August 14). How to Do Thematic Analysis: A Step-by-Step Guide & Examples.

De La Cruz, D. (2014). The Mass Miracle Public Religion in the Postwar Philippines. *Philippine Studies: Historical & Ethnographic Viewpoints*, 62(3/4), 425-444.

Demeterio III, F. P.. (2010). Mga Anyo at Antas ng Pag-asa na Nakapaloob sa mga Diskurso ng Kilusang El Shaddai. *MALAY*, 22(2).

Doyo, M. (2013, May 22). Mother of All Devotions - Positively Filipino: Online Magazine for Filipinos in the Diaspora.

Elesterio, F. (1989). Pre-Magellanic Religious Elements in Contemporary Filipino Culture. Manila: De La Salle University Press, pp 3-14.

Fortunado, A. (2020, January 09). Feast of the Black Nazarene draws millions to Manila's streets.

Furusawa, Y. (2013). Image and Identity: A Study on the Images of the Virgin Mary Clad in a Local Dress in the Philippines: Semantic Scholar.



- Ibones, N. C., Oliverio, J. S., Ondo, H. L., Tagpuno, H. C., & Inocian, R. B. (2016). Señor Santo Niño Devotees' Lived Experiences in a Fluvial Parade. *Asia Pacific Journal of Multidisciplinary Research*, 4(2), 180-187.
- Kahambing, J. (2019). Jean-Luc Marion's phenomenology of the Icon as an Apologia for Quiapo's Black Nazarene Traslación. *Prajñā Vihāra: Journal of Philosophy and Religion*, 20(2), 13-31.
- Lauderdale, J., & Phillippi, J. (2017, April 5). A Guide to Field Notes for Qualitative Research: Context and Conversation.
- Marzal, M. M. (2007, February 15). Popular Religiosity.
- Miller, J. (2015). Religion in the Philippines.
- Norris, J. M., & Nowell, L. S. (2017, October 2). Thematic Analysis: Striving to Meet the Trustworthiness Criteria.
- Oracion, E. G. (2013). The Sinulog Festival of Overseas Filipino Workers in Hong Kong: Meanings and Contexts. *Asian Anthropology*, 11(1), 107-127.
- Peracullo, J. (2020, April 18). The Virgin of the Vulnerable Lake: Catholic Engagement with Climate Change in the Philippines.
- Peterson, W. (2007). Holy Week in the "Heart of the Philippines": Spirituality, Theatre, and Community in Marinduque's Moriones Festival. *Asian Theatre Journal*, 24(2), 309-337.
- Pierse, G. (1991). Popular Religiosity: A Philippine Experience. *The Furrow*, 42(4), 232-236.
- Quitangon, Dominic. (2016). Social Influence and Stages of Faith Among Selected Voyageres of Penafrancia Chapter 1.
- Ramos, M.M. (2014). Ang Dalawang Anyo ng Subli: Laro at Panata.
- Russel, S. (2013). Christianity in the Philippines.
- Sapitula, M. (2014). Marian Piety and Modernity The Perpetual Help Devotion as Popular Religion in the Philippines. *Philippine Studies: Historical & Ethnographic Viewpoints*, 62(3/4), 399-424.
- Sarmiento, Philip Joseph. (2016). Attitude and Practices of Filipino Catholic Youth towards Mary, the Mother of God: Implications to Religious Education in the Philippines.
- The Global Catholic Population. (2020, August 20).
- Tinio, C. (2006, September). Omnium Gratiarum: A Theological Investigation on the Alleged 1948 Marian Apparition in Lipa Carmel.
- Vergote, A. (1982). Folk Catholicism: Its Significance, Value and Ambiguities. *Philippine Studies*, 30(1), 5-26.
- Villanueva, V. (2014). Pasubo bilang Panata: Pagbabalik, Pagtatagpo at Pagdiriwang sa Pook Pangkalinangan ng Pateros.
- What Is a Testimonial in Research? - Definition & Examples. (2015, June 27).
- Williams, B. (2015, June 29). Virtual Ethnography.
- Zaccaria, F. (2009, December 16). Participation and Beliefs in Popular Religiosity.



Calling in Call-out Culture: An Analysis on Call-out Culture and its influence on Filipino Twitter

Danielle P. Averion, Don Bernard Joseph P. Josef, Paul Ondre U. Nicolas
and Aaron Albert B. Parjan

De La Salle University Integrated School, Manila

Abstract: Call-out culture has become a questionable phenomenon in and out of Filipino Twitter due to the differing ideologies that participants have perpetuated, separating Filipino communities based on their standing on certain topics on the internet. The reason it has become dubious is due to the bullying that occurs because of the call-outs. Previous research had stated that call-outs have started shifting from being a tool used to oppose abuse into an accessory for building fame on the internet. The researchers used Foucauldian Discourse Analysis to analyze several replies, tweets, and quoted tweets from Filipinos on Twitter. The data was put under the lens of the synopticon theory and Althusser's concept of the Ideological State Apparatus. The analysis has led to the conclusion that there is an evident divide between Filipino communities, and, amid the discord with themes of colonialism and racism, public figures can use it as a device to manipulate the mindset of the masses.

Key Words: call-out; Twitter; Filipino entertainment; Filipino diaspora; controversy

1. INTRODUCTION

'Calling out' refers to the practice of using social media as a platform to criticize any action seen as morally reprehensible (Duchi, 2019, p. 2). The causes of call-outs are oppressive behavior to the breaking of generally accepted social norms but also used by digital activists to campaign for a more equal society. Although used for a good purpose, there is toxicity present. "Criticism enacted through "call-outs" is often perceived as needlessly ferocious and often disproportionate to the action criticized. In such cases, it is described as 'bullying', a particularly toxic consequence of calling out." (Duchi, 2019, p. 16). While some use it to make a name for themselves, call-outs started shifting in purpose. In which they used to be tools to fight against abuse, people began using it to build a name for themselves through call-outs (Duchi, 2019, p. 29).

This study aims to contribute a more academic perspective on call-out culture and its causes and effects on the Filipino landscape, adding more to the limited amount of studies on the topic. The researchers also aim to contribute more knowledge related to the potential ramifications of call-out culture on a global scale, providing a more in-depth understanding of call-out culture and its possible effects on society.

1.1. Conceptual Framework

1.1.1 Ideological State Apparatus

In Marxist theory, the State Apparatus includes the government, military, police, courts, prisons, and more. Together, these make up what Althusser calls Repressive State Apparatus (RSA), which uses violence in order to function. Althusser (1970) said this is to be differentiated from the Ideological State Apparatus (ISA), which functions ultimately without using violence despite having the same elements because it makes use of ideologies instead.

1.1.2 Synopticon

Mathiesen's (1997) form of surveillance, the "synopticon," which he developed from Foucault's interpretation of the panopticon, emphasizes a situation in which "the many" see "the few." He cites the notions of the consciousness industry (Enzenberger, 1974; Tuchman, 1981) and the culture industry (Horkheimer and Adorno, 1947;1969) wherein mass media influences the actions and behaviors of the public. Consequently, the public or better known as "the many" may then interact with "the few" using the "two-way medium" of the internet, such as through cyberactivism or call-out culture (Doyle, 2011; Tucker, 2018).

2. METHODOLOGY

To evaluate the ramifications of call-out culture and understand its effects, the researchers will use Discourse Analysis as a means of assessing

the phenomenon. Specifically, Foucauldian Discourse Analysis has been used as it can be utilized to understand a sequence of “representations, practices, and performances through which meanings, [knowledge, and subject positions] are produced, connected into networks, and legitimized” (Gregory, 2000, p. 180, as cited by Johnson & McLean, 2020). Furthermore, Discourse Analysis has proved to be the appropriate method of investigation in this circumstance as it allowed the researchers to identify the phenomenon based solely on online discussions and analyze its intricacies.

Along with this, the researchers have also applied Mathiesen’s theory on the synopticon. The researchers have utilized this to analyze a “call-out” tweet that has been interacted with multiple times by Filipino internet users. From this tweet, several of its quote retweets and replies have been gathered as well.

3. RESULTS AND DISCUSSION

3.1. *Kontraversies in Philippine Entertainment*

During Halloween in October of 2020, a Filipino band named MYMP held an online event wherein the band members dressed as prominent figures in music while performing their music. As the band works in the entertainment industry and is relatively popular, they are considered a part of Filipino Mainstream Entertainment (FME). Chin Alcantara, the band’s leader, dressed as Jimi Hendrix by wearing a colorful shirt and headband and wearing dark makeup. Individuals called him out through the comments section, with many telling him and others in the stream to “educate yourselves.” There were also mentions of the Black Lives Matter Movement, wherein Alcantara noted that it was “propaganda” and that instead of Black Lives Matter, he says that all lives should matter (Rappler, 2020). It should be noted that the researchers chose the MYMP situation as it was recent when it was chosen and analyzed (being only a month old) and is a relevant example of the normalization of racist acts by FME.

A recording of the livestream was posted on Twitter by user paz_ango (Figure 1), and the tweet garnered numerous engagements at 1.5K retweets, 13.4K quote tweets, 12.7K likes, and 590 replies. The notions of public space and surveillance are present here, with Twitter being the public space or arena in this situation where people have discourse and the concept of surveillance being exhibited by the traction attained by the post as people seem attentive and watchful over the actions of public figures.



Figure 1.

The issue became a discussion on the site after multiple users expressed their opinions on the racist views of Alcantara in the livestream. It shows that some users manifest certain ideologies (in this case, anti-racism) through knowledge and the use of that knowledge in critically calling out those who have made mistakes or contributed to the problem. This critical perspective can be attributed to how call-out culture has positively shaped the way users interact with injustices they see (Figures 2.1-2.3).



Figure 2.1



Figure 2.2

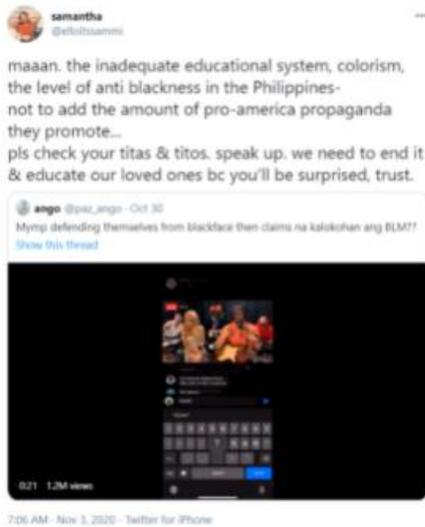

Figure 2.3

Meanwhile, there are also users who either vehemently oppose Alcantara’s beliefs by outright saying that they will boycott their music (Figures 3.1-3.2) or are ignorant to the racist actions that Alcantara has done by defending him or providing excuses for his actions (Figures 3.3-3.4).



Figure 3.3



Figure 3.4

Furthering the latter notion, many participants in the discourse have been shown to defend Chin Alcantara’s statements with some deriding differences in political beliefs (Figure 3.4), advocating his belief of the BLM movement being propaganda (Figure 3.1), and even saying how blackface is an issue foreign to Filipino culture and should not be taken in the Philippines (Figures 3.2 & 3.5). It should also be noted that some of these tweets have gained some traction, such as likes and retweets, showing the multitude of like-minded users. This shows the opposing views of some of the Filipino Twitter (FT) population, shattering any idea of unified opinion, as well as showing that there are users on FT with less progressive views. This expression of ideas and the division that ensues is a showcase of interpellation, which is the process wherein an individual embodies an ideology (Althusser, 1971). Its deepening showcases the manifestation of ideologies and their formation on opposing and conflicting sides.



Figure 3.1



Figure 3.2



Figure 3.4



Figure 3.5



Figure 4.1



Figure 4.2

Due to the divide in the views of FT and FME, a medium for call-out culture presents itself. The latter's continuous lack of vigilance in avoiding the depiction of controversial and harmful acts, like blackface, due to the lack of awareness and sensitivity essentially provides phenomena for the former to call-out.

3.2. *Pili-pino: The Divide between the Filipino Mainland and Diaspora*

The Filipino Diaspora are Filipinos who have migrated to other countries, and according to Merriam Webster, diaspora can be described as “people settled far from their ancestral homelands.” This includes the Fil-Ams and other Filipinos who have migrated to other nations. There are approximately 4.1 million Filipinos in the United States on the latest census, while the total population of America is estimated to be 330 million as of 23 January 2021 (Inquirer, 2019). This shows that approximately more than 1% of the population of America consists of Filipinos, compared to the population of the Philippines of 108 million (The World Bank, 2019), around 5% of the population is equivalent to the number of Filipinos in America, and they have a different lifestyle compared to the mainlanders.

The term “divide” was heavily used to describe the social awareness gap between FT and the entertainment industry concerning Chin Alcantara's blackface controversy. This issue arose due to some native Filipinos indirectly defending Alcantara by stating that blackface is not a problem in the Philippines as it is “not even something culturally related to the Philippines.” (Figure 4.1). This argument had a discursive influence on Fil-Ams to support it and impose this stance on Filipinos and call-out Ati-Atihan itself, leading an FT user to address the issue (Figure 4.2). Ati-Atihan is an annual festival to commemorate the Sto. Niño every third Sunday of January in the town of Kalibo, Aklan.

Despite their righteous intentions, the spread of the issue does not always lead to just informing others of the problem; it may also lead to instigating unnecessary commentary from other users. As previously discussed, Fil-Ams only joined the discussion shortly after the argument that Ati-Atihan contributed to blackface as well. The more it circulates among their separate network of fellow Fil-Ams, the more that a sense of interpellation starts developing among them. However, this is also the case for those not belonging to the Diaspora. Filipinos also fall victim to embodying a sense of obligation to continue to call out those that they deem “wrong” by their standards. This is attributed to Althusser's claim on interpellation in which he states that the “category ‘subject’ is created by the interpellation,” implying that the very reason call-outs exist is due to that sense of obligation (Cockshott, 2019).

Colonialism has changed how mainland Filipinos and Fil-Ams view each other, highlighting cultural and social friction between the two. This is due to the lingering influence of Western ideals and their imprint especially on the Fil-Ams on Twitter, which then allows them to present themselves as being a superior version of the Mainland Filipino who they deem as needing to be educated.

3.3. *Bagong MO: Ulterior Motives in Controversy*

Controversies, as discussed in the first two sections, are a quick way for a person or an issue to capture the attention of others. The concept of surveillance supports this as people observe and contribute toward the issue happening by expressing their views on it. Through the people's participation, the controversy and those involved in it suddenly become points of discussion, especially when carried out in a public space such as Twitter.

Theoretically, the chances of MYMP using the controversy as a publicity stunt are slim as it



brought more harm than good. However, the attention garnered from this can easily be manipulated by the perpetrators themselves. To quote Bibo Reyes, “these people do these things to get a reaction,” (Figure 5).



The page that FT users were calling out in Figures 6.1-6.3, Pilipinx Against Colonialism, has been rumored to be a satire page. The page is speculated to have been created by conservative Filipinos from the Philippines who aim to spark controversy between Mainland Filipinos and the Filipino Diaspora. As seen in the discussion in the previous section, its goal was successful.



Figure 6.1

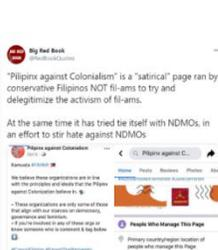

Figure 6.2



Figure 6.3

It is possible that public figures like MYMP and the rumored-to-be-satire Pilipinx Against Colonialism page use call-out culture and one of its by-products, controversy, as a means of manipulating the public mindset. This is supported by the potential ulterior motives of both groups, which are to gain publicity and cause friction between the Filipino Diaspora and the Mainland, respectively.

4. CONCLUSIONS

This study has focused on the phenomenon of call-out culture and its influence on Filipinos through the social media platform Twitter. Through the use of the ISA and the synopticon as a lens to analyze instances of call-out culture in FT (which mainly relate to themes of colonialism and racism), the researchers have made three notable discoveries: (1) There is a divide present between the FME and FT wherein the former proliferates racist ideas and concepts that the latter call out on; (2) Colonialism has affected how Filipinos (mainly Mainland Filipinos and the Filipino Diaspora) view each other; and (3) Amid the chaos, public figures can use call-out culture and, as a byproduct, controversy to manipulate the public mindset (especially FT) for their own agendas. This research has hoped to serve as the beginning of a meaningful discussion on the issue of call-out culture in Filipino social media and as a foundation for future researchers to build upon.

5. ACKNOWLEDGMENTS

We would like to thank our research advisor Ms. Ina Abuan, for guiding us throughout the research process and for being patient with us. We would also like to thank our adviser, Mr. Lambert Yancy Garganta, for being a constant source of moral support, and Mr. Christian Gopez, our research coordinator, for encouraging us to participate in the Research Congress and guiding us throughout our PRACRES journey in Grade 12.

6. REFERENCES

Althusser, L. (1971). Ideology and Ideological State Apparatuses (Notes towards an investigation). In Lenin and Philosophy and Other Essays (pp. 142-7 & 166-76). New York and London: Monthly Review Press.

Cockshott, P. (2019). Althusser's theory of ideology: Reversion to idealist mystery. Critique, 47(4), 551-583. doi:10.1080/03017605.2019.1678268

Doyle, A. (2011). Revisiting the synopticon: Reconsidering Mathiesen's 'The Viewer Society' in the age of Web 2.0. Theoretical Criminology,



15(3), 283–299.
<https://doi.org/10.1177/1362480610396645>

Duchi, F. (2019). The 'call-out culture' controversy: An identity-based cultural conflict. Retrieved from https://www.academia.edu/41128832/The_call_out_culture_controversy_An_identity_based_cultural_conflict

Inquirer.net U.S. Bureau. (2019, November 18). Filipino population in U.S. now nearly 4.1 million -- new Census data. Retrieved from <https://usa.inquirer.net/47388/filipino-population-in-u-s-grew-to-nearly-4-1-million-in-2018-new-census-data>

Johnson, M.N. & McLean, E. (2020). Discourse analysis. *International Encyclopedia of Human Geography*, 377-383. doi:10.1016/b978-0-08-102295-5.10814-5

Mathiesen, T. (1997). The Viewer Society: Michel Foucault's 'Panopticon' Revisited. *Theoretical Criminology*, 1(2), 215-234. Retrieved from <https://doi.org/10.1177/1362480697001002003>

Rappler. (2020). MYMP's Chin Alcantara slammed for performing in blackface, saying 'Black Lives Matter' a joke. Retrieved from <https://www.rappler.com/entertainment/music/mymp-chin-alcantara-draws-flak-blackface-saying-black-lives-matter-is-a-joke>

The World Bank. (2019). Population, total - Philippines. Retrieved January 24, 2021, from <https://data.worldbank.org/indicator/SP.POP.TOTL?locations=PH>

Tucker, B. (2018). 'That's Problematic': Tracing the Birth of Call-Out Culture. Retrieved from <https://ojs.leedsbeckett.ac.uk/index.php/SOC/article/view/4545>



Pagdalumat sa Sosyo-kultural at Pangkapaligirang Aspekto ng Uhayan Festival Gamit ang Likas-kayang Balangkas ng Pistang Pamana Pistang Naaayon

Philip Andre E. Bartolabac, Gabriel Daniel S. Cruz, Luigi O. Estrella
and Jeyson T. Taeza, Research Adviser
De La Salle University Integrated School, Biñan City, Laguna

Abstrak: Ang kapistahan ay pagdiriwang na nagsisilbing daluyan upang maipamalas ng isang pamayanan ang natatangi nitong tradisyon, paniniwala, produkto, at kultura sa pangkalahatan. Bagamat maraming mga pag-aaral na naisagawa ukol sa ugnayan ng pista at kultura, iilan pa lamang ang mga pag-aaral na nakatuon sa likas-kayang katangian ng mga kapistahan. Layunin ng pag-aaral na ito na dalumatin ang mga likas-kayang katangian ng Uhayan Festival sa Barangay Macabling, Sta. Rosa City, Laguna gamit ang balangkas ng Pistang Pamana at Pistang Naaayon. Kinalap ang mga datos sa pamamagitan ng katutubong pamamaraan na pakikipagkwentuhan sa mga susing tao na may kaugnayan sa implementasyon ng Uhayan Festival. Ang mga nakalap na datos na sumailalim sa coding at transkripsyon ay sinuri at isinatema batay sa mga aspekto ng likas-kayang balangkas ng Pistang Pamana at Pistang Naaayon: sosyal, kultural, at pangkapaligiran. Batay sa pag-aaral, ang mga programang nakapaloob sa Uhayan Festival ay nagtataguyod ng pagkakabuklod-buklod ng pamayanang Macabling. Sa kultural na aspekto, itinatampok ng Uhayan Festival ang iba't ibang gawain na nagsisilbing repleksyon ng Barangay Macabling bilang isang agrikultural na pamayanan. Ipinamalas ng Uhayan Festival ang kahalagahan ng pagtiyak sa pagiging likas-kaya ng isang kapistahan upang matagumpay at makabuluhan nitong magampanan ang mga layunin upang ito ay manatiling buhay at sustentable. Sa pangkalahatan, ipinakita ng pag-aaral na ito na ang pagtatampok ng kapistahan ay tumatawid sa kultural na aspekto tungo sa sosyal at pangkapaligirang aspekto. Mahalagang pag-aralan ang dinamiko ng pagkakaisa ng mga stakeholders ng kapistahan gayundin ang ginagawang hakbang sa pangangalaga ng kalikasan.

Mga Susing Salita: Uhayan Festival; likas-kaya; sosyal; kultural; pangkapaligiran

1. PANIMULA

Ang mga kapistahan ay maituturing na mahalagang bahagi ng kulturang Pilipino—ito ay nagiging daluyan upang maitampok ng isang pamayanan ang kanilang kultura, produkto, at ang kanilang mga paniniwala (Amtalao at Lartec, 2015). Malinaw ang ugnayan sa pagitan ng kapistahan at kultura ng isang pamayanan. Mahalagang pag-aralan ang mga pista sa pagdalumat ng kultura at integridad ng isang pamayanan upang higit pang maipakilala at maibahagi ang natatanging yaman na ito sa iba.

Bagamat marami ng mga pag-aaral na naisagawa na nagpapatunay sa matibay na ugnayan ng mga kapistahan sa Pilipinas, iilan pa lamang ang mga pananaliksik na dumalumat sa pagiging likas-kaya o sustentable ng mga kapistahan (Bandala, 2018). Ang mga pagtitipon tulad ng mga kapistahan ay kinakailangang umangkop sa pangangailangan ng pamayanan upang manatili itong buhay at magampanan ang mga layunin nito. Bukod sa layunin

nitong mapagbuklod ang isang pamayanan at ipakilala ang kultura nito, ang mga kapistahan ay maituturing ding paraan upang itaguyod ang turismo ng isang lugar. Ang *cultural tourism* ay isa sa mga pinakamabisang paraan upang maiangat ang ekonomiya ng isang lugar (Apostolakis & Viskadouraki, 2017). Ang pagtatampok ng mga pista ay nagbibigay-daan sa mga oportunidad para sa lokal na negosyo. Samakatuwid, habang ang mga kapistahan ay nakapagbibigay ng pagkakataon na lumago ang ekonomiya ng isang pamayanan, nagbibigay rin ito ng kakayahang ipreserba ang kultura nito (Quinn at Wilks, 2013). Ayon kay Quinn (2006), isa sa mga pangunahing rason sa pagdiriwang ng mga kapistahan ay ang benepisyo nito sa turismo at ekonomiya ng lugar.

Isa sa mga hamong dapat tugunan ng mga kapistahan ay mapanatili itong likas-kaya o sustentable. Upang mailarawan ang isang kapistahan na sustentable, may iba't ibang aspekto ang dapat

suriin. Isa sa mga aspektong ito ang kultural na aspekto ng kapistahan at maging ang epekto nito sa kalikasan. Ayon kay Wee (2015), upang maging likas-kaya ang isang kapistahan, kinakailangan ang estruktura at kultura ang magiging sentro ng kapistahan at may kabuluhan sa lugar na pinagdarausan ng kapistahan. Pangalawa, kailangan ng suporta at pakikilahok ng mga lokal sa pagtatampok ng kapistahan. Pangatlo, kinakailangan din na matiyak na positibo ang pangkalahatang karanasan ng mga turistang dadalo sa kapistahan. Isa pang batayan ng pagiging likas-kaya ng mga pista ay ang tinatawag na *Triple Bottom Line* (TBL) na nagmula kay Elkner noong taong 1987 (Tyrrell et al., 2013). Tinitingnan ng TBL ang aspekto ng kikitang pera, pati na rin ang sosyo-kultural at pangkapaligiran na epekto na dulot ng isang kapistahan sa mga mamamayan at mga turista.

Ang paksa ukol sa pagiging likas-kaya ng mga kapistahan ay naidokumento lamang gamit ang malalaki at pangunahing kapistahan sa Pilipinas. Mahalagang mapag-aralan din ang maliliit na kapistahan dahil katulad ng malalaking kapistahan, ang mga ito ay nakakatuong din sa pagkakabuklod-buklod ng mga lokal na residente at sa pagpapanatili ng kanilang kultura at pagkakakilanlan. Isa sa halimbawa nito ay ang Uhayan Festival sa Laguna. Ito ay isang taunang kapistahan na ginaganap tuwing ika-15 ng Mayo bilang pasasalamat at pagbibigay-dangal kay San Isidro Labrador. Ang kapistahan na ito ay ginugunita sa barangay ng Macabling na matatagpuan sa lungsod ng Santa Rosa, Laguna. Nagmula ang pangalan ng kapistahan sa salitang “uhay” na nangangahulugang tangkay kung saan umuusbong ang mga butil ng palay.

Nagsimulang ganapin ang Uhayan Festival noong 2008 na noon ay itinatapat sa kapanahunan ng pag-ani. Ang Uhayan Festival ay nabuo sapagkat nakita ng mga nanunungkulan noong panahon na iyon kung gaano kasagana ang ani at kung paano nakatuong ang pagsasaka sa unti-unting paglago ng barangay. Mula rito, nagpasya ang Sangguniang Barangay noong 2008 na lumikha ng ordinansa para sa taunang pagtatampok ng Uhayan Festival. Ang Uhayan Festival ay karaniwang ginugunita ng pista hanggang limang araw. Sa kapanahunan ng pista, nagkakaroon ng mga *variety shows, singing contests, dance contests*, at iba pa na may layuning itampok ang Macabling bilang isang agrikultural na pamayanan. Itinuturing ito bilang isang panahon kung saan ang bawat sitio at kapitbahayan ay nagkakilala, naghahanda, nagtutulungan, at nagkakaisa.

Sa kasalukuyan, wala pang pananaliksik ang naisasagawa upang dalumin ang Uhayan Festival. Bukod dito, wala pang anumang pag-aaral ang tumatalakay sa pagiging likas-kaya o sustentable ng

nasabing kapistahan. Ang pag-aaral na ito ay maaaring magsilbing batayan ng mga susunod pang pag-aaral tungkol sa Uhayan Festival. Bukod dito, ang pag-aaral din ay maaaring makatulong sa mga namamahala sa pagtatampok ng kapistahan upang makita ang iba’t ibang likas-kayang katangian ng Uhayan Festival tungo sa patuloy na pagpapabuti at pagpapayaman ng Uhayan Festival.

1.1 *Konseptwal na Balangkas*

Ginamit ng pag-aaral na ito ang balangkas na Pistang Pamana Pistang Naayon na nilikha ni Bandala (2018) upang dalumin ang mga likas-kayang katangian ng Uhayan Festival. Ang balangkas na ito ay angkop sa pananaliksik sapagkat ito ay nabuo mula sa danas ng mga kapistahan sa Pilipinas. Bukod dito, ang nasabing balangkas ay angkop din na gamitin sa mga maliliit na kapistahan tulad ng Uhayan Festival.



Figura 1. *Konseptwal na Balangkas ng Pag-aaral*

Gamit ang balangkas na ito, maingat na sinuri ng mga mananaliksik ang aspektong sosyo-kultural at pangkapaligirang ng Uhayan Festival sa pamamagitan ng pagsusuri sa mga pinakamahuhusay na stratehiya ng Uhayan Festival. Tinalakay sa sosyal na aspekto ang mga gawain na nagtataguyod ng pagkakabuklod-buklod ng mga lokal.

Tinalakay naman sa pangkultural na aspekto ang mga itinatampok sa Uhayan Festival na may mga kahulugan at kabuluhang pangkultura katulad ng mga sayaw, pagkain, at kasuotan ng mga kalahok sa Uhayan Festival. Sa pangkalahatan, ang aspektong ito sumasaklaw sa kakayahan ng Uhayan Festival na itampok at panatilihin ang agrikultural na pagpapahalaga ng Barangay Macabling.

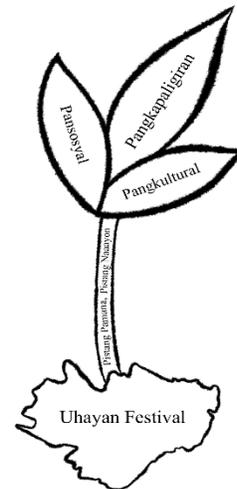

Sa ikatlong aspekto tinalakay ang pangkapoligirang aspekto na may kinalaman sa pagpapanatiling masinop at organisadong kalikasan tuwing pagdiriwang ng Uhayan Festival. Sakop din nito ang pagtiyak sa seguridad at kaligtasan ng kasangkot sa Uhayan Festival pati na rin ang mga bisita at turista.

1.2 Layunin ng Pag-aaral

Layunin ng pag-aaral na ito na dalumatin ang sosyo-kultural at pangkapoligirang aspekto ng Uhayan Festival sa Barangay Macabbling, Sta. Rosa City, Laguna gamit ang likas-kayang balangkas na Pistang Pamana Pistang Naayon. Layunin ng pag-aaral na tugunan ang mga sumusunod na tiyak na layunin:

1. suriin ang mga gawain sa Uhayan Festival na nagtataguyod ng pagkakaisa at pakikisangkot (Pansosyal na Aspekto) ng mga residente ng Barangay Macabbling;
2. tukuyin ang mga gawain sa Uhayan Festival na may kinalaman sa pagpapanatili at pagpapatibay ng kultura (Kultural na Aspekto) ng Barangay Macabbling; at
3. suriin ang mga estratehiyang ginagamit sa pangangasiwa ng kapaligiran (Pangkapoligirang Aspekto) sa tuwing idinaraos ang Uhayan Festival sa Barangay Macabbling

2. METODOLOHIYA

Dinalumat ng palarawang pag-aaral na ito ang likas-kayang katangian ng Uhayan Festival batay sa balangkas ng Pistang Pamana Pistang Naayon ni Bandala (2018). Ang mga datos sa papel na ito ay kinalap sa pamamagitan ng katutubong pamamaraan ng pakikipagkuwentuhan (informal conversation) at ginabayang talakayan (collective indigenous discussion) sa mga susing tao na may kaugnayan sa pagpapalano at pagpapatupad ng Uhayan Festival sa Barangay Macabbling, Sta. Rosa City, Laguna. Kabilang sa mga naging kasangkot sa pag-aaral ay ang mga dati at kasalukuyang kasapi o konsehal ng Sangguniang Barangay ng Macabbling, dati at kasalukuyang kasapi ng Sangguniang Kabataan ng Macabbling, at iba pang mahahalagang susing tao na may kinalaman sa pagpapalano at pagsasagawa ng Uhayan Festival.

Ang mga tanong at gabay sa talakayan ay sumailalim sa content validity upang matiyak na makakalap ang mga kinakailangang datos na tutugon sa layunin ng pag-aaral. Humingi ng pahintulot ang mga mananaliksik na irekord ang kabuon ng pakikipagkuwentuhan (informal conversation) at ginabayang talakayan (collective indigenous discussion). Ang mga nairekord na Zoom video meeting ay sumailalim sa proseso ng transkripsyon at

coding. Gamit ang likas-kayang balangkas ng Pistang Pamana Pistang Naayon, dinalumat at sinuri ang iba't ibang likas-kayang katangian ng Uhayan Festival batay sa Pansosyal na Aspekto, Pangkultural na Aspekto, at Pangkapoligirang Aspekto.

3. RESULTA AT PAGTALAKAY

Tinalakay sa bahaging ito ang iba't ibang gawain sa Uhayan Festival na nagpapakita sa pagiging likas-kaya o sustentable ng kapistahan. Hinati sa tatlo ang pagtalakay ng mga datos batay sa iba't ibang aspekto ng Pistang Pamana Pistang Naayon ni Bandala.

3.1 Pansosyal na Aspekto

Nakapaloob sa pagdiriwang ng Uhayan Festival ang sari-saring gawain at programa na nagtataguyod ng pagkakaisa ng mga mamamayan ng Barangay Macabbling. Sa pamamagitan nito ay naipamamalas ang pagkakabuklod-buklod ng mga buong pamayanan upang matagumpay na maitampok ang kapistahan.

Talahanayan 1. Mga Gawaing Nagpapakita ng Pansosyal na Aspekto ng Uhayan Festival

Pinakamahuhusay na Gawain	Gampanin sa Uhayan Festival
Dance Exhibition	Ito ang patunay sa kakayahan ng kapistahan na maging lunduyan ng pagkakaisa, sapagkat naipapamalas nito ang pagsasama at pagkakaisa ng mga kalahok mula sa paghahanda hanggang sa araw ng patimpalak. Ang programang ito ang isa sa mga rason kung bakit at paano nagkakaisa ang mga taga-Macabbling. Nabanggit ni Teodori at Lullof (1998) na ang pakikilahok sa mga kapistahan ay malaking kadahilanan sa pag-usbong ng pagkakaisa sa loob ng isang pamayanan.
Street Dance Competition ng Bawat Purok ng Barangay	Ipinahihwatig sa sayaw ng <i>street dance competition</i> ang sining at pagiging malikhain ng nagkakaisang pangkat. Bago pa man ang araw na ito ay gaganapin, ibayong pag-eensayo ang kinakailangan upang matiyak na ang bawat pangkat ay handa. Makikita ang pagkakaisa ng mga kasapi ng Uhayan Festival sapagkat naipapamalas ng bawat purok ang kanilang natatanging kultura at interpretasyon sa Uhayan Festival sa pamamagitan ng isang patas at konstruktibong paligsahan.
Palarong Pinoy	May malaking ginagampanan sa Uhayan Festival ang mga programa tulad ng Palarong Pinoy sapagkat isa ito sa ilang pamamaraan upang itaguyod ang nagkakaisa at nagtutulungang pangkat. Ang mga laro tulad ng <i>agawang baboy palo sebo</i> , at <i>agawang buko</i> ay idinaraos sa kapanahunan ng Uhayan Festival



Variety Shows	sapagkat ito ay nagiging daluyan ng pagkakaisa at pagtutulungan ng pamayanan sa isang nakakatuwa at magaan na paraan. Sa konteksto ng Uhayan Festival, idinaraos ang <i>beauty pageants at Rosas ng Macablang</i> sapagkat ito ay isang kaganapan kung saan naipapamalas ng isang pangkat ang pagkakaisa sa pagpapakita ng suporta sa kanilang kinatawan. Nakikita dito kolaborasyon ng mga residente upang malikhaing bihisan at tiyakin na ang kanilang kinatawan ay handang makipagpaligsahan.
Ugnayan ng lokal na pamahalaan at simbahan	Isa sa mga katangian ng likas-kayang kapistahan ay ang kolaborasyon ng lokal na pamahalaan at simbahan. Sa Uhayan Festival, malinaw na ipinapakita ang pakikipag-ugnayan sa pagitan ng lokal na pamahalaan ng Macablang at ang simbahan. Sa pamamagitan nito, masinop na nailalatag ang gampanin ng dalawang mahalagang tagapagtaguyod ng kapistahan.

3.2 Pangkultural na Aspekto

Isa sa mga pamantayan upang masabing likas-kaya o sustentable ang isang kapistahan ay pagkakaroon nito ng mga gawaing nagtatampok sa natatanging kultura ng pamayanan. Nakapaloob sa pagdiriwang ng Uhayan Festival ang sari-saring gawain at programa na may kultural na kabuluhan at simbolismo.

Talahanayan 2. Mga Gawaing Nagpapakita ng Pangkultural na Aspekto ng Uhayan Festival

Pinakamahuhusay na Gawain	Gampanin sa Uhayan Festival
Malikhaing Kasuotan at Props na Nagpapakita sa Agrikultural na Kultura	Sa Uhayan Festival, masisilayan ang pagpapadaloy ng natatanging kultura sa pagsuot ng mga mananayaw ng damit na karaniwang suot ng mga magsasaka. Makikita rin na gawa sa palay, ang pangunahing produkto ng Macablang, ang mga props na kanilang ginagamit. Manipestasyon ito ng kulturang pang-agrikultura na taglay ng Macablang.
Pagsayaw	Ang pagsayaw ay isa sa mga paraan ng Uhayan Festival upang panatilihin ang kultura ng pagsasaka sa Barangay Macablang. Sa pamamagitan nito, malikhaing nailalapat ng mga mananayaw sa saliw ng awit ang galaw o kumpas na may kaugnayan sa pagsasaka.
Pagdakila at Pagkilala kay San Isidore Labrador	Malaking bahagi ng kasaysayan ng Barangay Macablang ang pagsasaka sapagkat isa ito sa mga dahilan kung bakit umunlad ang barangay. Ang Uhayan Festival ay isang papuri kay

Pagpapayaman sa Pampamilyang Pagpapahalaga	sa Malaki ang gampanin ng mga pampamilyang pagpapahalaga sa pagiging likas-kaya ng Uhayan Festival. Sa pamamagitan nito, napapanatili ang magandang relasyon ng mga kasapi ng isang pamilya dahil sila ay sama-samang naghahanda para sa Uhayan Festival. Isa rin itong panahon kung saan nagsasama at nabubuklod ang isang pamilya.
--	--

3.3 Pangkapaligirang Aspekto

Ipinamalas ng Uhayan Festival ang iba't ibang mga hakbang upang matiyak na napangangalagaan ang kapaligiran sa kabila ng magarbo at abalang pagtatampok ng kapistahan. Tinitiyak na hindi naisasakripisyo ang kalagayan ng kalikasan sa tuwing ginaganap ang Uhayan Festival.

Talahanayan 3. Mga Gawaing Nagpapakita ng Pangkapaligirang Aspekto ng Uhayan Festival

Pinakamahuhusay na Gawain	Gampanin sa Uhayan Festival
Kaligtasan ng Bawat Kasapi sa Uhayan Festival	Ang mga tagapagtaguyod ng pistahan ay nakikipag-ugnayan sa iba't ibang ahensya upang matiyak na ligtas at payapa ang pagdiriwang ng Uhayan Festival. Bukod dito, mayroon ding nakahanda na <i>emergency response team</i> ang Sangguniang Barangay sa panahon na may masaktan habang nagaganap ang pagdiriwang.
Kalinisan at Kaayusan ng Kapaligiran	Tinitiyak ang kalinisan ng kapaligiran sa Barangay Macablang sa gitna ng pagdiriwang ng Uhayan Festival. Ang Sangguniang Barangay ay nagtatakda ng mga susing tao at mga susing pangkat na nag-aayos at nagtatapon ng basura habang ginaganap ang pagdiriwang. Mahigpit at kontrolado ang proseso pagdating sa kalinisan ng kapaligiran.
Pangangasiwa sa Daloy ng mga Sasakyang	Dahil kailangan na ligtas ang mga mananayaw at ang mga manonood, ipinatupad ng opisyal ng Uhayan Festival na bawal dumaan ang mga kotse kapag sila ay namamarada. Nagsasara sila ng mga <i>entry points</i> upang walang kotse na makakapasok at nagkakaroon ng traffic plan upang matiyak din na hindi maantala ang karaniwang daloy ng mga sasakyang.
Integrasyon ng Kaalamang Pangkalikasan sa mga Gawain	Sa mga paligsahan katulad ng street dance competition, isa sa mga pamantayang tinitingnan ay kalinisan at kaayusan ng pagtatanghal. Bukod dito, kinakailangan din na ang mga materyales na gagamitin ay pawang recyclable at gawa sa mga indigenang material.



3.4 Paglalagom

Dinalumat ng pag-aaral na ito ang iba't ibang likas-kayang katangian ng Uhayan Festival sa Barangay Macabling, Sta. Rosa City, Laguna gamit ang balangkas na Pistang Pamana Pistang Naayon.

Ipinakita sa pag-aaral na ito ang kahalagahan ng iba't ibang aspekto upang magampanan ng iba't ibang kapistahan ang mga layunin nito habang tinitiyak ang pagiging likas-kaya nito. Ang mga kapistahan gaya ng Uhayan Festival ay isang produkto ng pagtutulungan ng iba't ibang mahahalagang sektor tulad ng lokal na pamahalaan, ang simbahan, gayundin ang mga mismong residente ng pamayanan na aktibong nakikiisa sa pagtatampok nito. Ang pagtatampok ng mga kapistahan ay tumatawid hindi lamang sa pagtatampok ng kultural na aspekto kundi pati rin ang pagpapakikita sa magandang ugnayan ng mga taong bahagi ng kapistahan habang tinitiyak ang pangangalaga sa kapaligiran. Inilatag ng pag-aaral na ito ang kahalagahan ng pagdalumat sa likas-kayang katangian ng isang kapistahan upang magsilbing pagtataya sa mga *stakeholders* ng kapistahan. Ang mga natukoy na gawain ay maaaring maging batayan ng mga tagapagtaguyod ng Uhayan Festival upang panatilihin ang pagiging likas-kaya ng Uhayan Festival.

Iminumungkahi ng pag-aaral na ito ang mas malalim pang pagdalumat sa mga likas-kayang katangiang taglay ng mga kapistahan mula sa pananaw ng ibang stakeholders. Mahalagang mapag-aralan ang mga likas-kayang katangian ng kapistahan mula sa perspektibo ng mga residente, ng mga nagtatanghal sa kapistahan gayundin ang mga bisita at turistang tumutunghay na sa kapistahan. Bukod dito, mas mapayayaman pa ang mga ganitong uri ng pag-aaral kung mararanasan mismo ng mga mananaliksik ang pagdiriwang ng kapistahan upang makakalap ng mga pangunahin (primary data) datos.

4. PAGKILALA AT PASASALAMAT

Nais kilalanin at pasalamatang mga mananaliksik ang mga sumusunod na taong naging bahagi ng pag-aaral na ito:

G. Jeyson Taeza, ang nagsilbing gabay at tagapayo ng mga mananaliksik sa pag-aaral na ito na walang sawang nagbigay ng mga mungkahi para sa pagpapabuti ng papel;

G. Janeson Miranda, ang nagsilbing tagapagturo para sa kursong Practical Research 3 at Practical Research 4 sa mga ginanap na mga sesyong naging batayan upang lalong palawigin ang pananaliksik na ito;

Ang lahat ng kaklase at kaibigan ng mga mananaliksik, sa walang sawang suporta na ipinamalas nila ay lubos na nakatulong sa

pagpapalakas ng loob at kumpiyansang matagumpay na matatapos ang papel na ito;

Sa kanilang mga magulang ng mga mananaliksik, ang isa sa mga rason upang sila ay makapag-aral, makapagsaliksik, at makapagtapos ng pag-aaral.

5. Sanggunian

- Amtalao, J., & Lartec, J. (2015). Ang wika ng Sillag festival bilang daluyan ng kultura at identidad ng mga Pilipino. *Malay* 27.2.
- Apostolakis, V., & Viskadouraki, I. (2017). Analysis of the economic impact of cultural festivals in the local economy. *Cultural Management: Science and Education*, 1(2), 47-64. <https://doi.org/10.18502/kss.v3i6.2407>
- Bandala, I. (2018). Pistang Pamana, Pistang Naaayon: A socio-cultural and environmental sustainability framework for town fiestas. *KnE Social Sciences*. <https://doi.org/10.18502/kss.v3i6.2407>
- Theodori, G., & Luloff, A. (1998). Land use and community attachment. 7th International Symposium on Society and Resource Management, University of Missouri.
- Tyrell, T., et al. (2013). A quantified triple bottom line for tourism: Experimental results. *Journal of Travel Research*, 52(3), 279-293. <https://doi.org/10.1177/0047287512465963>.
- Quinn, B. (2006). Problematising 'Festival Tourism': Arts Festivals and Sustainable Development in Ireland. Retrieved January 28, 2021, from <https://www.tandfonline.com/doi/abs/10.1080/09669580.608669060>
- Quinn, B. & Wilks, L. (2013). Festival connections: people, place and social capital. *Exploring the Social Impacts of Events*, 15 – 30. <https://doi.org/10.13140/2.1.2269.7281>
- Wee, H. (2015). Potential factors that influence event sustainability: A case of special event. *International Journal of Arts and Commerce*, 4, 1-10.



Kamalayan, Pag-aangkop, at Pagpapatuloy: Pagbalangkas sa Diwa at Danas ng mga Comedy Bar Performers sa Panahon ng Pandemya Gamit ang Konsepto ng “Loob” ni Fr. Albert Alejo

Beatriz Eloisa C. Colar, Frances Mari F. Constantino, and Justine Anne Y. Rosete
De La Salle University Integrated School, Biñan City, Laguna

Jeyson T. Taeza, Research Adviser
De La Salle University Integrated School, Biñan City, Laguna

Abstrak: Ang pandemyang COVID-19 ay maituturing na pinakamalubhang pangkalusugang krisis na kinahaharap ng Pilipinas. Maraming sektor ng lipunan ang naapektuhan tulad ng edukasyon, transportasyon, at ekonomiya, lalo na ang industriya ng entertainment. Sa industriyang ito, isa sa mga pinakanaapektuhan ang mga comedy bar performers dahil sa pansamantala o permanenteng pagsasara ng mga comedy bars na pangunahing pinagkukunan nila ng kabuhayan. Layunin ng pag-aaral na balangkasin ang diwa at karanasan ng mga comedy bar performers sa panahon ng pandemya gamit ang “Konsepto ng Loob” ni Fr. Albert Alejo. Sinuri sa pag-aaral ang kamalayan ng mga comedy bar performers sa panahon ng pandemya (Abot-Malay), ang kanilang mga pag-aangkop sa kasagsagan ng pandemya (Abot-Dama), at ang mga paraan ng pagpapatuloy ng mga comedy bar performers sa panahon ng pandemya (Abot-Kaya). Kinalap ang mga datos sa pamamagitan ng dalawang serye ng katutubong pamamaraan na Pakikipagkuwentuhan sa mga comedy bar performers. Ang mga nakalap na datos ay sumailalim sa proseso ng transkripsiyon at coding. Sinuri at isinatema ang mga nakalap na datos batay sa iba’t ibang aspekto ng “Konsepto ng Loob.” Batay sa pag-aaral, malay ang mga kalahok sa kalagayan ng kanilang kapaligiran. Ang kamalayang ito ang pangunahing dahilan ng kanilang reaksyon at pagtugon sa pandemya. Samakatuwid, ang pag-aangkop sa panahon ng pandemya ay hindi lamang nakatuon sa pansariling kagustuhan ng isang indibidwal na ito ay mapagtagumpayan. Ito ay isang multi-sektoral na pagsulong na kinabibilangang ng sistematikong paglalalatag at pagpapatupad ng mga plano at polisiya.

Mga Susing Salita: pandemya; comedy bar performers; Abot-Malay; Abot-Dama; Abot-Kaya

1. PANIMULA

Ang pandemyang COVID-19 ay maituturing na pinakamalubhang krisis pangkalusugan na kinakaharap ng daigdig mula noong Ikalawang Digmaang Pandaigdig (Chakraborty at Maity, 2020). Kinilala ng World Health Organization (WHO) noong Enero 30, 2020 ang COVID-19 bilang isang *health emergency crisis* at kalaunan ay idineklara na isang pandemya dahil sa patuloy na pagkalat nito sa iba’t ibang panig ng mundo (Dubey et al., 2020). Ayon sa tala ng WHO noong Enero 23, 2021, umabot na sa 96,877,399 ang bilang ng kumpirmadong kaso at 2,098,879 naman ang bilang ng mga nasawi dahil sa sakit.

Sa Pilipinas, noong Marso 7, 2020, naitala ng Department of Health (DOH) ang unang lokal na transmisyon sa bansa. Noong Marso 8, 2020 naman ay nagdeklara ng *state of national emergency* (Vallejo Jr at Ong, 2020) dahil sa patuloy na pag-akyat ng mga

kaso. Idineklara na ang National Capital Region (NCR) ay sasailalim sa *quarantine* at kalaunan ay ipinatupad na rin ito sa buong Luzon.

Malaki ang naging epekto ng pandemya sa iba’t ibang sektor ng Pilipinas tulad ng edukasyon, transportasyon, at ekonomiya. Maraming mga Pilipino ang nawalan ng trabaho dahil sa mga restriksiyong ipinatupad. Ayon sa tala ng Philippine Statistics Authority noong Enero 2021, apat na milyong Pilipino ang walang trabaho (de Vera at Canivel, 2021). Dahil hindi makapagtrabaho, marami ang nakadepende sa suportang ibinibigay ng pamahalaan. (Purugganan, 2020).

Isa ang *entertainment industry* sa nakaranas ng matinding epekto mula sa pandemya (Senate of the Philippines, 2020). Ayon sa ulat ng Philippine Statistics Authority noong Abril 2020, ang mga trabaho mula sa *arts, entertainment, at recreation* ay ang pinakamataas na *sub-sektor* na nawalan ng



hanapbuhay na umabot ng 54% (de Vera, 2020). Ayon sa pahayag ng Film Development Council of the Philippines (FDPCP) Chairperson at CEO Lisa Dino-Seguerra, ang mga manggagawa sa ilalim ng industriya na ito ay hindi nakatanggap ng anomang *cash aid* mula sa pamahalaan (Senate of the Philippines, 2020). Sila ay ikinunsiderang bahagi ng impormal na sektor dahil hindi sila kabilang sa “*most vulnerable*”. Kabilang ang *arts, dance, music, theater*, at *comedy industry* sa mga naapektuhan sa ilalim ng industriyang ito.

Sa ilalim ng industriyang ito, lubhang naapektuhan ang *comedy bar industry*. Nagsara ang iba’t ibang comedy bars na dahilan upang mawalan ng trabaho ang maraming comedy bar performers sa bansa. Dahil dito, ang ilan ay bumalik sa kanilang dating mga trabaho o nagbenta online (Cruz, 2020).

Ang pandemyang COVID-19 ay isang kalamidad na bago at hindi nakasanayan ng mga Pilipino. Ang Pilipinas ay lantad sa iba’t ibang kalamidad tulad ng bagyo, lindol, baha, at iba pa. Ayon sa mga pag-aaral, ipinamalas ng mga Pilipino ang iba’t ibang paraan upang umangkop sa kalamidad, ilan dito ang pagtulong sa sarili at pamilya (Lapa, et al., 2016); pagtulong sa kapwa (Badie, 2020); pananampalataya sa Diyos (Gil Cuesta et al., 2018); pagtanggap sa kanilang sitwasyon (Garcia et al., 2016); pagiging maparaan (Cutillas et al., 2015); paggamit ng *humor* (Anga at Diaz, n.d.); at pagkakaroon ng pag-asa na sila ay makakabangon (Bantayan at Cabintoy, 2019).

Ang karanasan ng mga Pilipino sa pangkalusugang krisis ay hindi pa malalim na napag-aaralan at naidodokumento. Batay sa paggalugad ng mga mananaliksik sa mga mapagkakatiwalaang database tulad ng Philippine E-journals, EbscoHOST, at Google Scholar, iilan pa lamang ang mga pag-aaral na pumaksa sa nasabing usapin. Bukod dito, wala pang pag-aaral na naging tiyak na dalumatin ang karanasan ng mga Pilipinong kabilang sa impormal na sektor na hindi nakatanggap ng anomang tulong mula sa pamahalaan tulad ng mga *comedy bar performers*. Mahalagang mailagay at mapag-usapan sa ganitong uri ng diskurso ang karanasan ng mga *comedy bar performers* upang maibahagi ang kanilang mga kuwentong-buhay sa panahon ng pandemya. Ang pag-aaral na ito magsisilbing instrumento upang mailarawan ang tunay na kalagayan ng mga nasa *entertainment industry* partikular ang mga *comedy bar performers* na lubha ring naapektuhan ng pandemya.

1.1 Konseptwal na Balangkas

Upang balangkasin ang diwa at danas ng mga *comedy bar performers* sa panahon ng pandemya, ginamit ng pag-aaral na ito ang Konsepto ng “Loob” ni Fr. Albert Alejo. Ayon kay Alejo (2018), ang pag-

unawa ng tao ay di lang pagmamasid sa kanyang paligid kundi pag-unawa rin ng kanyang “Loob”. Ang Loob ng Pilipino ay masalimuot at dinamiko na nagsisimula sa sarili patungo sa pakikipag-ugnay at pagkakasangkot sa panlabas. Sa pagbubuo ng Loob, ang tao ay hindi lang pagmumulat sa sariling kamalayan at pakiramdam, kundi pagsasaayos din ng malay at dama sa paraang tugma sa pagkakaunawa sa kanyang paligid at sa mga pangyayari. Ang “Loob” ay binubuo ng tatlong aspekto: Abot-Malay na tumutukoy sa kaalaman sa kalagayan, sanhi ng problema, at lagay ng pamayanan; Abot-Dama na tumutukoy sa pakiramdam, kasama rin dito ang damdamin, ugali, at kakayahan sa sitwasyong nararanasan; at Abot-Kaya na tumutukoy sa pagbubuo ng Loob, partikular ang desisyon at aksyon ng tao bilang tugon sa mga suliranin at udyok ng kalooban.

Ang Konsepto ng “Loob” ay nagamit lamang sa karanasan ng mga Pilipino sa baha at bagyo, ngunit hindi pa ito nagagamit sa pag-aangkop ng mga Pilipino sa panahon ng krisis pangkalusugan (Ardales, 2015). Binalangkas ng pag-aaral na ito ang Abot-Malay na sumasaklaw sa kaalaman at kamalayan ng mga *comedy bar performers* sa panahon ng pandemya, ang Abot-Dama na tungkol sa mga damdaming nararanasan ng mga *comedy bar performers* sa mga hamon at pagsubok na dala ng pandemya, at Abot-Kaya na hinggil naman sa ginagawang reaksyon at pagtugon ng mga *comedy bar performers* upang matugunan ang mga epekto ng pandemya.

1.2 Layunin ng Pag-aaral

Sa panahon ng pandemya, maraming sektor sa Pilipinas ang malubhang naapektuhan dulot ng mga hamon na dala nito. Isa na rito ang *entertainment industry*, partikular ang mga *comedy bar performers* dahil sa pansamantala o patuloy na pagsasara ng mga *comedy bars* na pangunahing pinagkukunan ng kabuhayan. Layunin ng pananaliksik na ito na pag-aralan ang diwa at danas ng mga *comedy bar performers* sa panahon ng pandemya gamit ang Konsepto ng “Loob” ni Fr. Albert Alejo. Tiyak na layunin ng pag-aaral na ito na:

1. suriin ang kamalayan (Abot-Malay) ng mga *comedy bar performers* sa panahon ng pandemya;
2. mailarawan ang kanilang mga pang-aangkop (Abot-Dama) sa kasagsagan ng pandemya at,
3. isalaysay ang pagpapatuloy (Abot-Kaya) ng mga *comedy bar performers* sa panahon ng pandemya.

2. METODOLOHIYA



Ang kwalitatibong pag-aaral na ito ay gumamit ng penomenolohikal na lapit sa pananaliksik upang dalumin ang kuwentong-buhay at karanasan ng mga *comedy bar performers* sa panahon ng pandemya. Bukod dito, ang mga datos ay kinalap sa pamamagitan ng katutubong pamamaraan na pakikipagkuwentuhan (*informal conversation*). Ang ganitong paraan ng pagkalap ng mga datos ay angkop sa pag-aaral upang malayang maikuwento ng mga kasangkot sa pag-aaral ang kanilang karanasan.

Labing-isa (11) ang kabuuang bilang ng mga *comedy bar performers* na boluntaryong naging kasangkot sa pag-aaral na ito. Ang mga kasangkot sa pag-aaral ay pinili sa pamamagitan ng *chain-referral sampling* at tiniyak na taglay nila ang mga sumusunod na katangian: may gulang 18 pataas, pangunahing kabuhayan ang pagiging isang *comedy bar performers*, at nawalan o nagsara ang pinapasukang bar dahil sa pandemya.

Bagamat pakikipagkuwentuhan ang ginamit na paraan ng pagkalap ng datos, naghanda ang mga mananaliksik ng mga gabay na katanungang sumailalim sa *content validity* upang matiyak na makakalap ang mga kinakailangang datos sa pag-aaral. Ibinatay sa Konsepto ng “Loob” ni Fr. Albert Alejo: ang Abot-Malay, Abot-Dama, at Abot-Kaya ang pakikipagkuwentuhan. Ang unang serye ng pakikipagkuwentuhan ay nakatuon sa oryentasyon at pagbuo ng magandang ugnayan sa pagitan ng mga kasangkot sa pag-aaral at mananaliksik upang mas malayang maikuwento ng mga kalahok ang kanilang mga karanasan. Sa unang serye rin naganap ang unang bahagi ng pakikipagkuwentuhan. Samantala, ang ikalawang serye naman ay nakapokus sa balidasyon ng kawastuhan ng mga nakalap na datos lalo na’t ang pakikipagkuwentuhan ay naganap sa pamamagitan ng *video conference*.

Sa pahintulot ng mga kasangkot sa pag-aaral, ang kabuuan ng pakikipagkuwentuhan ay inirekord at sumailalim sa proseso ng transkripsiyon at coding. Ang mga naprosesong kasagutan ay binalangkas at sinuri gamit ang mga aspekto ng Konsepto ng “Loob”: Abot-Malay, Abot-Dama, at Abot-Kaya.

3. RESULTA AT PAGTALAKAY

Binalangkas at tinalakay sa bahaging ito ang karanasan ng mga *comedy bar performers* sa gitna ng pandemya gamit ang iba’t ibang aspekto ng Konsepto ng “Loob”. Nahati ang pagtalakay sa tatlo: Abot-Malay, Abot-Dama, at Abot-Kaya.

3.1. Abot-Malay

Ipinapakita ng mga datos na nakalap ang kamalayan ng mga *comedy bar performers* sa kasagsagan ng pandemya. Ayon sa pag-aaral nina Cutillas et al. (2015), mahalaga ang pagkakaroon ng

kaalaman at kamalayan sa epekto ng iba’t ibang kalamidad upang makapaghanda at posibleng mabawasan ang paglala nito. Mahihinuha dito na ang mga kalahok ay mayroong kaalaman sa panahon ng krisis upang malagpasan ang mga pagsubok na dala nito.

Mula kay Ardales (2015), sakop ng Abot-Malay ang kaalaman tungkol sa kalamidad. Dala ng hindi inaasahan ang pagpasok ng pandemya, ang karamihan sa mga kalahok ay hindi nakapaghanda. Dahil pansamantala o permanenteng nagsara ang kanilang mga pinagtatrabahuhan, naapektuhan ang kanilang pinansyal na kapasidad. Hindi makamit ng karamihan ang pang-araw-araw na pangangailangan at hindi rin sila nakakuha ng sapat na tulong mula sa gobyerno. Mayroon ding epekto ang pandemya sa kanilang komunidad. Kahit mas umayos na ang kalagayan ng lugar para sa ilan, mayroon pa ring mga protokol. Bilang karagdagan, naapektuhan ang *mental health* ng kanilang mga kasamahan sa *comedy bar*. Problema rin nila ang kakulangan sa pera. Isang pagsubok ang pandemya sa *comedy industry*. Bagaman may ilang *comedy bars* na ang nagbukas, hindi pa rin ito *fully operational*. Naging sorpresa sa mga kalahok ang panahon na itinagal ng pandemya. Makikita dito na mayroong kakulangan sa kaalaman ang mga kalahok tungkol sa paghahanda, ngunit naging malay sila sa mga nangyayari sa kanilang paligid sa kasagsagan nito. Alam nila ang sitwasyon ng kanilang komunidad at ang hirap na nararanasan ng *comedy industry* at kapwa *performers*. Marami ang gumamit ng teknolohiya upang malaman ang mga ito. Kahit malubha ang kanilang naging sitwasyon, tingin pa rin nila na babalik sa dati ang daloy ng *comedy bar performing*.

3.2. Abot-Dama

Nagdulot ng iba’t ibang damdamin at reaksyon ang pandemya mula sa mga kalahok. Ayon sa mga nakalap na datos, positibo at negatibo ang mga ito. Kahit na sila ay nakakaranas ng mga matinding balakid, kinakaya nilang malagpasan ang mga ito at patuloy pa ring nagsusumikap upang makabangon.

Mula sa pag-aaral ni Ardales (2015), ang Abot-Dama ay tumutukoy sa pakiramdam ng tao sa nagaganap na kalamidad at sa personal na ugali o katangian na ipinamalas sa kahirapang dulot ng kalamidad. Nakaramdam ng kalungkutan at pagkabalisa ang mga kalahok noong nagsara ang mga *comedy bar* na kanilang pinagtatrabahuhan. Sila ay nabigla sa mga naging epekto ng pandemya sa kanilang mga buhay. Sa kasalukuyan, dahil sa mga pagbabagong kanilang nararanasan, kapansin-pansin na sila ay nahihirapan. Sa kabila nito, nananatili pa rin silang positibo at determinadong iahon ang kanilang sarili mula sa mga paghihirap na kanilang nararanasan dulot ng pandemya. Dahil mayroong



ilang *comedy bar* ang unti-unting nang nagbubukas, umaasa sila na babalik sa dati ang daloy ng *comedy bar performing*. Sila ay handang bumalik sa pagiging isang *comedy bar performer* kapag nabigyan sila ng pagkakataon. Mayroon pa rin silang hilig na magpasaya ng mga tao at magtanghal sa entablado. Dahil sila ay *comedy bar performers*, pagiging masayahin ang katangiang nadala nila at nakatulong upang harapin ang mga pagsubok ng pandemya. Namamalagi ang pagiging positibo sa kasagsagan ng krisis na ito, napapatawa at napapangiti nila ang mga tao sa kanilang paligid. Gaya ng nabanggit sa pag-aaral ni Yapan (2019), kayang harapin ng mga tao ang sakuna sa tulong ng kanilang emosyon. Mahihinuha na ang kanilang nararamdaman at ugaling ipinamalas ay konektado sa kanilang sitwasyon at paligid pati na rin ang angking pagkilos upang maitawid ang pang araw-araw na pangangailangan. Dulot din nito ang kanilang sitwasyon at kamalayan sa nangyayari sa paligid habang ang kanilang angking pagkilos ay epekto ng kanilang nararamdaman at ugaling ipinamalas.

3.3. Abot-Kaya

Ayon sa datos, ang mga kalahok ay may iba't ibang paraan upang umangkop sa mga pagsubok na kanilang nararanasan. Tinanggap nila ang mga naging pagkakaiba ng kanilang buhay noon sa ngayon at patuloy na hinaharap ang mga hamon na dala ng pandemya.

Ang Abot-Kaya ay ang reaksiyon na tumutugon sa panganib at angking pagkilos at desisyon upang pansamantalang makaraos sa panahon ng kalamidad (Ardales, 2015). Ayon kay Alejo (2018), ito ay ang pagtugon sa Abot-Malay at Abot-Dama. Ang pandemya ay hindi inaasahan ng nakararami. Ang mga sakuna ay may iba't ibang konteksto, gayunpaman ang alaala ng lipunan mula sa mga nakaraang sakuna ay maaaring hindi magamit sa pagtugon sa nararanasan. Kaya, anomang epekto ng sakuna ay kinakailangan gamitan ng *resiliency* (Candelaria, 2016). Dahil nagsara ang kanilang pinagtatrabahuhan, kinailangan nilang maghanap ng ibang paraan upang kumita para matugunan ang kanilang mga pangangailangan. Hindi man hilig ng iba ang hanapbuhay na kanilang pinasukan, pursigido pa rin silang ipagpatuloy ito. Nagdala ng stress ang epekto ng pandemya sa mga kalahok. Dahil dito, mayroon silang iba't ibang paraan na produkto ng kanilang pagkamalikhain upang gumaan ang kanilang nararamdaman. Bilang karagdagan, malay sila sa mga negatibong nangyari sa kanilang paligid. Kahit na nagdulot ito ng kalungkutan, hinaharap nila ito at patuloy na nangangarap. Ipinapakita rito na sinusubukan nilang umayon sa naging sitwasyon upang malagpasan ang mga paghihirap na kanilang nararanasan.

3.4. Paglalagom

Binalangkas ng pag-aaral na ito ang diwa at danas ng mga *comedy bar performers* sa panahon ng pandemya gamit ang Konsepto ng “Loob” ni Fr. Albert Alejo.

Ipinakita ng pag-aaral ang pagiging malay ng mga *comedy bar performer* sa mga nangyayari sa kanilang paligid. Ang kanilang kamalayan ay tumatawid mula sa panloob na kamalayan tungo sa panlabas na kamalayang pumapaksa sa politikal at kasalukuyang kalagayan ng kanilang pamayanan. Malaki ang ginampanan ng kamalayang ito sa kanilang aksyong ginagawa upang pansamantalang makaraos sa panahon ng kalamidad batay sa kanilang pansariling mga pagpapahalaga at paniniwala upang tugunan ang mga pinsalang dulot ng pandemya. Ipinakita sa pag-aaral na bukod sa pansariling pagpapahalaga at paniniwala, malaki rin ang papel ng mga panlabas na aspekto tulad ng pamilya, lipunan, at pamahalaan upang matagumpay na makaangkop sa mga hamong ito.

Gamit ang mga awtentikong datos, kinumpirma ng pag-aaral na ito ang tunay na kalagayan ng isang bulnerableng sektor na hindi nabibigyan ng pansin. Bagamat ipinamalas ng mga *comedy bar performers* ang iba't ibang malilikhaing pamamaraan upang maibsan ang dagok na dala ng pandemya, hindi maitatangi ang agarang pagtugon ng kinauukulan sa kanilang mga pangangailangan. Ang pag-aangkop sa pandemya ay hindi lamang nakabatay sa kagustuhan ng isang indibidwal na ito ay mapagtagumpayan bagkus ito ay isang multi-sektoral na pagsulong na kinabibilangan ng sistematikong paglalalatag at pagpapatupad ng mga plano at polisiyang titiyak sa magandang kalagayan ng mga tao. Ang pandemya ay isang isyung dapat mas bigyang-pansin dahil isa itong suliranin na patuloy na nakakaapekto hindi lamang sa mga *comedy bar performers*, ngunit pati na rin sa pangkalahatang pamumuhay ng mga Pilipino.

Iminumungkahi ng papel na ito ang mas malalim pang pag-aaral ukol sa kalagayan ng ibang bulnerableng sektor na patuloy na naaapektuhan ng pandemya. Mainam na magkaroon ng isang longitudinal na pag-aaral upang higit pang mabuo ang pagbalangkas sa karanasan ng mga *comedy bar performers* sa panahon ng pandemya. Mainam ding pag-aralan kung paano nabago ng pandemya ang estilo at naratibo ng mga *comedy bar performers* sa kanilang mga pagtatanghal.

4. PAGKILALA AT PASASALAMAT

Nais ng mga mananaliksik na ipaabot ang kanilang pasasalamat sa mga kalahok ng pag-aaral sa paglalaan ng oras. Sa kabila ng hirap na kinakaharap sa gitna ng pandemya, hindi ito naging hadlang at



patuloy silang nagpakita ng interes sa pagbabahagi ng kanilang kuwento. Namulat ang mga miyembro sa kanilang mga ibinahaging karanasan at magsisilbing inspirasyon upang maibahagi ang kanilang karanasan sa mga ganitong uri ng diskurso.

Taos-puso rin silang nagpapasalamat sa mga guro, lalo na sa kanilang tagapayo na si G. Jeyson Taeza, na patuloy na gumabay sa pagsusulat ng pananaliksik. Mainit na pagpapasalamat din ang nais ipaabot ng mga mananaliksik sa kanilang mga magulang para sa pagpopondo at pagbibigay ng suporta sa pananaliksik. Dahil sa inyong mga suporta, naisakatuparan nila ang isang makabuluhang pag-aaral. Maituturing na isang mabungang paglalakbay ang pagbuo nito. Kahit maraming pagsubok ang napagdaanan ng bawat isa sa proseso, marami silang aral at pagpapahalaga na natutuhan dito. Napabuti ang kanilang kahusayan sa komunikasyon at nahasa ang kanilang pagsusulat sa Filipino.

5. SANGGUNIAN

- Alejo, A. E., S.J. (2018). "Loob Ng Tao." *Social Transformations: Journal of the Global South*, 6(1), 25-53.
https://www.researchgate.net/publication/325494603_L_oob_ng_Tao
- Anga, M. C. C., & Diaz, L. B. L. (n.d.). Perception, Resiliency and Coping Strategies of Filipinos. Bulacan State University. Research, Extension & Training. 1-9 <https://bulsu.edu.ph/research/university-research-office/research-publications/2/perception-resiliency-and-coping-strategies-of-filipinos-amidst-disasters>.
- Ardales, A. J. (2015). "K-U-L-T-U-R-A: Ang Karanasan Nina Nanay Marina at Gemma Tungkol Sa Problema Ng Pagbaha Sa Brgy. Aplaya, Sta. Rosa, Laguna / K-U-L-T-U-R-A: The Experience of Nanay Marina and Gemma on the Flooding Problem in Brgy. Aplaya, Sta. Rosa, Laguna." *MALAY*, 27(20), 102-117.
<https://ejournals.ph/article.php?id=8079>
- Badie, J. Y. (2020). TÁBANG SA PANAHOON NG PANDEMYA: SALAYSAY NG TATLONG TRINITARIAN. *Dalumat E-Journal*, 6(2), 1-9.
<https://ejournals.ph/article.php?id=16038>
- Bantayan, R. P., & Cabintoy, L. C. (2019). SURVIVING LIFE AFTER TYPHOON PABLO: STRUGGLES OF SCHOOL MANAGERS. *Southeast Asian Journal of Educational Management*, 1(1).
<https://ejournals.ph/article.php?id=14465>.
- Candelaria, J. L. (2016). Pagkakakilanlan, Pagdurusa, at Pagbangon: Bagyong Reming (2006) sa Alaala ng Anislag Resettlement Community. *Saliksik E-Journal* 5(1).
https://www.researchgate.net/publication/335260930_Pagkakakilanlan_Pagdurusa_at_Pagbangon_Bagyong_Reming_2006_sa_Alaala_ng_Anislag_Resettlement_Community
- Chakraborty, I., & Maity, P. (2020). COVID-19 outbreak: Migration, effects on society, global environment and prevention. *Science of The Total Environment*, 728, 138882. <https://doi.org/10.1016/j.scitotenv.2020.138882>
- Cruz, M. (2020, September 14). How Wacky Kiray adapts to limited opportunities during pandemic. <https://www.pressreader.com/philippines/philippine-daily-inquirer-1109/20200914/282243783009783>
- Cutillas, A. L., Alburo, R. P., Alburo, H. M., & Pascual, P. R.L. (2015). COPING STRATEGIES OF COMMUNITIES AFFECTED BY THE BOHOL EARTHQUAKE. *Tropical Technology Journal*, 18(2), 1-11.
https://www.researchgate.net/publication/343880631_COPING_STRATEGIES_OF_COMMUNITIES_AFFECTED_BY_THE_BOHOL_EARTHQUAKE
- Department of Health. (n.d.). "COVID-19 Tracker." Department of Health, www.doh.gov.ph/covid19tracker
- de Vera, B. O. (2020). Amid ECQ, 'record-high' unemployment rate of 17.7% posted in April. *INQUIRER.Net*.
<https://business.inquirer.net/299124/amid-ecq-record-high-unemployment-rate-of-17-7-posted-in-april>
- de Vera, B. O. & Canivel, R. S. (2021). 4 million Filipinos jobless in January 2021. <https://newsinfo.inquirer.net/1405074/4m-pinoys-jobless-in-january#:~:text=Dennis%20Mapa%2C%20the%20national%20statistician,the%20same%20month%20in%202020>
- Dubey, S., Biswas, P., Ghosh, R., Chatterjee, S., Dubey, M. J., Chatterjee, S., Lahiri, D., & Lavie, C. J. (2020). Psychosocial impact of COVID-19. *Diabetes & Metabolic Syndrome: Clinical Research & Reviews*, 14(5), 779-788. <https://doi.org/10.1016/j.dsx.2020.05.035>
- Garcia, L., Lapa, M. M. I., & Palompon, D. (2016). Surviving Typhoon Yolanda (Haijan): Experiences of Older Adults in a Rural Area in the Philippines. *International Journal of Sciences*, 5(11), 1-6.
https://www.researchgate.net/publication/321965863_Surviving_Typhoon_Yolanda_Haijan_Experiences_of_Older_Adults_in_a_Rural_Area_in_the_Philippines
- Gil Cuesta, J., van Loenhout, J. A. F., de Lara-Banquesio, M. L., Isiderio, J. M., Aujoulat, I., & Guha-Sapir, D. (2018). The Impact of Typhoon Haiyan on Health Staff: A Qualitative Study in Two Hospitals in Eastern Visayas, The Philippines. *Frontiers in Public Health*, 6. <https://doi.org/10.3389/fpubh.2018.00208>
- Lapa, M. M. I. M., Palompon, D. R., & Garcia, L. L. (2016). Experiences with Typhoon Yolanda: The voices of young survivors revealed. *Journal of Nursing Education and Practice*, 6(12), 136-141.
<https://doi.org/10.5430/jnep.v6n12p136>
- Senate of the Philippines. (2020). Press Release - FDCP Chair thanks Sen. Revilla for championing plight of entertainment industry during COVID-19 pandemic. http://legacy.senate.gov.ph/press_release/2020/0529_revilla1.asp
- Purugganan, J. (2020). Philippines: Informal Workers face brunt of COVID-19 Lockdown. <https://focusweb.org/philippines-informal-workers-face-brunt-of-covid-19-lockdown/>
- Vallejo, B. M., & Ong, R. A. C. (2020). Policy responses and government science advice for the COVID 19 pandemic in the Philippines: January to April 2020. *Progress in Disaster Science*, 7, 1-7.
<https://doi.org/10.1016/j.pdisas.2020.100115>



3RD DLSU SENIOR HIGH SCHOOL RESEARCH CONGRESS

2020-2021

MEDIA AND PHILIPPINE STUDIES

- World Health Organization. (n.d.). WHO Coronavirus Disease (COVID-19) Dashboard.
<https://covid19.who.int/>
- Yapan, A. (2019). Desakralisasyon ng “Sakuna” Bilang Disaster sa Karanasang Filipino (Desacralization of “Sakuna” as Disaster in the Filipino Experience). *Katipunan*, 4, 89-129.
https://www.researchgate.net/publication/350035960_Desakralisasyon_ng_Sakuna_Bilang_Disaster_sa_Karanasang_Filipino_Desacralization_of_Sakuna_as_Disaster_in_the_Filipino_Experience



Mga Proseso at Naratibo: Isang Preliminaryong Pagtatala sa Magnetic Folk Healing Bilang Katutubong Pamamaraan ng Pagpapagaling sa Barangay Kinabuhayan at Sta. Lucia, Dolores, Quezon

Maria Elnora A. Abante and Kyla Therese G. Quebrar
De La Salle University Integrated School, Biñan City, Laguna

Jeyson T. Taeza, *Research Adviser*
De La Salle University Integrated School, Biñan City, Laguna

Abstrak: Ang Pilipinas ay mayaman sa iba't ibang katutubong pamamaraan ng pagpapagaling na may kaugnayan sa kultura, paniniwala, at tradisyon ng mga Pilipino. Sa kasalukuyan, marami pa ring mga katutubong pamamaraan ng pagpapagaling sa bansa ang hindi naitatala, partikular ang ilang mga lugar na malapit sa Bundok Banahaw. Layunin ng pag-aaral na ito na magsagawa ng isang preliminaryong pagtatala sa magnetic folk healing bilang katutubong pamamaraan ng pagpapagaling sa Barangay Kinabuhayan at Sta. Lucia, Dolores, Quezon. Ang case study na ito ay nakapokus kay Ate Mel, isang magnetic folk healer. Kinalap ang mga datos sa katutubong pamamaraan ng pakikipagkwentuhan at nakikiugaling pagmamasiid. Sinuri ang mga datos batay sa paraan ng pagtamo ng magnetic folk healing, proseso ng pagpapagaling, at mga naratibong may kaugnayan sa mga paniniwala sa Bundok Banahaw. Ang paraan ng pagtamo ng magnetic folk healing ay nakaangkla sa kapangyarihan na nakapaloob sa Bundok Banahaw sa Dolores, Quezon. Ang kakayahan ng magnetic folk healer ay ipinagkakaloob sa mga taong may pananampalataya at paggalang sa kapangyarihang taglay ng Bundok Banahaw. Inilatag din ng pag-aaral na ito ang mga proseso ng pagriritwal at materyales na ginamit sa magnetic folk healing tulad ng langis. Siniyasat din ng pag-aaral na ito ang mga naratibong mula sa kasangkot ng pag-aaral na may kaugnayan sa mga paniniwala sa mga nilalang na nasa ikatlong uri, tulad ng engkanto, duwende, at mga espiritu. Sa pangkalahatan, sa kabila ng pag-usbong ng modernong medisina, nananatiling may mga Pilipinong sumasangguni sa mga katutubong pamamaraan ng pagpapagaling tulad ng magnetic folk healing.

Key Words: magnetic folk healing; proseso; ritwal; katutubo; Bundok Banahaw

1. PANIMULA

Bago pa man dumating ang mga dayuhan sa Pilipinas, taglay na ng mga sinaunang Pilipino ang napakayamang kultura. Kabilang sa yamang taglay ng sinaunang Pilipinas ay ang mga iba't ibang katutubong pamamaraan ng pagpapagaling. Itinuturing na mahalagang salik ang katutubong kaalaman, kultura, at tradisyunal na gawain sa pagpapaunlad ng katutubong pamamaraan ng pagpapagaling. Samakatuwid, ang mga ito ay makabuluhan sa sistema ng pangangalaga ng kalusugan sa mga lokal na komunidad (F. L. Jocano, 1966; Mc Laughlin & Braun, 1998).

Iba't ibang uri ng katutubong pamamaraan ng pagpapagaling ang patuloy na umiiral sa iba't ibang bahagi ng bansa. Ang ilang halimbawa ay ang Dawaks ng mga Kalingas (Martin et al., 2012), ang mga pang gawi ng pangkat etnikong Pala'wan

(Villapa, 2017), ang Sahuma mula sa Zamboanga City (Esperat et al., 2020), at ang mga mananambal ng Cebu (Berdon, 2016). Bukod dito, ayon kay Gaabucayan (1971), laganap din ang mga manggagamot tulad ng albularyo, herbolario, manghihilot, mananambang, mananawal, at mambabarang.

Sa kabila ng patuloy na pag-iral ng mga katutubong pamamaraan na nakaangkla sa kultura at paniniwala ng mga Pilipino, isa sa mga maituturing na hamon sa mga ganitong uri ng pagpapagaling ay ang mabilis na pag-usbong ng modernong medisina at teknolohiya. Ang hamong ito ay nagdadala ng unti-unting pagbabago sa kulturang etniko ng mga pamayanan na maaaring nagreresulta sa pagkawala nito, o ang tinatawag na ethnocide (Martin et al., 2012). Mahalagang magkaroon pa rin ng kamalayan ukol sa mga katutubong pamamaraan na hindi pa naidodokumento sapagkat ang mga ito ay



repleksyon ng kultura, paniniwala, at tradisyon ng mga Pilipino. Ang mga pag-aaral at pagdodokumento sa ganitong uri ng mga pagpapagaling ay isang mabisang paraan upang mapanatili ang mga ito sa kabila ng modernisasyon.

Isa sa mga mayayamang lugar sa Pilipinas, kung tungkol sa mga katutubong pagpapagaling ang pag-uusapan, ay ang Bundok Banahaw at ang mga karatig na lugar na matatagpuan sa paanan nito. Ang Bundok Banahaw ng Dolores, Quezon ay isang bulkan na matatagpuan sa mga hangganan ng mga lalawigang Laguna at Quezon. Ang paligid ng Banahaw ay kombinasyon ng mga higitang sinaunang puno, luntiang halaman, talon, ilog at kweba. Ang lugar na ito ay isang sagisag ng pasyon ng mga Pilipino para sa espiritwalidad at relihiyon, at sa gayon ay itinuturing ito na “Power Mountain”. Dahil dito, nabigyang-pansin kung paano nagsisimula ang mga pagpapagaling sa pamamagitan nang paglilinis ng parehong katawan at kaluluwa. Ang konsepto ng relihiyon sa Bundok Banahaw ay hindi lamang nakaangkla sa paniniwala, kasanayan, at mga ritwal na isinasagawa ng mga Romano Katoliko. Sa halip, iba’t ibang miyembro ng mga pangkat ng relihiyon at kulto ang dumadayo sa Bundok Banahaw, at ito ay ang mga sumusunod: (1) Ang sekta ng mga Rizalista; (2) Samahan ng Tatlong Persona Solo Diyos (STPSD), isang sekta na itinatag ni Agapito Illustre; (3) Suprema of De la Iglesia Mistica Filipina (SDLIM); at (4) Watawat ng Lahi (Abbang et al., 2016). Sa kabila ng napakaraming mga pag-aaral na naisagawa tungkol sa iba’t ibang paniniwalang nakalukob sa Bundok Banahaw, nananatiling may iba’t ibang paraan ng pagpapagaling sa bundok at mga karatig na lugar ang hindi pa naidodokumento. Isa na rito ay ang magnetic folk healing na isinasagawa sa Barangay Kinabuhayan at Sta. Lucia sa bayan ng Dolores, Quezon.

Ang magnetic folk healing ay isang katutubong pamamaraan na may kakayahang pagalingin ang iba’t ibang uri ng sakit na nararamdaman ng isang pasyente tulad ng pilay, sakit ng ulo, sakit sa tiyan at iba pang mga karamdamang maliban sa mga bukas na sugat. Ang magnetic folk healing ay may iba’t ibang baryasyon depende sa dalubhasa ng manggagamot at kung saang lugar ng katawan ito isinasagawa. Sa kabila ng kaibahan ng mga proseso nito, magkakatulad ang mga ito kung saan hindi idinadampi ang kamay ng magnetic folk healer sa bahagi ng katawan na pinagagaling.

Sa kasalukuyan, wala pang pagtatala o pagdodokumento ang naisasagawa ukol sa magnetic folk healing sa Barangay Sta. Lucia at Kinabuhayan sa Dolores, Quezon. Ang pag-aaral na ito ang magsisilbing kauna-unahang hakbang upang maitala ang nasabing katutubong pamamaraan.

Bilang isang preliminaryong pagtatala, ang pag-aaral na ito ay nakapokus sa kaso ng isang magnetic folk healer na si Ate Mel. Siya ang kaisa-isang manggagamot na dalubhasa sa magnetic folk healing sa Barangay Kinabuhayan at Sta. Lucia na matatagpuan sa Bundok Banahaw. Ang pag-aaral na ito ay magsisilbing batayan ng mga susunod pang pananaliksik na may layuning higit pang pag-aralan ang mga katutubong pamamaraan ng pagpapagaling sa Bundok Banahaw at mga karatig na lugar. Magdaragdag din ang pananaliksik na ito sa mga naisagawa ng pag-aaral tungkol sa Bundok Banahaw, sapagkat ang magnetic folk healing ay nakaugnay sa iba’t ibang mga paniniwala tungkol sa mahiwagang bundok.

Layunin ng pag-aaral na galugarin ang katutubong pamamaraan ng pagpapagaling na magnetic folk healing sa Barangay Kinabuhayan, Dolores, Quezon. Nilalayan nito na matugunan ang mga sumusunod na layunin:

- a. maitala ang paraan ng pagtamo ng kasangkot sa pag-aaral sa kakayahang makapag gamot sa pamamagitan ng magnetic folk healing;
- b. mailarawan ang proseso at mga pamamaraan ng magnetic folk healing; at
- c. mailahad ang mga paniniwala ng kasangkot sa pag-aaral.

2. METODOLOHIYA

Ang case study na ito ay may layuning magtakda ng preliminaryong pagtatala sa magnetic folk healing bilang katutubong pamamaraan ng pagpapagaling sa Barangay Kinabuhayan at Sta. Lucia, Dolores Quezon. Dahil ito ay isang preliminaryong pagtatala pa lamang, inilarawan ng pag-aaral ang iba’t ibang katangian ng magnetic folk healing katulad ng paraan ng pagtamo, ang proseso ng magnetic folk healing; gayundin ang mga naratibong may kaugnayan sa nasabing katutubong pagpapagaling. Ang pag-aaral na ito ay nakapokus sa kaso ni Ate Mel na isang kilalang magnetic folk healer sa Dolores Quezon.

Ang mga datos sa pag-aaral na ito ay kinalap sa pamamagitan ng pakikipagkuwentuhan sa kasangkot sa pag-aaral. Ang mga tanong at gabay na ginamit sa pakikipagkuwentuhan ay sumailalim sa content validity upang matiyak na wasto at sapat ang mga datos na nakalap. Bukod dito, ginamit sa papel na ito ang nakikiugaling pagmamasid upang maidokumento ang proseso ng magnetic folk healing. Sa pagpapahintulot ni Ate Mel at isa sa kanyang mga pasyente, kinuhanan ng larawan ng mga mananaliksik ang bawat mahalalagang hakbang sa

proseso ng magnetic folk healing.

Ang mga kabuuan ng pakikipagkuwentuhan ay sumailalim sa transkripsyon at coding, at ang naprosesong datos ay sinuri sa pamamagitan ng thematic analysis kung saan nakabuo ng tatlong tema ang pag-aaral. Una, ang tema ukol sa paraan ng pagtamo ng kakayahan ng magnetic folk healer. Ikalawa, ang proseso ng pagsasagawa ng magnetic folk healing. Ikatlo, ang mga naratibong nagpapahiwatig ng pagkakaugnay ng magnetic folk healing sa mga paniniwala tungkol sa Bundok Banahaw.

3. RESULTS AND DISCUSSION

Preliminaryong idinokumento ng pag-aaral na ito ang magnetic folk healing bilang katutubong pamamaraan ng pagpapagaling sa Barangay Sta. Lucia at Kinabuhayan sa Dolores Quezon. Hinati sa tatlong bahagi ang pagtatala: ang paraan ng pagtamo, proseso ng magnetic folk healing, at mga naratibo ng kasangkot sa pag-aaral tungkol sa iba't ibang paniniwalang may kaugnayan sa Bundok Banahaw.

3.1. Paraan ng Pagtamo ni Ate Mel ng Magnetic Folk Healing

3.1.1. Bundok Banahaw Bilang Pinagmulan ng Kakayahan

Ang Bundok Banahaw ang nagsilbing ugat ng kakayahang magpagaling ng aming susing kasangkot na si Ate Mel. Ang kanyang kapangyarihan ay unang ipinahayag sa kanya noong siya ay nasa hayskul; sa pagkakataong ito, nagkaroon siya ng matinding sakit sa ulo at hindi siya nakapasok sa eskwelahan. Ayon kay Mercado (1988), may isang ecstatic na elemento na maaaring pagdaanan ng isang manggagamot at sa pagdanas niya nito ay naapektuhan siya ng sakit o minsan ay napagkakamalan na baliw.

3.1.2. Ang Nakakita ng Kanyang Kakayahan sa Santos Kalbaryo

Bukod rito, tuwing huling Sabado ng buwan ay nagno-novena si Ate Mel sa Santos Kalbaryo sa Bundok Banahaw. Mayroon siyang nakasalubong na magdadasal na mayroong third-eye at nakitaan siya ng liwanag sa noo at bukal ng tubig sa kamay. Ang mga ito ay sinasabing palatandaan na mayroon siyang panawagan sa bundok. Subalit walang eksaktong interpretasyon ang liwanag sa noo at bukal ng tubig sa mga kamay na nakita ng magdadasal sa kanya; ngunit ito pa rin ay mayroong matinding ugnayan sa kanyang pagtamo upang matuklasan niya ang kanyang kakayahan.

3.1.3. Mga Panaginip mula sa Bundok Banahaw

Karagdagan dito, noong nag-ibang bansa si Ate Mel, napaginipan niya na tinatawag siya ng Bundok Banahaw at hinihikayat siya na bumalik muli sa Pilipinas. Ang isang holy voice ay napaginipan naman ng banyagang si Fred Pankrast na pumunta sa Pilipinas at tumuloy sa tahanan ng pamilya ni Ate Mel. Isa si Fred sa nakakita ng kanyang kakayahan at nagpayo na ikuskos ang kanyang mga palad upang uminit ito.

Ayon kay Gorospe (1992), mayroong tinataguriang “Santong Boses” ang Bundok Banahaw. Nagpakita ito sa sinaunang historikal na mistiko na si Agripino Lontok. Si Lontok ang nagsilbing kauna-unahang tagapangalaga ng bundok. Bilang karagdagan, si Fr. Vicente Marasigan, isang Jesuit na pari, ay nagkaroon din ng karanasang espiritwal sa kanyang panaginip ukol sa mga nagbubulungang espiritu sa Kinabuhayan. Bagaman walang eksaktong ebidensya na nag-uugnay sa apat na karanasan, lahat ng ito ay nagmula sa Bundok Banahaw. Ayon sa makalumang Pilipinong animistikong kultura, ang isang panaginip ay nagaganap sa paunang yugto ng pagbuklod ng isang manggagamot sa kanyang kakayahan (Mercado, 1988).

3.2. Proseso ng Magnetic Folk Healing

Upang maayos na maisagawa ang magnetic folk healing at epektibong gumaling ang pasyente,



Larawan 1. *Paglagay ng Langis*

mayroon itong pitong hakbang na sinusunod:

Una, naglagay ng langis sa kanyang kamay si Ate Mel. Ginawa niya ito upang mabilisang makuskos ang mga palad para uminit ito. Sinabi ni Ate Mel na kahit anong klase ng langis ay maaaring gamitin, ngunit ang pinakaangkop na langis ay galing sa simbahan.



Larawan 2. *Pagtanggal ng Masamang Enerhiya*

Ikalawa, nagtanggal ng masasamang enerhiya si Ate Mel mula sa ulo, likod, dibdib at tiyan ng pasyente. Nabanggit niya na mula sa mga espiritista niya nakuha ang pagtatanggal ng masasamang enerhiya bago pagalingin ang mga pasyente.

Ika-apat, inilapit ni Ate Mel ang kanyang mga kamay sa buong katawan ng pasyente nang hindi lumalapat sa damit o balat ng pasyente. Mayroong tatlo hanggang apat na pulgadang layo mula sa palad ng manggagamot at balat ng pasyente. Nag-umpisa si Ate Mel mula sa ulo, papunta sa likod at nagsimula na siyang dumighay. Ang pagdighay ay indikasyon na nagiging matagumpay ang isinagawang magnetic folk healing. Matapos sa likod, ang sunod ay ang dibdib papunta sa tiyan.



Larawan 5. *Pagtapat ng Kamay*

Ika-lima, noong natukoy ni Ate Mel ang bahagi ng katawan na mayroong sakit, nanatili siya rito hanggang sa matapos ang kanyang pagdighay. Kapag tumigil nang dumighay si Ate Mel, ito ang indikasyon na wala ng sakit sa katawan ng pasyente.



Larawan 3. *Pagkuskos ng Kamay*

Ikatlo, ikinuskos muli ng manggagamot ang mga palad upang uminit ito.



Larawan 6. *Pagmasahe ng Bahaging May Sakit*

Ika-anim, pagkatapos dumighay ni Ate Mel, kanya naman itong hinawakan na at minasahe.



Larawan 4. *Paglapit ng Kamay*



Larawan 7. Pagdighay ng Manggagamot

At ika-pito, dumighay na si Ate Mel upang ang natanggal na sakit ay hindi manatili sa kanya. Mayroong mga pagkakataon na nararamdaman niyang nanghihina siya, ngunit madalas na hindi.

3.3. Mga Paniniwalang may Kaugnayan sa Bundok Banahaw

Talahanayan 1. Mga Naitalang mga Paniniwala na may Ugnayan sa Bundok Banahaw

Malaki ang impluwensiya ng iba't ibang paniniwala ng mga nakatira sa Bundok Banahaw at karatig na lugar tulad ng Dolores, Quezon sa kanilang pang-araw-araw na pamumuhay. Ang kakayahan ni Ate Mel na magnetic folk healing ay isang palatandaan ng impluwensiyang ito.

Mga Iba't Ibang Paniniwala ni Ate Mel	Deskripsyon
Pamumunvesto	Sa Bundok Banahaw, ang <i>pamumunvesto</i> ay isang karaniwang pagpapahayag ng pagsamba sa relihiyon sa pamamagitan ng pagbibisita at pagdadarasal sa mga <i>pinunestros</i> na <i>tunatunang</i> mga sagradong lugar (Somera, 1986). Ilan sa mga nabanggit ni Ate Mel ay

Mga Pangatlong-uri	<p>ang mga <i>pinunestros</i> ng Santa Lucia, Twin Falls, Kaban ni San Isidro, Santong Jacob, Presentahan, Ina ng Awa, Hugasado, at Santos Kalbaryo.</p> <p>Ayon kay Ate Mel, ang kanyang lolo, tatay at asawa, ay nagkaroon ng mga engkwentro sa mga pangatlong uri tulad ng mga <i>espirtu</i>, <i>duwende</i>, at <i>engkanto</i>, dahil sa kanilang ugnayan sa Bundok Banahaw. Sinabi rin niya na mayroong mga samu't saring klasipikasyon ang mga <i>duwende</i>, ngunit ayon sa kanyang asawa — na siyang nag-itsang nakakakita sa kanila — ay inilarawan niya ang mga ito na mayroong mga malalaking bangka at may iba't ibang kulay tulad ng pula, itim, at puti. Ang mga <i>duwende</i> rin ay tumutulong kay Ate Mel sa paghahalaman at mitsan sila rin ang <i>pinagmumulan</i> ng kanyang enerhiya kapag <i>sumasagawa</i> niya ang magnetic folk healing. Ayon kay Demetrio (1969), ang mga ito ay matagal ng <i>pinaniniwalaan</i> ng mga Pilipino, bago pa man takupin ng mga banwegans bansa at ito ay matagal nang buhay simula noong Povedano (Siglo 16) hanggang sa kasalukuyan. Ayon naman kay Arceta (2020), naniniwala ang mga lokal na peregrino na mayroong mga hindi nakikitang nilalang na tinatag na mga <i>laganood</i>. Sila ay nagbabantay sa ilang mga <i>pinunestros</i> sa Bundok Banahaw at inaalokan ng panalangin upang makuha ang pabor nila.</p>
--------------------	---

<i>Spirit Guide</i>	Nabanggit ni Ate Mel na noong may nangailangan ng tulong niya sa diyip ay mistulang may humaplos sa kanya at sinabihan siyang hawakan ang may sakit. Ito ay maaring <i>spirit guide</i> niya. Ayon kay Mercado (1988), ang mga manggagamot ay mayroong mga <i>spirit guide</i> na tumutulong sa kamila sa pamamagitan ng pagbibigay ng kapangyarihan o payo sa kung anong kailangang gawin.
---------------------	---

4. PAGLALAGOM

Ang pag-aaral na ito ay nagsilbing isang preliminaryong pagtatala sa magnetic folk healing bilang katutubong pamamaraan ng pagpapagaling sa Barangay Sta. Lucia at Kinabuhayan, Dolores, Quezon.

Ipinakita ng pag-aaral ang isang natatanging paraan ng pagpapagaling ng isang pamayanan. Isa itong palatandaan na may mga sistema ng katutubong pamamaraan ng pagpapagaling sa Pilipinas ang naghihintay na maitala. Natuklasan na sa kabila ng pag-usbong ng moderno at maagham na paraan ng pagpapagaling, nananatiling buhay ang ilang mga katutubong paraan ng pagpapagaling ng mga Pilipino na may kaugnayan sa kanilang kultura at paniniwala. Sa konteksto ng pag-aaral na ito, tinalakay na ang pangkalahatang proseso ng magnetic folk healing ay nabuo mula sa paniniwala ng manggagamot gayundin ng mga pasyenteng tumatangkilik nito. Bukod sa manggagamot, mahalaga ang gampanin ng pasyente sa pagsasagawa ng katutubong pamamaraan ng pagpapagaling. Ang mga katutubong pamamaraan ay pagsasalubong at pagsasama ng sistema ng paniniwala ng manggagamot at ng kanyang pasyente. Samakatuwid, ang katutubong pamamaraan ng pagpapagaling ay isang shared at arbitraryong ugnayan sa pagitan ng manggagamot at pasyente.

Iminungkahi ng pag-aaral na ito ang mas malalim pang pag-aaral sa magnetic folk healing partikular sa pagpapalawak ng kasangkot sa pag-aaral. Upang mas maidokumento ang nasabing paraan ng pagpapagaling, kinakailangang palawakin pa ang source o panggagalingan ng datos ng pag-aaral mula sa iba pang magnetic folk healers sa Bundok Banahaw. Mahalaga ring madagdagan ang datos mula sa pananaw ng mga pasyenteng patuloy na tumatangkilik sa magnetic folk healing upang makabuo ng isang komprehensibong paglalarawan sa sistema ng magnetic folk healing.

5. PAGKILALA AT PASASALAMAT

Ang pag-aaral na ito ay hindi magiging posible kung hindi dahil sa patnubay ng ilang mga indibidwal na nagpaabot ng kanilang tulong at kaalaman sa paghanda at pagkumpleto ng pag-aaral na ito. Ang aming pasasalamat ay nakatuon sa mga



sumusunod:

Sa aming tagapagpayo na si G. Jeyson T. Taea na nagsilbing pangunahing gabay sa aming mananaliksik. Nagpapasalamat kami sa kanyang pagbahagi ng kaalaman at nakabubuting pagpuna, at para rin sa kanyang walang tigil na pagsuporta at panghihikayat na makumpleto ang pag-aaral na ito. Isang malaking pribilehiyo at karangalan na magsagawa ng pag-aaral sa ilalim ng kanyang patnubay;

Sunod, kay Ate Mel, ang aming susing kasangkot sa pag-aaral na ito. Kung hindi dahil sa kanyang kusang loob na pagbabahagi ng kanyang kaalaman at ng kanyang kakayahan ukol sa magnetic folk healing ay hindi mabubuo ang pag-aaral na ito; Sunod, kay G. Janeson Miranda, ang aming guro sa Practical Research, na nagturo at gumabay sa aming pagsusulat, pati na rin sa kanyang patnubay sa bawat hakbang ng proseso ng aming pag-aaral;

Sa aming mga kaklase at kaibigan na nanatili sa aming tabi sa buong durasyon ng proseso ng pagsasaliksik at nagbigay ng kanilang walang kapantay na suporta, at tumulak sa amin upang tapusin ang pag-aaral na ito;

At higit sa lahat, sa makapangyarihang Diyos at sa aming mga pamilya na nagsilbing inspirasyon at para sa pagbibigay sa amin ng lakas ng loob na magpatuloy sa kabila ng lahat ng hamon na hinarap ng aming pag-aaral.

6. SANGGUNIAN

Abbang, G. A. G., Acuna, P. G. C., Amparo, L., Bernardo, M. H., Blanco, S., Cabrera, N., Caoli, M., Diaz, K. C., Galang, M. A., Hernandez, S. M. F., Mingming, J., Moll, M., Ramos, B., Sandagan, R. D., Sembrano, K. J., Velasquez, A. L. A., & Zabala, K. N. P. (2015). Pamumuwesto at Mount Banahaw. *Academia.edu*. Retrieved January 16, 2021, from https://www.academia.edu/25758163/Pamumuwesto_at_Mount_Banahaw

Arceta, K. B. (2020). Mount Banahaw's Enigma of Power: A Personal Reflection on Signs and Symbols at the Santa Lucia Complex. *International Journal of Religious Tourism and Pilgrimage*, 8(5), 43-55. Arrow Tudublin. Retrieved February 15, 2021, from <https://arrow.tudublin.ie/ijrtp/vol8/iss5/5/>

Berdon, Z. J. S., Inocian, R. B., Lozano, E. B., & Manalag, C. A. (2016). Unveiling Cebuano Traditional Healing Practices. *Asia Pacific Journal of Multidisciplinary Research*, 4(1), 51-59. ResearchGate. Retrieved January 19, 2020, from www.researchgate.net/publication/299447262_Unveiling_Cebuano_Traditional_Healing_Practices.

Demetrio, F. (1969). The Engkanto Belief: An Essay in Interpretation. *Asian Folklore Studies*, 28(1), 77-90. JSTOR. <https://doi.org/10.2307/1177781>

Esperat, E. L., Gracia, A. A., & Molina, R. A. (2020). TRADITIONAL HEALING PRACTICES IN ZAMBOANGA CITY, PHILIPPINES. *EPRA International Journal of Multidisciplinary Research (IJMR)*, 6(5), 81-97. ResearchGate. 10.36713/epra2013

Gaabucayan, S. (1971). The Medicine Men of Agusan in Mindanao, Philippines. *Asian Folklore Studies*, 30(1), 39-54. JSTOR. <https://doi.org/10.2307/1177763>

Gorospe, V. R. (1992). Mount Banahaw: The Power Mountain From Ritualism to Spirituality. *Philippine Studies*, 40(2), 204-218. JSTOR. Retrieved January 16, 2021, from www.jstor.org/stable/42633309

Jocano, F. L. (1966). Cultural Context of Folk Medicine: Some Philippine Cases. *Philippine Social Review*, 14(1), 40-48. JSTOR. Retrieved February 2, 2021, from <http://www.jstor.org.dlsu.idm.oclc.org/stable/23892728>

Martin, J. G. S., Obal, J. O., & Basitao, C. S. (2012). A Micro-Ethnography of the Dawak: Healing Rituals of the Kalinga. *IAMURE International Journal of Health Education*, 2(1). *Philippine EJournals*. Retrieved January 12, 2020, from <https://ejournals.ph/article.php?id=2824>

McLaughlin, L. A., & Braun, K. L. (1998). Asian and Pacific Islander Cultural Values: Considerations for Health Care Decision Making. *Health & Social Work*, 23(2), 116-126. Oxford Academic. <https://doi.org/10.1093/hsw/23.2.116>

Mercado, L. N. (1990). POWER AND SPIRITUAL DISCIPLINE AMONG PHILIPPINE FOLK HEALERS. *Melanesian Journal of Theology*, 7(1), 63-75. Brill. <https://doi.org/10.1163/157338390X00092>

Somera, R. D. (1986). Pamumuwesto of Mount Banahaw. *Philippine Studies*, 34(4), 436-451. JSTOR. Retrieved January 16, 2021, from www.jstor.org/stable/42632965

Villapa, J. A. (2017, May). KATUTUBONG PANGGAGAMOT NG PANGKAT-ETNIKONG PALAWAN SA BROOKE'S POINT AT BATARAZA, PALAWAN. *Saliksik E-Journal*, 6(1), 57-84. *Philippine EJournals*. Retrieved July 22, 2020, from <https://ejournals.ph/article.php?id=11794>



From Pre-Alpha to Freestyle: Figure Skating Through the Lens of Filipino Figure Skaters

Sofia Ysobel D. Cariño

De La Salle University Integrated School, Biñan City, Laguna

Christian P. Gopez, Research Adviser

De La Salle University Integrated School, Manila

Abstract: Figure skating has been around since 1772 when an Englishman by the name of Robert Jones gave a whole new meaning to the concept of skating on ice, and since then, it has been a sport loved by many around the world. However, despite its long history, many researchers have stated that there is still a paucity of information regarding figure skating. In the Philippines, the dance sport was only introduced in the 1990s; hence, it is a relatively new concept that most researchers have yet to touch on. This study, therefore, aims to analyze figure skating in the Philippines through the lens of Filipino figure skaters. Using a qualitative phenomenological approach, the researcher conducted semi-structured interviews (SSI) with figure skaters and Philippine Skating Union (PHSU) coaches and officials. It was found that the practices which Filipino figure skaters do are the same ones being practiced abroad because as a country new to figure skating, the dance sport does not have much popularity yet which limits the chances of having practices that are uniquely Filipino. Despite this, there are still attempts to adapt foreign concepts to better fit the local skaters. The Filipino identity in figure skating also seems blurred as the respondents have varying perspectives on whether or not their fellow skaters instill a sense of Filipino identity into their routines. It was concluded that the dance sport is still far too young to be able to have an established perspective.

Key Words: figure skating; figure skaters; Filipino identity; dance sport

1. INTRODUCTION

The concept of skating on ice is believed to date as far back as 3000 B.C in Scandinavia (Mayer, 2018). While this remained as a concept for so long, it was finally materialized as a real sport in 1772 when a British artilleryman named Robert Jones coined the term “figure skating”. Later on, he created the first known instructional book, “A Treatise on Skating,” which included tips for beginners and instructions on how to perform certain moves (Hamilton, 2019). Formerly a dance sport with rigid movements, Jackson Haines reimagined its style and incorporated ballet concepts into it in order to transform the dance sport to what it is known for now—graceful and flowing (“Jackson Haines”, 2021).

Despite figure skating having an extensive history, it still comes as a surprise that there are barely any studies regarding the dance sport around the world. According to Grau in 2010, “dance scholars with a few exceptions rarely write about figure skating.” This statement has been backed up by many other researchers who share the same sentiments that there is indeed a “lack of systematic research” in the field of figure skating (Niinimaa, 2017). Taking things to a more local context, the dance sport of figure

skating is still very new in the Philippines. It only started in the country during the 1990s when the first ice skating rink in the Philippines was built in SM Megamall (Philippine Skating Union, n.d). This is likely due to the fact that winter sports are not as popular in tropical countries as it is in winter countries. In addition, the sport slowly started gaining attention from the masses during the early 2000s. Since then, the sport has been rather successful in producing high-level skaters including Michael Martinez who was the first-ever skater to represent South East Asia in the Olympics. However, this is no comparison to countries with decades of experience and the appropriate climate for this sport. Thus, it is no wonder that there are almost no known studies about figure skating made in the Philippines, much less the Filipino perspective of figure skating.

Therefore, this study will look into figure skating through the lens of Filipino figure skaters and coaches. It will specifically aim to answer the following research questions:

1. What are the practices of Filipino figure skaters that make them uniquely Filipino?
2. How does the Philippines adapt figure skating into its own context?



3. How do Filipino figure skaters instill a sense of Filipino identity into their figure skating routine?

2. METHODOLOGY

This research employed a qualitative phenomenological approach to describe figure skating through the lens of Filipino figure skaters and used a purposive sampling technique to identify key informants. The informants of this study are figure skaters ages 16 and above who train, compete, and represent the Philippines in local and/or international competitions for at least three years. The researcher also interviewed coaches and officials from the Philippine Skating Union (PHSU), the official governing body for figure skating and speed skating in the Philippines, to gain more insight regarding the study. A total of six figure skaters and four PHSU coaches or officials were interviewed.

An in-depth interview guide was used to conduct Semi-Structured Interviews (SSI), which covered topics such as: adapting foreign concepts, practices figure skaters do which are uniquely Filipino, challenges they face when training in the Philippines, their perception about Philippine figure skating in general, and lastly, their insights regarding the Filipino identity in figure skating. Interviews were conducted via Zoom and were recorded with the informants' consent. Most of the informants were of legal age; hence only an Informed Consent Form (ICF) was needed; however, for the minors, a Parental Consent Form was given.

Data were analyzed using thematic analysis. The researcher coded the data to highlight significant themes from the transcript and pseudonyms were assigned to each informant as Coach A-D and Skater A-F. Bruner's Narrative Theory was also utilized in data analysis which allows for more focus on important narratives and how these aid in understanding the stories and experiences of the key informants.

3. RESULTS AND DISCUSSION

3.1 Figure Skating Through the Lens of Filipino Figure Skaters

Figure skating is considered a foreign dance sport in the Philippines, likely due to the fact it is difficult to appreciate winter sports in a tropical country. However, in recent times, figure skating has built quite a following in the country. Because of this development, it is important to explore practices that figure skaters and coaches observe that are uniquely Filipino. Based on initial findings, Filipino figure skaters observe standard practices being done abroad,

specifically training regimens, movements, and other practices that are followed in the international scene. Localizing foreign practices is not easy; Coach D believes that the Philippines does not adapt nor even attempt to adapt foreign concepts into its own context, likely because the sport does not enjoy mainstream popularity yet. However, it is hoped that figure skating can be fully developed in a more localized context. Coach A states that, at times, coaches adapt training programs practiced abroad and adjust the same to better fit the needs of Filipino figure skaters. He also mentioned the need to incorporate Filipino themes into figure skating routines: "It's time for us to use more Filipino music into our programs. It's about time we introduce Filipino music and Filipino movements into the international scene."

Both the coaches and the skaters expressed that aside from challenges in localizing figure skating, they have encountered other issues that hinder the growth of the dance sport in the country. These issues include lack of funding, training equipment, support, facilities, and overall public interest and awareness. High costs and inadequate training programs are also of great concern. Among all the issues above mentioned, it is the lack of public interest and funding that seem to be the most critical matters that need to be focused on. Skater D stated, "I don't know if *mababa kasi 'yung demand* [of skating rinks]...or *wala kasing skating rink kaya mababa 'yung demand ng skaters*." He further explains that the advancement of figure skating is hindered because of the limited local talent pool. Additionally, coaches remarked that stigmas relating to figure skating being an elitist sport likewise contribute to the low public interest. According to the Philippine Statistics Authority (PSA), the average annual income for Filipino families as of 2018 is P313,000. With coaching sessions amounting to around P9,000 an hour, this sport is definitely not affordable for the average Filipino family. When asked about the challenges faced in the promotion of figure skating, coaches mentioned how difficult it is to ask for funding. It was discussed at length how figure skating in the Philippines operates like a business under SM Management, one of the biggest mall developers across South East Asia. Coach C discusses how SM Management's primary objective is to attract the masses: "The ice skating rink in SM is there to attract customers, it's not there to train Olympians... *kaya* when you ask the management for budget, *mahirap, kasi mahal*." He elaborates that since the main source of income comes from the public who skates for recreational purposes, lesser customers mean lesser income— therefore, lesser budget.

Inadequate funds logically lead to a lack of proper training equipment and facilities. Some national team skaters still feel the need to train abroad or seek out foreign coaches to search for better



opportunities that they cannot find in the country. However, Skater D believes that all figure skaters will eventually seek foreign coaches and opportunities abroad as they advance in the sport. She points out that even Yuzuru Hanyu, a very successful Japanese figure skater, still trains abroad in order to widen his perspective and experience. She sums everything up by saying, “I think the training environment means a lot to your training.”

Conversely, other figure skaters train abroad solely as a result of the lack of opportunities in the Philippines. Skater E introduces the idea that coaches in the Philippines are not as advanced compared to other countries. If one wishes to advance their training, they will need to go abroad because the expertise of the local coaches is limited up to a certain level only due to lack of exposure and training for them. She admits that though these coaches are good, she does not believe that they will be able to offer quality training for higher-level techniques as they are not equipped with the required knowledge and expertise to do so.

Ultimately, figure skating in the Philippines is currently in the early stages of its development, and thus, there still are several challenges that need to be addressed and prioritized. While there are attempts to adapt figure skating into a more local context, it is not easy to achieve due to the various issues discussed above.

3.2 The Filipino Identity in Figure Skating

It is difficult to instill the Filipino identity into the skating routines of Filipino figure skating students when the local sports management limits the use of Filipino music. Coach C mentioned that SM not only discourages skaters from using Filipino songs for their programs, but also discourages that these songs be played during public hours in the rink. For this reason, figure skaters who want to incorporate Filipino themes into their programs cannot do so, while some disregard the idea entirely because of the difficulties in gaining permission to use Filipino songs. Coach C also declared, “Our generation [in the '90s] used to skate to Filipino songs but it is not practiced now, or it is frowned upon because it does not follow the brand of SM Lifestyle as a mall,” further stating how Filipino figure skaters have much potential in exploring their creativity should they be allowed to skate to that type of music.

Moreover, when asked if incorporating Filipino dance movements into figure skating was possible, the informants had varying opinions. Some agreed and explained how versatile Filipino movements are, noting it was entirely possible to incorporate them into figure skating. It was also stated that using Filipino music would likewise

greatly contribute to introducing the Filipino culture to the international community as well. Coach B says, “One thing I love about figure skating is you can be whatever you want to be.” Figure skaters agreed to this statement by explaining how the innate grace and artistry Filipinos have would translate well if Filipino movements were incorporated into figure skating routines.

In contrast, other informants disagreed with the possibility of incorporating Filipino movements and themes into figure skating because they labeled it as a risk. When competing, it is important that the judges are familiar with the music to allow them to focus more on scoring the performance. Coach D mentioned that using Filipino themes introduce a very unknown concept to the judges, making them focus more on getting acquainted with the theme rather than paying attention to the performance itself. Skater D supported this by narrating how judges want to see a skater’s personal touch to the music. Using Filipino themes will result in the judges focusing more on understanding the chosen theme instead of connecting with the skater. Coach A countered this argument, though, by arguing that judges are already proficient in understanding music; thus the use of Filipino themes should not be seen as a risk to prevent its use.

Finally, many figure skaters agreed to incorporate a sense of Filipino identity into their craft. They elucidated how their identity is present when competing abroad and how they carry themselves before an international audience. Skater C states, “when Filipinos compete abroad, you can really tell by their personality and how they carry themselves that they are Filipino.” Not all share this view, though; Skater D, in particular, commented, “*Parang hindi naman, kasi* even other skaters, they don’t really have their natural identity into their programs.” He ends by saying how there is no national identity in figure skating and that it is hard to incorporate it into the sport.

In retrospect, the presence of Filipino identity in figure skating is still blurred, as seen in the varying opinions stated above. In addition, Philippine figure skating is still largely based on international standards and practices. Many of the competitions that skaters compete in are also done abroad which is why there is a tendency to follow more international standards and themes.

4. CONCLUSION

In summary, figure skating in the Philippines is far too young for it to have an established Filipino perspective. The community does not have practices that can be identified as uniquely Filipino since Filipino skaters seem to adopt international practices rather than localizing the



same. More so, evolving uniquely local concepts proves to be a big challenge because, while there are small steps taken to somehow adapt foreign concepts, the notion of using Filipino themes in international competitions is still labeled as a risk. Notably, the Filipino identity in figure skating seems blurred as the informants have differing perspectives on whether or not skaters incorporate it into their routines. Ultimately, only when all challenges have been addressed can the Filipino perspective in figure skating be fully realized.

Philippine Statistics Authority. (July 31, 2018). Income and Expenditure. <https://psa.gov.ph/survey/annual-poverty-indicator>

5. ACKNOWLEDGEMENTS

This research would not be possible if not for the continuous support of family and friends who have been a source of encouragement while completing this research paper. Special thanks to my research adviser, Mr. Christian P. Gopez, who has offered his continuous guidance, wisdom, and patience throughout the completion of this paper. I would also like to extend my sincerest gratitude to all research mentors who have helped in honing my abilities in academic writing.

Thank you to De La Salle University, which has provided me with this opportunity and platform to share my research and be able to spread more knowledge about figure skating in the Philippines.

And lastly, I would like to thank all the figure skaters and coaches alike who shared all their experiences in Philippines figure skating. This research would not be possible if not for your support, especially to Ms. Celene Grace, who helped me build connections in the figure skating community.

I would like to dedicate this research to all the Filipino figure skaters and coaches, and to the figure skating community in the Philippines. This research is meant to spread more awareness and information about this beautiful dance sport in the country. To the Filipino figure skating community, this study I offer to you.

6. REFERENCES

- Britannica, T. Editors of Encyclopaedia (2021, January 1). Jackson Haines. Encyclopedia Britannica. <https://www.britannica.com/biography/Jackson-Haines>
- Grau, A. (2010). Figure Skating and the Anthropology of Dance: The Case of Oksana Domnina and Maxim Shabalin. https://www.academia.edu/413857/Figure_Skating_and_the_Anthropology_of_Dance_The_Case_of_Oksana_Domnina_and_Maxim_Shabalin
- Hamilton, S. (2019, May 13). Figure skating. Encyclopedia Britannica. <https://www.britannica.com/sports/figure-skating>
- Niinimaa, V. (December 18, 2017). Figure Skating: What Do We Know About It?. <https://www.tandfonline.com/doi/abs/10.1080/00913847.1982.11947146>



Forecasting Road Traffic Accidents in the Socioeconomic Context

Ervin Raphael R. Alba, Trevor Jalen O. Chua, and Johannes Nathan C. Hong
De La Salle University Integrated School, Manila

Shirlee R. Ocampo, *Research Adviser*
De La Salle University, Manila

Abstract: Road traffic accidents not only take lives, but they also have a vast impact on the economy of the nation. This study aims to provide the appropriate agencies with statistical models of road traffic accidents and the most prevalent causes of motorcycle accidents. To achieve that, the researchers applied certain statistical procedures such as the Moving Average, Weighted Moving Average, Exponential Weighted Moving Average, Chi Square Test of Multiple Proportions, ARIMA Modelling, and Measures of Forecasting Accuracy. These were conducted through softwares like Microsoft Excel and SAS. The researchers identified the most accurate model to be the 6-month Exponential Weighted Moving Average and used it for forecasting. The forecast showed that by the end of 2021, road accidents would have increased from the end of 2019. However, the researchers are aware that the forecast may be inaccurate as more people are impelled to stay at home with the ongoing pandemic; therefore, road accidents have lessened. Despite the reduced economic impact due to road accidents, the Asian Development Bank estimates that the pandemic will deter the GDP growth of the nation by 10%. Furthermore, with the data available, the researchers identified human error to be the prevalent cause of road traffic accidents. However, no known causation factor “No Accident Factor” comprised 99% of the data, thus the researchers highly recommend the Philippine National Police and Metropolitan Manila Development Authority to thoroughly investigate road traffic accidents to identify their cause in order for engineers and road safety practitioners to resolve them.

Key Words: road traffic accidents, accident modeling, road safety, ARIMA, socioeconomic impact

1. INTRODUCTION

1.1. Background of the Study

In 2017, road traffic accidents were the fourth leading cause of death in the Philippines. A report by the Philippine Statistics Authority in 2016 showed that there were 582,123 deaths reported in motorcycle accidents. With the recent prevalence of motorcycle taxis, this number is likely to increase in the coming years. A study conducted by Lam et al. (2018), which involved model estimates of road traffic accidents in the Philippines during 2014, showed that the projected number of deaths and injuries was equivalent to a direct medical cost of 1.213 billion pesos. Moreover, the cost in productivity loss due to death and serious injury resulted in ₱24.62B and ₱685M, respectively. Another article by the World Health Organization (WHO) suggests that road crashes cost \$518B annually on a global scale and affect 1-2% of the gross national product of countries. This study also added the importance of awareness towards estimating the volume of road accidents along

with its expenditures in order to create cost-effective measurements to further prevent such disasters and ensure safety.

Accident prediction models help road safety practitioners assess the causes of road accidents; together with engineers, they may help reduce road accidents by devising safety features. Abdulhafedh in 2017 indicated that accident prediction models have helped determine the crash frequency and severity of such crashes. This data has helped transportation agencies, health care facilities, and research institutions to identify the most dangerous roads.

1.2 Research Objectives

In relation to the circumstances of road safety in the Philippines, this research has the following objectives:

- a) To determine the most prevalent causes of motorcycle road accidents in Metro Manila for the year 2019;



- b) To forecast the number of road traffic accidents in Metro Manila for 2020 and 2021; and
- c) To generate a statistical model of road accidents in Metropolitan Manila for the years 2010-2019.

1.3 Scope and Limitations

This study covers the road accidents that occurred in Metropolitan Manila for the years 2010-2019 only. This research may not accurately determine certain factors as the data is left for the researchers to interpret and rely on information provided by the Metropolitan Manila Development Authority (MMDA); the data provided by the said agency may not be tampered with by the researchers.

1.4 Significance of the Study

As cars increase, so do road traffic accidents. This study would help the LTO, MMDA, and other related agencies to improve road safety features needed in Metropolitan Manila to reduce road accidents. Moreover, proper authorities such as the MMDA and LTO would take action to possibly reduce road accidents in the future. Furthermore, this study can inform the general public to be cautious. All these contribute to lessening road accidents and, in turn, lessen the economic losses of the nation.

2. METHODOLOGY

2.1 Data Collection Method

The data for this study was acquired from the MMDA via the Freedom of Information website. The data request thread may be accessed through this link: <https://www.foi.gov.ph/requests/aglzfmVmb2ktcGhyHgsSB0NvbnRlbnQiEU1NREEtMjk0NTQ4MTA1MTY2DA>.

2.2 Data

The data set received had complete monthly data points from 2010 to 2019 and was categorized as Damage to Property, Fatal, and Non-fatal Injuries. MMDA also provided data containing the causes of motorcycle accidents for 2019 based on police blotter books; however, some accidents have no determined cause of the accident. The determined causes of accidents are classified as human error, mechanical defect, vehicle defect among others (see Appendix A for complete details).

In forecasting the number of accidents for the year 2020 to 2021, the researchers divided the data set from 2010-2019. The analysis data used to build the model is the monthly data from the years 2010-2017, while the data used to test the model for errors is the monthly data from 2018-2019. Ninety-six data points

(80%) are used for the analysis data, while 24 (20%) are used for the test data.

2.3 Research Procedure

2.3.1 Chi-Square Test with Multiple Proportions

This study utilized a chi-square test to determine the presence of significant differences in the proportions of the significant causes with respect to the number of accidents. The purpose of chi-square testing is to assess the distribution of responses to the discrete outcome variable from each of the independent comparison groups (LaMorte, 2016). The null hypothesis is where all proportions obtained are equal, whereas the alternative hypothesis indicates that not all proportions are equal.

2.3.2 Moving Average

A moving average is a statistical technique that creates a series of averages in a given data set in order to analyze selected data points; thus, this technique is also suitable for forecasting trends. Salkind in 2007 said that moving averages assume that a future value will equal to an average of past values. In a Simple Moving Average (SMA), the mean is calculated without any weighted data n. The equation for SMA is as follows:

$$SMA(n) : F_t = \frac{A_{t-1} + A_{t-2} + \dots + A_{t-n}}{n}$$

where

- Ft = forecasted value
- At = actual value in period t
- n = number of time periods

In a Weighted Moving Average (WMA), weights are implemented such that more recent data points are given more significance compared to previous data. Weights are freely assigned to the data with the rule that the sum of the weights utilized must equate to 1. WMA has the equation:

$$WMA(n) : F_t = W_{t-1}A_{t-1} + W_{t-2}A_{t-2} + \dots + W_{t-n}A_{t-n}$$

where

- Ft = forecasted value
- Wt = weight assigned to period t
- At = actual value in period t
- n = number of time periods

$$\text{and } \sum_{i=1}^n W_{t-i} = 1$$

Exponential Weighted Moving Average (EWMA) is a variation of WMA used in smoothing a data set by calculating for the exponential mean of the previously measured data. Similar to WMA, it involves placing more weight $0 \leq w \leq 1$ on more recent data points while giving a forgetting weighting factor

$(1 - w)$ to data points more distant in the past. The formula for obtaining the EWMA is shown below:

$$Z(t) = [w \times X(t)] + [(1 - w) \times Z(t - 1)]$$

where

$Z(t)$ = EWMA at time t

$X(t)$ = actual data point at time t

w = degree of weighting parameter, $0 \leq w \leq 1$

2.3.3 ARIMA

The researchers also conducted autoregressive integrated moving average (ARIMA) in forecasting road accidents since it complemented the creation of a time series model using autocorrelation analysis, taking into consideration temporal observations. The modeling process followed the Box and Jenkins method, which comprises four stages — identification, estimation, diagnostics checking, and forecasting (Avuglah et al., 2014). The identification stage was used to determine stationarity of the model. Differencing the series was conducted if not. The next step was to identify the orders of the autoregressive (AR) and moving average (MA) terms. After such, estimation was performed to determine the least mean squared deviations in order to test if the model is fit so that the forecasting process may be applied.

This study utilized the ARIMA(p,d,q) model where:

p is the number of lag observations included in the model (lag order);

d is the number of times that the raw observations are differenced (degree of differencing);

q is the size of the moving average window (order of moving average).

2.3.4 Measures of Forecasting Accuracy

The Mean Squared Errors (MSE) and the Mean Average Percentage Error (MAPE) were conducted to evaluate the models for any errors and accuracy. MSE has the equation:

$$MSE = \sum_{t=1}^T \frac{(Y_t - \hat{Y}_t)^2}{Y_t}$$

where

Y_t = Actual value

\hat{Y}_t = Forecasted value

MAPE has the equation:

$$MAPE = \frac{100}{T} \sum_{t=1}^T \left| \frac{Y_t - \hat{Y}_t}{Y_t} \right|$$

where

Y_t = Actual value

\hat{Y}_t = Forecasted value

3. RESULTS AND DISCUSSIONS

3.1 Moving Average

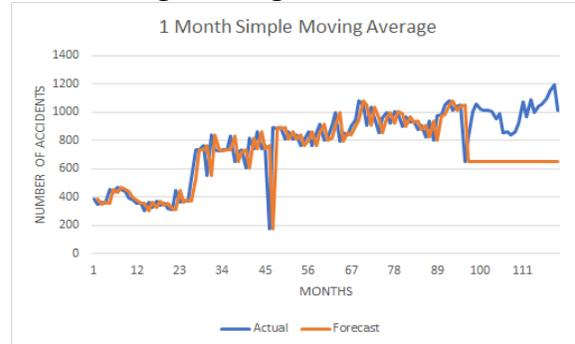

Figure 3.1.1 1-Month Simple Moving Average 2010 to 2019

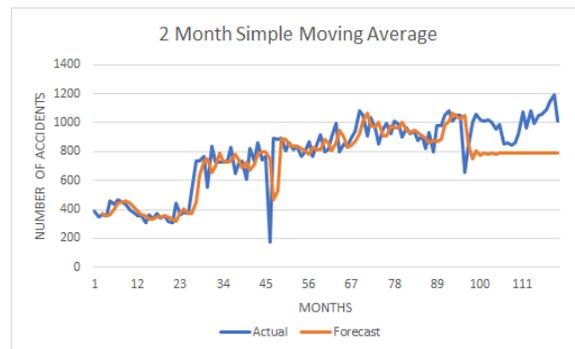

Figure 3.1.2. 2-Month Simple Moving Average 2010 to 2019

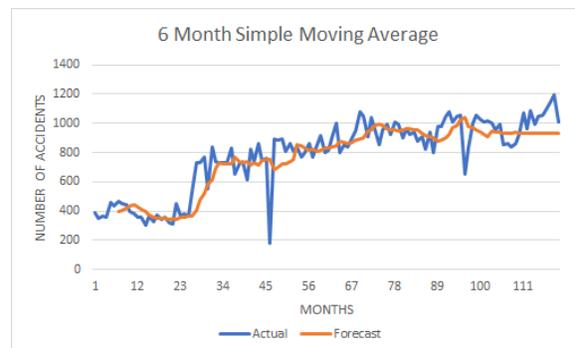

Figure 3.1.3. 6-Month Simple Moving Average 2010 to 2019

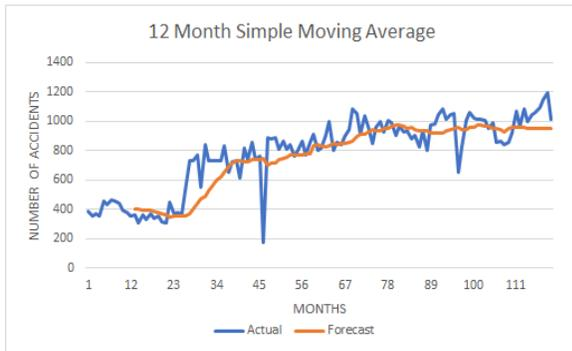

Figure 3.1.4. *12-Month Simple Moving Average 2010 to 2019*

It is observed from all the moving averages constructed, even in the following different moving averages, that the forecasted values appear to flatten starting from the data point of 2018. This is caused by the reliance of the moving average on past values for their current value as Salkind in 2007 stated.

3.2 Weighted Moving Average

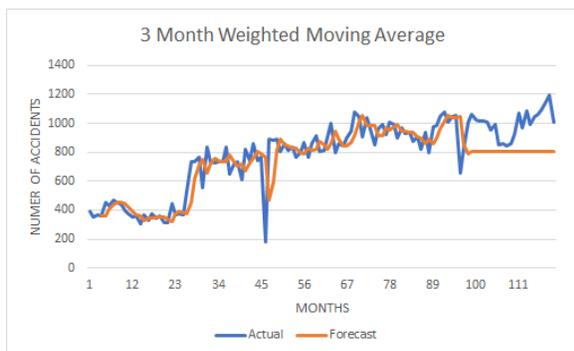

Figure 3.2.1. *3-Month Weighted Moving Average 2010 to 2019*

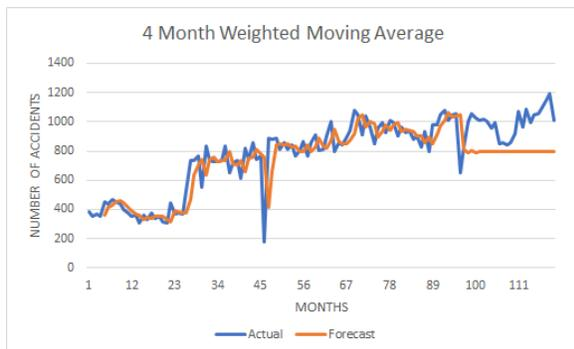

Figure 3.2.2. *4-Month Weighted Moving Average 2010 to 2019*

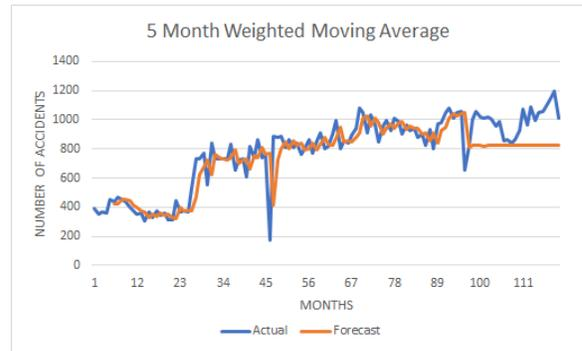

Figure 3.2.3. *5-Month Weighted Moving Average 2010 to 2019*

The flattening of the forecasted data points from 2018 can still be observed. However, the WMA tends to stay flattened even with the increasing months being applied. This is because of the weights assigned in the MA, compounding the averages calculated, and prevents even a slight change in the forecasted value.

3.3. Exponential Weighted Moving Average

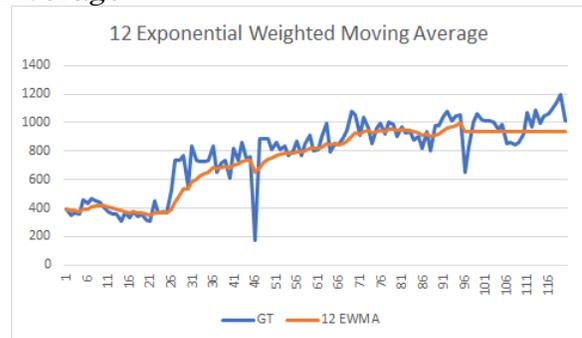

Figure 3.3.1. *12-Month Exponential Weighted Moving Average 2010 to 2019*

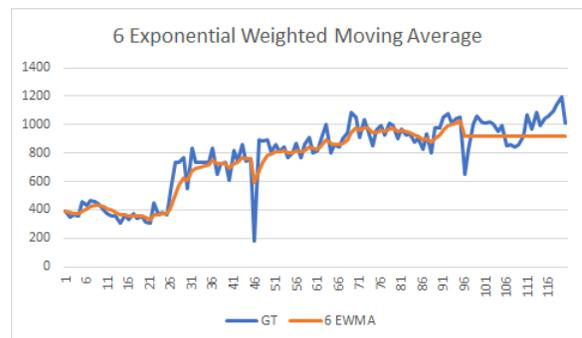

Figure 3.3.2. *6-Month Exponential Weighted Moving Average 2010 to 2019*

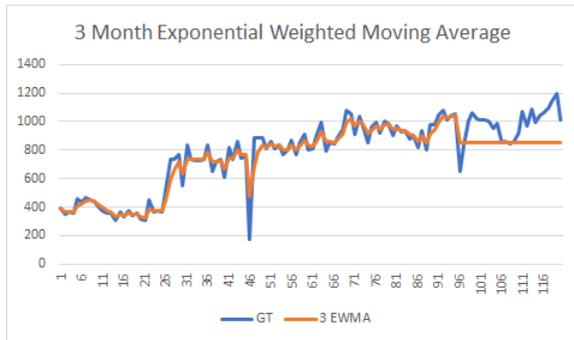

Figure 3.3.3. *3-Month Exponential Weighted Moving Average 2010 to 2019*

Similar to the previous moving averages, the forecasted data flattens after a few data points from the last known data point due to their dependency on the past values.

3.4 ARIMA

Based on the graphs of the grand total, it is visually evident that the data is not stationary. With that, the researchers differenced the data by one degree. The Augmented Dickey-Fuller Test yielded a p-value of less than 0.01%; therefore, the null hypothesis that a unit root exists is rejected; ergo, the data is stationary (see Appendix B). Furthermore, the researchers utilized the autocorrelation function (ACF), showing how the present data is affected by q lags in time of data, and partial autocorrelation function (PACF), explaining the correlation between the series and its lags denoted by p, to determine the autoregressive and moving average order appropriate for the forecast.

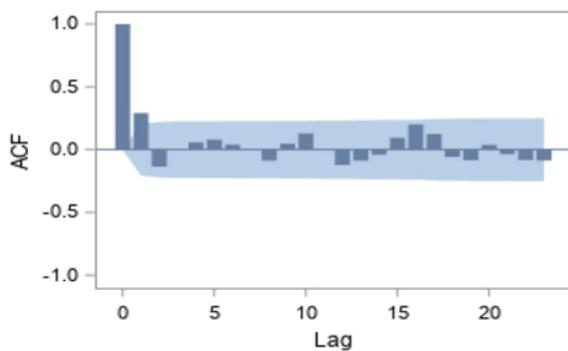

Figure 3.4.1. *Autocorrelation Function (ACF) Plot*

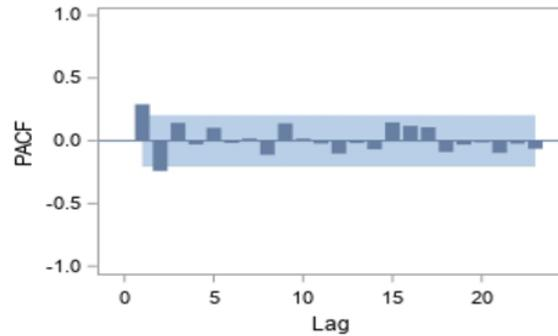

Figure 3.4.2. *Partial Autocorrelation Function (PACF) Plot*

Based on the plots formed by SAS, the ACF plot cuts off after the 1st lag indicating 1st order moving average. Meanwhile, the PACF plot shows gradual decay which indicates that the most fitting autoregressive order is 0. With the gathered data, the ARIMA model for the forecast is ARIMA (0,1,1).

Table 3.4.2. *ARIMA Test Forecast*

Month	Forecast	Actual Value	Squared Error	Percentage Error
August 2019	709	1059	122500	49.36530324
September 2019	712	1093	145161	53.51123596
October 2019	714	1147	187489	60.6442577
November 2019	717	1196	229441	66.80613668
December 2019	720	1010	84100	40.27777778
	MSE	102546.6	MAPE	44.7168%

Table 3.4.2 (see Appendix C for full table) shows the forecasted values compared to the actual values. The MSE and MAPE of the data are 102546.6 and 44.7168%, respectively.

3.5 Measures of Forecasting Accuracy

The researchers determined that the most fitting models to be used for each method are the 6-month MA, 5-month WMA, 6-month EWMA as they had the smallest MAPE value for each of their methods (See Appendix D). Meanwhile, the ARIMA had a MAPE of 44.72%.



3.6 Chi-Square Testing of Multiple Proportions

Table 3.6. Chi-Square Results

Accident Causation	Observed	Expected	χ^2
Human Error	76	39.3	34.27201
Non-human Error	10	39.3	21.84453
DUI	32	39.3	1.35598
Critical Value:	5.991		χ^2 : 57.47252

The data that the researchers received was the accident causation factors for 2019 Motorcycle-related accidents. 99% of the data were “No Accident Factor”, meaning that the police blotter book did not have any recorded cause of the accident. The researchers excluded this data for the test as this tips the scale highly. The researchers also merged the vehicle defect, mechanical defect, and “other” factors as they had the same classification — beyond the driver’s control; this is labeled as “Non-human Error”.

Based on the χ^2 value yielded from this, there is a significant difference between the accident causation factors. The human error appears to be the most significant factor. This includes drivers falling asleep and losing control of their vehicles.

3.7 Forecast

Table 3.7. Forecasted Data

Month	6-month MA	5-month WMA	6-month EWMA	ARIMA(0,1,1)
August 2021	1099	1074	1080	1115
September 2021	1099	1074	1080	1120
October 2021	1099	1074	1080	1125
November 2021	1099	1074	1080	1130
December 2021	1099	1074	1080	1135
% difference from 2019	+8.81%	+6.34%	+6.93%	+12.38%

As seen in the table above (See Appendix E-I for complete details), all models indicate an increase by the end of 2021 from the data as of December 2019. This may be attributed to the fact that there is a yearly increase in the number of cars purchased and on the road. Unless proper action is taken, the forecast is bound to continue on an uptrend.

4. CONCLUSION

With the increase in road accidents, the increase in the nation’s economic loss due to road traffic accidents is bound to increase, similar to the study by Lam et al. in 2018 has stated. However, the researchers are well aware that the forecast may be

inaccurate for 2020 and 2021. As lockdowns continue to ensue, more people are impelled to stay at home; therefore, road accidents have lessened. Despite the reduced economic impact due to road accidents for the years 2020-2021, the Asian Development Bank estimates that the pandemic will deter the GDP growth of the nation by 10% for 2020 and 2021 (De Vera, 2020).

From the methods applied, the least MAPE was the 6-month EWMA at 10.33%. This percentage error is considered acceptable given the context of forecasting; however, the researchers recommend using ARIMAX and other forecasting techniques. Furthermore, the researchers suggest that future studies include studying correlations of factors that contribute to road accidents, such as the number of cars on the road.

Moreover, the MMDA, along with the Philippine National Police, have to investigate road accidents thoroughly as the number of “No Accident Factor” comprised 99% of the data, making it hard for researchers as well as road safety practitioners to identify the cause of accidents for them to be prevented. Furthermore, motorists have to be more cautious as this study has found that the leading cause of motorcycle accidents are due to human error; therefore, the strict implementation of the Anti-Distracted Driving Act of 2016 is highly recommended by the researchers.

5. ACKNOWLEDGEMENTS

The researchers would like to thank their adviser, Mrs. Shirlee Ocampo. Without her advice and guidance, the researchers would not have been able to accomplish the research. The researchers would also like to thank the Metropolitan Manila Development Authority for providing the data used.

6. REFERENCES

Abdulhafedh, A. (2017). Road Crash Prediction Models: Different Statistical Modeling Approaches. *Journal of Transportation Technologies*, 07, 190-205. <https://doi.org/10.4236/jtts.2017.72014>

Avuglah, R.K., Adu-Poku K. A., & Harris E. (2014). Application of ARIMA Models to Road Traffic Accident Cases in Ghana. *International Journal of Statistics and Applications* 2014, 4(5): 233-239. <https://doi.org/10.5923/j.statistics.20140405.03>

De Vera, B. O. (2020). PH pandemic losses to breach 10% of GDP in 2020, 2021. *Philippine Daily Inquirer*. <https://business.inquirer.net/312839/adb-ph-pandemic-losses-to-breach-10-of-gdp-in-2020-2021>

Lam, H. Y., Rivera, A. S., Macalino, J. U., Quebral, J. D., Cheng, K. J. G., & Miguel, R. T. D. P. (2018). Estimating the Social and Economic Burden of Road Traffic Injuries in the Philippines. *Acta Medica Philippina* 52(3). <https://doi.org/10.47895/amp.v52i5.313>

LaMorte, W. W. (2016). “Hypothesis Testing - Chi-Square Test”. Boston University School of Public Health.



https://sphweb.bumc.bu.edu/otlt/MPH-Modules/BS/BS704_HypothesisTesting-ChiSquare/BS704_HypothesisTesting-ChiSquare3.html

Metropolitan Manila Development Authority. (2019). Metro Manila Accident Reporting and Analysis System 2019. http://www.mmda.gov.ph/images/Home/FOI/MMARAS/MMARAS_Annual_Report_2019.pdf

World Health Organization. (2006). Magnitude and impact of road traffic injuries. https://www.who.int/violence_injury_prevention/road_traffic/activities/roadsafety_training_manual_unit_1.pdf

Centers for Disease Control and Prevention (2021, January 5). Test for Past Infection. <https://www.cdc.gov/coronavirus/2019-ncov/testing/serology-overview.html>

Donthu, N., & Gustafsson, A. (2020, June 9). Effects of COVID-19 on business and research. Journal of Business Research. <https://www.sciencedirect.com/science/article/pii/S0148296320303830>.

7. APPENDICES

Table 2.2. Variables and Descriptions (Appendix A)

Variable	Description
Year	The year that the data represents.
Time	The timeframe of each month in each year.
Damage to Property	Number of accidents which only damaged properties.
Fatal	Number of accidents which resulted in death.
Non-fatal Injuries	Number of accidents that inflicted non-fatal injuries to the victims.
Grand Total	Summation of the three types of accidents monthly.
Human Error	Number of accidents wherein the cause of the accident is the driver's fault (i.e., fell asleep, lost control)
Mechanical Defect	Number of accidents wherein the cause of the accident is due to faulty system of the engine (i.e., electrical problem, loose brake)
Other	Number of accidents wherein the cause of the accident may be associated with the environmental factors.
Under the Influence of Liquor	Number of accidents wherein the cause of the accident is due to the driver driving under the influence of alcohol
Vehicle Defect	Number of accidents wherein the cause of the accident is due to a malfunction in the vehicle (i.e. exploded or flat tire)
No Accident Factor	Number of accidents wherein the cause of the accident was not determined by the police.

Table 3.4.1. Augmented Dickey-Fuller Test (Appendix B)

Augmented Dickey-Fuller Unit Root Tests						
Type	Lags	Rho	Pr < Rho	Tau	Pr < Tau	F Pr > F
Zero Mean	0	-140.037	0.0001	-15.48	<.0001	
	1	-199.207	0.0001	-9.27	<.0001	
	2	-731.986	0.0001	-7.94	<.0001	
Single Mean	0	-140.303	0.0001	-15.43	<.0001	119.07 0.0010
	1	-202.704	0.0001	-9.26	<.0001	42.96 0.0010
	2	-875.370	0.0001	-7.98	<.0001	31.92 0.0010
Trend	0	-140.313	0.0001	-15.38	<.0001	118.56 0.0010
	1	-202.988	0.0001	-9.25	<.0001	42.94 0.0010
	2	-894.188	0.0001	-7.98	<.0001	32.05 0.0010

Table 3.4.2. ARIMA Forecast (Appendix C)

Month	Forecast	Actual Value	Squared Error	Percentage Error
97	656	828	29584	26.2195122
98	659	1005	119716	52.50379363
99	661	1059	158404	60.2118003
100	664	1022	128164	53.91566265
101	667	1013	119716	51.87406297
102	670	1016	119716	51.64179104
103	673	1005	110224	49.33135215
104	675	953	77284	41.18518519
105	678	991	97969	46.16519174
106	681	853	29584	25.25697504
107	684	861	31329	25.87719298
108	686	842	24336	22.74052478
109	689	860	29241	24.81857765
110	692	922	52900	33.23699422
111	695	1072	142129	54.24460432
112	698	967	72361	38.53868195
113	700	1085	148225	55
114	703	995	85264	41.53627312
115	706	1047	116281	48.30028329
116	709	1059	122500	49.36530324
117	712	1093	145161	53.51123596
118	714	1147	187489	60.6442577
119	717	1196	229441	66.80613668
120	720	1010	84100	40.27777778
	MSE	102546.6	MAPE	44.7168%

Table 3.5. Measures of Forecasting Accuracy (Appendix D)



	MSE	MAPE
2-month SMA	22330.29	14.44%
6-month SMA	14377.57	12.99%
12-month SMA	16638.45	14.08%
3-month WMA	20890.69	14.76%
4-month WMA	21888.70	14.94%
5-month WMA	19720.10	14.48%
1-month EWMA	126541.21	33.82%
3-month EWMA	30541.30	14.23%
6-month EWMA	14943.52002	10.33%
12-month EWMA	14924.23738	10.61%

Table 3.7.1. 2020-2021 Forecast Summary (Appendix E)

Month	6-month MA	5-month WMA	6-month EWMA	ARIMA(0,1,1)
January 2020	1092	1068	1080	1015
February 2020	1100	1074	1080	1020
March 2020	1106	1076	1080	1026
April 2020	1108	1078	1080	1031
May 2020	1102	1073	1080	1036
June 2020	1086	1074	1080	1041
July 2020	1099	1074	1080	1047
August 2020	1100	1074	1080	1052
September 2020	1100	1074	1080	1057
October 2020	1099	1074	1080	1062
November 2020	1098	1074	1080	1067
December 2020	1097	1074	1080	1073
January 2021	1099	1074	1080	1078
February 2021	1099	1074	1080	1083
March 2021	1099	1074	1080	1088
April 2021	1099	1074	1080	1094
May 2021	1098	1074	1080	1099
June 2021	1099	1074	1080	1104
July 2021	1099	1074	1080	1109
August 2021	1099	1074	1080	1115
September 2021	1099	1074	1080	1120
October 2021	1099	1074	1080	1125
November 2021	1099	1074	1080	1130
December 2021	1099	1074	1080	1135
% difference from 2019	+8.81%	6.34%	6.93%	+12.38%

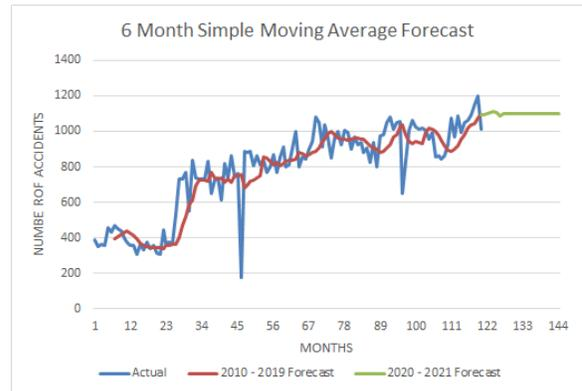

Figure 3.7.1 6-month MA Forecast (Appendix F)

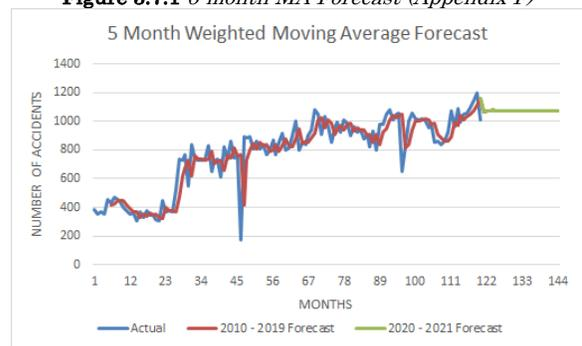

Figure 3.7.2 5-month WMA Forecast (Appendix G)

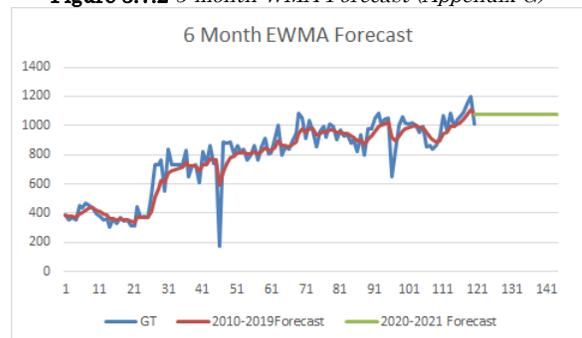

Figure 3.7.3 6-month EWMA Forecast (Appendix H)

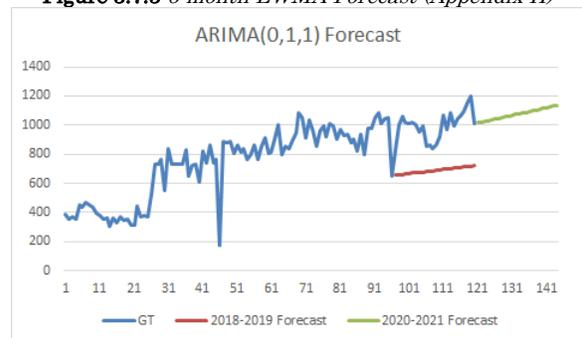

Figure 3.7.4 ARIMA(0,1,1) Forecast (Appendix I)



Perspective on Employment Opportunities of People with Disabilities in San Gabriel, La Union

Chali Grace R. Retuerne, Maven Angela D. Baguistan, Jasmine J. Caliboso, Elisha Joyce N. Libadia, Raven Jay A. Lozano, Ma. Katrine M. Nobleza, Danielle Angeli B. Tomas, and Bon Gregory D. Velasco
Lorma Colleges Senior High School, San Juan, La Union

Abstract: For PWDs, employment is not only a way to gain income; it also gives a chance to showcase untapped skills, provide opportunities and allow social inclusion. However, PWDs still experience common patterns of discrimination and suffer high unemployment rates. In spite of several promotions worldwide, the employment rate is considerably lower for PWDs than for people without disabilities. This study sought to know the status of inclusion of PWDs in employment in San Gabriel, La Union, the opportunities present, and the interventions to address them. The descriptive qualitative design was utilized in this study. A semi-structured interview was conducted with the PWDs. Thematization was used to analyze the responses. Results revealed that the respondents face difficulties in finding a job before the pandemic because of the limited number of jobs available and became even more challenging during the pandemic due to imposed restrictions. Although they find it difficult because of limitations, results showed that they are not discriminated against in the workplace. Moreover, the available employment opportunities for PWDs are classified under blue-collar jobs. Additionally, respondents recommend giving attention to PWDs in order to address the employment opportunities through interventions. The researchers concluded that the status of inclusion of PWDs in employment is considerably low because of the limited jobs available. Similarly, work opportunities are also insufficient. Interventions to address the employment opportunities include facilitating programs and skills training for PWDs and opening simple job positions in the municipality or barangays.

Key Words: PWDs; employment; opportunities; interventions; difficulties

1. INTRODUCTION

1.1. Background of the Study

Just like everyone, PWDs also desire a steady and productive life. Employment not only provides an avenue to be productive and to showcase untapped skills and provides an income that can be used for daily needs, but it will also give opportunities and allow social inclusion, which is significantly important for PWDs. Despite this importance and the right of every person to have access to a job without being discriminated against, people with disabilities experience common patterns of discrimination. They suffer high unemployment rates, are confronted with prejudices regarding their productivity, and are often excluded from the labor market. They also face discrimination at the hiring stage (International Labor Organization, 2021).

The issue of disability and employment has taken center stage in the global arena because it spans several areas of the United Nations Sustainable Development Goals (United Nations Department of

Economic and Social Affairs, 2016). Literature on the employment of PWDs indicates that significant differences exist in the employment experiences between PWDs and persons without disabilities.

Governments worldwide are trying to promote the employment of PWDs by motivating workforce participation and reducing discriminatory tendencies. On the supply side, some governments have started welfare reform programs that encourage PWDs to participate in the workforce. However, in spite of several promotions worldwide, international data from the World Health Organization (WHO, 2020) reveals that the employment rate is considerably lower for women with disability at 20% and men with disability at 53% than that of women without disability at 30% and men without disability at 65%.

Of the 92.1 million households in the Philippines, 1.57% or 1.44 million people had a disability based on the most recent data on people with disabilities found on the 2010 Census of Population and Housing (Philippine Statistics Authority, 2013). Nevertheless, economic



participation is still hard to obtain for most PWDs. According to Schelzig (2005), out of more than 100,000 employable PWDs registered with the Department of Labor and Employment (DOLE), there are only less than 10% of them in wage employment.

A study by Mina (2017) in Cebu, Philippines, on factors that contribute to low employment of persons with disabilities include the lack of employment opportunities within the community of the PWDs. It is stated that the majority of the few formal establishments that hire PWDs are within urban places such as the city and are far from rural areas. In addition, some of the informal enterprises that employ PWDs are carinderias or small eateries that give lower wages and do not include benefits such as bonuses, health care, and leaves.

This study aimed to explore the perspectives on employment opportunities of persons with disabilities in San Gabriel, La Union. This is significant in order to see the point of view of PWDs on employment in their community. This study gives awareness on the current status of inclusion of PWDs in employment and the opportunities that are available for them in the field whether it be sufficient. This study sought to present interventions that could address the present employment opportunities in the said locale.

1.2. Statement of Objectives

This study aimed to investigate the perspective on employment opportunities of people with disabilities in San Gabriel, La Union. Specifically, it seeks to answer the following questions:

1. What is the current status of the inclusion of PWDs in employment in San Gabriel?
2. What opportunities are available for PWDs in San Gabriel, and are they sufficient?
3. What are the interventions to address the employment opportunities in San Gabriel?

2. METHODOLOGY

2.1. Research Design

Give the support for your main claim by This study utilized a descriptive qualitative research design to have an in-depth and comprehensive look at the specific events experienced by individuals or groups of individuals (Lambert & Lambert, 2012). This method underpins how the researchers came up with interventions to address the employment opportunities of PWDs in San Gabriel, La Union.

2.2. Participants and Locale of the Study

The respondents of the study were the PWDs residing at San Gabriel, La Union, who are legally considered adults. A total of 10 respondents were interviewed. The participants include PWDs who are

of the working-age from 18 years old and above who have tried applying for a job, regardless of their employment status at the present time. This also includes retired PWDs. Purposive sampling was used in this study.

2.3 Data Gathering Instrument

A semi-structured interview was conducted to allow the researchers to have a keen understanding of the topic of interest. The researchers utilized a list of paper-based interview guides that contained open-ended questions.

2.4 Data Gathering Procedures and Ethical Considerations

A letter of approval was sent to the principal of LORMA Colleges for the researchers to conduct this study, and a letter of consent was given to the respondents. Because of the current situation caused by the pandemic, social meetings are limited physically. Thus, the researchers conducted the interview with the respondents online.

2.5 Data Management

Thematization was used to analyze the data to be gathered in this study in order for the researchers to effectively organize and cluster specific key subjects from the answers of the respondents that are recurrent.

3. RESULTS AND DISCUSSION

3.1 Current Status of Inclusion

3.1.1 Employment Accessibility

More than half of the respondents admitted that it is difficult for them to find a job in the locale. Participants said that they find it difficult because of their disability and because there are limited jobs available for PWDs in San Gabriel. On the other hand, one respondent, respondent B, said that it is easy to find a job because he became well known for what he does, and other shop owners even offer him a position in their establishments. It can be inferred that for the majority of PWDs in San Gabriel, it is difficult to acquire a job, especially since most of them do not have the privilege of being known, unlike respondent B.

3.1.1.1 Before the Pandemic

The majority of the respondents admitted that they consider finding a job pre-pandemic as challenging and difficult because of the lack of availability of employment in San Gabriel. Conversely, there are two (2) respondents who admitted that it is easy for them to look for jobs despite indifferent circumstances and personally believes that work before the pandemic is favorable.



3.1.1.2 During the Pandemic

All the respondents said that it is even more difficult to find a job during the pandemic. The respondents mentioned that because of the decline of businesses and the present situation, there are only a small number and certain types of job opportunities left for the PWDs in San Gabriel. Moreover, because mobility is restricted, it is more challenging for them to find jobs because they cannot go to other places. Furthermore, the devastating effect of the pandemic on employment is evident around the world, affecting people of different gender, race, ethnicity, education level, age, and occupations (Lee et al., 2021) and thus include PWDs.

3.1.2 Acceptance in the Employment Sector

According to all of the interviewed PWDs, there were no instances wherein they avoided applying to certain establishments because they knew that they would not be accepted because they are considered PWDs. Similarly, there were also no instances wherein they were rejected in an establishment just because they are PWDs. Thus, this implies that PWDs in San Gabriel are not discriminated against and are accepted in the workplace. This then eliminates discrimination as a factor for having difficulty in acquiring jobs. With this, when PWDs are not discriminated against and are accepted in the workplace, they perform better on their jobs, and they feel more supported. (Zhu et al., 2019)

3.2 Availability and Sufficiency of Work Opportunities

3.2.1 Common Work Avenues

The respondents have observed that the common jobs that PWDs have depend on their capability to do work. This is backed by Seva's (2020) study which says that when the right task or job is given to a PWD in consideration of their capabilities, their performance will be positive, thus allowing them to exhibit good work.

3.2.1.1 Cleaning Services and Waste Management

Among the ten (10) respondents interviewed, four (4) answered that one of the most common jobs of PWDs in San Gabriel falls in the cleaning services and waste management industry. This includes janitorial works like road sweeping and garbage collection.

3.2.1.2 Farming/Agriculture

Farming or agricultural work is also common for PWDs as the locale has the highest percentage of agricultural land in the whole province (La Union

Tayo!, 2021). However, the respondents mentioned that farm work is intermittent; thus when farming season ends, work also ends.

3.2.1.3 Beauty and Health

According to the respondents, jobs in the beauty and health industry are also common employment for PWDs in San Gabriel. Specifically, these jobs are hairdressers, hair cutters, barbers, and masseurs.

3.2.1.4 Construction, Repair, and Maintenance

Work as an electronic repairman, maintenance, and carpenter are also common for PWDs in San Gabriel. According to respondent A, although he did not study electronics, he was fond of it, which allowed him to use it for a living by repairing electronics such as electric fans.

3.2.2 Adequateness of Work Opportunities

The majority of the respondents are fully aware of the employment opportunities for them as PWDs in San Gabriel. Nevertheless, results reveal that even though the majority are aware of their employment opportunities, the majority still believes that these are not enough for the PWDs in San Gabriel because they find it significantly difficult to find a stable job in order for them to make a living due to the scanty amount of jobs that they can be hired in. This is backed up by the study of Othman & Jani (2017), which revealed that the employment opportunities of PWDs are limited because of their impairment.

3.3 Interventions to Address the Employment Opportunities

3.3.1 Facilitation of Programs and Training

Among the ten (10) respondents, four (4) of them suggested the conduct of programs and training for PWDs who aspire to learn about different skills that could help them in their livelihood and for them to be employed easier. Specifically, the respondents were pertaining to the free skills training for PWDs by the Technical Education and Skills Development Authority (TESDA) and the National Council on Disability Affairs (NCDA) so that they could receive the National Certificate (NC) which is necessary for job application. The respondents also recommended the provision of basic equipment for their corresponding skill paths, such as screwdrivers and the like, which could be a big help that they could use for daily income. A study by Majid and Razzak (2015) revealed that vocational training and programs are helpful in the rehabilitation of PWDs. This is because vocational training allows PWDs to acquire an



appropriate job that suits them and moreover in congruence to their vocational potential and thus enables them to advance in it and be successful.

3.3.2 Employment Offers for PWDs

Because most of the PWDs settle on jobs that are intermittent, income is also discontinuous. Hence, the respondents recommend opening simple job positions for PWDs such as those whose duties can be considered doable for them, including jobs of the same kind as janitorial positions in the municipality or the barangay in order for them to have a continuous and stable income. A study by Marcella & Nalumen (2020) says that the provision of an adequate standard of living that includes a basic level of security of income helps reduce the levels of vulnerability and poverty of PWDs.

4. CONCLUSIONS

Based on the findings of the study, the following conclusions were derived:

First, the status of inclusion of PWDs in employment in San Gabriel is explained through two (2) themes, namely Employment Accessibility and Acceptance in the Employment Sector. The majority of the respondents face difficulties in accessing employment. It was difficult for PWDs before the pandemic and became even more difficult during the pandemic because of restrictions. On the other hand, PWDs in San Gabriel are accepted in the employment sector as they are not discriminated against when applying for a job. Nevertheless, the current status of inclusion of PWDs in San Gabriel is considerably low, even though they are not discriminated against in the employment sector, given that the majority still faces difficulties in employment accessibility because of the limited jobs available for them.

Second, salient findings of the study revealed that the most common types of jobs of PWDs in San Gabriel are classified under blue collar jobs. Specifically, these include haircutter or barber, hairdresser, masseur, carpenter, agricultural work, janitorial work, and electronics repairman. However, the work opportunities in San Gabriel for PWDs are still not sufficient because of the limited number of jobs that PWDs can get hired for.

Lastly, based on the findings of the study, two interventions were proposed to address the employment opportunities in San Gabriel, La Union. First, programs and training for PWDs should be conducted. Specifically, this pertains to the free skills training for PWDs by TESDA and NCDA. In addition, basic equipment for their corresponding skill paths should also be provided. Secondly, opening simple job positions for PWDs such as janitorial positions in the municipality or the barangay is also proposed in order for them to have a continuous and stable income.

5. ACKNOWLEDGMENTS

The researchers would like to extend their earnest gratitude and appreciation to the following:

To Ms. Antonette Ongngad for her patience, unwavering support, and advice throughout the conduct of the study.

To the respondents from San Gabriel, La Union for their precious time and cooperation in sharing their experiences and perspectives. This study would not have been possible without them.

To Honorable Mayor Herminigildo M. Velasco and Honorable Vice-Mayor Divina D. Velasco of the Municipality of San Gabriel for giving us the permission to interview the PWDs in San Gabriel, along with all the officials who helped and assisted the PWDs in the online interview.

To the researchers' family and friends, for their untiring support, guidance, and encouragement.

Most importantly, we thank God who made everything possible and for giving us the strength, wisdom, and the ability to understand and complete this study.

6. REFERENCES

- International Labour Organization. (2021). Promoting equal opportunities and outcomes in employment for persons with disabilities. Retrieved from ILO Home: http://ilo.org/suva/areas-of-work/WCMS_212132/lang-en/index.htm
- Lambert, V. A., & Lambert, C. E. (2012). Qualitative descriptive research: An acceptable design. *Pacific Rim International Journal of Nursing Research*, 16(4), 255-256.
- Lee, S. Y. T., Park, M., & Shin, Y. (2021). Hit Harder, Recover Slower? Unequal Employment Effects of the Covid-19 Shock (No. w28354). National Bureau of Economic Research.
- La Union Tayo! (2021). Municipality - San Gabriel. Retrieved from La Union Tayo!
- Majid, S., & Razzak, A. (2015). Designing a model of vocational training programs for disables through ODL. *Turkish Online Journal of Distance Education*, 16(1), 212-237.
- Marcella, C. B. R., & Nalumen, M. D. J. (2020). Adequacy of Social Services for Persons with Disability of a Second Class City in Negros Occidental. *Philippine Social Science Journal*, 3(2), 171-172.
- Mina, C. D. (2017). Employment profile of women with disabilities in San Remigio and Mandaue City, Cebu, Philippines (No. 2017-57). PIDS Discussion Paper Series.
- Othman, A., & Jani, R. (2017). Employment Prospect of Persons with Disability: the Myth and Reality. *Philippine Statistics Authority*. (2013, January 10). Persons with Disability in the Philippines



- (Results from the 2010 Census). Population and Housing: <https://psa.gov.ph/content/persons-disability-philippines-results-2010-census>
- Schelzig, K. (2005). Poverty in the Philippines: Income, Assets, and Access. Asian Development Bank.
- Seva, R. R. (2020). A Productivity Assessment of PWD Employees in a Philippine Company. *DLSU Business & Economics Review*, 29(2), 93-103.
- United Nations Department of Economic and Social Affairs. (2016). *Global Sustainable Development Report 2016*. New York, United States.
- World Health Organization. (2020, December 1). 10 Facts on Disability. WHO Newsroom: <https://www.who.int/news-room/facts-in-pictures/detail/disabilities>



Senior High School Students' Political Participation in the Emerging Social Issues

Kenneth B. Ibardezoza, Janna Mae H. Macatangay, Louigie T. Badillo, and Jojiemar M. Obligar
Tanauan City Integrated High School, Tanauan City, Batangas

Abstract: This research examined youth political participation in the emerging social issues in the Philippines. The purpose of this study is to exhibit the vital political participation of senior high school students in the Humanities and Social Sciences (HUMSS) strand of Tanauan City Integrated High School in terms of finding solutions for the various social issues that have been hindering the country from developing. The research question guiding the study is how the youth understand and value interests in social issues in relation to the other forms of political participation. This study employed a qualitative research approach used to analyze data gathered for this study based on 42 respondents. The results indicated that the youth or the present generation has a wide perspective when it comes to political involvement and related concepts. However, the youths expressed that political activities beyond voting facilitate them with opportunities to communicate more specific political messages to politicians multiple times. Voicing out, participating in civic activities, such as rallies and campaigns, and stating and influencing others are some of their ways to engage politically. With some barriers and hindrances young people encountered, they have this eagerness to stand up and enrich their knowledge for the betterment of the country.

Key Words: awareness; political efficacy; political participation; social issues; youth

1. INTRODUCTION

Young people are often excluded or overlooked as political participants regarding diverse issues and problems encountered by a country. The lack of interest in this generation is the result of systematic disregard for government officials because of their young age, limited opportunity, and lack of experience and knowledge in the field of politics. On the other hand, Cabo's (2018) research has proven that the presence of youth in political actions has significant benefits in decision-making and steps in resolving social issues. Freechild (2016) explained that there is a growing interest in youth and politics around the world that made some political groups change their way to respond to the growing number of young people who want to affect the political system. The participation of political youth has benefitted all citizens and the whole society.

The Philippines is generally a third world country and one of the developing countries around the globe. There are many challenges that the country is currently facing to advance and improve its way of living. Social issues such as poverty, anti-terror bill, new normal setup in the platform of education, global pandemic, and climate crisis are some of the biggest problems that need to be addressed. These emerging social issues initiate the start of a bold, attentive, and politically aware generation that stands for

democracy.

Through the years, the Filipino youth has emerged as a powerful force in shaping the nation. The public has witnessed them forward their agenda on various socio-political matters, whether out in the streets or within their circles. Constituting 30% of the Philippine population, the youth's civic participation is fundamental in realizing the values of democracy and good governance (Medina, 2019).

2. METHODOLOGY

This chapter describes the nature of the study in terms of research design, respondents of the study, data gathering instrument, analysis, and interpretation of data.

This study employed a qualitative research approach used to analyze data gathered for this study. Data from these resources was collated and macro-analyzed with a heavy emphasis on the knowledge and participation of Filipinos towards key national issues. This study aims to review the awareness and practices of 42 senior high school students of Tanauan City Integrated High School and come up with data that may be used to see the political awareness and participation of the senior high school students. The study uses the descriptive research design and intends to use a questionnaire to gather the needed data to review the political participation of senior high school



students.

To produce valid and reliable results of this study, the respondents were selected through purposive sampling. This sampling method requires the researchers to have prior knowledge about the purpose of their studies so that they can properly choose and approach eligible participants. The researchers want to access a particular subset of people as all participants of this study are selected because they fit this particular profile.

The respondents of this study are grade 11 and grade 12 students under the Humanities and Social Sciences (HUMSS) strand of Tanauan City Integrated High School. They were chosen to be the respondents of this study since they have an overview and knowledge about Philippine Politics and Governance under the K to 12 Basic Education Curriculum for senior high school.

In order to elicit the information needed in this study, the researchers decided to use a self-constructed validated questionnaire. This was done after intensive research from various sources and with close coordination and consultation with the research adviser. Moreover, the questionnaire underwent content validation.

The questionnaire was submitted to the research adviser for checking for possible corrections. Afterward, it was examined by the researchers' internal and external validators for the grammatical and structural construction correction. The researchers modified the questions so that they could apply them accordingly to the purpose of this study.

A three-section survey questionnaire was used in this study. A questionnaire is used when factual information is desired. This gives opportunity for the person administering the instrument to properly explain the purpose of the study and its terms and to accurately acquire and assess information. Section (1) draws information about the socio-demographic profile of the respondents, which includes name, gender, and level of education, but it is optional. Section (2) of the questionnaire evaluates the awareness of the respondents about politics and any related topics. The questions were designed to assess the awareness of the respondents in social issues and are based on contemporary political and current issues in the country. Section (3) determines the stage of practice of the respondents in acquiring information about politics and the involvement of the respondents in politics appropriate for their age and level of education. The questions regarding the practice and the involvement of the respondents are about the efforts of the respondents in understanding politics and in reacting to political issues.

The researchers sought permission from the school head of the Tanauan City Integrated High School to administer the questionnaires through a

request letter that was sent online. The questionnaires were distributed via Google form, text messages, and private message in Messenger. At the start of distributing questionnaires to the persons of interest, pertinent ethical considerations were observed. Specifically, permission was sought from the respondents regarding the use of their information, and answers are still bound to follow the Data Privacy Act and related issuances about the processing of personal data, upholding the rights of their data subjects and maintaining compliance with other provisions that are not incompatible with the protection provided by the implementing rules and regulations of Data Privacy Act of 2012. Respondents were also given an opportunity to ask questions about the research.

Recording and organizing of written responses were used to determine the awareness of senior high school students and their own political participation in the present times. The researchers analyzed all the answered questionnaires for analysis and interpretation of the data. The researcher evaluated the result carefully. Analysis and interpretation of every item in the questionnaire was done by the researcher in order to come up with meaningful findings and conclusions and draw some contributing recommendations.

3. RESULTS AND DISCUSSION

The findings showed the visible political participation of senior high school students in the present times. This general presentation preceded the identification of the level and application of selected students when it comes to their political perspective in the Philippines.

3.1 Forms of Political Participation

To bring about the needed changes in society, some participants stated that they should engage in prosocial acts. Voicing out, participating in civic activities such as rallies and campaigns, and stating and influencing others are some ways to engage politically. Another way of participating politically is to avoid criminal activities, avoid deviant peer groups, be good citizens who follow laws, or choose to act in morally devoted ways. Youth political participation can thus take many forms ranging from traditional democratic politics to more creative, novel, and remarkably distinctly contemporary forms, shaped and inspired by their particular socio-political backgrounds and global social movements (Cabo, 2018). Additionally, young people focus more on online political participation in the sense that it is more convenient and can be accessed with ease. As Batool et al. (2020) suggest, social media has a crucial role in constructing political efficacy and political



participation working under Uses and Gratification, Media Richness, and Social Engagement theories. This shows that there is a great effect that social media offers on accessing information and participating politically. It proves that the youth has contributed to changing the mode of protest from streets to cyberspace (Lim, 2009).

3.2 Awareness of Social Issues

Diverse answers were recorded when it was asked what their top five social issues in the Philippines are. Generally, seven concepts were tabulated from their responses. These are societal problems, the pandemic, poor governance, pollution, economy, and education. The majority of the respondents showed interest in participating in solving social issues. In addition, most of the respondents have linked being aware of the emerging social issues and their political participation. The respondents emphasized that if a person deeply understands the emerging social issues, it will enable them to pave the way for change and improvement. They are willing to take small actions to make big changes even though they're only students. The response of one participant explains this: "Even though I am not legally credible to make change for the welfare of this country, awareness as a student is enough as of the moment which I can apply in the future."

This supports the analysis of Cabo (2018) that each generation developed its own variety of behaviors and viewpoints, including awareness of social issues and politics, shaped and influenced by major historical and social changes that happened during their formative years.

3.3 Youth Perspective on Performing Political Participation

There are functions and purposes of political participation that arise in the survey. The respondents see political participation as part of self-development and an eye-opener. Also, it arises that political participation is a beneficial tool for youth because once we are aware of which leads to our capability to do something, we can make a change. As Checkoway (2011) suggests, youth participation strengthens personal and social development, provides expertise for children and youth programs and services, and promotes a more democratic society. This is shown on their responses on having the eagerness to bring a clean and equal government for all. However, some of the respondents expressed their opinion that political participation is not beneficial for them because they are not totally interested in this kind of matter. The respondents stated that they are not taking it seriously and not letting these issues

fully overcome by anything that has an involvement with politics. These findings were associated with Grasso's (2014) analyses that today's youth is the least politically engaged generation when it comes to formal and informal political participation. In addition, 'Millennials' seem to be a 'unique' generation, disengaged from any form of political participation (Fox, 2015).

Overall, the youth have different perspectives on this kind of motive. The majority of the respondents illuminate the purpose of the application of involvement in political participation, but some of them have not yet ignited the match and the light of political participation in their lives, so they stated that it is not profitable for them.

3.4 Promoters of Political Participation

There were important themes that emerged from the participants' responses on what can facilitate and strengthen their application of political participation. The first theme had to do with trust in oneself. A second theme had to do with the possession of knowledge. The third theme was concerned with the sense of commitment one has in performing one's duties in society. The inner courage, a sense of determination, a resolve to increase one's knowledge, and an emphasis on the obligation to the performance of one's duties were indicative of the youth awareness that political action springs from within and not from the persuasion of others (Cabo, 2018). Moreover, the respondents also highlighted that political efficacy is very influential when it comes to dealing with political stances, as the confidence that an individual plays a major role in promoting change for the sake of the country. Furthermore, there are important roles education carries to build youth with critical minds on solving country's problems. There are four reasons why education affects the political participation of the students. First, it gives awareness to every learner. Second, education is the strongest foundation of knowledge. Third, education nurture our decision-making skills. Lastly, education gives enlightenment. These themes and factors promote and toughen political participation among youth.

3.5 Barriers to Political Participation

There were general barriers that emerged from the participants' responses. As Farthing et al. (2010) indicated on their research, participation in political activities is in crisis, especially when it comes to young people, and this is a major issue facing contemporary democracies. These blocks include differences in age, fear of the possible consequences of partaking, and the lack of time and knowledge on social issues. This is related to the analysis of Bunquin (2020) that the youth do not engage in conversations



related to political issues because they are prone to inequality. Also, they are afraid of the possible consequences of their involvement that can put their lives at risk. Youth are degraded because of their young age and not having adequate time on accumulating knowledge that excluded them to participate politically.

4. CONCLUSIONS

Based on the findings of the study, the following conclusions were made:

Different themes on the forms of political participation, and barriers and promoters of engagement highlighted the importance given by the youth to the interactions with others and the influence of new technology in the conduct of political activities. The emphasis on prosocial behaviors as forms of political action and having enough knowledge about social issues as an important support for the maintenance of political action was remarkable. Most of the responses indicated that being socially aware will light up the fire in our hearts to contribute in the political process or participation in the country.

Young people focus more on online political participation in the sense that it is more convenient and can be accessed with ease. Moreover, online channels are frequently used mostly for searching political information, reading articles and news, among others.

Most of the respondents stated that in having themselves involved in political affairs, there are other variables that they have to consider, like having trust in themselves to make a stand together with the possession of knowledge, which is essential for them to justify their point and opinions, and sense of commitment in doing so as it will be the holding point for them to continuously move forward with their agenda.

The barriers being accumulated were in terms of age, danger, and insufficient knowledge and time allotted for this matter. It is evident that youth were afraid of the risk when they speak up.

5. ACKNOWLEDGMENTS

First and foremost, praises and thanks to God, the Almighty, for His showers of blessing throughout our research work to complete the study successfully.

The researchers would like to express their deep and sincere gratitude to their research teacher, Mr. Jojiemar M. Obligar, for giving them the opportunity to do research and for providing inestimable guidance throughout this research. His sincerity and motivation have deeply inspired them to complete this study. He has taught the researchers methodology to carry out the research and present the

study as clearly as possible. It was a great privilege to do research under his guidance.

The researchers are also extremely grateful to their family for giving them full support, either it's moral or financial support, to their friends who motivate them, and to the researchers' adviser, Mrs. Irene-Belen Bron, for being there until the end;

To Mrs. Lilibeth L. Cabrera for allowing the researchers to conduct this study inside Tanauan City Integrated High School;

To the respondents who cooperated in this study by answering the research questionnaires; their cooperation was incomparable through the research project.

6. REFERENCES

- Batool, S., Yasin, Z, Batool, A. (2020). Role of social media in democratization in Pakistan: An analysis of political awareness, efficacy and participation in youth. *International Review of Social Sciences*, 8(9).
https://www.researchgate.net/profile/Aaima_Batool/publication/346425595_Yasin_Batool_2020_144_I_wwwirssacademyirmbr/links/5fc1126a92851c933f67163d/Yasin-Batool-2020-144-I-wwwirssacademyirmbr.pdf
- Bunquin, J. B. (2020). The effects of social media use and political communication networks on the Filipino youth's political. *Researchgate.net*.
https://www.researchgate.net/publication/343837980_The_effects_of_social_media_use_and_political_communication_networks_on_the_Filipino_youth's_political_participation
- Cabo, W. L. (2018). Youth and political participation in the Philippines: Voices and themes from a democracy project. *Journal of Politics and Governance*, 8(1), 259–271. <https://so03.tcithaijo.org/index.php/jopag/article/view/123298>
- Checkoway, B. (2011). What is youth participation? *Children and Youth Services Review*, 33(2), 340–345.
www.sciencedirect.com/science/article/abs/pii/S0190740910003270, 1
0.1016/j.childyouth.2010.09.017.
- Farthing, R. (2010). The politics of youthful antipolitics: Representing the 'issue' of youth participation in politics. *Journal of Youth Studies* 13(2), 181–195. Taylor & Francis Online.
<https://www.tandfonline.com/doi/abs/10.1080/13676260903233696>
- Fox, S. (2015). Apathy, alienation and young people: the political engagement of British millennials.



Nottingham ePrints. Nottingham.ac.uk.
<https://doi.org/http://eprints.nottingham.ac.uk/30532/1/Final%20Corrected%20Version%20-%20Apathy%2C%20Alienation%20and%20Young%20People%20The%20Political%20Engagement%20of%20British%20Millennials.pdf>

Freechild, A. (2016). Youth and politics. Freechild Institute. <https://freechild.org/2016/01/20/youth-and-politics/>

Grasso, M. (2014). Age, period and cohort analysis in a comparative context: Political generations and political participation repertoires in Western Europe. *Electoral Studies*, 33, 63–76.
<https://www.sciencedirect.com/science/article/abs/pii/S0261379413000838>

Lim, N. (2009). Novel or novice: Exploring the contextual realities of youth political participation in the age of social media. *Philippine Sociological Review*, 57, 61–78.
<https://www.jstor.org/stable/23898344?seq=1>

Medina, C. (2019). The government we want: The youth agenda for. *Ilead.ph*.
<http://ilead.ph/2019/01/01/the-government-we-want-the-youth-agenda-for-governance/>

Ramos, P. G. (2019). The voice of the Filipino youth: Silver linings in the 2019 midterm elections. *Eia*.
<https://www.eias.org/news/the-voice-of-the-filipino-youth-silver-linings-in-the-2019-midterm-elections/>

Duenwald, M. (2004, January 6). Slim pickingsL Looking beyond ephedra. *The New York Times*, p. F1. Retrieved October 12, 2004, from LexisNexis.



Modernized Tradition: Transformation of Public Transport

Marco Sebastian Q. Atos, King Henry B. Cabe, Chrislagne Jasmine E. Gomez, Kyla Dee D. Manantan and Chelsea Lean O. Padupad
Berkeley School, Baguio City

Abstract: Due to incrementing environmental issues, the Philippine government has aimed solutions for sustainable development by pursuing the Public Utility Vehicle Modernization Program (PUVMP), which was launched in 2017 and took effect in 2020. The program included the modernization of jeepneys, which is a historical icon in the country. The modernization of jeepneys affected jeepney drivers, operators, and commuters alike; thus it is crucial to take their opinions into consideration. In this study, the researchers ought to know the thoughts and opinions of jeepney drivers and commuters concerning the PUVMP in Baguio City. The study that was executed embraced a phenomenological approach. Due to the pandemic the world is facing at present, the responses were gathered using an online survey as it was seen to be fit for the current situation. The results exhibited divided opinions towards the program as drivers and operators were against it, while commuters supported the program. The jeepney drivers and operators used their financial status as a basis for their opinion, while commuters prioritized their safety and comfort. When asked how will they cope with the PUVMP, jeepney drivers showcased a negative array of choices. Their answers varied from complying just because it is what the government wants, opting for illegal schemes to earn money, to losing their jobs completely. The results acquired can be used as a basis for adjustments and changes to produce an ameliorated program which satisfies the needs and wants of the affected groups.

Key Words: Modernization; Jeepney; Drivers and Operators; Commuters; PUVMP

1. INTRODUCTION

1.1. Background of the Study

Since the 1940s, jeepneys have been a huge part of the daily life of Filipinos, transporting local and non-local commuters to certain locations. It's not a stretch to say that their daily routines depend largely on public transportation. Not only are jeepneys a mode of transportation, it has become a historical symbol and is also one of the famous public transport here in the Philippines aside from tricycles and kalesa which are only in certain places. Jeepneys aren't usually seen anywhere else; that is why it strikes amusement and serves as an experience for first-timers. It also serves as a canvas showcasing arts because of the unique and delightful designs each jeep has. Jeepneys were made available to the Filipinos by the end of World War II. Nonetheless, the jeepneys back then didn't look exactly like the jeepneys we see today. The traditional jeepney was recycled from galvanized or stainless steel. They had fabric covers instead of side windows and longitudinally mounted benches with room for 20 or more (Meiners, 2016). The Filipinos then modified the jeep's appearance and size to accommodate more passengers. Adornations such as the signboard, the route, and colorful strips of plastic attached to the front sides of the jeep make it more

vibrant and known in the streets. In addition, jeepneys are the most affordable and budget-friendly kind of transportation, with fares starting at 7 to 8 pesos.

Although jeepneys are a major part of Philippine history, due to concerns regarding their contribution to the pollution in the environment, harsh restrictions and regulations are being implemented. Traditional models of jeepneys have violated multiple rules, which include overloading and pollution. These violations prove to be risky as these have contributed to health hazards, and by phasing out the traditional jeepneys, violations such as the ones aforementioned could be greatly reduced (Cudis, 2019). With the trial runs done by the government, the general public is ready to accept the revamped jeepneys as they agree that it'll be better for the people and the environment in the long run (Cudis, 2019).

As the Philippine government is aiming for more sustainable development to counter the environmental issues caused by vehicles, the Philippine government and DOTr issued Department Order No. 2017-011 (Re: Omnibus Guidelines on the Planning and Identification of Public Transportation Services and Franchise Issuance) or the Public Utility Vehicle Modernization Program (PUVMP), which was launched back in 2017 (LTFRB, 2017). Popioco and Morales (2017) further explain that the program



aimed to alter the country's public transportation systems to become more efficient and environmentally friendly by replacing old jeepneys with jeepneys that have a Euro-4 compliant engine or an electric engine that lessens the contribution of the said vehicle to the pollution present in the environment. As of May 2020, the LTFRB and DTI have presented 16 prototype jeepneys that were locally manufactured based on the guidelines set by the DOTr. These replacement jeepneys were set to substitute jeepneys that were 15 years or older, hence affecting drivers and operators who have been serving the industry for the longest time (Nano, 2017).

Alongside the PUVMP's budget of ₱2.2 billion (Cabuenas, 2017), The Land Bank of the Philippines estimated that each replacement jeepney will cost around ₱1.2 to ₱1.8 million (Popioco & Morales, 2017); thus, the PUVMP has been criticized as "anti-poor" (Philstar, 2017). Despite the criticism towards the program, multiple government agencies, transport groups (DOTr, 2017), and international partners (Abadilla, 2017) have expressed their support towards the program.

As estimated by Westerman (2018), the number of jeepneys in the country is around 180,000-270,000. With how commuters depend on these public transportations, drivers largely depend on their vehicles as well. Though commuters have a great deal regarding the fare they pay, Westerman (2018) states that jeepney drivers usually earn an average of 700 pesos every two days, but that amount is uncertain as jeepney drivers face certain setbacks that lessen the amount they make. Guss and Tuason (2012) add that certain setbacks include work-related problems that hinder the ability and time to transport passengers, which, in result, lessens the amount these road masters make. Furthermore, the money they spend on maintenance and gas is dependent on their income. As explained by Manuel (2019), the amount jeepney drivers gain in their livelihood is sometimes not even enough to provide for their families; thus, if the PUVMP is fully implemented and the jeepney drivers take out loans to pay for the replacement jeepneys, the additional debt will deprive them of their basic necessities. Manuel (2019) adds, with the number of jeepneys in the country and the hefty price operators and drivers will be paying for the replacement jeepneys, the greatest concern these road masters have is their livelihood as they are afraid that the hefty cost of the replacement jeepneys will leave them with nothing but debt and loss of their livelihood, making their already difficult lives even more difficult.

Due to the hefty estimated price of each replacement jeepney, the Development Bank of the Philippines (DBP) signed a Memorandum of Understanding (MOU) with DOTr to provide aid

through the DBP PASADA Financing Program, which will help cooperatives financially under terms, conditions, and requirements that the operators should comply to. In addition, DOTr also signed an MOU with the Land Bank of the Philippines for ₱1 billion under the Special Environment-Friendly and Efficient Driven (SPEED) Jeepney Program for the financial assistance of individual drivers (Newman, 2017). To further ease the financial concerns of operators and drivers, DOTr and LTFRB will be providing financing schemes, which include an easy downpayment, very low interest rates, payability in seven years, and an ₱80,000 government subsidy, to be able to pay for a replacement jeepney (Mercurio, 2019).

However, no matter how ready the affected communities already are, it is prime to note that the PUVMP will bring about a drastic change; thus the phase-out shouldn't be immediate as the general public, jeepney drivers, and operators need time to get used to the new and modernized jeepneys. As the government failed to phase out traditional jeepneys by June 2020, as of March 2021, the program has been constantly improved to conform to the needs of the affected communities by including more benefits, which include monthly salaries, SSS, PhilHealth, and a separate profit from the cooperative (Mercurio, 2020).

1.2. Problems of the Study

As stated, commuters have a positive perception towards the modernization plan and jeepney drivers are against it due to the hefty price they will be paying. In this paper, the researchers aim to see if the positive perception of the commuters is indeed true, and on the other end, the researchers aim to gather responses from jeepney drivers to see if they have already thought of coping mechanisms once the program is fully implemented.

To be able to gather the data required, the researchers have generated two questions, one for commuters and one for jeepney drivers.

How do local commuters in the City of Baguio perceive the government's jeepney modernization plan?

How do the local drivers plan to cope with this jeepney modernization program?

Depending on the answers given by the respondents, the researchers were able to identify specific problems the program generated and ways such could still be developed and enhanced.

2. METHODOLOGY

2.1. Research Design



The researchers embossed a phenomenological approach in this study. As stated by Creswell (2013), phenomenology is an approach to qualitative research that focuses on the commonality of a lived experience within a particular group. The fundamental goal of the approach is to arrive at a description of the nature of the particular phenomenon. The researchers' strategy was based on either their own or individual experiences and sensory perceptions. Utilizing qualitative conception, the researchers were able to frame the driver's and commuter's thoughts on the jeepney modernization plan.

2.2. Sampling Method

In this study, the researchers concluded that these two sampling methods were suitable for gathering respondents: simple random sampling and snowball sampling. Simple random sampling was used to find and collect data from commuters in Baguio City to get equal and unbiased responses as it was easy to find respondents willing to participate in the study. Simple random sampling is a method wherein the respondents are purely chosen by chance (Shantikumar, 2018).

The sampling method used to get data from jeepney drivers in Baguio City was the snowball sampling method. The researchers discussed the difficulty of collecting responses from the jeepney drivers in Baguio City due to the COVID-19 pandemic hindering access to jeepney associations and cooperatives; therefore, this non-random sampling method was used to help encourage other participants to take part in the study. As stated by Breweton and Millward (2001), snowball sampling is a sampling method wherein respondents encourage other possible respondents to participate in the study.

2.3. Population and Locale of the Study

The study respondents were nine jeepney drivers and nine commuters from Baguio City with social media accounts. The researchers chose commuter respondents from different fields and had different experiences with the traditional jeepneys. The nine jeepney drivers were drivers who traveled the Baguio Plaza - Holy Ghost route.

2.4. Data Gathering Instruments

Due to the COVID-19 pandemic, an online survey became the most practical data collection tool, where a set of questions were sent out to a target sample to respond to the questions (Bhat, ND).

2.5. Data Analysis

For the data analysis, the researchers used thematic analysis as their method of analyzing the

data. The answers given by respondents were categorized into codes that corresponded to master themes. Thematic analysis, as defined by The University of Auckland (nd), is an analysis method that focuses on identifying patterns in the answers of the respondents.

3. RESULTS AND DISCUSSION

Table 1. Master Themes from Commuter Respondents Regarding Perception on the Government's Jeepney Modernization Plan

Master Themes	Corresponding Codes	Exemplar Quotes
Positive Perception	Modern Jeepneys	"To upgrade the old jeepneys into much safer and more environment-friendly ones."
	Safe	" <i>Maganda ito para sa mga commuters at sa mga driver dahil para din ito sa safety ng lahat.</i> "
	Brilliant	"My thoughts on the jeepney modernization plan is a good plan."
	Spacious	"While it's great that our jeepneys would become eco-friendly and spacious in the future"
Negative Perception	Culture Loss	"Sadly, the touch of our culture would be lost, and I think that would be a shame to the future generation."

As established in Table 1, the key commuter informants positively favor the government's jeepney modernization plan. As quoted by some of the respondents, "My thoughts on the jeepney modernization plan is a good plan," and "While it's great that our jeepneys would become eco friendly and spacious in the future." Based on the test run of modern jeepneys conducted by Hino, the public seemed to favor the government's PUVMP as it proved to be much safer and comfortable compared to traditional jeepneys.

Table 2. Master Themes from Commuter Respondents Regarding the Benefits of the Government's Jeepney Modernization Plan

Master Themes	Corresponding Codes	Exemplar Quotes
Positive Expectations	Safe	"As a commuter, I will feel safer knowing that the drivers will be using new jeeps instead of the old ones."
	Comfortable	"It will also be convenient and comfortable for me since it will be more advanced."
	Convenient	"Can lead me faster to my destination"
	Cheaper Fees	"Lesser commuter fee"
	Less Pollution	"Less polluted environment caused by the old jeepneys"

As shown in Table 2, the key commuter informants expect benefits from the government's PUVMP as they look forward to the comfort and safety the modernized PUJs will bring. As quoted by one respondent, "As a commuter, I will feel safer knowing that the drivers will be using new jeeps instead of the old ones. It will also be convenient and comfortable for me since it will be more advanced." Cudis (2019) claims that by phasing out the traditional jeepneys, violations such as health hazards could be reduced as



the PUVMP's purpose is to replace old jeepneys with much safer, eco-friendly, and comfortable units.

Table 3. Master Themes from Driver Respondents Regarding Perception on the Government's Jeepney Modernization Plan

Master Themes	Corresponding Codes	Exemplar Quotes
Negative Perception	Change	" <i>Papalitan ng bago modelo ang mga jeepney.</i> "

	More Research	"To do more research about it"
	Expensive	" <i>Papalitan ng napakamahal na jeep</i> "
	Not Needed	" <i>Para sa akin ndi na kailangan ito</i> "

Unlike the positive perception from commuters, the key jeepney driver informants showcased negative perception towards the PUVMP. Table 3 showcases the jeepney drivers complaining mainly about the change of jeepneys and the cost they have to pay. Drivers also stated that the PUVMP is not needed.

Table 4. Master Themes from Driver Respondents Regarding Experiences Related to the Government's Jeepney Modernization Plan

Master Themes	Corresponding Codes	Exemplar Quotes
Negative Experiences	Burden	" <i>Maraming driver ang mawawalan ng trabaho pag dating ng jeepney modernization. Dahil hindi kayang bumili ng mga operator ang binebenta ng mga gobyerno na worth 2.4 million payable in 7 years.</i> "
	Pollutant	" <i>mansok na sasakyan</i> "
No Experiences	No experience	"None" " <i>Wala pa</i> "
	Needs further understanding	"Need to understand more."

Table 4 exhibits that key jeepney driver informants have negative experiences with the PUVMP. As quoted by one respondent, "*Maraming driver ang mawawalan ng trabaho pag dating ng jeepney modernization dahil hindi kayang bumili ng mga operator ang binebenta ng mga gobyerno na worth 2.4 million payable in 7 years. (Lots of drivers will lose their jobs because they are unable to pay the cost of the replacement.)*" As said by Manuel (2019), operators and drivers are afraid they won't have enough financial support to afford a replacement unit.

Table 5. Master Themes from Driver Respondents Regarding their Coping Ways if the Jeepney Modernization Plan will be Implemented

Master Themes	Corresponding Codes	Exemplar Quotes
Resignation	Cooperation	" <i>Walang magagawa kung ipapatupad ang modernisasyon dahil gobyerno mismo ang may gusto.</i> " " <i>I will cooperate as long as the modernization process is good.</i> "

	Colorum scheme	"I'll go with colorum scheme as I cannot allow to put on hold my own franchise."
Denial	Hard time	" <i>Mahihirapan.</i> "
	Cannot cope	" <i>Hindi kakayanin yan ng ordinaryong operator. Kasi ang boundary ng jeep hindi akma sa buwanang hulog ng sasakyan.</i> "
	Expensive	"I cannot pay the cost of modern jeepneys."
	No Jobs	" <i>Wala na pong trabaho.</i> "

As showcased in Table 5, the key jeepney driver informants are clearly torn between coping and not coping. As noted by 1 respondent, some jeepney drivers including himself will be going with the colorum scheme, which is an illegal public transport scheme, as they cannot afford the replacement units and putting their franchise on hold. Although, another jeepney driver stated, "*Walang magagawa kung ipapatupad ang modernisasyon dahil gobyerno mismo ang may gusto. (We can't do anything else as it is what the government wants.)*" This shows the lack of choices drivers have. If they won't comply, they will not be able to earn a living. Another respondent expressed concern about the financial crisis operators could be facing because of the implementation. He noted, "*Hindi kakayanin yan ng ordinaryong operator kasi ang boundary ng jeep hindi akma sa buwanang hulog ng sasakyan. (Ordinary operators can't afford it as the monthly income they get isn't enough.)*" According to Manuel (2019), the income of drivers and operators will not be enough to pay for the price of a new unit. Furthermore, if drivers and operators do afford a unit by taking out loans, they would be spending all their income to pay off their debts.

Table 6. Master Themes from Driver Respondents Regarding Suggestions to make the Government's Jeepney Modernization Plan Better

Master Themes	Corresponding Codes	Exemplar Quotes
Modern Upgrade	Recondition	" <i>Makakabuti sa lahat kung upgrading sana sa mga jeepney, papagandahin at aausin nalang sana at palitan nalang ng bagong makina keysa bibili pa ng napakamahal nilang inaalok na modernized jeepney.</i> " " <i>Strict implementation of motor vehicle inspection especially smoke emission as not all old jeepneys with euro2 engines are bad smokers. Mine as I always maintain my jeep can have a smoke emission lower than modern cars.</i> "
Status quo	Discontinue	"No to modernization."

Table 6 exhibits the suggestions drivers have that can be used to improve the current bill. One respondent stated, "*Makakabuti sa lahat kung upgrading sana sa mga jeepney, papagandahin at aausin nalang sana at palitan nalang ng bagong makina keysa bibili pa ng napakamahal nilang inaalok na modernized jeepney. (It will be better if the jeepneys will only be upgraded and fixed instead of buying the expensive modernized jeepneys.)*" Another



respondent also expressed that “Strict implementation of motor vehicle inspection especially smoke emission as not all old jeepneys with euro2 engines are bad smokers. Mine as I always maintain my jeep can have a smoke emission lower than modern cars.” In summary, drivers suggested the discontinuation of the PUVMP, and a simple upgrading and regular inspection of old units can do the work.

4. CONCLUSIONS

After conducting surveys on both commuters and jeepney drivers, the respondents have provided their insights on the problems aforementioned.

The viewpoints from each group of respondents opposed each other as most of the commuters responded positively towards the jeepney modernization program, unlike the jeepney drivers, due to the fact that it is more environmentally friendly and would reduce accidents due to the mechanical failure of old jeepneys.

Jeepney drivers showcased varied answers when asked for their coping mechanisms once the PUVMP is fully implemented. Some drivers decided to just cooperate as it is what the government wants, while others would just opt for illegal methods like the colorum scheme. While some of the drivers came up with coping mechanisms, the other half of the respondents stated that they would not be able to cope, thus losing their jobs as jeepney drivers.

5. ACKNOWLEDGMENTS

First and foremost, we would like to thank God for giving us the strength, wisdom, patience, and perseverance needed to complete this research paper. Secondly, our family, for providing us with all the support that we need not only during the entire period spent on this research paper, but also the help and support they give every single day. We would also like to extend our gratitude to each jeepney driver and commuters who took time out of their schedules just to take part in this research. Lastly, our deepest gratitude goes to our research instructor, Sir Alfonso B. Astudillo III, for guiding us and teaching us throughout the development of this research paper, as well as giving us the opportunity to share our research paper with respected researchers. Without his wisdom, knowledge, and lessons, this research would have never been finished.

6. REFERENCES

Abadilla, E. (2017). Public and private sectors push for PUV modernization. Retrieved from <https://business.mb.com.ph/2017/06/21/public-and-private-sectors-push-for-puv-modernization/?fbclid=IwAR2JD1dVMucOqsyLF1dP5tzsmgLC065saTuMzoWoOoWD8P1bNRFRCec4a8E>

Bhat, A. (n.d). Online Surveys: Definition, Characteristics, Examples, Advantages and Disadvantages. Retrieved from <https://www.questionpro.com/blog/what-are-online-surveys/>

Breweton, P. & Millward, L. (2001). Organizational Research Methods. Retrieved from <https://www.semanticscholar.org/paper/Organizational-Research-Methods%3A-A-Guide-for-and-Brewerton-Millward/f5844354b334d745539ac4917386bbd1ff52badb>

Cabuenas, J. (2017). Gov’t allots P2.2 billion to subsidize PUV modernization –LTFRB. Retrieved from <https://www.gmanetwork.com/news/money/motoring/616634/gov-t-allots-p2-2-billion-to-subsidize-puv-modernization-ltfrb/story/>

Cudis, C. (2019). Commuters await PUV modernization. Retrieved from <https://www.pna.gov.ph/articles/1081862>

Creswell, J.W. (2013). Qualitative Inquiry & Research Design: Choosing Among the Five Approaches. Thousand Oaks, CA: SAGE Publications, Inc. (pp. 77-83)
Department of Transportation. (2017). 24 agencies, 20 transport groups and cooperatives push for PUV modernization. Retrieved from http://dotr.gov.ph/latest-news/255-24-agencies-20-transport-groups-and-cooperatives-push-for-puv-modernization.html?fbclid=IwAR2pc5-S7bLJgkJtsgktrKo5FPnkA9KIXl3TQWM_0rE4S6D5RiIgkqp21Ps

Department of Transportation. (n.d). DBP to provide PHP1.5- finance facility for DOTR’s PUV modernization program. Retrieved from http://dotr.gov.ph/2014-09-02-05-01-41/latest-news/297-dbp-to-provide-php1-5-b-finance-facility-for-dotr-s-puv-modernization-program.html?fbclid=IwAR1jaaQC7_b9jvocoMWJQUVPfvkvrpEvl6PmnTq2JQ9xl9WQ9_tiwWBU



- Güss, C. & Tuason, Ma. (2008). Jeepneys: Values in the Streets. *Culture & Psychology*. 14. 211-236. 10.1177/1354067X08088559. Retrieved from https://www.researchgate.net/publication/277455109_Jeepneys_Values_in_the_Streets?fbclid=IwAR36Ztr61QjonGpUD9p9U9uto3_bLUP_f5FQWd0jJdMIWJUBpoAt2J7tZk0
- LTFRB (2017). PUV modernization. Retrieved from <https://ltfrb.gov.ph/puv-modernization-2/>
- Manuel, R. (2019). I'm a jeepney driver in the Philippines. Here's what I'm afraid of. Retrieved from <https://www.vice.com/en/article/a353a5/jeepney-driver-philippines-against-phase-out-modernisation>
- Meiners, J. (2016). The History of the Jeepney, the Philippines' Mass-Transit Solution. Retrieved from https://www.caranddriver.com/news/a15344340/the-history-of-the-jeepney-the-philippines-mass-transit-solution/?fbclid=IwAR10fM6Ax2n_0AI1yn2kGDb_mXs-e33KqUfVK4s6EMo24ii9JafP928-0zw
- Mercurio, R. (2019). Banks ready to extend financing for PUV modernization program. Retrieved from https://www.philstar.com/business/2019/01/16/1885365/banks-ready-extend-financing-puv-modernization-program?fbclid=IwAR0T1pdihMaiDbr_7dS5b1ow7K-PRumTH32krKHptObPAV0GnMV3rNEBg8
- Mercurio, R. (2017). Why some transport groups oppose PUV modernization. Retrieved from <https://www.philstar.com/headlines/2017/09/26/1742854/why-some-transport-groups-oppose-puv-modernization>
- Mercurio, R. (2020). PUV modernization gets boost. Retrieved from <https://www.philstar.com/business/2020/02/24/1995477/puv-modernization-gets-boost>
- Nano, J. (2017). Proposed designs of modernized jeepney models, unveiled to the public. Retrieved from <https://www.untvweb.com/news/proposed-designs-modernized-jeepney-models-unveiled-public/>
- Newman, M. (2017). Orbos pushes PUV modernization. Retrieved from <https://news.mb.com.ph/2017/10/27/orbos-pushes-puv-modernization/?fbclid=IwAR32WafhVHw7RIKdX-cT68NVeyl-lan1hzNi3yJYFzt2HffYZ2DgSv5qsSM>
- Popioco, M. & Morales, Y. (2017). Jeepney modernization program kicks off next month. Retrieved from <https://cnnphilippines.com/transportation/2017/06/20/Jeepney-modernization-program-kicks-off-next-month.html?fbclid=IwAR1pfCtYLDc1YhWOyuGAXu6Rz-qPIKt4zpcx8RCc0VTyoXEAsKSPtUTIAQM>
- The Philippine Star. (2017). Why some transport groups oppose PUV modernization. Retrieved from <https://www.philstar.com/headlines/2017/09/26/1742854/why-some-transport-groups-oppose-puv-modernization>
- Westerman, A. (2018). A push to modernize Philippine transport threatens the beloved jeepney. Retrieved from <https://www.npr.org/sections/parallels/2018/03/07/591140541/a-push-to-modernize-philippine-transport-threatens-the-beloved-jeepney>

Ur Next GF: Urine as Next Generation Fertilizer with Meat and Bone Meal Applied on *Vigna radiata* (Monggo plant)

Sachie Daniela G. Cheung, Azelea M. Dionisio, Sarah Michaella I. Madayag,
 and Anna Sophia L. Sampang
 Engr. Ithan Jessemar Dollente and Dr. Michael Angelo Promentilla
De La Salle University Integrated School, Manila

Abstract: Fertilizers play an important role in providing crops with essential nutrients such as nitrogen (N), phosphorus (P), and potassium (K), which supplements plant growth. Compared to synthetically composed commercial fertilizers, next generation fertilizers are manufactured from low-energy mechanisms and are composed of nutrients from repurposed wastes which make them cost-efficient and sustainable. With the objective of determining which would deem to be an effective next generation fertilizer, we focus on human urine and meat and bone meal, to which its processing included solar drying, freezing, grinding, and utilizing additives to prevent fungal growth as well as improve efficacy. Three iterations, each with four set ups: plain urine, urine and meat and bone meal, control, and meat and bone meal only; were used to examine which content would prove more beneficial to the growth and quality of the chosen plant, *Vigna radiata*. The study adapted a quantitative analysis that aimed to measure the plant height, leaf area index, and dark green color index through the conduction of statistical tests and the use of ImageJ. As a result, the paper was able to conclude that the combination of urine and meat and bone meal poses a great potential for future fertilizer use.

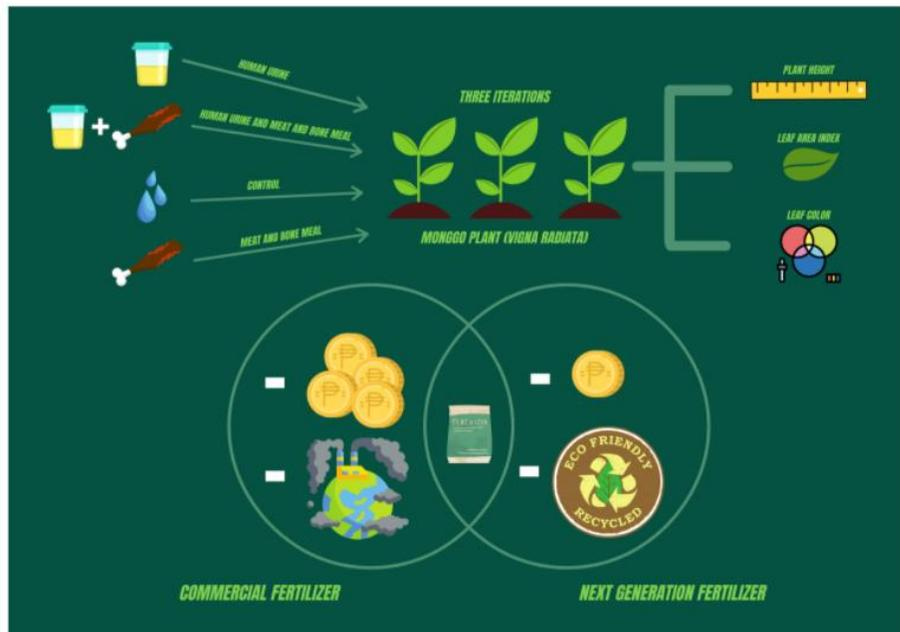

Figure 1. Graphical Abstract

Key Words: Next generation fertilizer; human urine; meat and bone meal; vigna radiata

1. INTRODUCTION

Compared to synthetically composed commercial fertilizers, next generation fertilizers are manufactured from low-energy mechanisms and are composed of nutrients from repurposed wastes. They are better in terms of nutrient use efficiency (NUE) which have a potential boost in crop productivity and quality in the future as sources of plant nutrients. Its capability to bridge the imbalanced use and nutrient gap generated by their synthetic counterpart in soil is one of the reasons why it is better than commercial fertilizers (Singh, Praharaj, & Jat, 2019).

The study was conducted by developing crop-specific formulae from human urine and meat and bone meal, both organic materials for cost-efficiency and accessibility. Urine, an exemplar of human excreta, defined as a liquid output produced by the kidneys, contains significant amounts of nitrogen (N), phosphorus (P), potassium (K), and other micronutrients (Nagi & Zseni, 2017). Processed from slaughterhouse waste, the meat and bone meal comprises concentrations of N, P, and calcium (Ca). Thus, both possess the essential nutrients necessary for plant growth (Möller, 2015). With next generation fertilizers, one can cut costs since its vital component is human urine which is free and always readily available. As farmers do not have a considerable budget for planting crops, the fertilizer would be able to assist them in their finances. Moreover, as COVID-19, a massive health threat in the country, continues to warrant quarantine protocols leading to a multitude of people remaining in their homes, we thus investigate how households can use their excrement and readily available household ingredients to grow their own foods.

Considering the mechanisms of nutrient delivery, this study aims to determine which and what constituent would be deemed the most effective and beneficial to the chosen plant subject, *Vigna radiata*, also known as the monggo plant. Additives such as sodium bicarbonate (NaHCO_3) were utilized to generate a slow-release fertilizer that prevents fungal growth in plants and enhances efficacy (Jamilah et al., 2020).

2. METHODOLOGY

The urine's pH level was accounted for by using a pH meter and was subjected to a freeze-thaw process for further stabilization. If the pH level did not meet the preferred value of around 6.8, the addition of $\text{Ca}(\text{OH})_2$ was employed. Urine was stored in a sealed container, placed inside a cooler with ice and salt that was replenished every two hours. It was kept inside for seventy-two hours before it was thawed at room temperature. For the meat and bone meal, it was first subjected to boiling for an hour to soften its structure.

Afterwards, ample amounts of boiled meat

and bone meal were blended which resulted in a paste-meal component. When under high temperatures, organic matter retains its minerals, such as phosphorus (Möller, 2015). The meat and bone meal supplements the plant with phosphorus that the urine lacks. Both the processed urine and meat and bone meal were mixed and once diversified, was transferred to a drying pan, covered with a plastic lid, and solar dried for forty-eight hours. Subsequently, the product produced was a paste fertilizer. It was then stored in a sealed container and placed in a cool and dry place. All equipment used were identical and purchased from the same shops.

A randomized block design consisting of four set-ups of monggo plants per block was used to gauge the fertilizer's effectiveness. The dependent variables in this study were the plant height, leaf area index, and leaf color of the plant while the independent variable was the fertilizer, which was separated into four groups: Set-up A, Set-up B, Set-up C, and Set-up D. Set-up A was a monggo plant fertilized with a controlled amount of urine fertilizer; Set-up B was fertilized with the product from the mixture of urine and meat and bone meal while Set-up C was not fertilized at all. This distinction also acted as the baseline or controlled set-up for the comparison of data. Meanwhile, Set-up D was fertilized with meat and bone meal only. All set-ups were situated indoors with direct access to sunlight. Each set-up has 100 grams of soil and were situated in identical pots. A total of three iterations, which is defined as a process modification, with each iteration having two trials were done during the study. Three iterations were conducted since this a novel project; and so the procedures incorporated in the methodology such as the mix formulation and application will solely be dependent on the successes and failures of the preceding iterations.



Figure 2.1 General Procedure

Table 2.1 Summary of All Iterations

	First Iteration	Second Iteration	Third Iteration
Set-up A (Urine Only)	50 grams	10 grams	70 grams
Set-up B (Urine and Meat)	50 grams	10 grams	70 grams
Set-up C (Control)	-	-	-
Set-up D (Bone and Meat only)	50 grams	10 grams	70 grams
Water	50 mL	10 mL	25 mL
Baking Soda	13.6 grams	10 grams	-
Frequency	Everyday for one week	Once every 3 days for four weeks	Once in five weeks
Soil	100 grams	100 grams	200 grams
Data to be collected	Potential revisions	Plant height	Leaf area index, color, and plant height

One-way ANOVA was utilized in analyzing the data for plant height collected from the experiment because the researchers aimed to differentiate the results and test whether the differences within the means of the data were significant. For the leaf area index and color, the software ImageJ was used. ImageJ is an open-source imaging software that offers an estimate of real-life dimensions of given pictures of objects by measuring the number of pixels it has in comparison to an object with a known measurement. In terms of the color, a plugin made by NC State University for ImageJ was utilized in order to measure the leaves' dark green color index which includes saturation, brightness values, and hue angle (Zhang, Pinnix, Zhang, Miller, & Rufty, 2017). Leaf samples were collected from the set-ups at the end of the experiment period and were photographed, edited, and ran through the program.

Figure 2.2 ImageJ Interface

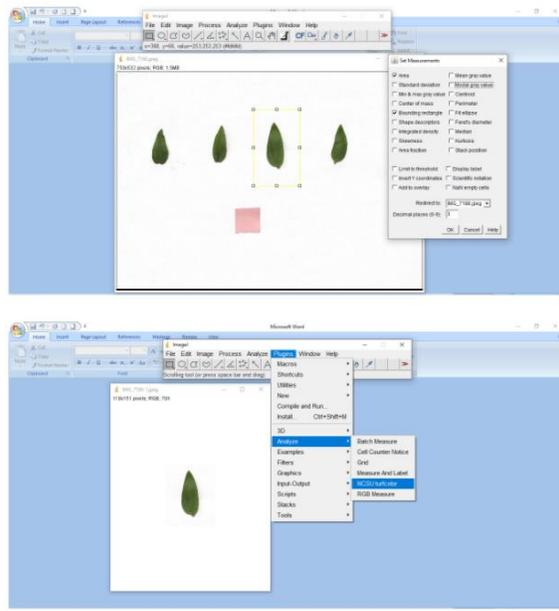

For the leaf area index and color, mean values were utilized since the sample size was too small to conduct a one-way ANOVA test (Tabachnik & Fidell, 2012).

3. RESULTS AND DISCUSSION

Table 3.1 Summary of Recorded Mean Values of Parameters

	Set-up A	Set-up B	Set-up C	Set-up D
Final Plant Height (Second Iteration)	20.1 cm	19.2 cm	19.15 cm	18.65 cm
Final Plant Height (Third Iteration)	18.6 cm	26.9 cm	20.9 cm	22.5 cm
Final Leaf Area (Third Iteration)	5.73cm ²	6.87cm ²	4.57cm ²	4.8 cm ²
DGCI Mean (Third Iteration)	0.373	0.396	0.361	0.333

Figure 3.1 Documentation of all Fertilizer Set-ups in the Third Iteration

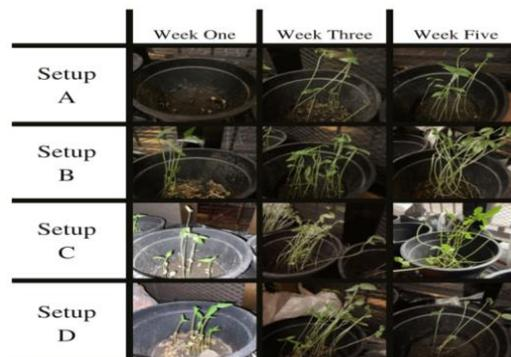



The first iteration was conducted as preliminary grounds only to test out the feasibility of using urine and meat and bone meal as a component for a next generation fertilizer. At the end of the experimental period, the urine and meat and bone meal fertilizer has shown to have the highest final plant height, and is thus the most effective out of all fertilizers.

For the second iteration, a change in the increments of fertilizer, baking soda, and water was made based on ocular observations from the first iteration. The one-way ANOVA testing conducted showed that the P-value for the means of plant height between the groups has a value of 0.50. Since it has exceeded the 5% significance level, we can infer that the difference between the means was not statistically significant. Despite this conclusion on the test, we can infer that Set-up A, with the urine-only fertilizer, is the plant with the most effective fertilizer during the second iteration given that it has the highest final plant height. A possible reason why the urine-only fertilizer became the most effective in terms of plant growth can be attributed to the addition of sodium bicarbonate into every fertilizer application. According to Gafter, Edelstein, and Levi (1985), sodium bicarbonate can inhibit the absorption of the nutrient phosphorus. Since the meat and bone meal component of the fertilizers was supposed to mostly supplement the phosphorus demand of the plants, the large amount of sodium bicarbonate may have nullified the effectiveness of all fertilizers containing meat and bone meal. Another potential factor to its boosted effectivity is that human urine is better suited for multiple applications, since fertilizing before the plant's seedling stage is not effective for plant growth and production due to mainly high ions intensity in low saline soil and high leaching of nutrients from soil (Sene, 2013).

For the third iteration, the one-way ANOVA testing conducted showed that the P-value for the means of plant height between the groups has a value of 0.08. Since it has exceeded the 5% significance level, we can infer that the differences between the means were not statistically significant. Despite this conclusion on the test, we can infer that Set-up B, with the urine and meat and bone meal fertilizer, is the plant with the most effective fertilizer during the third iteration given that it has the highest final plant height. The data collected were also in line with the tentative hypothesis formulated by the researchers which states that the addition of sodium bicarbonate may have disrupted the effectiveness of the meat and bone meal component of the fertilizers which contain it during the second iteration. Furthermore, it was found out that the most effective and low-maintenance method for mixed component fertilizers would be to have a one-time application; in a similar study that

was conducted with maize, it was concluded that higher meat and bone meal doses contributed to a higher grain yield and that the yield-forming effect of meat and bone meal was not dependent on the frequency of application (Nogalska et al., 2013).

Leaf color is an indicator of the nitrogen level present in a plant. In line with the values presented in the table, we can infer that fertilizer Set-up B had the biggest leaf area index and highest dark green color index (DGCI) mean. In a study by Siddons (2013), the DGCI of a plant was utilized as a method to measure the nitrogen content of several plants. In the wheat and turf that was examined in the study, it was detected that its DGCI values and leaf N concentration have a strong relationship. A higher DGCI value indicated a higher amount of N present. Therefore, based on this, as fertilizer set-up B had the highest DGCI mean of 0.396, we can infer that it contains the most amount of N. Since the population for both DGCI and leaf area was too small, it was not possible to have it undergo ANOVA testing.

4. CONCLUSIONS

In this study, amidst the four fertilizer set-ups, the researchers learned that the fertilizer for set-up B, which contained combined urine and meat and bone meal, poses the greatest potential as a next generation fertilizer. Baking soda may accompany urine itself, but an alternative may be needed when it is needed to be mixed alongside phosphorus-rich components such as meat and bone meal. Furthermore, after conducting three different ways of applying the fertilizers, the researchers were able to determine that the most effective and low-maintenance method is to utilize a one-time application when using a mixed component fertilizer. On the other hand, when using urine-only fertilizer, it is preferable to utilize a slow-release mechanism with the use of an additive.

The differences between the means of plant heights in the second and third iterations were found to be not statistically significant. However, comparing the raw data to one another will infer an evident difference that can corroborate the high possibility of developing a next generation fertilizer from urine and meat and bone meal once further research, enhanced methodologies and instruments are incorporated.

The experimental part of this study was unfortunately conducted during the implementation of quarantine measures in the country because of COVID-19; therefore the researchers had limited resources. For further research similar to a novel project such as this, the researchers recommend that consistency of the location, materials, and equipment must be maintained in producing a next generation fertilizer to provide more cohesive and solid results. It is also recommended to cover a wider array of



parameters that the researchers were not able to measure such as number of leaves, number of roots and the exact NPK demand of the plant and the soil to be used. Another type of plant, preferably one with a longer growth cycle is apt for this kind of study so that there are more results to be obtained and analyzed. When using a slow-release mechanism, baking soda is not advisable to be used upon phosphorus-rich components as it may potentially disrupt the phosphorus delivery of the fertilizer. Lastly, to corroborate a fertilizer's effectiveness as a next generation fertilizer, conduct a study comparing it with a commercial fertilizer.

5. ACKNOWLEDGMENTS

The utmost gratitude and appreciation are extended to the following people for their unbounding help and support for the researchers during the time of the creation of their study:

De La Salle University Manila, the researchers' university, through providing partial funding and academic resources to the researchers as well as giving them proficient lecturers and professors in order for them to further cultivate their research skills.

Ms. Liezl Rillera-Astudillo, the SHS research coordinator for STEM, for her patience in delegating messages and essential information to and from the researchers and their intended recipients.

To the Researchers' Family Members, for their understanding, tolerance, and assistance to the experiments conducted at their homes, the sleepless nights their households endured for the sake of reaching deadlines, and the overall emotional sustenance they have provided the researchers with whenever they have felt disappointment, confusion, and failure.

6. REFERENCES

Achakzai, A. et al. (2012). Effect of nitrogen fertilizer on the growth of mung bean [*Vigna radiata* (L.) Wilczek] grown in Quetta. *Pak. J. Bot.*, 44(3), 981-987. Retrieved December 23, 2020, from [https://www.pakbs.org/pjbot/PDFs/44\(3\)/21.pdf](https://www.pakbs.org/pjbot/PDFs/44(3)/21.pdf)

Andreev, N. et al. (2017). Lactic acid fermentation of human urine to improve its fertilizing value and reduce odour emissions. *Journal of Environmental Management*, 198(1), 63-69. <https://doi.org/10.1016/j.jenvman.2017.04.059>

Axe, J. (2017). What are nitrates? Reasons to avoid nitrates (and better alternatives). <https://draxe.com/nutrition/nitrates/>

Bachik N.A. et al. (2017). The determination of nitrogen value at various reading points on rice leaf using RGB imaging. *Acta Horticulturae*, (1152), 381-386. <https://doi.org/10.17660/actahortic.2017.1152.51>

Beganovic, J., Kos, B., Lebos Pavunk, A., Jokic, M., & Suskovic, J. (2014). Traditionally produced sauerkraut as source of autochthonous functional starter cultures. *Microbiol. Res*, 169, 623-632. <https://doi.org/10.1016/j.micres.2013.09.015>

Bouatra S. et al. (2013). The Human Urine Metabolome. *Encyclopædia Britannica*. Retrieved June 17, 2020, from <https://www.britannica.com/topic/meat>

Chen, J., Lu, S., Zhang, Z., Zhao, X., Li, X., Ning, P., & Liu, M. (2018). Environmentally friendly fertilizers: a review of materials used and their effects on the environment. *Science of the Total Environment*, 613-614, 829-839. <https://doi.org/10.1016/j.scitotenv.2017.09.186>

Chipako, T. & Randall, D. (2019). Urine treatment technologies and the importance of pH. *Journal of Environmental Chemical Engineering*, 8(1). <https://doi.org/10.1016/j.jece.2019.103622>

Department of Agriculture, Forestry, & Fisheries of Republic of South Africa (2010). Mung bean production guideline [PDF File]. <https://www.daff.gov.za/docs/Brochures/MbeanpGUEDELINS.pdf>

Fresenius Kidney Care (2020). 6 common chronic kidney disease medications. <https://www.freseniuskidneycare.com/kidney-disease/managing-ckd/medications>

Gafter, U., Edelstein, S., & Levi, J. (1985). Effect of Bicarbonate Feeding on Intestinal Absorption of Calcium and Vitamin D Metabolism in Rats. *Clinical Science*, 68(1), 97-100. <https://doi.org/10.1042/cs0680097>

Ganrot, Z., Dave, G., & Nilsson, E. (2007). Recovery of N and P from human urine by freezing, struvite precipitation and adsorption to zeolite and active carbon. *Bioresource Technology*, 98(16), 3112-3121. <https://doi.org/10.1016/j.biortech.2006.10.038>

Gensch, R., Itchon, G., & Miso, A. (2011). Urine as liquid fertilizer in agricultural production in the Philippines: A practical field guide. Cagayan de Oro City: Xavier University Press.

Gessellschaft, F. (2015). Meat and bone meal as a source of phosphorus. <https://phys.org/news/2015-12-meat-bone-meal-source-phosphorus.html>

Hashemi, S. & Han, M. (2017). Methods for controlling stored urine odor in resource-oriented sanitation. *Journal of Water, Sanitation, and Hygiene for Development*, 507-514. <https://doi.org/10.2166/washdev.2017.098>

Hashemi, S. & Han, M. (2019). Field evaluation of the fertilizing potential of biologically treated sanitation products. *Science of the Total Environment*, 650, 1591-1598. <https://doi.org/10.1016/j.scitotenv.2018.09.009>

Hou, D., Yousaf, L., Xue, Y., Hu, J., Wu, J., Hu, X., Feng, N., & Shen, Q. (2019). Mung Bean (*Vigna Radiata* L.): Bioactive polyphenols, polysaccharides, peptides, and health Benefits. *Nutrients*, 11.6, 1238-. <https://doi.org/10.3390/nu11061238>

Ison, L. (2020, June 28). Data shows high price of fertilizer prior to centralized bidding. Retrieved January 19, 2021, from [https://www.pna.gov.ph/articles/1107299#:~:text=Based%20on%20data%20released%20by,PHP1%20C029.98%20\(June\)](https://www.pna.gov.ph/articles/1107299#:~:text=Based%20on%20data%20released%20by,PHP1%20C029.98%20(June))

Jagtap, N. & Boyer, T. (2018). Integrated, multi-process approach to total nutrient recovery from stored urine. *Environmental Science: Water Research and Technology*, 4, 1639-1650. <https://doi.org/10.1039/c8ew00004b>

Jamilah et al. (2020). Effects of biochar and chromolaena odorata liquid fertilizer enriched with sodium bicarbonate on soil and muskmelon (*Cucumis melo* L.). *Planta Tropika: Jurnal Agrosains (Journal of Agro Science)*, 8 (1). <https://doi.org/10.18196/pt.2020.108.7-14>

Jara-Samaniego, J., et al. (2017). Development of organic fertilizers from food market waste and urban gardening by composting in Ecuador. *Plos One*, 12(7). <https://doi.org/10.1371/journal.pone.0181621>

Jayathilakan, K. et al. (2012). Utilization of byproducts and waste materials from meat, poultry and fish processing industries: a review. *Journal of Food Science and Technology*, 49(3), 278-293. <https://doi.org/10.1007/s13197-011-0290-7>

Jeng, A. et al. (2006). Meat and bone meal as nitrogen and phosphorus fertilizer to cereals and rye grass. *Nutrient Cycling in Agroecosystems*, 76, 183-191. <https://doi.org/10.1007/s10705-005-5170-y>

Kirchmann, H., Pettersson, S. (1995). Human urine-chemical composition and fertilizer use efficiency. *Nutr. Cycl. Agroecosyst*, 40, 149-154. <https://doi.org/10.1007/bf00750100>

Lind, B., Ban, Z., & Bydén, S. (2001). Volume reduction and concentration of nutrients in human urine. *Ecological Engineering*, 16(4), 561-566. [https://doi.org/10.1016/s0925-8574\(00\)00107-5](https://doi.org/10.1016/s0925-8574(00)00107-5)



- Mawis, S. (2019, May 18). Solid waste mismanagement in the Philippines. *Business Inquirer*. <https://business.inquirer.net/270819/solid-waste-mismanagement-in-the-philippines>
- Mayuga, J. (2020, February 5). PHL only has 10 percent of needed sanitary landfills, says DENR exec. *Business Mirror*. <https://businessmirror.com.ph/2020/02/05/phl-only-has-10-percent-of-needed-sanitary-landfills-says-denr-exec/>
- Moncel, B. (2020, November 4). What is baking soda? <https://www.thespruceeats.com/what-is-baking-soda-p2-1328637>
- Möller, K. (2015). Assessment of alternative phosphorus fertilizers for organic farming : meat and bone meal [PDF File]. <https://orgprints.org/29505/1/moeller2015-factsheet-Meat-and-bone-meal.pdf>.
- Nagy, J. & Zseni, A. (2017). Human urine as an efficient fertilizer product in agriculture. *Agronomy Research*, 15, 490-500.
- Nogalska, A. et al. (2013). The effect of increasing doses of meat and bone meal (MBM) applied every second year on maize grown for grain. *Chilean Journal of Agricultural Research*, 73(4). <http://dx.doi.org/10.4067/S0718-58392013000400015>
- O.K, N., Niyokuri, A.N., Rono, J.J., Fashaho, A., & Ogweni, J.O.. Effect of different rates of nitrogen fertilizer on the growth and yield of zucchini (Cucurbita pepo cv. Diamant L.) Hybrid F1 in Rwandan high altitude zone. *International Journal of Agricultural and Crop Sciences*, 5, 54-62. https://www.researchgate.net/publication/303150166_Effect_of_different_rates_of_nitrogen_fertilizer_on_the_growth_and_yield_of_Zucchini_Cucurbitapepocv_Diamant_L_hybrid_F1_in_Rwandan_high_altitude_zone
- Okareh, O. T., Oyewole, S. A., & Taiwo, L. B. (2014). Conversion of Food Residuals to Organic Fertilizer: A Strategy for Promoting Food Security and Institutional Waste Management in Nigeria. *Journal of Research in Environmental Science and Toxicology*, 3(4), 66-72. https://www.researchgate.net/publication/266905536_Conversion_of_Food_Residuals_to_Organic_Fertilizer_A_Strategy_for_Promoting_Food_Security_and_Institutional_Waste_Management_in_Nigeria
- Plant Care Today (2021). 30 ways to use natural baking soda in the garden. <https://plantcaretoday.com/baking-soda-garden-uses.html>
- Pradhan, S., Holopainen, J., & Heionen-Tanski, H. (2009). Stored Human Urine Supplemented with Wood Ash as Fertilizer in Tomato (Solanum lycopersicum) Cultivation and Its Impacts on Fruit Yield and Quality. *Journal of Agricultural and Food Chemistry*, 57, 7612-7617. <https://doi.org/10.1021/jf9018917>
- Pronk, W. & Kone, D. (2008). Options for urine treatment in developing countries. *Desalination* 248, 360-368. <https://doi.org/10.1016/j.desal.2008.05.076>
- Raper, E., Fisher, R., Anderson, D. R., Stephenson, T., & Soares, A. (2018). Alkalinity and external carbon requirements for denitrification-nitrification of coke wastewater. *Environmental Technology*, 39(17), 2266–2277. <https://doi.org/10.1080/09593330.2018.1437779>
- Samanthi (2018, December 13). Difference between lycopene and beta carotene. <https://www.differencebetween.com/difference-between-lycopene-and-beta-carotene/#Beta%20Carotene>
- Schnug, E. (2005, August 29). The use of meat and bone meal as organic farming fertiliser. <https://www.thepigsite.com/articles/the-use-of-meat-and-bone-meal-as-organic-farming-fertiliser>
- Sene, M. (2013). Application of human urine as liquid fertilizer in agriculture. [PDF File]. Hokkaido University Collection of Scholarly and Academic Papers, 56. https://eprints.lib.hokudai.ac.jp/dspace/bitstream/2115/53892/1/Sene_Moustapha.pdf
- Shiel Jr., W. (2018, December 27). Medical definition of urine. https://www.medicinenet.com/urine_pee_health_color_odor_uri_nalysis/article.htm
- Siddons, U. (2013). Dark Green Color Index as a Method of Real-Time in-Season Corn Nitrogen Measurement and Fertilization [PDF file]. 78-79. <https://core.ac.uk/download/pdf/72842769.pdf>
- Speake, C. (2013). 20 clever uses for baking soda in the garden – make life easy! <https://thegardeningcook.com/baking-soda-in-the-garden/>
- Tabachnick, B. G. & Fidell, L. S. (2012). *Using multivariate statistics* (6th ed.). Boston, MA: Pearson.
- Udernt, K.M, Larsen, T.A., & Gujer, W. (2006). Fate of major compounds in source-separated urine. *Water Sci. Technol.* 54, 413-420. <https://doi.org/10.2166/wst.2006.921>
- U.S. National Library of Medicine (2021). Urine 24-hour volume. <https://medlineplus.gov/ency/article/003425.htm#:~:text=The%20normal%20range%20for%2024,about%20%20liters%20per%20day>
- Wang, Y., Wang, D., Shi, P., & Omasa, K. (2014). Estimating rice chlorophyll content and leaf nitrogen concentration with a digital still color camera under natural light. *Plant Methods*, 10, 36. <https://doi.org/10.1186/1746-4811-10-36>
- Walden, A. (2021). The differences between quick-release and slow-release fertilizers. <https://ashtonwalden.com/the-differences-between-quick-release-and-slow-release-fertilizers/#:~:text=Quick%2DRelease%20Fertilizers,rapid%20growth%20on%20new%20lawns.>
- World Health Organization. (2020). Coronavirus. https://www.who.int/health-topics/coronavirus#tab=tab_1
- Yin, Z., Guo, W., Xiao, H., Liang, J., Hao, X., Dong, N., ... Yin, F. (2018). Nitrogen, phosphorus, and potassium fertilization to achieve expected yield and improve yield components of mung bean. *PLOS ONE*, 13(10). <https://doi.org/10.1371/journal.pone.0206285>
- Zhang, C., Pinnix, G. D., Zhang, Z., Miller, G. L., & Ruffy, T. W. (2017). Evaluation of Key Methodology for Digital Image Analysis of Turfgrass Color Using Open-Source Software. *Crop Science*, 57(2), 550. <https://doi.org/10.2135/cropsci2016.04.0285>



Development of a Cost-effective Microbial Fuel Cell (CEMFC) to Generate Electricity from Carbohydrate Food Waste

Phoebe Anne V. San Pablo, Ji Seok Lee, Chynna Celestine C. Amol, Sebastian Dimitri M. Llamas, Rafael Angelo R. Palamos, Allaine Antoinette R. Panlilio, Ivan Miguel C. Raymundo, Ryan Lorenzo S. Vasquez, Jose M. Calamlam, and Gerald B. Gamboa
De La Salle Santiago Zobel School - Vermosa Campus, Imus City, Cavite

Abstract: Due to the ever-increasing demand for electricity and the growing solid waste management problem prevalent in the Philippines, there exists a need for an innovation that can solve both problems simultaneously while being accessible to impoverished households. This study investigated the effectiveness of utilizing accessible materials such as earthenware ceramic, baking soda, charcoal, and food waste in developing a Cost-effective Microbial Fuel Cell (CEMFC). Eight prototypes were created using such materials, with 7 having the anode wrapped around the PEM and one having the anode placed around the inside of the container. The voltage output and duration were measured after which the performance of the uniform prototypes was compared with the varying prototypes, as well as that of a commercial battery. The effects of the placement of the anode on the efficiency of the fuel cells were also investigated by creating two prototype models. The results were analyzed with the application of an Independent t-Test and MANOVA. The mean voltage produced by the uniform CEMFCs was 0.21 Volts and the average duration of all the prototypes was 14 days. The prototypes also had a lower efficiency compared to a commercial battery (p -value < 0.05), however no significant difference was observed on the two prototype variations made based on the position of the bioanode (p -value = 0.5740). It was concluded that while the CEMFC was able to produce electricity, the voltage generated wasn't enough to fully power devices, thus further studies regarding scaling up methods for higher electricity production is recommended.

Key Words: cost-effective microbial fuel cell; anode; voltage; duration; bioanode

1. INTRODUCTION

Electricity, despite being a fundamental human right, is not readily available to millions of people in Southeast Asia. According to Rosario (2019), in the Philippines alone, 13 to 16 million people have no access to electricity. Moreover, these people can usually be found in rural or underdeveloped areas, making it more difficult for them to receive the help they need due to the lack of facilities and resources in their location. The efforts of the nation's main energy provider, Meralco Corporation, on increasing the number of coal power plants to meet the population's electricity needs prove to be both insufficient and detrimental to the environment (Domingo, 2019). Similar to many third world countries, the Philippines also faces the issue of solid waste management, either due to the lack of proper disposal facilities or inefficient waste processing techniques ("Philippines Solid Waste at a Glance", 2017).

Microbial fuel cells (MFC) are a type of emerging technology which utilizes the ability of bacteria to release protons and electrons from organic molecules through an oxidation process (Wen et al.,

2010). Multiple studies have already investigated various factors that may affect the performance of an MFC including the presence of a magnetic field, difference in pH levels, and the use of a polyaniline sponge as an anode (Sun et al., 2017; Xu et al., 2018; Yin et al., 2016). Despite this, none of the studies mentioned sought to create a cost-effective MFC. There is also a knowledge gap with regards to the effects of the placement of the anode as similar research studies were only concerned with investigating electrode treatments that can help increase the efficiency of the MFC as opposed to studying specific parameters that may affect its performance. Consequently, this study aimed to develop a Cost-effective Microbial Fuel Cell (CEMFC) with the utilization of the following independent variables: (i) ceramic as a cation separator, (ii) charcoal as a bioanode, (iii) baking soda as pH regulator, and (iv) ground carbohydrate food waste mixed with water as a substrate. The efficiency of the created prototypes served as the dependent variable which was measured with the use of two parameters, namely voltage and duration. The researchers also

investigated the effects of the placement of the anode on the performance of the CEMFC.

2. Literature Review

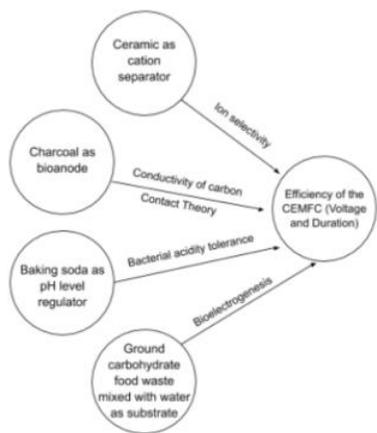

Figure 1. Conceptual Framework

The utilization of ceramic as a cation separator, charcoal as a bioanode, baking soda as a pH regulator, and ground food waste mixed with water as a substrate directly influenced the efficiency of a microbial fuel cell. To elaborate, first, the ion selectivity of a cation separator has proven to be a determining factor concerning its effectiveness. Ion selectivity controls how easily protons will pass through the PEM (Harnish, 2009). Consequently, if the ion selectivity of a cation separator proved to be diverging from the protons present in the anode, a cation build-up may occur; increasing the acidity of the solution, and killing the microorganisms present, rendering the microbial fuel cell inefficient. On the other hand, a porous separator would allow protons to pass more quickly, preventing cation accumulation in the anode (Winfield et al., 2016). Previous studies have proven that ceramic has high porosity and no ion selectivity, making it a preferable material for the PEM (Winfield et al., 2016; Winfield et al., 2013; Pasternak et al., 2016). Second, the conductivity of the anode, as well as the presence of more significant contact among the particles, influence the overall voltage generation efficiency and current measure of a microbial fuel cell, in the sense that more points of contact allow for the formation of a channel for electrons to flow through (Gonzales et al., 2004). Previous studies proved that carbon-based materials including biochar and charcoal have high conductivity when increasing the number of points of contact between each molecule by compacting the charcoal, making it a suitable bioanode material (Cheng & Logan, 2006; Chaijak et al., 2018; Li et al., 2017; Qiao

et al., 2007). Third, bacterial acidity tolerance determines what pH level the anode should have for optimum power generation as some microorganisms may thrive in neutral environments rather than basic or acidic ones (Sun et al., 2019; Biffinger et al., 2008). The voltage output, and duration of a microbial fuel cell have been proven to vary with the microbial communities' activity present, subsequently being affected by the pH levels (Helin et al., 2018). Baking soda has been examined to have basic properties, thus raising pH levels slightly above the neutral mark and below the critical pH level where the bacterial activity starts to decline (Finch, 2017; Mentzer, 2019; Sun et al., 2019). Finally, the electrogenic ability of the microbial colonies present in wastes is the driving force that converts the organic molecules present in substrates to electrical energy via anaerobic digestion (Sivasankar et al., 2018; Raghavulu et al., 2013; Logrono et al., 2015; Kondaveeti et al., 2019). Related studies have discovered that food waste have high COD concentrations as well as carbohydrates, sugars, and phenolics, making it a viable substrate to foster the growth and digestion of nutrients of microbial communities in a microbial fuel cell (Socaci et al., 2017; Lin et al., 2013; Paritosh et al., 2017; Farcas et al., 2017).

2. METHODOLOGY

2.1 Research Design

The researchers utilized the factorial design under the experimental structure in the study. This allowed them to collectively investigate the effects of the following independent treatments on the dependent variable: (i) ceramic as cation separator, (ii) charcoal as a bioanode, (iii) baking soda as pH regulator, and (iv) ground food waste mixed with water as a substrate.

2.2 Data Gathering Procedure

The researchers conducted the data gathering procedure by creating 8 MFC prototypes, of which 7 had the bioanode wrapped around the PEM while 1 had the anode wrapped around the inside of the container.

2.2.1 Preparation and Acquisition of Materials

The researchers accomplished the Research Ethics Checklist given to them and had the letter of approval to perform the experiment signed by the research head prior to the conduction of the experiment. The materials were sourced from online stores and local markets as the researchers could no longer gather the samples and items needed from the partner community due to the restriction imposed by the pandemic.



2.2.2 Construction of CEMFC Prototypes

The researchers ground the carbohydrate food waste collected prior to the assembly of the prototype. The earthenware ceramic pot was placed in the middle of the plastic container. After which the charcoal was mixed with flour paste and molded around the inside of the container for one of the prototypes and around the outside of the pot for the rest of the CEMFCs until a thickness of 1 cm was achieved. A steel mesh placed inside the earthenware pot served as the cathode. The voltage output of each of the 8 CEMFC units was measured at a time interim of 30 minutes via a multimeter. The researchers then determined the duration by computing the interval where the MFC is producing electricity. The voltage values gathered concerning the level of time were averaged once complete. The same procedure was done with a commercial battery, after which the researchers compared the data collected from the two set-ups.

3.2.3 Application of Statistical Treatment

After the conduction of the experiment, the researchers properly disposed of the materials used so as to prevent contamination. The data gathered were recorded, sorted, and tabulated prior to the conduction of data analysis.

3.3 Data Analysis

The data gathered by the researchers was analyzed with the application of an independent samples t-Test and Multivariate Analysis of Variance (MANOVA). This allowed the researchers to investigate the existence of a significant difference in the efficiency or performance of the CEMFC and that of a commercial battery, as well as determine if there was a variation in the duration of the control and experimental group prototypes.

3.4 Research Locale

The researchers conducted the entire research experiment, including the grinding of the food waste sample, the compaction of charcoal powder, the construction of the CEMFC, pH regulation, and operation of the CEMFC prototypes, in their respective venues due to the restrictions imposed by the COVID-19 pandemic. The materials were sourced from online retailers.

3. RESULTS AND DISCUSSION

The following data were gathered in line with the experiment performed:

Amount of voltage produced with the utilization of independent variables such as ceramic

as cation separator, charcoal as bioanode, ground carbohydrate food waste mixed with water as a substrate, and baking soda as pH regulator much as possible occupy only one column page. Table headings should be re-indicated for catenated tables.

Table 1. Summary of the Day-to-day Mean Voltage Output of Each Prototype

	1	2	3	4	5	6	7	Vary
Day 1	0.191	0.004	0.1	0.003	0.003	0.164	0.0	0.4837
Day 2	8	9					12	
Day 3	0.392	0.021	0.14	0.011	N/A	0.637	0.0	0.3382
Day 4	2	3	2				2	
Day 5	0.532	0.023	0.197	0.03	N/A	0.7	0.0	0.2615
Day 6	0.344	0.066	0.275	0.044	N/A	0.595	0.0	0.2867
Day 7	0.348	0.079	0.35	0.023	N/A	0.547	DP	0.09
Day 8	1	7						
Day 9	0.387	0.101	0.405	0.012	N/A	0.57	DP	0.0633
Day 10	9	2						
Day 11	0.393	0.123	0.508	0.055	N/A	0.517	DP	0.1214
Day 12	0.398	0.148	0.4	0.015	N/A	0.485	DP	0.0723
Day 13	8	9	5					
Day 14	0.258	0.169	0.3	0.023	N/A	DP	DP	0.0336
Day 15	1	6						
Day 16	0.147	0.181	0.27	0.025	N/A	DP	DP	0.0242
Day 17	8	7						
Day 18	0.099	0.225	0.08	0.038	N/A	DP	DP	DP
Day 19	1	4						
Day 20	DP	0.249	DP	0.038	N/A	DP	DP	DP
Day 21	12	3						
Day 22	DP	0.259	DP	0.009	N/A	DP	DP	DP
Day 23	7							
Day 24	DP	0.289	DP	0.023	N/A	DP	DP	DP
Day 25	14	9						
Day 26	DP	0.283	DP	0.038	N/A	DP	DP	DP
Day 27	15	8						
Day 28	DP	0.283	DP	0.049	N/A	DP	DP	DP
Day 29	16	1						
Day 30	DP	0.282	DP	0.08	N/A	DP	DP	DP
Day 31	17	7						
Day 32	DP	0.282	DP	0.06	N/A	DP	DP	DP
Day 33	18	7						
Day 34	DP	0.255	DP	0.057	N/A	DP	DP	DP
Day 35	19	1						
Day 36	DP	0.214	DP	0.075	N/A	DP	DP	DP
Day 37	20	4						
Day 38	DP	0.167	DP	0.163	N/A	DP	DP	DP
Day 39	21	2						
Day 40	DP	DP	DP	0.027	N/A	DP	DP	DP
Day 41	22							
Day 42	DP	DP	DP	0.862	N/A	DP	DP	DP
Day 43	23							
Day 44	DP			0.21 V				0.18 V

Table 1 shows that the average voltage produced by the uniform MFC prototypes is 0.21 V, while the varying prototype produced a mean of 0.18 V. Additionally, most of the prototypes had an inconsistent voltage production in which the electricity being produced would either slightly increase before gradually decreasing or significantly increase before plunging. Such results are in line with similar research studies cited in the paper. For instance, it was proven by Winfield et al. (2016) that ceramic's porosity makes it a preferred material for proton exchange membranes as it allows protons to pass through it easily while also providing a positive environment for the metabolism of electro-active microorganisms. An earthenware type of ceramic was also discovered to help yield the highest amount of overall MFC productivity compared to mullite, pyrophyllite, and alumina (Pasternak et al., 2016).

Table 2. Approximate Maximum Mean Voltage Produced by Each CEMFC Prototype

Prototype #	Maximum Voltage output / Peak of Voltage Output	Minimum Voltage Output
1	0.532	0.099
2	0.290	0.005
3	0.508	0.08
4	0.862	0.003
5	0.003	0.003
6	0.637	0.164
7	0.028	0.012
Vary	0.484	0.024



Table 2 shows that the uniform MFCs also varied in their average maximum and minimum voltage production, with the highest data recorded being 0.862 V and the lowest, 0.003 V. Subsequently, the varying prototype had an average maximum voltage of 0.484 V and a minimum of 0.024 V. The overall voltage production capability of the fuel cell could be inferred as a result of the feasibility of the said low-cost materials to be used in MFCs. For instance, it was studied that the application of a carbon material as a bioanode, can increase the electricity production capacity of an MFC (Winfield et al., 2016; Pasternak et al., 2016; Sun et al., 2018).

Average duration of the uniform prototypes with respect to the utilization of ceramic as cation separator, charcoal as bioanode, ground carbohydrate food waste mixed with water as a substrate, and baking soda as pH regulator.

Table 3. Summary of the Duration or Lifespan of the Individual CEMFC Prototypes

MFC #	# of Days Active
1	11
2	21
3	11
4	23
5	ins. Data
6	8
7	3
Average	13

Table 3 shows that the researchers determined that control group 2 lasted the longest for a total of 21 days, followed by control group 1 for a total of 11 days, while the experimental group lasted a total of 10 days. All 3 groups averaged a total of 14 days of voltage production. This is similar to the findings of previous studies which stated that an average MFC lasts for about a few days to a few months considering the stability of the biocatalysts present (Wang & Jia, 2007).

Table 4. Multivariate Test: Wilks Lambda

Effect	Value	F	Significance
Duration	.000	180262.757	.000
Duration*Group	.000	4828.622b	.000

Table 4 shows that a significant difference in the duration of the three groups was also discovered (p-value < 0.05). Such a variation may be due to the slight fluctuation in temperature of the research environments or a change in pH level (Mano et al., 2002; Sun et al., 2018). The behavior exhibited by the prototypes is also in line with the findings of similar research that longer-lasting MFCs produce less voltage and vice versa (Li, 2013).

Significant difference between the efficiency (voltage) of a CEMFC and the performance of a commercial battery

Table 5. Independent t-Test Analysis Between the CEMFC Prototypes and the Commercial Battery

	Mean of Uniform Prototypes	Voltage from Commercial Battery
Mean	0.211412742	1.735
Variance	0.025229298	0
Observations	23	4
Hypothesized Mean Difference	0	
df	22	
t Stat	-46.00220699	
P(T<=t) one-tail	1.15594E-23	
t Critical one-tail	1.717144374	
P(T<=t) two-tail	2.31187E-23	
t Critical two-tail	2.073873068	

Table 5 shows that based on the independent t-Test analysis, it was determined that the CEMFCs (Mean = 0.2114 V; SD = 0.1588) produced a significantly lower average voltage compared to the commercial battery (Mean = 1.735 V; SD = 0). (t = -46.00; p-value < 0.05). These results could be attributed to an accidental increase in the pH level of the substrate on a select number of prototypes due to the inability of the cation separator to transfer some H⁺ away from the substrate as a result of a great variation in the PEM and substrate volume ratio (Harnisch & Schröder, 2009; Chae et al., 2008; Sun et al., 2018).

Difference in the efficiency of the CEMFC prototypes (voltage and duration) based on the placement of the bioanode

Table 6. Independent t-Test Analysis Between the Two Prototype Variants Based on the Location of the Bioanode

	Mean of Uniform Prototypes	Mean of Varying Prototype
Mean	0.21143478	0.17749
Variance	0.02521698	0.02418709
Observations	23	10
Hypothesized Mean Difference	0	
df	18	
t Stat	0.57253786	
P(T<=t) one-tail	0.28702008	
t Critical one-tail	1.73406361	
P(T<=t) two-tail	0.57404016	
t Critical two-tail	2.10092204	

Table 6 shows that there was no observed significant difference between the voltage production of the MFC prototype variant which had its bioanode wrapped around the PEM (Mean = 0.2114 V; SD = 0.1588), and the voltage output of the MFC prototype which had the bioanode wrapped around the inside of the container (Mean = 0.1775; SD = 0.1555). (t = -0.57; p-value = 0.5740). Consequently, the absence of such difference may be justified by the notion that a minimum distance of 2 cm must be attained for the MFC to reach peak electricity production and both prototype models must have attained the optimal



distance needed (Cheng & Logan, 2006). While it is true that some studies stated that the surface structure and area of the electrode may influence the mass transfer, metabolites, and electron transfer in the MFC, the variations were observed to be trivial in a large scale (Rahimnejad et al., 2015; Yu et al., 2020).

4. CONCLUSIONS

It was evident that while the CEMFC prototypes were able to produce electricity, several factors, among which the placement of the bioanode is not included, still tend to influence the overall performance of the fuel cell. However, given additional development to increase the efficiency of the MFC, there is a high possibility that these fuel cells will eventually be able to become a conventional power source in the future due to its sustainability and cost-effectiveness.

5. ACKNOWLEDGMENTS

The completion of this research could not have been possible without the support and assistance of multiple individuals, whose names may not all be listed. However, the group would like to express their sincerest gratitude and appreciation particularly to the following:

Mr. Alson Garera, Mr. Arsenio Pereras, and Mr. Noel Lobo, the group's engineer consultants, for their support in reviewing the paper and giving suggestions to further improve the study.

Mr. Fritz M. Ferran, for his efforts in teaching the methods of data analysis, as well as the technical aspects of research writing.

To the researchers' families and relatives who provided financial and moral support, thank you.

6. REFERENCES

(2017, November). Philippines Solid Waste at a Glance. Senate Economic Planning Office. https://legacy.senate.gov.ph/publications/lrs_publications.asp

Cheng & Logan (2006). Ammonia treatment of carbon cloth anodes to enhance power generation of microbial fuel cells. *Electrochemistry Communications*, 9(3), 492-496. <https://www.sciencedirect.com/science/article/pii/S138824810600467X>.

Domingo, R. (2019, May 1). Serious power shortage seen in the next few years. *Philippine Daily Inquirer*. <http://search.ebscohost.com/login.aspx?direct=true&db=n5h&AN=96XFPDI20190501.00114.2&site=ehost-live>

Li, J. (2013). An experimental study of microbial fuel cells for electricity generating: performance characterization and capacity improvement. *Journal of Sustainable Bioenergy Systems*, 3(3), 171-178.

https://www.researchgate.net/publication/276043847_An_Experimental_Study_of_Microbial_Fuel_Cells_for_Electricity_Generating_Performance_Characterization_and_Capacity_Improvement

Mano, N., Mao, F., & Heller, A. (2002). A miniature biofuel cell operating in a physiological buffer. *Journal of the American Chemical Society*, 124(44), 12962-12963. <https://pubs.acs.org/doi/10.1021/ja028514g>

Pasternak, G., Greenman, J., & Ieropoulos, I. (2016). Comprehensive study on ceramic membranes for low-cost microbial fuel cells. *Chemosuschem*, 9(1), 88-96. <https://pubmed.ncbi.nlm.nih.gov/26692569/>

Rosario. (2019). 13 M Filipinos still without electricity; party-list solons seek P28.5 to address it. *Manila Bulletin*. <https://news.mb.com.ph/2019/08/06/13-m-filipinos-still-without-electricity-partylist-solons-seek-p28-5-to-address-it/>.

Sun, H., Jianchang Li, Meihong Yang, & Qiongli Shao. (2018). Influence of Initial pH on Anodic Biofilm Formation in Single-Chambered Microbial Electrolysis Cells. *Polish Journal of Environmental Studies*, 28(3), 1377. <http://www.pjoes.com/Influence-of-Initial-pH-on-Anodic-Biofilm-nFormation-in-Single-Chambered-Microbial>,89503,0,2.html

Wen, Q., Wu, Y., Zhao, L., & Sun, Q. (2010). Production of electricity from the treatment of continuous brewery wastewater using a microbial fuel cell. *Fuel*, 89(7), 1381-1385. https://www.researchgate.net/publication/244068308_Production_of_Electricity_From_the_Treatment_of_Continuous_Brewery_Wastewater_Using_a_Microbial_Fuel_Cell

Winfield, J., Gajda, I., Greenman, J., & Ieropoulos, I. (2016). A review into the use of ceramics in microbial fuel cells. *Bioresource technology*, 215, 296-303. <https://www.sciencedirect.com/science/article/pii/S0960852416304382>

Xu, H., Qi, L., Chen, Y., Wen, Q., Wu, J., Duan, T., & Wang, Y. (2018). Preparation and microbial fuel cell application of sponge-structured hierarchical polyaniline-texture bioanode with an integration



3RD DLSU SENIOR HIGH SCHOOL RESEARCH CONGRESS

2023-2024

SUSTAINABILITY, ENVIRONMENT,
AND ENERGY

of electricity generation and energy storage.
Journal of Applied Electrochemistry, 48(11),
1285.
<https://link.springer.com/article/10.1007/s10800-018-1252-9>

Yin, Y., Huang, G., Di, M., Xue, C., Li, W., Zhang, L., & Liu, Y. (2017). Increased electroactive species concentration in anodic biofilm of *Geobacter*-inoculated microbial fuel cells under static magnetic field. *Research on Chemical Intermediates*, 43(2), 873.
https://www.researchgate.net/publication/305694977_Increased_electroactive_species_concentration_in_anodic_biofilm_of_Geobacter-inoculated_microbial_fuel_cells_under_static_magnetic_field



A Review on the Potential and Efficacy of Plant-Based Mosquito Repellents Against DEET-Based Mosquito Repellents

Andrea Ysobel T. Bacolor, Jenmond Alphine V. Guno, Dominic Kyle S. Rodriguez, Paula Justine F. Santos, and Eula Kathrina M. Tizon
De La Salle University Integrated School, Manila

Abstract: The number of insect-borne diseases has brought many health-related issues, prompting the search, discovery, and formulation of insect repellents to prevent the acquisition of diseases. However, the preferred and conventional chemical-based repellent has downsides contrary to the benefits, such as the concern towards human and environmental safety. Meanwhile, scientific understanding of plants is mainly underexplored, resulting in people's preferences for chemical-based insect repellents. The main objective of this review was to evaluate the efficacy of N, N-diethyl-3-methyl-benzamide (DEET), found in chemical-based repellents, and terpenes, found in plant essential oil-based repellents, to show the potential of both, along with the possibility of using plant-based repellents as an alternative to the conventional ones. The review was done by comparing and analyzing the fundamental data obtained from previous studies, focusing on the DEET or essential oil concentration, repellency rate, protection time for the efficacy, and the mosquito species that the tested repellents have shown to repel. After reviewing and comparing the results from primary sources, the researchers concluded that DEET-based and plant-based repellents both have potential depending on the concentration and the process of repellent formulation, as some plant-based repellents demonstrate longer protection times and thus greater potential than some of the DEET-based ones.

Key Words: DEET; terpenes; mosquito repellent; repellent-active compounds; efficacy

1. INTRODUCTION

1.1. Background of the Study

Blood-sucking and disease-carrying insects are a major cause of illness to children and adults worldwide, especially in tropical and subtropical climates (Family Doctor, 2017). This prompted the search and formulation of repellents that contain the ingredient N, N-diethyl-3-methyl-benzamide (DEET) to prevent such insect-borne diseases. While DEET repellents are proven to be the most preferred and widely used (Moore et al., 2018), there are human safety and environmental concerns along with its use. High concentrations (10% or more) being needed for the application to be effective can produce adverse effects such as dermal reactions, neurotoxic and cardiotoxic effects, seizures, or convulsions (Legeay et al., 2018). DEET has also been detected in wastewater, surface water, and groundwater (Gao et al., 2020). Moreover, studies have shown that these

conventional repellents can already be resisted by *Aedes aegypti* (Almadiy, 2020). Thus, it is significant to search for repellent alternatives that do not include hazardous chemicals and instead take on safer and natural ingredients that pose fewer risks, such as those derived from plant extracts. Although plants as repellents have potential and are already moderately used, the scientific understanding of these plants is underexplored. This review looks more into plant-based repellents, evaluates their efficacy, and compares them to those of chemical-based repellents.

1.2. Research Objectives

To be able to evaluate and compare the efficacy of chemical-based and plant-based mosquito repellents with the active compounds present, the researchers did the following: research published articles dating from 2016 to 2021; determine the properties of active compounds of both chemical-based and plant-based repellents; compare and evaluate significant similarities and

differences in the efficacy of DEET and essential oils with terpenes as mosquito repellents; and conclude the potential of plant-based repellents as an alternative to chemical-based repellents.

1.3. Scope and Limitations

The scope of this review is the evaluation of the potential of chemical repellents based on DEET and natural repellents based on plant essential oils (EOs) containing terpenes. This review covered various studies that measured the repellent activity of the said compounds against mosquito species of the order Diptera. With the reported data from previous studies, the present study is only in the form of a written review. A conclusion regarding the potential of plant-based repellents and chemical-based repellents was formulated only through the obtained information from the gathered studies.

1.4. Significance of the Study

The study serves as an exploration and evaluation of plant-based and chemical-based repellents through their efficacy. Through this, the study imparts knowledge to the general public by providing information and conclusions about the potential of the conventional chemical-based repellents and the natural repellents that are accessible and environmentally friendly. It contributes to the awareness of communities in tropical and subtropical areas regarding the advantage and usefulness of phytochemicals from plants to control insects. On a larger scale, this could contribute to the production of chemical-based and plant-based repellents, as a broader understanding of the two is essential for future innovations.

2. METHODOLOGY

2.1 Subsection

Give the support for your main claim by showing evidence for it. What are the foundations of your claim (theoretical framework)? What conclusion/s follow from it. How are you deriving the conclusion from the basis/bases of your claim (methodology)? It is not always necessary to actually state the specific logical rules for your inferences. It depends on the style that you are taking on in writing your paper. (In papers that are not highly analytical, if you find it necessary to label the actual process/es of derivation of your conclusion, do it in the footnotes.) But the correct inference must be made apparent here and you have to convince your audience of your argument.

Figures and tables should be referred to in the text. They should be centered as shown below and must be of good resolution.

2. Review of Related Literature

2.1. Active Compounds

2.1.1. Chemical-Based *N, N*-diethyl-3-methylbenzamide

Chemical compounds are often used in the formulation of commercially available repellent products. Figure 1 shows the chemical structure of one of the most widely used synthetic chemicals, *N, N*-diethyl-3-methylbenzamide, commonly known as DEET.

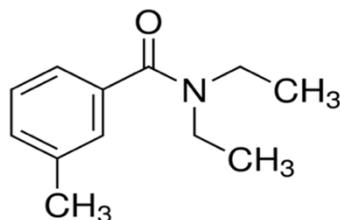
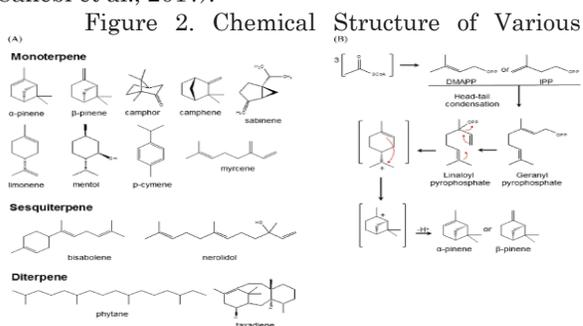

Figure 1. Chemical Structure of *N, N*-diethyl-3-methylbenzamide

DEET is known to be the 'gold standard' for repellents for its long-lasting repellency towards different species of arthropods such as mosquitoes, ticks, fleas, and flies. DEET-based repellents are available worldwide today in various formulations, including aerosols, creams, lotions, sprays, gels, sticks, and wipes (towelettes) at concentrations ranging from 5% to 100% (Riffell, 2019).

2.1.2. Plant-Based Terpenes

Among the classes of plant secondary metabolites, terpenes is the largest and most diverse group. As shown in Figure 2, terpenes are composed of branched 5-carbon isoprene units assembled in different ways and are thus classified according to the number of isoprene units they contain (Ali, 2020; Ramirez-Gomez et al., 2019). These lipid-soluble compounds are synthesized by all organisms through the mevalonate and deoxy-D-xylulose pathways (Sahebi et al., 2017).



Terpenes



Monoterpenes, which consist of two isoprene units, are important components of plant EOs. Limonene, linalool, linalyl acetate, citronellal, and carvone are some of the monoterpenes (Hussein & El-Anssary, 2018). Terpenes and terpenoids being constituents of most EOs, allow them to act as insect repellents (Ali, 2020; Valduga et al., 2019).

2.2. Study Designs and Methods

2.2.1. Gas Chromatography-Mass Spectrometry

Gas chromatography-mass spectrometry (GC-MS) is the method used to identify and quantify the active constituents in the extracted EOs from plants. The identification of the chemical components and the calculation of their corresponding percentage compositions are done as the peaks of the chromatographs are compared with the library (Arpiwi et al., 2020; Manh & Tuyet, 2020).

2.2.2. Nanoemulsion and Microencapsulation Processes for Repellent Formulations

Mohammadi et al. (2019) used the process of nanoemulsion for the formulation of some plant-based repellents. Nanoemulsion is the two-phase dispersion of two immiscible liquids, either water in oil or oil in water droplets which are stabilized by an amphiphilic surfactant (Singh et al., 2017). Moreover, Misni et al. (2016) utilized microencapsulation to formulate some repellent lotions tested against *Ae. aegypti*. Microencapsulation is a method used particularly in commercial repellent formulations, wherein the EO is encapsulated by a natural or synthetic polymeric membrane for it to control the release rate and prevent the volatile compounds from evaporating (Beestman 2003, Tuetun et al., 2008, as cited in Misni et al., 2016).

2.2.3. Repellency Test

The arm-in-cage method is a measurement test of efficacy for topical mosquito repellents under laboratory conditions. In this method, starved female mosquitoes are contained in the test cage where the skin impregnated with the repellent is exposed. The repellent is applied to the forearm area while a glove contours the unexposed part to prohibit the mosquitoes from biting there (Colucci & Müller, 2018). Mohammadi et al. (2019), Manh and Tuyet (2020), Misni et al. (2016), and Arpiwi et al. (2020) used this method based on the WHO guidelines (2009) with a few modifications to determine the efficacy of mosquito repellents.

3.1. Search Strategies and Inclusion Criteria

This review used research articles and studies written and published in various journals over the last five years, from 2016 to 2021. Most articles were researched using Google Scholar, ScienceDirect, and PubMed and were accessed using the researchers' accounts and the De La Salle University Library's online databases. To look for published works done by other researchers relevant to the scope, the search terms used were 'mosquito repellent,' 'DEET,' 'secondary metabolites,' 'terpenes,' 'chemical constituents,' and 'repellent activity.'

3.2. Screening Process

With various available publications about the repellent activities of DEET and plant EOs with terpenes, the researchers screened the date of publication and article types, not considering those published earlier than 2016 or were in the form of a review article. The titles and abstracts were then screened; articles that focused on larvicidal activity or did not test against mosquitoes were eliminated. Lastly, the full-text articles of those deemed relevant to the review were checked for eligibility; those that did not provide sufficient information about the active compounds DEET or terpenes and their protection ability against mosquitoes were excluded.

3.3. Data Analysis Strategy

With the researched related works, the researchers presented the properties of the active compounds of chemical-based and plant-based repellents. Essential data and results from the publications, such as the plant species, plant parts used, and the EO's active constituents, DEET or EO concentration in the formulated repellent, repellency rate, protection time, and mosquito species repelled by each of the formulations, were organized and summarized into a table, ordered by the chemical-based DEET, then the plant-based EOs. Analysis and evaluations on the efficacy of different repellent formulations based on protection time were then made to compare the potential of chemical-based and plant-based mosquito repellents.



3. RESULTS AND DISCUSSION

3.1. Active Compounds

Table 1. *N,N*-diethyl-3-methyl-benzamide Tested on *Aedes aegypti* and *Anopheles stephensi*

DEET Concentration in Formulated Repellent	Repellency Rate	Repellency Time	Insect Repelled	Reference
25%	100%	6.10 hours	<i>Anopheles stephensi</i>	Mohammadi et al. (2019)
20%	100%	6 hours	<i>Aedes aegypti</i>	Manh & Tuyet (2020)
20%	100%	4 hours	<i>Aedes aegypti</i>	Misni et al. (2016)
15%	100%	4 hours		
10%	100%	2 hours		
5%	100%	2 hours		

Table 2. Plant Essential Oils Tested on *Aedes aegypti* and *Anopheles stephensi*

Plant – part EO was obtained	Active Constituents in EO (GC-MS)	EO Concentration in Formulated Repellent	Repellency Rate	Repellency Time	Insect Repelled	Reference
Peppermint (<i>Mentha piperita</i>) – aerial parts	d-limonene (19.72%), thymol (19.02%), carvacrol (12.37%)	50%	100%	2.89 hours	<i>Anopheles stephensi</i>	Mohammadi et al. (2019)
		50% (Microencapsulated)	100%	4.17 hours		
Eucalyptus (<i>Eucalyptus globulus</i>) – leaves	1,8-cineole (59.45%), terpinene (10.91%)	50%	100%	0.96 hours	<i>Anopheles stephensi</i>	Mohammadi et al. (2019)
		50% (Microencapsulated)	100%	5.51 hours		
Wild mint (<i>Mentha arvensis</i>) – fresh plant leaves	menthol (66.04%), eucalyptol acetate (22.19%), menthone (2.51%), limonene (2.04%)	25%	100%	0.75 hours	<i>Aedes aegypti</i>	Manh & Tuyet (2020)
		50%	100%	1.5 hours		
		100%	100%	2.75 hours		
Chaste tree (<i>Vitex trifolia</i>) – fresh leaf samples	cis-ocimene (44.57%), α-thujene (25.63%), cyclopentene-3-isopropenyl-5,5-dimethyl (18.19%), α-pinene (6.38%)	4%	99.74%	3 hours	<i>Aedes aegypti</i>	Misni et al. (2020)
		5%	100%	3 hours		
		6%	100%	3 hours		
Lime (<i>Citrus aurantifolia</i>) – leaves	limonene, β-pinene - Al-Awadi et al. (2018) ⁷	20%	92.76%	1 hour	<i>Aedes aegypti</i>	Misni et al. (2016)
		20% (Microencapsulated)	100%	2 hours		
		15% (Microencapsulated)	100%	2 hours		
Pomelo (<i>Citrus grandis</i>) – fruit peel	limonene, β-pinene, 3-carene - Sajid et al. (2016) ⁸	20%	94.67%	1 hour	<i>Aedes aegypti</i>	Misni et al. (2016)
		20% (Microencapsulated)	100%	2 hours		
		15% (Microencapsulated)	100%	2 hours		
Galangal (<i>Alpinia galanga</i>) – rhizome	carotol, eucalyptol - Singh et al. (2020) ⁹	20%	96.89%	1 hour	<i>Aedes aegypti</i>	Misni et al. (2016)
		20% (Microencapsulated)	100%	2 hours		
		15% (Microencapsulated)	100%	2 hours		

ABC other studies that identified the active constituents present in the same EOs were used because the researchers who tested on these EO-based repellents did not perform GC-MS.

The researchers of the present study were able to compile the data from previous studies, as summarized in Tables 1 and 2, because these studies used the same bioassay method or study design wherein the formulated repellents were directly applied to the skin of the forearm of human subjects. The studies provided information about the repellency rate, repellency time, and species repelled by the formulated repellents. Moreover, the DEET or EO

concentrations listed in the tables refer to the percentage by volume composition of either DEET or a plant EO in each of the repellents formulated by the researchers.

Table 1 shows the interrelation of the repellency rate and repellency time of a formulated repellent with a particular DEET concentration tested on either *Ae. aegypti* or *An. stephensi*. Meanwhile, Table 2 shows the EOs obtained from certain parts of plants whose repellent formulations were tested on either *Ae. aegypti* or *An. stephensi*.

As can be seen in Table 1, DEET-based repellents provide long protection times, depending on the DEET concentration, against *Ae. aegypti* and *An. stephensi*, thus being widely used in conventional repellents. In contrast, Table 2 shows that all the active constituents in plant EOs identified by the researchers contained an abundance of terpenes as the major compounds, which previous studies explain to provide the potential of plant-based repellents against different mosquito species.

Several studies present the comparable potential of DEET-based and plant-based repellents in terms of protection time. The nanoemulsified eucalyptus-based repellent at 50% concentration having a complete protection time (CPT) of 5.51 hours against *An. stephensi* (Table 2) is shown to be close to the formulated 25% DEET repellent with a CPT of 6.10 hours against the same species (Table 1).

Meanwhile, the 5% and 10% concentrated DEET-based repellents, which present complete protection against *Ae. aegypti* after 2 hours (Table 1), exhibit the same repellent potential to a 15% or 20% concentration of a microencapsulated repellent based on the EO of either lime, pomelo, or galangal in terms of the time for complete protection (Table 2). There are even some plants that have demonstrated a longer CPT than the previously mentioned DEET-based repellents. As presented in Table 2, these were the 100% wild mint EO-concentrated repellent, which had a CPT of 2.75 hours, and chaste tree EO-based repellents at a concentration of either 5% or 6%, as they both demonstrated complete protection against *Ae. aegypti* up to 3 hours post-application. Given that these 5% and 6% chaste tree EO-based repellents already exhibit a high repellency rate at a longer time of protection, although formulated at a low concentration, chaste tree-based formulations with higher concentrations of EO may provide a longer CPT and exhibit a greater potential.

Furthermore, Tables 1 and 2 show that as the EO concentration in the formulated repellent is increased, the corresponding time that provided complete protection also increased. Although DEET-based repellents formulated at higher concentrations of the active compound demonstrate a longer protection time, the risks or concerns in human and



environmental safety associated with their concentrations and their use reduce their advantageous potential. In addition, as shown in Table 2, the nanoemulsion and microencapsulation processes for the formulation of plant-based repellents have significantly increased their protection time and potential, similar to DEET, compared to those that were formulated the standard way, with no additives present. The effects of these additives and methods and the concerns that may come with higher concentrations of plant EOs require further study to potentially widen the use of plant-based repellents. Such comparisons from different articles over similar variables, including DEET or EO concentration, repellency rate, or protection time, show that plant-based repellents that contain an abundance of terpenes as active constituents indeed have potential repellent properties against various mosquitoes that is comparable to that of DEET.

4. CONCLUSIONS

Comparing the various studies that presented the concentration, repellency rate, and protection time of DEET-based and plant-based repellents, it has been found that both have their potential repellent properties. Some of the repellents formulated with plant essential oils that contain terpenes, depending on the concentration, even exhibit longer protection times than DEET. This clearly shows that essential oil from plants can be utilized as an alternative to DEET-based repellents, which are known to have drawbacks, harms, and disadvantages.

Awareness regarding the potential of repellents based on various plant species that contain terpenes must thus be increased, as they can also be preferred and used as an alternative to chemical-based repellents. Moreover, further research is recommended on the repellents toward other mosquito species and insects, the plants containing other secondary metabolites as major compounds, and the repellent formulations that would improve their longevity and potentially widen their application and utilization.

5. ACKNOWLEDGMENTS

This review would not have been possible without the guidance and support of several individuals who contributed and extended their assistance to the researchers in this study. The researchers would like to express their deep and sincere gratitude to their research adviser, Dr. Mariafe Calingacion, who guided and helped them throughout the process of formulating the research topic and writing the research paper by providing the group with her knowledge and opinions.

The researchers would also like to give their utmost thanks to their previous research mentors, Dr. Archie Maglaya and Dr. Chona Camille Abeledo, who have provided the researchers with sufficient knowledge regarding the process of writing a research paper.

The researchers are very much grateful to have been given the opportunity to work under the guidance of these wonderful and knowledgeable mentors and adviser.

6. REFERENCES

- Ali, B. (2020). Salicylic acid: An efficient elicitor of secondary metabolite production in plants. *Biocatalysis and Agricultural Biotechnology*. <https://doi.org/10.1016/j.bcab.2020.101884>
- Al-Aamri, M. S., Al-Abousi, N. M., Al-Jabri, S. S., Alam, T., & Khan, S. A. (2018). Chemical composition and in-vitro antioxidant and antimicrobial activity of the essential oil of *Citrus aurantifolia* L. leaves grown in Eastern Oman. *Journal of Taibah University Medical Sciences*, 13(2), 108-112. <https://doi.org/10.1016/j.jtumed.2017.12.002>
- Almadiy, A. A. (2020). Chemical composition, insecticidal and biochemical effects of two plant oils and their major fractions against *Aedes aegypti*, the common vector of dengue fever. *Heliyon*, 6(9), e04915. <https://doi.org/10.1016/j.heliyon.2020.e04915>
- Arpiwi, N. L., Muksin, I. K., & Kriswiyanti, E. (2020). Essential oils from *Vitex trifolia* as an effective repellent for *Aedes aegypti*. *Biodiversitas*, 21(10), 4536–4544. doi: 10.13057/biodiv/d211060
- Colucci, B., & Müller, P. (2018). Evaluation of standard field and laboratory methods to compare protection times of the topical repellents PMD and DEET. *Scientific Reports*, 8(1), 1. <https://doi.org/10.1038/s41598-018-30998-2>
- Family Doctor. (2017). Insect-borne diseases. Retrieved from <https://familydoctor.org/condition/insect-borne-diseases/>
- Gao, X., Wang, X., Li, J., Ai, S., Fu, X., Fan, B., Li, W., & Liu, Z. (2020). Aquatic life criteria derivation and ecological risk assessment of DEET in China. *Ecotoxicology and Environmental Safety*, 188, 109881. <https://doi.org/10.1016/j.ecoenv.2019.109881>



- Hussein, R. A. & El-Anssary, A. A. (2018). Plants secondary metabolites: The key drivers of the pharmacological actions of medicinal plants. *Herbal Medicine. Philip F. Builders, IntechOpen*. <http://dx.doi.org/10.5772/intechopen.76139>
- Legeay, S., Clere, N., Apaire-Marchais, V., Faure, S., & Lapiéd, B. (2018). Unusual modes of action of the repellent DEET in insects highlight some human side effects. *European Journal of Pharmacology*, 825, 92–98. doi:10.1016/j.ejphar.2018.02.033
- Manh, H. D. & Tuyet, O. T. (2020). Larvicidal and repellent activity of *Mentha arvensis* L. essential oil against *Aedes aegypti*. *Insects*, 2020(11), 198.
- Misni, N., Nor, Z. M., & Ahmad, R. (2016). New candidates for plant-based repellents against *Aedes aegypti*. *Journal of the American Mosquito Control Association*, 32(2), 117-123. doi: 10.2987/moco-32-02-117-123.1
- Mohammadi, R., Khoobdel, M., Negahban, M., & Khani, S. (2019). Nanoemulsified *Mentha piperita* and *Eucalyptus globulus* oils exhibit enhanced repellent activities against *Anopheles stephensi*. *Asian Pacific Journal of Tropical Medicine*, 12(11), 520–527. doi: 10.4103/1995-7645.271292
- Moore, E. L., Scott, M. A., Rodriguez, S. D., Mitra, S., Vulcan, J., Cordova, J. J., ... Hansen, I. A. (2018). An online survey of personal mosquito-repellent strategies. *PeerJ*, 6. <https://doi.org/10.7717/peerj.5151>
- Ramirez-Gomez, X. S., Jimenez-Garcia, S. N., Campos, V. B., & Campos, M. L. G. (2019). Plant metabolites in plant defense against pathogens. *Plant Diseases – Current Threats and Management Trends*. <http://dx.doi.org/10.5772/intechopen.87958>
- Riffell, J. (2019). Olfaction: Repellents that congest the mosquito nose. *Current Biology*, 29(21), R1124-R1126. <https://doi.org/10.1016/j.cub.2019.09.053>
- Sahebi, M., Hanafi, M. M., van Wijnen, A. J., Akmar, A. S. N., Azizi, P., Idris, A. S., Taheri, S., & Foroughi, M. (2017). Profiling secondary metabolites of plant defence mechanisms and oil palm in response to *Ganoderma boninense* attack. *International Biodeterioration & Biodegradation*, 2017(122), 151-164. <http://dx.doi.org/10.1016/j.ibiod.2017.04.016>
- Sajid, A., Sarfraz, R. A., Hanif, M. A., & Shahid, M. (2016). Evaluation of chemical composition and biological activities of *Citrus pseudolimon* and *Citrus grandis* peel essential oils. *Journal of the Chemical Society of Pakistan*, 38(2), 266. <http://web.a.ebscohost.com/ehost/pdfviewer/pdfviewer?vid=2&sid=f1070230-6aa1-4453-a2dd-90230e35a4c3%40sessionmgr4008>
- Singh, Y., Meher, J. G., Raval, K., Khan, F. A., Chaurasia, M., Jain, N. K., & Chourasia, M. K. (2017). Nanoemulsion: Concepts, development and applications in drug delivery. *Journal of Controlled Release*, 252, 28–49. <https://doi.org/10.1016/j.jconrel.2017.03.008>
- Singh, S., Sahoo, B. C., Kar, S. K., Sahoo, A., Nayak, S., Kar, B., & Sahoo, S. (2020). Chemical constituents analysis of *Alpinia galanga* and *Alpinia calcarata*. *Research Journal of Pharmacology and Technology*, 13(10), 4735-4739. doi: 10.5958/0974-360X.2020.00834.3
- Valduga, A. T., Goncalves, I. L., Magri, E., & Finzer, J. R. D. (2019). Chemistry, pharmacology and new trends in traditional functional and medicinal beverages. *Food Research International*, 2019(120), 478-503. <https://doi.org/10.1016/j.foodres.2018.10.091>



Solar Power Integration in Water (H₂O) Distillation (SPIN-HD)

Charlize F. Carlos, John Raphael D. De Vera, Juan Enrico A. Nicolas,
and Steven Francis C. Ho

De La Salle University Integrated School, Manila

Abstract: As the world faces a looming crisis of water scarcity and contamination, water use and safe consumption have been compromised worldwide. People depend on tap water whose contamination causes a wide range of diseases, which are often life-threatening. Given that water purifying methods are not commonly accessible in households, and solar stills are only efficient with sunlight, this study employed a creation of a solar-powered water distiller prototype that can be used in small settings. The study consisted of designing and building a battery-powered safety testing setup, safety testing, designing and building of the solar-powered water distiller prototype, prototype testing, and data collection. An integration of hardware materials, i.e., 2 stainless steel cylindrical containers, AWG 14, car glow plug heater, customized condensation sloping lid, and 12V4.5Ah battery, was done in building the safety testing setup. The safety testing was followed by the removal of the 12V4.5Ah battery, and the consequent integration of the 50-watt solar panel, solar charge controller, and 12V30Ah battery. After five (5) experimental testings, the solar-powered water distiller prototype produced an average volume of 58.6mL in an average heating time of 112.2 minutes, making an average distillation rate of 31.3mL/hr. Such a distillation rate was obtained under an average ambient temperature of 31.2oC, average starting battery voltage of 12.3, and average end battery voltage of 4.1.

Key Words: water distillation; solar distillation; distillation

1. INTRODUCTION

Water is crucial to human survival. It eliminates body toxins, flushes waste, and regulates body temperature. It is the key to survival that humans can only last 3-4 days without it. Unfortunately, within the past hundred years, water use has been growing at a rate more than twice the human population's growth, making water insufficient to meet global demands. As water supplies continue to shrink, some parts of the world face a looming crisis (Casella, 2019). About 4 billion people, representing nearly two-thirds of the world's population, experience severe water scarcity once a month in a year (Mekonnen and Hoekstra, 2016).

Safe and readily available water is vital for public health, primarily when used for drinking and food production. However, in 2017, 2.2 billion people do not have safely managed drinking water services located on-premises, available when needed, and free from fecal and priority chemical contamination (WHO, 2019). Consequently, people have depended on tap and underground water reservoirs for their freshwater needs but these sources do not always prove to be beneficial to one's health due to the presence of excessive salinity and deficient sanitation, which widely exposes people to water-borne illnesses, such as diarrhea, cholera, and typhoid fever.

The process of water distillation requires

heat to evaporate water. The vapor, then, undergoes condensation, producing distilled water. This process removes water impurities, which can be any suspended substance, such as heavy materials, salts, and microbiological organisms (Kucera, 2005). Moreover, in distillation, solar energy can be utilized wherein the heat of the sun will heat the water, which is placed underneath a transparent cover, to evaporation. In the study conducted by Arunkumar, Vinothkumar, Ahsan, Jayaprakash, and Kumar in 2012, the most productive solar still model was the tubular solar still coupled with pyramid solar still, which has tubes and a 4-phased glass sloping top where the water vapor condensed, and accumulated. However, the downside of solar distillers like this is that although they can yield an ample amount of distilled water, they cannot function unless solar energy can be harnessed. They also depend their productivity on their size, meaning that the smaller they are, the less the volume they can subject to distillation.

As the mentioned global problem of water purifying methods not being commonly accessible in households and solar stills being inefficient in the absence of sunlight, this study aimed to integrate hardware materials to create a solar-powered water distiller, which can be used in small settings.

2. METHODOLOGY

The activities done in attaining the research objectives were composed of the designing and building of the battery-powered safety testing setup, safety testing, designing and building of the solar-powered water distiller prototype, and prototype testing and data collection. The completion of activities ranged for nine months (July 2020 to March 2021).

2.1. Materials

The materials used in building the battery-powered safety testing setup were two Phelps Dodge AWG 14 (1 meter each), stainless steel car glow plug heater, two stainless steel cylindrical containers (9in height x 8.9in diameter each), CSBattery 12V4.5Ah/20HR battery, and a customized stainless steel condensation sloping lid (See Figures 1-2).



Figure 1. Front View of the Condensation Sloping Lid



Figure 2. Bottom View of the Condensation Sloping Lid

The same wirings, heater, containers, and sloping lid were used in building the solar-powered water distiller prototype, only that a 50-watt foldable monocrystalline solar panel from Best Choice Philippines, DJ Scorpio Lead Acid 12V30Ah/20HR battery, and a PWM solar charge controller were added in the setup.

A measuring pitcher, measuring cup, Google-searched weather indicator, multimeter, and timer were used for the data collection.

2.2. Designing and Building of the Battery-powered Safety Testing Setup

In accordance with the diagram shown in Figure 3, the procedures in building the battery-powered safety testing setup involved the attachment of the car glow plug heater into the two 1-metered AWG 14, adjoining of reservoir container to the first container via condensation lid, and connection of AWG 14 to the 12V4.5Ah battery.

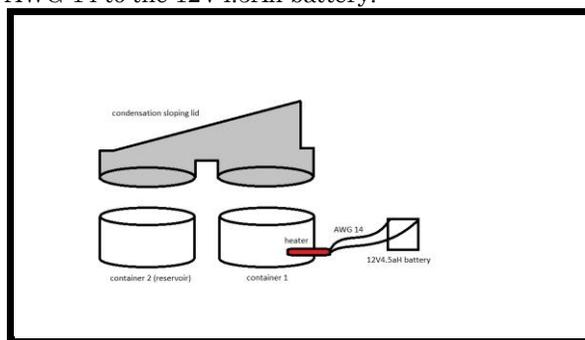

Figure 3. Battery-Powered Safety Testing Setup Diagram

2.3. Safety Testing

For this phase, 1L of water was subjected to distillation using the battery-powered safety testing setup. The safety testing determined whether the heater worked given a power source.

2.4. Designing and Building of the Solar-powered Water Distiller Prototype

The 12V4.5Ah battery was removed from the safety testing setup. It was followed by the integration of the 12V30Ah battery, 50-watt solar panel and solar charge controller, as shown in the diagram in Figure 4.

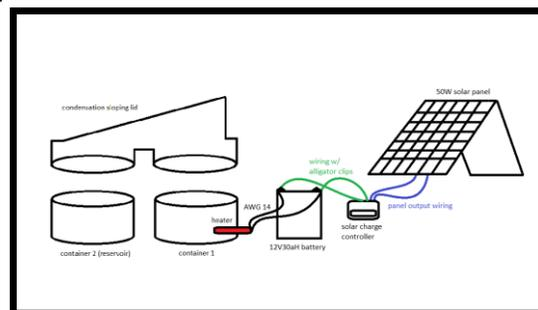

Figure 4. Final Prototype Diagram

2.5. Prototype Testing and Data Collection

The prototype was tested for five consecutive days. It was given three hours from 11AM to 2PM to perform its mechanism (Figure 5). The ambient temperature was recorded for each experiment. The solar charge controller's float charge, lead reconnect, load disconnect, programmable timer, and battery type were set as 14.5v, 11.0v, 10.7v, 24, and B1, respectively. The voltage in the battery, 5-10 seconds after the heating process started, was measured and was regarded as the starting battery voltage. The heating of the car glow plug was timed until it came to a stop. The battery's voltage was measured again and was regarded as the end battery voltage. After the system shut down, the prototype was given 40 minutes to cool down to give time for the remaining impure hot water to evaporate and condense. Finally, the volume of produced distilled water was recorded.

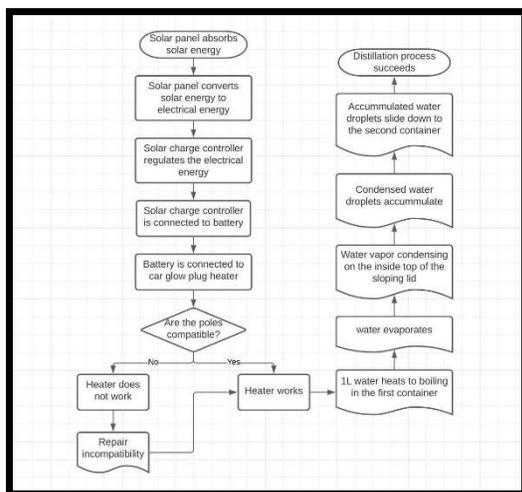

Figure 5. Prototype's Mechanism

2.6. Data Analysis

To assess whether there were significant differences in the prototype's performance, all data values from each experiment were put in a table for comparison. The mean of all data values per category was computed including the 5 distillation rates (mL/hr) that served as the prototype's average rate of distillation. The rate of distillation per experiment was determined through the formula rate of distillation= volume (mL)/hour (hr).

3. RESULTS AND DISCUSSION

3.1. Safety Testing

The safety testing setup shown in Figure 6 was built according to its design (Figure 3). The incandescence of the car glow plug heater shown in

Figure 7 proved that the positive and negative polar attachment between it and the AWG 14 (Figure 8) was compatible after being powered by the 12V4.5Ah battery.



Figure 6. Safety Testing Setup



Figure 7. Incandescence of Heater

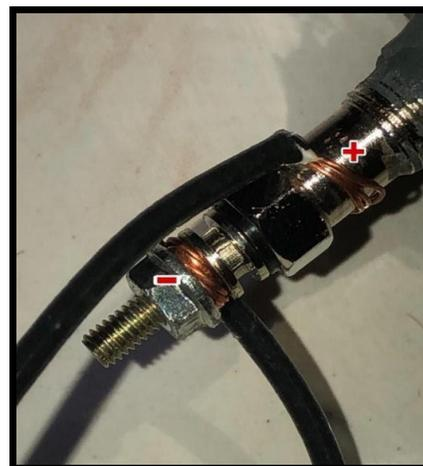

Figure 8. Heater Attached to AWG 14

As the 1L of water was heated in the first container during the safety testing, condensed water droplets formed on the cylindrical wall of the container whose surface area was not submerged (see Figure9).



Figure 9. Condensed Water Droplets on the Unsubmerged Wall of the Container

After 14 minutes, the battery was drained and the heater stopped. No distilled water was collected in the second container.

3.2. Final Prototype Testing



Figure 10. Final Prototype

After the safety testing, the building of the final prototype (Figure 10) was done according to its design shown in Figure 4.

Simultaneous prototype testing and data collection started when the heating process of the final prototype began. The heating process started when the wirings attached to the heater were pressed against their corresponding electrical poles in the

12V30Ah battery. The wirings' attachment and detachment to the battery poles served as the on and off of the prototype's heating process.

After the 12V30Ah battery's voltage dropped to an average of 4.1 (see Table 1), the heating process stopped. As the prototype cooled, a considerable amount of water droplets formed on the vertical bounds of the lid when it was detached from the containers (see Figure 11).



Figure 11. Condensed Water Droplets on the Lid's Vertical Bounds

The testing results after the 5-day trials can be seen in Table 1 below.

Table 1. Final Prototype Testing Experimental Results

Experimental trial	Ambient temperature (°C)	Starting voltage (V)	End voltage (V)	Heating time (mins)	Volume of distilled water (mL)	Rate of distillation (mL/hr)
1	32	12.4	4.1	113	59.2	31.4
2	30	12.3	4.1	109	57.6	31.7
3	31	12.5	4.1	115	59.5	31.0
4	32	12.1	4.3	108	57.4	31.9
5	31	12.1	4.1	116	59.2	30.6
Average	31.2	12.3	4.1	112.2	58.6	31.3

4. CONCLUSIONS

There was no irregularity in terms of the prototype's distillation rate obtained from each trial. The prototype was able to produce a relatively low volume of distilled water, an average of 58.6mL to be exact, in an average time of 112.2 minutes, making an average distillation rate of 31.3mL/hr. Such a rate can be obtained with specific conditions, i.e., average ambient temperature of 31.2oC, average starting battery voltage of 12.3, and average end battery voltage of 4.1.

Based on the conducted testings, it can be concluded that such a low distillation rate resulted



from four main reasons. First, the containers were too big for a 1L distillation trial. A liter of water that was poured into the first container left an ample amount of area unfilled, which concomitantly resulted to the exposure of an ample amount of unsubmerged surface area in the container. The unsubmerged surface area, then, became a vertical bound where the vapor adhered, condensed, and dropped for redistillation. Second, there was also an ample amount of vertical surface area in the condensation sloping lid where the vapor condensed. From there, the condensed droplets also cycled to drop to the first container for redistillation as the heating process continued. Third, the car glow plug heater that was inserted was too short to reach the middle of the first container. It was only able to concentrate its heat on the container's side, which made most of the vapor condense on the inside vertical bounds of the prototype. Lastly, the solar panel's wattage is too low to recharge the 12V30aH battery while the battery continued to use up its power to supply the heating process.

Although a maximum of 3.7 liters can be poured into the first container, based on the final prototype testing, the prototype's power could only make the heating process work for less than 2 hours. A load bigger than 1 liter would lengthen the time for the water to heat and evaporate, thereby draining the battery with the prototype only producing less than an average of 31.3 mL per hour or none at all.

To yield more distilled water with the same average heating time the 50-watt solar panel and 12V30Ah battery could support, there are two ways that can be considered. First, it is recommended to replace the car glow plug heater with a circular DC heater that can evenly distribute the heat among the load. However, it is crucial to take note that the heater's wattage should not exceed 50; otherwise, the battery will drain in less than the average heating time of 112.2 minutes due to the replacement's higher consumption. Second, to avoid distilled water losses, as much as possible, minimize the surface area of the sloping lid's vertical bounds by coming up with a modified lid model. Also, the use of smaller containers is recommended if only a load of 1 liter or less is preferred for the prototype. On the other hand, to distill bigger loads using the prototype with the same containers and heater, it is recommended to raise the wattage of the solar panel, as well as the battery's voltage and amp-hour rating (Ah).

5. ACKNOWLEDGMENTS

This research study made significant progress with the kind and help of many individuals. We want to extend our sincere thanks to them. Foremost, we want to offer this endeavor to our God Almighty for the wisdom he bestowed upon us, the strength, peace of mind, and good health to finish this

research. We would like to express our gratitude towards our family for their constant source of inspiration and encouragement, which helped us in the completion of this paper. Our sincerest thanks also to Mr. Luciano Catubay Jr. for assisting us all throughout the conducting of this study. We are highly indebted to De La Salle University Integrated School for the opportunity, and guidance, as well as for providing the necessary information regarding this research. We would like to express our sincerest gratitude and thanks to our Practical Research 1 and 2 professors, Dr. Archie Maglaya and Dr. Melchizedek Alipio of De La Salle University College of Engineering, for imparting their knowledge and expertise in this course. We express our special appreciation to our research adviser, Mr. Gian Carlo Lim of De La Salle University, Department of Electronics and Communications Engineering, for his constant support and supervision. Last but not least, this research paper couldn't be completed without the effort and cooperation of our group members. May we all continue to be upright in making this world a better place.

6. REFERENCES

- Ahsan, A., Arunkumar, T., Jayaprakash, R., Kumar, S., and Vinothkumar, K. (2012). Experimental Study on Various Solar Still Designs. *ISRN Renewable Energy*, 2012(18), 1-10. 10.5402/2012/569381
- Alumeco. (n.d.). Corrosion: Reasons and Solutions. <https://www.alumeco.com/knowledge-technique/general/corrosion-of-aluminium-surfaces>
- Casella, C. (2019, August 7). Nearly 25% of The World's Population Faces a Water Crisis, And We Can't Ignore It. *Science Alert*. <https://www.sciencealert.com/17-countries-are-facing-extreme-water-stress-and-they-hold-a-quarter-of-the-world-s-population>
- Castelo, J. (2020, May 20). How to Make a Solar Still: The Ultimate Purification
- Device. World Water Reserve. <https://worldwaterreserve.com/potable-water/purification/how-to-make-a-solar-still/>
- Copper Development Association Inc. (2007, April). Gauging the Difference. https://www.copper.org/consumers/copperhome/HomePlan/safety/gauging_difference.html
- H2o Labs. (n.d.) Stainless Steel Water Distiller Model 300SSE with Glass Carafe.



<http://www.h2olabs.co.uk/p-8-stainless-steel-model-300sse-water-distiller-with-glass-carafe.aspx>

Inganäs, O., & Sundström, V. (2015). Solar energy for electricity and fuels. *Ambio*, 45(2016). 15-23. <https://doi.org/10.1007/s13280-015-0729-6>

Kamrin, M., Hayden, N., Christian, B., Bennack, D., & D'Itri, F. (1991, March). Distillation for Home Water Treatment. <https://www.extension.purdue.edu/extmedia/WQ/WQ-12.html#:~:text=Distillation%20relies%20on%20evaporation%20to,condenses%20to%20form%20purified%20water.>

KaTom Restaurant Supplies (2020, April 15). Food-grade Metals. https://www.katom.com/learning-center/food-grade-metals.html?_cf_chl_captcha_tk__=65b2cad600aafa0a852bac9e58a00b0584dd1e90-1616681637-0-Ad4bdHWgXq27iTPKhoUP0RXwIK23vP63Aq8Shjb_Dg_ibR-mYRE2kq5azTNjUoZ6U172tT12v9b-JSvILf6bA0BrAfmQmvTtT6N1oflkrGvaNZqwi8JW-a_aaGAoAwTm_oU08q9_GTBk5RUxW3v7moTvQgkKvmo5Fj3IQUCF7uiEj1VvF6k7SS3s1_RxpStVcNzDp68iLDw4R4ZHKie_hyqi5rkGwOXN6C8s-nWK4L4-Q5sVOB9jUZxuv9hB8xsbcDERQfvEzLCdAKkb4etxHlpDXWuuNzm81vPP2qumqPL05r1_EacpjI3hFq_wUO7mnfEhiLSO-q_icllqEFaaHb28jJAxwNAARSH8sbFaq6v480eUN_v0UNpkpntgN0olpiGJcCj07RzboudD-5deqTn8VlgQLFJ_w81P01ajnCyufU1C5uIZ45fuingKMshz5Wu8-hSHH2hAXJu5geETC6cxfga0fBMjbOPgz5VKvvVtEJD11FX72p-KIqT7alLJLc07N2L2ZOygf8p7ZXGSHA8pPo8LZuv1BT-UGadBuHRoFRVt-8xJsTJsS1A3VXdSvK8hS12UEWcFbSghF-OcSZFyi1UYWJ-FnRbQGv5j7_5_6FzfBJmNB4aYyedO_r_Yxh1D068WcAnw7rutUsjwGM

Kucera, B. (2005, September 26). Water Distillation. Water Quality Products. <https://www.wqpmag.com/water-distillation>

Mekonnen, M. M., & Hoeksstra, A. Y. (2016). Four billion people facing severe water scarcity. *Science Advances*, 2(2). 10.1126/sciadv.1500323

Morningstar Corporation (n.d.) Why PWM? <https://www.morningstarcorp.com/wp-content/uploads/2014/02/8.-Why-PWM1.pdf>

Nicholson, J. (2018, March 13). How Does a Solenoid Work? <https://sciencing.com/a-solenoid-work-4567178.html>

Solar Power Secrets (2020, September 8). The Definitive Guide to Solar Charge Controllers: MPPT and PWM Charge Controllers in Off-Grid Solar Power Systems. <https://solarpanelsvenue.com/mppt-and-pwm-charge-controllers-in-off-grid-solar-power-systems/>

United States Environmental Protection Agency. (2016, September 29). Types of Drinking Water Contaminants. <https://www.epa.gov/ccl/types-drinking-water-contaminants>

US Food and Drug Administration. (2013). Food Code. <https://www.fda.gov/media/87140/download>

World Health Organization (2019, June 14). Drinking-water. <https://www.who.int/news-room/fact-sheets/detail/drinking-water>

World Health Organization (2019, June 14). Sanitation. <https://www.who.int/news-room/fact-sheets/detail/sanitation#:~:text=Some%20827%20000%20people%20in,killer%20but%20is%20largely%20preventable.>

Zonesun Technology Limited. (2020). ZONESUN 4L Portable Stainless steel Water Distiller Pure Water Filter, Purifier Water Distiller Filter. https://www.zonesuntech.com/products/4l-portable-stainless-steel-water-distiller-pure-water-filter-purifier-water-purifier-water-distiller-filter-treatment-container?fbclid=IwAR2tAorRWCv_yxjS6Q6rVS pKsFGY92zl1IoBwbTeVs2Jzdnja9DLPQv_Vlg



A Systematic Approach for the Paper Review on the Utilization of Citrus Fruit Waste in the Philippines

Andre L. Lu, Pierre N. Cabinbin, and Renzo B. Rivera
De La Salle University Integrated School, Manila

Arnel Beltran, *Research Adviser*
De La Salle University, Manila

Abstract: One of the main contributors to the waste problem in the Philippines is citrus fruits because of their high yield. Various studies have investigated the utilization of citrus fruit waste for different applications. However, there is a lack of a systematic mapping study that can bring these studies together. Thus, this study employed a systematic approach to determine the utilization of citrus fruit wastes which will be beneficial to reduce waste in the landfill. This study sought to: 1) investigate the trends in current research on citrus fruit waste utilization, 2) identify the processes undergone by citrus fruit waste to achieve their respective applications, and 3) observe the techniques that have been utilized to evaluate the efficiency and performance of citrus fruit waste products. The study performed a general search for papers related to citrus fruit waste utilization in Scopus search engine. The documents were organized into specific categories, and data extraction was performed. After the data was analyzed and the following results were obtained: there is a continuous increase in the amount of research on citrus fruit waste utilization, citrus fruit peels are the most commonly used type of waste, citrus fruit wastes undergo rigorous processes that mostly involve heat to reach their applications, and most studies utilize pore size and BET surface area to evaluate fruit waste products. In conclusion, citrus fruit waste utilization is a topic with great potential, and will contribute to solving the waste management problem in the country.

Key Words: citrus fruit waste; waste treatment; environment; systematic mapping study; sustainable management

1. INTRODUCTION

The Philippines is a tropical country with a high production of fruit-related products yielding high amounts of fruit waste (Zafar, 2020; PSA, 2019a, 2019b, 2019c, 2019d). In 2015, it imported over 86,967 metric tons of citrus fruits, contributing to the amount of citrus fruit waste in the country (PSA, 2015). Solid waste management is an issue in the country due to the high rates of waste generation (Atienza, 2020). Thus, the majority is placed into dumpsites or waterways, contributing to flooding and pollution (Flores et. al., 2018). Data shows that 95% of household solid waste can be reused. 43% of which can be recycled and 52% can be composted (Castillo & Otoma, 2013). This implies that there is a lack of awareness for their usefulness and has led to the belief that most solid waste is purposeless.

One topic of interest is the use of citrus fruit waste, which is rich in carbon and has been observed in wastewater treatment as an absorbent for wastewater contaminants (Pathak et.al. 2017).

Common and sustainable citrus fruit waste utilization methods such as biochar, nanocatalyst, and activated carbon were discussed in research regarding citrus fruits. Biochar is a crushed carbon material modified through physical and chemical activation processes utilizing raw waste materials such as sewage sludge. It is utilized as an adsorbent of pollutants, catalysts, and soil amendment (Cha et al., 2016). Contrarily, activated carbon (AC) has high levels of porosity, adsorptive capacity, and surface area. It is also activated using either physical or chemical processes through agricultural bio-waste materials such as palm shells. Lastly, nanocatalysts are yielded from nanomaterials and are applied in carbon nanotubes, water purification, and biodiesel production (Chaturvedi et al., 2012).

In this study, a systematic mapping approach will be utilized to gather and synthesize data (Petersen, 2015). This is employed to create an overview of a research area without progressing it. It serves only as a congregation of published knowledge



within a given limit and to identify knowledge gaps for future research. (James, 2016). As it stands, there have been numerous studies related to citrus fruit utilizations, but a lack of a systematic mapping study that can collect and bring all of these studies together.

In this paper, we will employ a systematic mapping approach for the utilization of citrus fruit wastes that can be applied in the Philippines. The objective of the study is to create a framework for the systematic mapping of the different applications of citrus fruit waste through literature search, in terms of: their utilization, processes, and performance. Recent trends and advances in the studies will also be examined. The scope of this study will be limited to citrus fruits local to the Philippines, such as calamansi, pomelo, and orange. Aside from this, the study will also be limited to sustainable biomass utilization methods, like activated carbon, biochar, and nanocatalysts. This research will be considered as a desktop study; it will focus on the data analysis of literature for results. Only research published from 2009 to 2020 in the English language found in Scopus will be included.

2. METHODOLOGY

The systematic mapping approach was used in this study to provide an overview of the different utilizations of citrus fruit waste. This study will follow a systematic approach shown in Figure 2.1 which were adapted from a study by Petersen et. al in 2008.

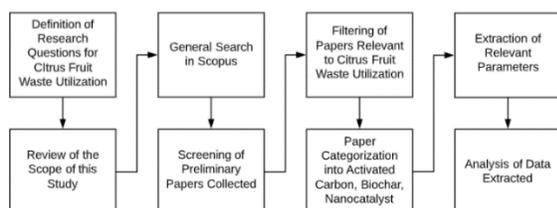

Figure 2.1 Systematic Mapping Process for Citrus Fruit Waste Utilization

2.1 Definition of Research Questions and Review of Scope

For this study, the following research questions were identified:

1. What are the trends in the current research on citrus fruit waste utilization?
2. What are the processes undergone by citrus fruit waste to achieve their respective applications?
3. What techniques have been utilized to evaluate the efficiency and performance of citrus fruit waste products?

As a review of scope, this study will focus on citrus fruits that are abundant and originate from the

Philippines and will only consider studies published in Scopus between 2009 and 2020.

2.2 General Search

In compliance with the scope mentioned for this study, a search protocol was formulated. Firstly, the search engine chosen for this study was Scopus and the primary method of search was through article title, abstract, and keywords. The search utilized Boolean operators to limit the results appropriately and only considered papers that were published between 2009-2020 and in the English language. The search string utilized for the search was: (TITLE-ABS-KEY (citrus AND (sinensis OR grandis OR microcarpa OR poonensis OR maxima OR citrofortunella)) AND TITLE-ABS-KEY (waste AND material)).

2.3 Filtering of Relevant Papers and Categorization

The papers returned by the search string were filtered by the reading of their abstract, title, and keywords. Only papers deemed relevant to the study were collected for data extraction. The papers would be categorized into activated carbon, biochar, and nanocatalyst.

2.4 Extraction of Relevant Data and Analysis

Extraction of relevant information was then performed. Specific parameters from each paper were observed and recorded for further analysis and comparison. For activated carbon, the parameters that would be observed are particle size, BET surface area, and maximum adsorption capacity. For biochar, the parameters that would be recorded are BET-N₂ specific surface area, total pore volume, and ash content. Lastly, for nanocatalysts, the parameters that would be observed are utilization and yield. Then, the recorded data would be analyzed and presented using graphs and figures.

3. RESULTS AND DISCUSSION

RQ1: What are the trends in the current research on citrus fruit waste utilization?

The search string that was previously defined returned 145 papers, 91.7% of which were published as journal articles, while the rest were presented as a conference paper or included in a book chapter. Through a search analysis within Scopus, it can be seen in Figure 3.1 that there has been a progressive increase in the amount of studies related to citrus fruit waste utilization. Of the 145 results, only 55 were found to be relevant to this study, 38% of which were related to activated carbon, 29% of which were under

biochar, and 33% were under nanocatalyst as seen in Figure 3.2.

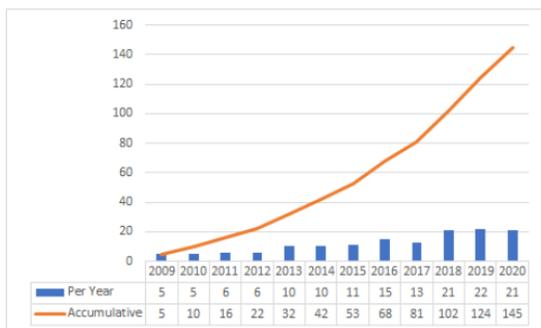

Figure 3.1 Number of papers throughout 2009-2020.

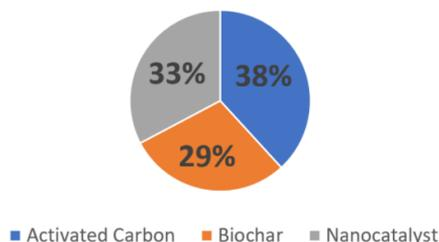

Figure 3.2 Classification of selected papers based on type of citrus fruit waste utilization.

RQ2: What are the processes undergone by citrus fruit waste to achieve their respective applications?

Biochar

The production of biochar requires the heating of a biomass with little to no oxygen. This was observed to be commonly through pyrolysis, as 13 of the 16 collected studies utilized this method. The figure below shows the process of biochar production.

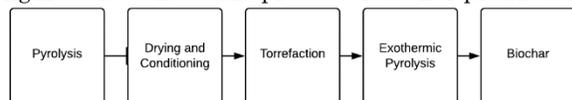

Figure 3.3 Process of Biochar Production

In pyrolysis, Drying and Conditioning occurs when biomass is dried in the temperatures between 100°C and 150°C for a moisture content of 15%. Next, Torrefaction enables the biomass to be grinded as it is heated to higher temperatures between 200°C and 280°C. Exothermic Pyrolysis then occurs when the temperature reaches 250°C to 300°C up until 400°C where the molecular bonds are broken further (Biochar for Sustainable Soils, n.d.).

Activated Carbon

Activated carbon production requires activation of a biomass. In the context of citrus fruit waste, peels are the most commonly used biomass. This is subjected through activation to produce porous

material and can occur physically or chemically. Seven (7) of the 21 researched papers utilized physical activation, while 14 utilized chemical activation. The figure below shows the process of activated carbon production.

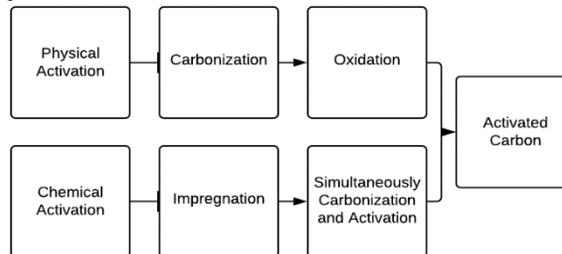

Figure 3.4 Process of Activated Carbon Production

In physical activation, the material undergoes carbonization before activation. During carbonization, the material is placed into a furnace where it is cooked at extreme temperatures ranging from 600-900°C for several hours. Certain studies have noted that higher carbonization temperatures have led to higher adsorptive capacity (Zeng et. al., 2013). Next, oxidation occurs through a process involving steam, where the carbonized material is exposed to oxidizing atmospheres in the form of steam at temperatures above 250°C.

In chemical activation, the carbon material is impregnated with certain chemicals, typically acids or strong bases. This is done by crushing and milling the material into small particles which are then mixed with the desired chemicals. Once the impregnation process is finished, the material is subjected to temperatures between 250-600°C where it is simultaneously carbonized and chemically activated. Then, the resulting carbon is washed with water to remove remaining acid and is subsequently dried.

Nanocatalysts

Nanoparticle production is mostly done through green synthesis as it is environmentally friendly and efficient. All 18 studies collected for nanocatalysts utilized green synthesis as their method of production. The figure below shows the process of nanocatalyst production.

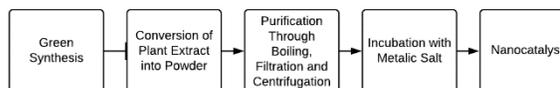

Figure 3.5 Process of Nanocatalyst Production

Green synthesis utilizes microorganisms to produce nanoparticles and is achieved through the selection of an environmentally acceptable solvent and appropriate reducing agents (Jegadeeswaran et. al., 2012). In the context of citrus fruit waste, fruit peels are regularly utilized as the reducing agents.



The process of green synthesis begins with the chosen parts of the plant, which are washed then cut into small pieces. Afterwards, the small pieces are finely grinded and boiled in water for several hours. The extract can be further purified through filtration and centrifugation. Once the extract is complete, the appropriate metallic salt is incubated with the extract in water to produce the nanoparticles of the desired metal ion.

RQ3: What techniques have been utilized to evaluate the efficiency and performance of citrus fruit waste products?

Biochar

BET-N₂ Specific Surface Area

Figure 5.3.1.1 illustrates the surface areas of the biochar wherein the largest surface area is found to be 2457.367 m²/g in Cheng et al. (2020). For the least of the biochar, it would be 0.21 m²/g in Abdelhafez (2016). It can also be observed that the majority of the results ranged from 6.7 - 53 m²/g.

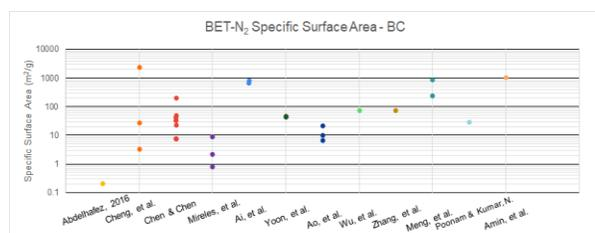

Figure 3.6 BET-N₂ Specific Surface Area

Total Pore Volume

For Figure 5.3.1.2, it illustrates the total pore volume of gathered works. The largest pore volume of 1.14 cm³/g found in Cheng et al. (2020) and the least in Abdelhafez (2016) with 0.00016 cm³/g. The majority of the results appear to lie within 0.008 - 0.035 cm³/g.

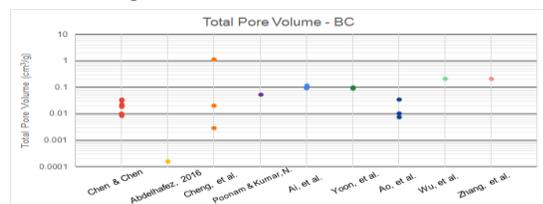

Figure 3.7 Total Pore Volume - BC

Ash Content

In Figure 3.8, the study with the highest ash content observed was 34.22% in Ai, et al. (2020). Meanwhile, the least observed was 0.30% found in Chen and Chen (2009), utilizing similar materials to Ai et al. (2020), but differing in their preparation and processes.

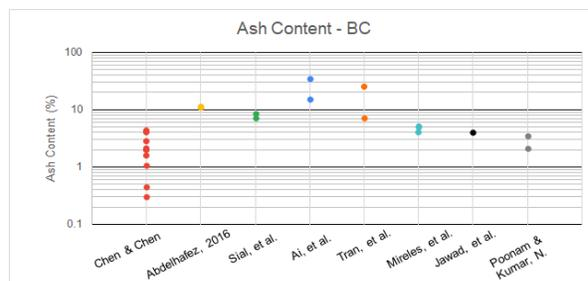

Figure 3.8 Ash Content - BC

Activated Carbon

Particle Size

In Figure 3.9, the activated carbon with the smallest particle size is ≤0.063 mm from Nemr et al. (2009) and the largest is 0.5 mm from both Fernandez, et al. (2015), and Oruc, et al. (2019).

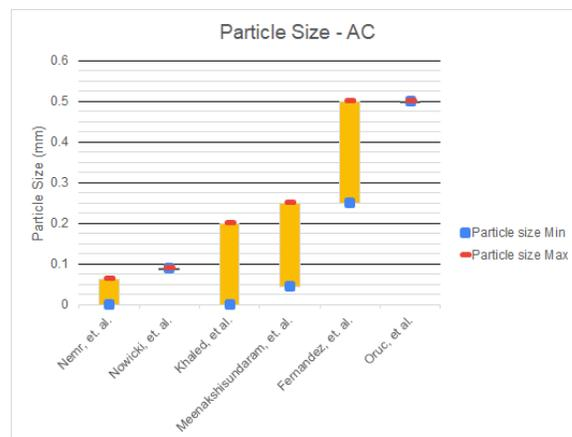

Figure 3.9 Particle Size - AC



BET Surface Area

The largest BET surface area observed was 2209.17 m²/g in Wei et al. (2019) as they chemically activated orange peels with phosphoric acid. For the smallest BET surface area, it was 2.6 in Li et al. (2016).

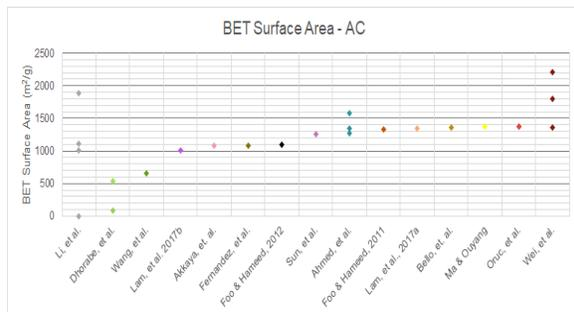

Figure 3.11 BET Surface Area - AC

Maximum Adsorption Capacity

The highest maximum adsorption capacity observed was 680 mg g⁻¹ from Li et al. (2016) wherein they tested for their chemically activated pomelo peels with potassium hydroxide, with a ratio of KOH to the pre-carbonized product for 3:1. And the lowest capacity observed was 1.210 mg g⁻¹ in Meenakshisundaram et. al. (2009) for their physically activated lemon peel.

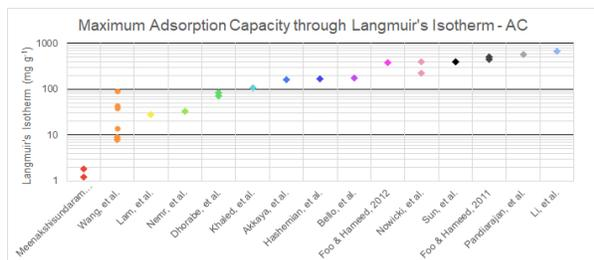

Figure 3.12 Maximum Adsorption Capacity through Langmuir's Isotherm - AC

Nanocatalysts

The smallest particle size observed is 5 nm in Dalul et al. (2020) while the largest size observed was from Ain Samat and Md Nor (2013) with 200 nm.

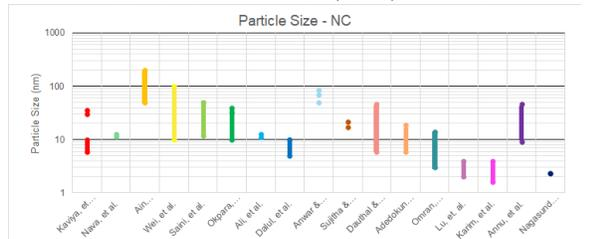

Figure 3.13 Particle Size - NC

4. CONCLUSIONS

This study has reviewed the state of the field of citrus fruit waste utilization through a systematic mapping approach. It was concluded that citrus fruit waste has a wide range of possible utilizations. This paper only focused on the applications related to waste management, thus, there is still a potential to expand the scope of this research field. Furthermore, there is an increasing trend in research related to citrus fruit waste utilization since there is a growing interest in its use due to its abundance and accessibility. Additionally, the published papers on citrus fruit waste utilization were sorted into three categories -- biochar, activated carbon, and nanocatalyst. Of the 55 papers collected, 38% were related to activated carbon, 29% were under biochar, and 33% were under nanocatalyst. Citrus fruit waste undergoes rigorous processes in order to achieve their respective applications, most of which involve subjection to high temperatures, such as pyrolysis and carbonization. Most studies evaluate citrus fruit waste products through pore size, adsorption capacity, and BET surface area.

6. REFERENCES

Abdelhafez, A.A., & Li, J. (2016). Removal of Pb(II) from aqueous solution by using biochars derived from sugar cane bagasse and orange peel. *Journal of the Taiwan Institute of Chemical Engineers*, 61, 367-375. doi: 10.1016/j.jtice.2016.01.005

Adedokun, O., Roy, A., Awodugba, A.O., & Devi, P.S. (2017). Fluorescent carbon nanoparticles from Citrus sinensis as efficient sorbents for pollutant dyes. *Luminescence*, 32(1), 62-70. doi: 10.1002/bio.3149

Ahmed, S., Rafat, M., & Ahmed, A. (2018). Nitrogen doped activated carbon derived from orange peel for supercapacitor application. *Advances in Natural Sciences: Nanoscience and Nanotechnology*, 9(3), 035008. doi: 10.1088/2043-6254/aad5d4

Ai, T., Jiang, X., Zhong, Z., Li, D., & Dai, S. (2020). Methanol-modified ultra-fine magnetic orange peel powder biochar as an effective adsorbent for removal of ibuprofen and sulfamethoxazole from water. *Adsorption Science and Technology*, 38(7-8), 304-321. doi: 10.1177/20263617420944659

Ain Samat, N., & Md Nor, R. (2013). Sol-gel synthesis of zinc oxide nanoparticles using Citrus aurantifolia extracts. *Ceramics International*, 39, S545-S548.

Akkaya Saygılı, G., Saygılı, H., Yılmaz, C., & Güzel, F. (2020). Lead recovery from aqueous environment by using porous carbon of citrus fruits waste: equilibrium, kinetics and thermodynamic studies. *Separation Science and Technology (Philadelphia)*, 55(15), 2699-2712. doi: 10.1080/01496395.2019.1653917

Amin, M.T., Alazba, A.A., & Shafiq, M. (2019). Comparative study for adsorption of methylene blue dye on biochar derived from orange peel and banana biomass in aqueous solutions. *Environmental Monitoring and Assessment*, 191(12), 735. doi: 10.1007/s10661-019-7915-0

Annu, Ahmed, S., Kaur, G., Sharma, P., Singh, S., & Ikram, S. (2018). Fruit waste (peel) as bio-reductant to synthesize silver nanoparticles with antimicrobial, antioxidant and cytotoxic activities. *Journal of Applied Biomedicine*, 16(3), 221-231. doi: 10.1016/j.jab.2018.02.002

Anwar, Y., & Alghamdi, K.M. (2020). Imparting antibacterial, antifungal and catalytic properties to cotton cloth surface via green route. *Polymer Testing*, 81, 106258. doi: 10.1016/j.polymertesting.2019.106258

Atienza, V. (2020). Waste Management in the Philippines. In Pariatamby, A., Shahul Hamid, F., & Bhatti, M. S. (Eds.), *Sustainable Waste Management Challenges in Developing Countries*, 270-286. IGI Global. doi: 10.4018/978-1-7998-0198-6.ch011

Ao, H., Cao, W., Hong, Y., Wu, J., & Wei, L. (2020). Adsorption of sulfate ion from water by zirconium oxide-modified biochar derived from pomelo peel. *Science of the Total Environment*, 708, 135092. doi: 10.1016/j.scitotenv.2019.135092

Bello, O.S., Ahmad, M.A., & Semire, B. (2015). Scavenging malachite green dye from aqueous solutions using pomelo (Citrus grandis) peels: kinetic, equilibrium and thermodynamic studies. *Desalination and Water Treatment*, 56(2), 521-535. doi: 10.1080/19443994.2014.940387

Biochar for Sustainable Soils. (n.d.). Biochar production and by-products. Biochar for Sustainable Soils. Retrieved January 4, 2021, from



- <https://biochar.international/the-biochar-opportunity/biochar-production-and-by-products/>
- Castillo, A. L., & Otoma, S. (2013). Status of Solid Waste Management in the Philippines. Retrieved January 24, from: https://www.jstage.jst.go.jp/article/jismcwm/24/0/24_677/_pdf
- Cha, J. S., Park, S. H., Jung, S. C., Ryu, C., Jeon, J. K., Shin, M. C., & Park, Y. K. (2016). Production and utilization of biochar: A review. In *Journal of Industrial and Engineering Chemistry*, 40, 1–15. Korean Society of Industrial Engineering Chemistry. doi: 10.1016/j.jiec.2016.06.002
- Chaturvedi, S., Dave, P. N., & Shah, N. K. (2012). Applications of nano-catalyst in new era. *Journal of Saudi Chemical Society*, 16(3), 307–325. doi:10.1016/j.jscs.2011.01.015
- Chen, B., & Chen, Z. (2009). Sorption of naphthalene and 1-naphthol by biochars of orange peels with different pyrolytic temperatures. *Chemosphere*, 76(1), 127–133. doi: 10.1016/j.chemosphere.2009.02.004
- Cheng, D., Ngo, H.H., Guo, W., Chang, S.W., Nguyen, D.D., Zhang, X., Varjani, S., & Liu, Y. (2020). Feasibility study on a new pomelo peel derived biochar for tetracycline antibiotics removal in swine wastewater. *Science of the Total Environment*, 720, 137662. doi: 10.1016/j.scitotenv.2020.137662
- CSI Designs (2020). WHAT IS PRESSURE DROP AND HOW DOES IT AFFECT YOUR PROCESSING SYSTEM? Retrieved March 24, from: <https://www.csidesigns.com/blog/articles/what-is-pressure-drop-and-how-does-it-affect-your-processing-system>
- Dalal, U., Gupta, V.K., Reddy, S.N., & Navani, N.K. (2020). Eradication of water borne pathogens using novel green nano Ag-biocomposite of Citrus Limetta peels. *Journal of Environmental Chemical Engineering*, 8(2), 103534. doi: 10.1016/j.jece.2019.103534
- Dauthal, P., & Mukhopadhyay, M. (2015). Agro-industrial waste-mediated synthesis and characterization of gold and silver nanoparticles and their catalytic activity for 4-nitroaniline hydrogenation. *Korean Journal of Chemical Engineering*, 32(5), 837–844. doi: 10.1007/s11814-014-0277-y
- DeSilva, F. (2000). Activated Carbon Filtration. Retrieved March 24, from: https://www.watertreatmentguide.com/activated_carbon_filtration.htm
- Dhorabe, P.T., Lataye, D.H., & Ingole, R.S. (2017). Adsorptive removal of 4-nitrophenol from aqueous solution by activated carbon prepared from waste orange peels. *Journal of Hazardous, Toxic, and Radioactive Waste*, 21(2), 04016015. doi: 10.1061/(ASCE)HZ.2153-5515.00000332
- Domingues, R. R., Trugilho, P. F., Silva, C. A., Melo, I. C. N. A. de, Melo, L. C. A., Magriotis, Z. M., & Sánchez-Monedero, M. A. (2017). Properties of biochar derived from wood and high-nutrient biomasses with the aim of agronomic and environmental benefits. *PLoS ONE*, 12(5), e0176884. doi: 10.1371/journal.pone.0176884
- Fernandez, M.E., Nunell, G.V., Bonelli, P.R., & Cukierman, A.L. (2014). Activated carbon developed from orange peels: Batch and dynamic competitive adsorption of basic dyes. *Industrial Crops and Products*, 62, 437–445. doi: 10.1016/j.indcrop.2014.09.015
- Flores, R. M., Feratero, V. J., Soneja, S. K. C., Gonzales, R. P. A. R. (2018). A Case Study about the Improper Waste Disposal in Barangay Mojon Tampoy, Philippines. Retrieved January 24 from: <https://www.researchgate.net/project/A-Case-Study-about-the-Improper-Waste-Disposal-in-Barangay-Mojon-Tampoy-Philippines>
- Foo, K.Y., & Hameed, B.H. (2011). Microwave assisted preparation of activated carbon from pomelo skin for the removal of anionic and cationic dyes. *Chemical Engineering Journal*, 173(2), 385–390. doi: 10.1016/j.cej.2011.07.073
- Foo, K. Y., & Hameed, B. H. (2012). Preparation, characterization and evaluation of adsorptive properties of orange peel based activated carbon via microwave induced K₂CO₃ activation. *Bioresource Technology*, 104, 679–686. doi: 10.1016/j.biortech.2011.10.005
- Gunamantha, I. M., & Widana, G. A. B. (2018). Characterization the potential of biochar from cow and pig manure for geocology application. *IOP Conference Series: Earth and Environmental Science*, 131(1), 12055. doi: 10.1088/1755-1315/131/1/012055
- Hashemian, S., Salari, K., & Yazdi, Z.A. (2014). Preparation of activated carbon from agricultural wastes (almond shell and orange peel) for adsorption of 2-pic from aqueous solution. *Journal of Industrial and Engineering Chemistry*, 20(4), 1892–1900. doi: 10.1016/j.jiec.2013.09.009
- James, K. L., Randall N. P., & Haddaway, N. R. (2016). A methodology for systematic mapping in environmental sciences. *Environmental Evidence*, 5, 7. doi:10.1186/s13750-016-0059-6
- Jawad, A. H., Al-Heetimi, D. T. A., & Mastuli, M. S. (2019). Biochar from orange (Citrus sinensis) peels by acid activation for methylene blue adsorption. *Iranian Journal of Chemistry and Chemical Engineering*, 38(2), 91–105.
- Jegadeeswaran, P., Shivaraj, R., & Rajendran V. (2012). Green synthesis of silver nanoparticles from extract of Padina tetrastratica leaf. *Digest Journal of Nanomaterials and Biotechnologies*, 7(3), 991–998.
- Karim, N.A., Rubinsin, N.J., Burukan, M.A.A., & Kamarudin, S.K. (2019). Sustainable route of synthesis platinum nanoparticles using orange peel extract. *International Journal of Green Energy*, 16(15), 1518–1526. doi: 10.1080/15435075.2019.1671422
- Kaviya, S., Santhanalakshmi, J., Viswanathan, B., Muthumary, J., & Srinivasan, K. (2011). Biosynthesis of silver nanoparticles using citrus sinensis peel extract and its antibacterial activity. *Spectrochimica Acta - Part A: Molecular and Biomolecular Spectroscopy*, 79(3), 594–598. doi: 10.1016/j.saa.2011.03.040
- Khaled, A., Nemr, A.E., El-Sikaily, A., & Abdelwahab, O. (2009). Removal of Direct N Blue-106 from artificial textile dye effluent using activated carbon from orange peel: Adsorption isotherm and kinetic studies. *Journal of Hazardous Materials*, 165 (1-3), 100–110. doi:10.1016/j.jhazmat.2008.09.122
- Lam, S.S., Liew, R.K., Wong, Y.M., Azwar, E., Jusoh, A., & Wahi, R. (2017). Activated Carbon for Catalyst Support from Microwave Pyrolysis of Orange Peel. *Waste and Biomass Valorization*, 8(6), 2109–2119. doi: 10.1007/s12649-016-9804-x
- Lam, S.S., Liew, R.K., Wong, Y.M., Yek, P.N.Y., Ma, N.L., Lee, C.L., & Chase, H.A. (2017). Microwave-assisted pyrolysis with chemical activation, an innovative method to convert orange peel into activated carbon with improved properties as dye adsorbent. *Journal of Cleaner Production*, 162, 1376–1387. doi: 10.1016/j.jclepro.2017.06.131
- Li, H., Sun, Z., Zhang, L., Tian, Y., Cui, G., & Yan, S. (2016). A cost-effective porous carbon derived from pomelo peel for the removal of methyl orange from aqueous solution. *Colloids and Surfaces A: Physicochemical and Engineering Aspects*, 489, 191–199. doi: 10.1016/j.colsurfa.2015.10.041
- Ma, X., & Ouyang, F. (2013). Adsorption properties of pomelo skin by phosphoric acid activation. *Applied Surface Science*, 268, 566–570. doi: 10.1016/j.apsusc.2013.01.009
- Makarov, V. V., Love, A. J., Sinitsyna, O. V., Makarova, S. S., Yaminsky, I. V., Talianky, M. E., & Kalinina, N. O., (2014). "Green" nanotechnologies: synthesis of metal nanoparticles using plants. *Acta Naturae*, 6(1), 35–44.
- Meenakshisundaram, M., Kannan, N., & Rejinis, J. (2009). Removal of azure A from aqueous solution by CAC and new activated carbon from orange peel and lemon peel. *Electronic Journal of Environmental, Agricultural and Food Chemistry*, 8(8), 574–583.
- Meng, H., Nie, C., Li, W., Duan, X., Lai, B., Ao, Z., Wang, S., & An, T. (2020). Insight into the effect of lignocellulosic biomass source on the performance of biochar as persulfate activator for aqueous organic pollutants remediation: Epicarp and mesocarp of citrus peels as examples. *Journal of Hazardous Materials*, 399. doi: 10.1016/j.jhazmat.2020.123043
- Mireles, S., Parsons, J., Trad, T., Cheng, C. L., & Kang, J. (2019). Lead removal from aqueous solutions using biochars derived from corn stover, orange peel, and pistachio shell. *International Journal of Environmental Science and Technology*, 16(10), 5817–5826. doi: 10.1007/s13762-018-02191-5
- Nagasundaram, N., Kokila, M., Sivaguru, P., Santhosh, R., & Lalitha, A. (2020). SO₃H@carbon powder derived from waste orange peel: An efficient, nano-sized greener catalyst for the synthesis of dihydropyranol[2,3-c]pyrazole derivatives. *Advanced Powder Technology*, 31(4), 1516–1528. doi: 10.1016/j.apt.2020.01.012
- Nava, O.J., Soto-Robles, C.A., Gómez-Gutiérrez, C.M., Vilchis-Nestor, A.R., Castro-Beltrán, A., Olivas, A., & Luque, P.A. (2017). Fruit peel extract mediated green synthesis of zinc oxide nanoparticles. *Journal of Molecular Structure*, 1147, 1–6. doi: 10.1016/j.molstruc.2017.06.078
- Nemr, A.E., Abdelwahab, O., El-Sikaily, A., & Khaled, A. (2009). Removal of direct blue-86 from aqueous solution by new activated carbon developed from orange peel. *Journal of Hazardous Materials*, 165 (1), 102–110. doi: 10.1016/j.jhazmat.2008.03.060
- Nowicki, P., Kazmierczak-Razna, J., & Pietrzak, R. (2016). Physicochemical and adsorption properties of carbonaceous sorbents prepared by activation of tropical fruit skins with potassium carbonate. *Materials and Design*, 90, 579–585. doi: 10.1016/j.matdes.2015.11.004
- Okpara, E.C., Fayemi, O.E., Sherif, E.M., Junaedi, H., & Ebenso, E.E. (2020). Green wastes mediated zinc oxide nanoparticles: Synthesis, characterization and electrochemical studies. *Materials*, 13(19), 4241.
- Omran, B.A., Nassar, H.N., Fatthallah, N.A., Hamdy, A., El-Shatoury, E.H., & El-Gendy, N.S. (2018). Waste upcycling of Citrus sinensis peels as a green route for the synthesis of silver nanoparticles. *Energy Sources, Part A: Recovery, Utilization and Environmental Effects*, 40(2), 227–236. doi: 10.1080/15567036.2017.1410597
- Oruç, Z., Ergüt, M., Uzunoğlu, D., & Özer, A. (2019). Green synthesis of biomass-derived activated carbon/Fe-Zn bimetallic nanoparticles from lemon (Citrus limon (L.) Burm. f.) wastes for heterogeneous Fenton-like decolorization of Reactive Red 2. *Journal of Environmental Chemical Engineering*, 7(4), 103231. doi: 10.1016/j.jece.2019.103231
- Pandiarajan, A., Kamaraj, R., Vasudevan, S., & Vasudevan, S. (2018). OPAC (orange peel activated carbon) derived from waste orange peel for the adsorption of chlorophenoxyacetic acid herbicides from water: Adsorption isotherm, kinetic modelling and thermodynamic studies. *Bioresource Technology*, 261, 329–341. doi: 10.1016/j.biortech.2018.04.005
- Pathak, P. D., Mandavgane, S. A., & Kulkarni, B. D. (2017). Fruit peel waste: Characterization and its potential uses. *Current Science*, 113(3), 444–454. doi: 10.18520/cs/v113/03/444-454
- Petersen, K., Feldt, R., Mujtaba, S., Mattsson, M. (2008). Systematic Mapping Studies in Software Engineering. In: *Proceedings of the 12th international conference on evaluation and assessment in software engineering*. BCS Learning & Development Ltd., Swindon, pp 68 - 77
- Petersen, K., Vakkalanka, S., & Kuzniarz, L. (2015). Guidelines for conducting systematic mapping studies in software engineering: An update. *Information and Software Technology*, 64, 1–18. doi: 10.1016/j.infsof.2015.03.007
- <https://www.sciencedirect.com/science/article/pii/S0950584915000646?via%3Dihub>



- Poonam, & Kumar, N. (2020). Experimental and kinetic study of removal of lead (Pb+2) from battery effluent using sweet lemon (Citrus limetta) peal biochar adsorbent. *Environment, Development and Sustainability*, 22(5), 4379–4406. doi: 10.1007/s10668-019-00389-2
- PSA. (2015). Foreign Trade Statistics of the Philippines. PSA. Retrieved from http://www.psa.gov.ph/sites/default/files/Volume%201%20-%20IMPORTS_FTS%202015%20e-Book_as%20of%2003-18-17.pdf
- PSA. (2019a). Major Fruit Crops Quarterly Bulletin: January - March 2019. PSA. Retrieved April 16, 2020, from https://psa.gov.ph/sites/default/files/Major%20Fruit%20Crops%20Quarterly%20Bulletin%2C%20January-March_1.pdf
- PSA. (2019b). Major Fruit Crops Quarterly Bulletin: April - June 2019. PSA. Retrieved April 16, 2020, from https://psa.gov.ph/sites/default/files/Major%20Fruitcrops%20Quarterly%20Bulletin%2C%20April%20-%20June%202019_0.pdf
- PSA. (2019c). Major Fruit Crops Quarterly Bulletin: July - September 2019. PSA. Retrieved April 16, 2020, from https://psa.gov.ph/sites/default/files/Major%20Fruitcrops%20Quarterly%20Bulletin%2C%20July%20-%20September%202019_2.pdf
- PSA. (2019d). Major Fruit Crops Quarterly Bulletin: October - December 2019. PSA. Retrieved April 16, 2020, from https://psa.gov.ph/sites/default/files/Major%20Fruitcrops%20Quarterly%20Bulletin%2C%20October-December%202019_1.pdf
- Sahetya, T. J., Dixit, F., & Balasubramanian, K. (2015). Waste citrus fruit peels for removal of Hg(II) ions. *Desalination and Water Treatment*, 53(5), 1404–1416. doi:10.1080/19443994.2013.852483
- Saini, J., Garg, V.K., & Gupta, R.K. (2020). Green synthesized SiO₂@OPW nanocomposites for enhanced Lead (II) removal from water. *Arabian Journal of Chemistry*, 13(1), 2496-2507. doi: 10.1016/j.arabjc.2018.06.003
- Siddiqui, N., Masum, A.A., Uddin, M.R., Mandal, S., Sengupta, M., Islam, M.M., & Mukhopadhyay, S. (2019). Elucidating the chemical and biochemical applications of Citrus sinensis-mediated silver nanocrystal. *Journal of Biomolecular Structure and Dynamics*, 37(18), 4863-4874. doi: 10.1080/07391102.2018.1559763
- Sujitha, M.V., & Kannan, S. (2013). Green synthesis of gold nanoparticles using Citrus fruits (Citrus limon, Citrus reticulata and Citrus sinensis) aqueous extract and its characterization. *Spectrochimica Acta - Part A: Molecular and Biomolecular Spectroscopy*, 102, 15-23. doi: 10.1016/j.saa.2012.09.042
- Sun, Y., Li, H., Li, G., Zhou, W., Yue, Q. & Li, X. (2016). Characterization and ciprofloxacin adsorption properties of activated carbons prepared from biomass wastes by H₃PO₄ activation. *Bioresource Technology*, 217, 239-244. doi: 10.1016/j.biortech.2016.03.047
- Tran, H. N., You, S. J., & Chao, H. P. (2016). Effect of pyrolysis temperatures and times on the adsorption of cadmium onto orange peel derived biochar. *Waste Management and Research*, 34(2), 129–138. doi:10.1177/0734242X15615698
- Wang, Y., Wang, S.-L., Xie, T., & Cao, J. (2020). Activated carbon derived from waste tangerine seed for the high-performance adsorption of carbamate pesticides from water and plant. *Bioresource Technology*, 316, 123929. doi: 10.1016/j.biortech.2020.123929
- Wei, Q., Chen, Z., Cheng, Y., Wang, X., Yang, X., & Wang, Z. (2019). Preparation and electrochemical performance of orange peel based-activated carbons activated by different activators. *Colloids and Surfaces A: Physicochemical and Engineering Aspects*, 574, 221-227. doi: 10.1016/j.colsurfa.2019.04.065
- Wei, Y., Fang, Z., Zheng, L., Tan, L., & Tsang, E.P. (2016). Green synthesis of Fe nanoparticles using Citrus maxima peels aqueous extracts. *Materials Letters*, 185, 384-386. doi: 10.1016/j.matlet.2016.09.029
- Wu, Y., Cha, L., Fan, Y., Fang, P., Ming, Z., & Sha, H. (2017). Activated Biochar Prepared by Pomelo Peel Using H₃PO₄ for the Adsorption of Hexavalent Chromium: Performance and Mechanism. *Water, Air, and Soil Pollution*, 228(10). doi:10.1007/s11270-017-3587-y
- Yoon, K., Cho, D. W., Bhatnagar, A., & Song, H. (2020). Adsorption of As(V) and Ni(II) by Fe-Biochar composite fabricated by co-pyrolysis of orange peel and red mud. *Environmental Research*, 188. doi:10.1016/j.envres.2020.109809
- Zafar, S. (2020, July 23). Agricultural Wastes in the Philippines. Retrieved January 24, from: <https://www.bioenergyconsult.com/agricultural-resources-in-philippines/>
- Zeng, R., Tang, W., Feng, Y., Liu, M., Huang, B., & Wu, A. (2013). Adsorption of bisphenol-A by using carbonized pomelo peel. *Chinese Journal of Environmental Engineering*, 7(10), 3797-3801.
- Zhang, B., Wu, Y., & Cha, L. (2020). Removal of methyl orange dye using activated biochar derived from pomelo peel wastes: performance, isotherm, and kinetic studies. *Journal of Dispersion Science and Technology*, 41(1), 125–136. doi: 10.1080/01932691.2018.1561298
- Zhao, T., Yao, Y., Li, D., Wu, F., Zhang, C., & Gao, B. (2018). Facile low-temperature one-step synthesis of pomelo peel biochar under air atmosphere and its adsorption behaviors for Ag(I) and Pb(II). *Science of the Total Environment*, 640–641, 73–79. doi:10.1016/j.scitotenv.2018.05.251



Effervescent Water Coagulant from *Citrofortunella Microcarpa* Scraps for Water Treatment

Alyanna Hazel Y. Cabrera, Annika Jeuel Q. Duyan, Christiana Marie P. Pinpin,
and Kyrille Justine T. Ang

De La Salle University Integrated School, Manila

Abstract: As the Philippines experiences increasing alerts in water pollution, this study aims to create a Calamansi-based effervescent water coagulant to increase the accessibility of purified water to Filipinos. The study makes use of *Citrofortunella microcarpa* (Calamansi), a small citrus fruit abundant in the Philippines. Calamansi has a big contribution in the production of agricultural waste as the fruit is mainly utilized for its pulp; therefore, the researchers focused on the usage of Calamansi's peels and seeds, given their ability to absorb minute particles and to kill bacteria. Disposed Calamansi scraps were powderized and mixed with other components to form an eco-friendly effervescent water coagulant. The researchers assessed the efficacy of the Calamansi coagulant by comparing it to Ferric chloride (FeCl_3), an existing chemical water coagulant, and testing ten trials of each sample in a contaminated soil-water mixture. The group's findings suggest that the effervescent Calamansi coagulant presented a higher efficacy in water treatment than FeCl_3 , with its pH, electrical conductivity (EC), total dissolved solids (TDS), and salinity readings all within the standard range. The Calamansi coagulant accumulated more residue than the FeCl_3 sample. The study demonstrates that Calamansi seed and peel waste offer a great alternative to chemical-based coagulants in water treatment.

Key Words: water treatment; bath bomb; calamansi; coagulation; adsorption

1. INTRODUCTION

The Philippines is surrounded by numerous bodies of water; however, water shortage has been a prominent issue in the country due to pollution, climate change, and the El Niño phenomenon (World Health Organization, 2019). This water crisis forces Filipinos to consume contaminated water at higher rates, with almost seven million drinking from unsafe water and 24 million having no access to improved sanitation (water.org, n.d.). Further, the severity of water pollution in the Philippines contributes to the rapid increase of agricultural waste.

Citrofortunella microcarpa, commonly known as Calamansi, is a small citrus fruit predominantly cultivated in the Philippines and used as a condiment in Filipino cuisine. Calamansi is one of the main contributors to Philippine agricultural waste, as consumers focus on the fruit's affordability and versatility rather than the adsorbent quality of its scraps. Adsorption is a vital process in water treatment which adheres layers of molecules to the surface of a liquid or solid in contact ("What is adsorption?", 2016).

To address the influx of water contamination and agricultural wastes in the Philippines, the group aims to design an eco-friendly, portable, and accessible Calamansi-based water coagulant with a

bath bomb's effervescent formula. Coagulation is a common water treatment technique, involving the adsorption of large amounts of organic compounds and suspended particles (Safe Drinking Water Foundation, n.d.). This coagulant intends to purify polluted water along the marginalized communities in Manila (near polluted riverbanks) and allow them access to clean water supply.

In this study, the group was able to further comprehend water purification through the process of coagulation. The researchers collected Calamansi scraps and created an effervescent Calamansi coagulant as a cheaper substitute for other coagulants in the market. Moreover, they were able to determine the amount of Calamansi peels needed to create an impurity coagulant in the form of a bath bomb, to which they compared Ferric chloride (FeCl_3), an existing chemical-based water coagulant, by testing the efficacy of both coagulants in contaminated water. Four tests namely, pH, electrical conductivity (EC), total dissolved solids (TDS), and salinity, were conducted to determine the quality of the water tested. The researchers used comparative analysis, correlation analysis, and regression analysis to analyze the retrieved data.

The study includes several limitations in accordance with the quarantine protocols. The final



product is not applicable for large bodies of water and is only tested on controlled basins. With this, the final product is only currently capable of coagulation, as further directives must be approached to achieve total purification.

2. METHODOLOGY

2.1. Literature review

The researchers reviewed past studies and approaches as experimental guides. The group examined a similar study conducted by Dollah et al. (2019) involving the investigation of *Citrus aurantiifolia* (key lime) and *Citrus microcarpa* (kasturi lime) waste as natural coagulants for water treatment, and modified the previous study's setup by incorporating bath bomb technology. Data gathered were corroborated through experimental trials; after which, the group integrated the coagulation process in water treatment.

2.2. Calamansi scraps collection

Disposed Calamansi scraps were gathered and accumulated for two weeks. After two weeks, the Calamansi peels and seeds were sun-dried for one week to eliminate the moisture content. Once the peels turned brittle and observed a light brown color and the seeds hardened with no apparent color change, the scraps were then ground using a mortar and pestle until a powdery finish was achieved.

2.3. Coagulant formulation

The powdered Calamansi scraps were transferred to another container with baking soda and citric acid, following the 2:1 ratio, and were mixed before transferring into the mold which is 4 cm in diameter. The mixture sat in the mold for 15 hours until the coagulant hardened. This procedure was then repeated 9 more times to create ten coagulants with varied compositions (Table 1).

Table 1. Amount of Calamansi scraps, citric acid, and baking soda added per trial

Trial	Calamansi Scraps (g)	Citric Acid (g)	Baking Soda (g)
1	0.5	14.8	29.7
2	1.0	14.7	29.3
3	1.5	14.5	29.0
4	2.0	14.3	28.7
5	2.5	14.2	28.3
6	3.0	14.0	28.0
7	3.5	13.8	27.7
8	4.0	13.7	27.3
9	4.5	13.5	27.0
10	5.0	13.3	26.7

2.4. Experimentation

The researchers assessed the efficacy of the coagulants by comparing the Calamansi and the Ferric chloride (FeCl₃) samples. For the first experimental setup, the coagulants were tested in

contaminated water. Quarantine protocols have restricted the researchers from collecting contaminated water from rivers; therefore, a soil-water mixture, composed of 1 L of tap water and 50 g of soil, was used as a substitute. Electrical conductivity (EC), pH, total dissolved solids (TDS), and salinity tests were first conducted on the soil-water mixture before starting the overall experiment. Then, the Calamansi coagulants were dropped into the soil-water mixture and were left untouched for one hour to allow the residues to settle. The water was then filtered, and the residue was separated from the water. The residues were then sun dried to eliminate the moisture content present in them and were weighed afterward. The four water tests were then again conducted to the water. The same procedure was applied to the second experimental setup. The only difference was that Ferric chloride (FeCl₃) was used instead of the Calamansi coagulant (Table 2).

Table 2. Amount of Ferric chloride (FeCl₃) per trial

Trial	Ferric chloride (g)
1	0.5
2	1.0
3	1.5
4	2.0
5	2.5
6	3.0
7	3.5
8	4.0
9	4.5
10	5.0

2.5. Data Analysis

For a successful trial, the result of the readings should be within standard ranges (Table 3). The results were analyzed via correlation and regression to determine and predict the relationship between the amount of fruit peels and the rate of absorption. Furthermore, a comparative analysis was applied to compare the Calamansi coagulant and the Ferric chloride (FeCl₃) samples.

Table 3. Ranges to be considered

Water Quality Tester	Range of Required Reading
Water pH Tester	6.5 pH – 8.5 pH 7 pH at 25°C
Electrical Conductivity Test	200 to 800 µS/cm
Total Dissolved Solids Test	50 – 250 ppm
Salinity Test	Less than or equal to 500 ppm

3. RESULTS AND DISCUSSION

3.1. Comparative Analysis

Based on the ranges of required reading, the Calamansi coagulants were more successful than the Ferric chloride (FeCl₃) in impurity removal. Since none of the temperatures were at 25°C, the researchers disregarded this criterion (Table 4 & Table 5).

For the pH levels, the group opted to target the value range of 6.5 and 8.5. Only the Calamansi coagulant



with 0.5 g scraps is an outlier, having a pH of 6.4. Otherwise, all of them exceeded 6.5. On the other hand, the Ferric chloride trials were all acidic, ranging from 2.4 to 3.15 (Table 4 & Table 5).

The Calamansi coagulant trials also concurred the needed criteria in the electrical conductivity test. All Calamansi coagulant trials exceeded 200 $\mu\text{S}/\text{cm}$, having 210 $\mu\text{S}/\text{cm}$ and 238 $\mu\text{S}/\text{cm}$ as the highest and lowest values respectively. All Ferric chloride (FeCl_3) trials surpassed the highest standard value of 800 $\mu\text{S}/\text{cm}$; only Trial 1 had the lowest value of 634 $\mu\text{S}/\text{cm}$ (Table 4 & Table 5).

Prior to the experimentation, the TDS test for both the Ferric chloride (FeCl_3) and Calamansi coagulant have already reached the target ppm, obtaining levels ranging from 82-124 ppm. The results showed little to no change after the Calamansi coagulant trials were conducted, but have grown significantly with the use of Ferric chloride (FeCl_3), with values increasing to 317-2040 ppm. All but Trials 1 and 2 greatly exceeded the targeted values (Table 4 & Table 5).

Salinity levels of the Ferric chloride (FeCl_3) and Calamansi coagulant before the experiment exhibit the same values as the TDS test, obtaining a target level of less than 500 ppm. For the Calamansi coagulant trials, their salinity levels increased to 121-135 ppm, except for Trial 2 whose salinity decreased to 107. All levels were within the acceptable range. On the other hand, Ferric chloride (FeCl_3) trials spiked identically to their TDS results, far surpassing the targeted value, except for Trials 1 and 2 whose values were still within range (Table 4 & Table 5).

While there was no standard for the amount of residue removed, the Calamansi coagulant was shown to have removed greater amounts of residue, with a minimum of 0.65 g removed to a maximum of 4.58 g. The Ferric chloride (FeCl_3) managed to remove, at the least, only 0.03 g and at the most, 1.43 g (Table 4 & Table 5).

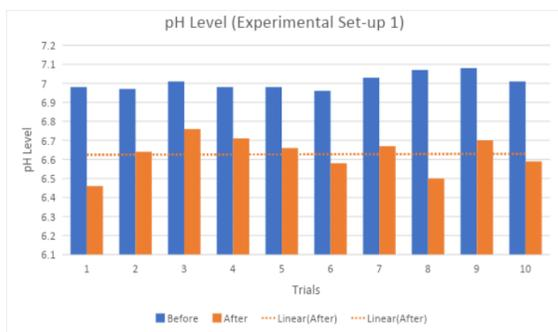

Figure 1. pH Level (Experimental Set-up 1)

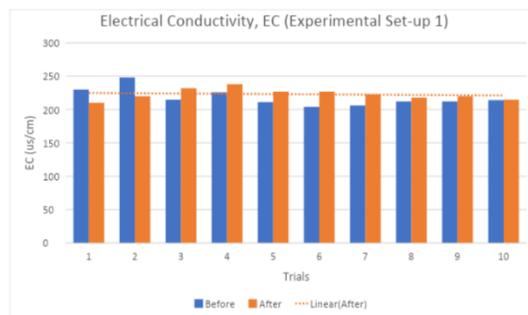

Figure 2. Electrical Conductivity (Experimental Set-up 1)

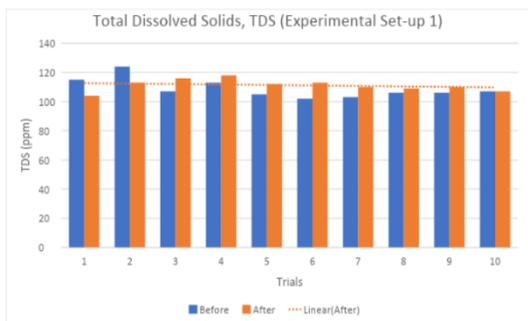

Figure 3. Total Dissolved Solids (experimental Set-up 1)

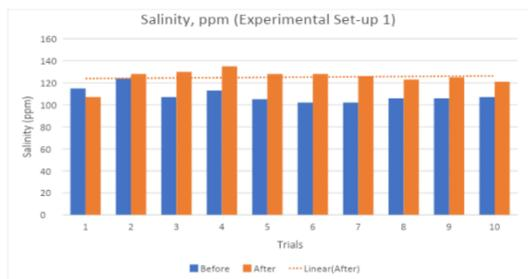

Figure 4. Salinity (Experimental Set-up 1)

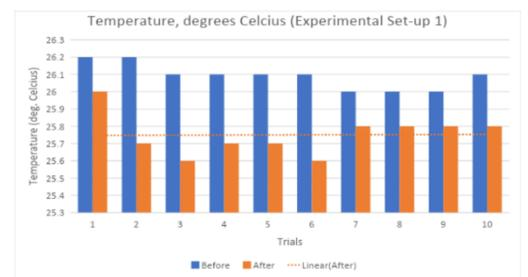

Figure 5. Temperature (Experimental Set-up 1)

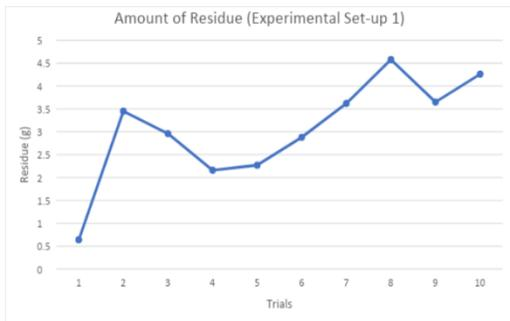

Figure 6. Amount of Residue (Experimental Set-up 1)

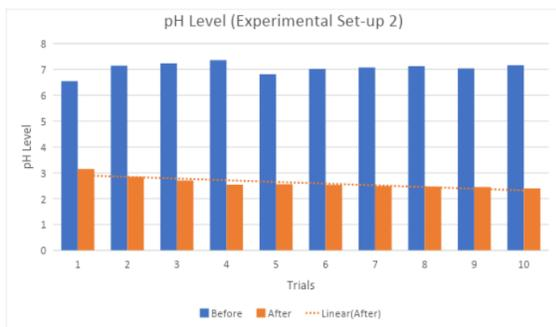

Figure 7. pH Level (Experimental Set-up 2)

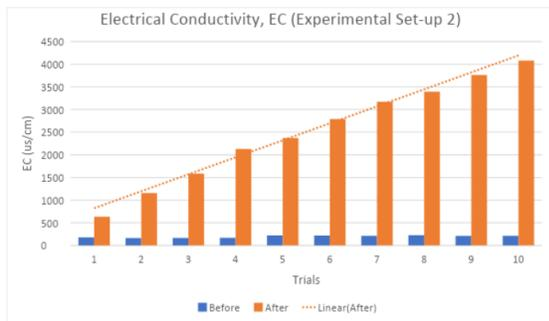

Figure 8. Electrical Conductivity (Experimental Set-up 2)

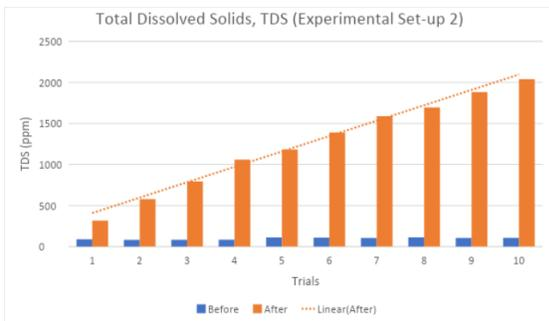

Figure 9. Total Dissolved Solids (Experimental Set-up 2)

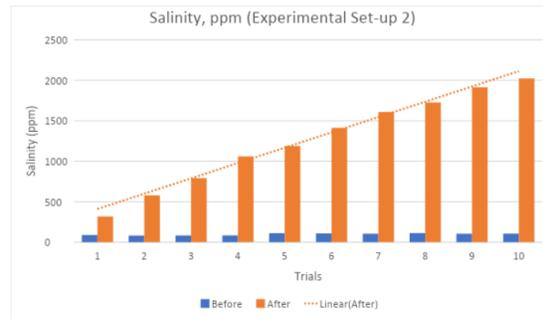

Figure 10. Salinity (Experimental Set-up 2)

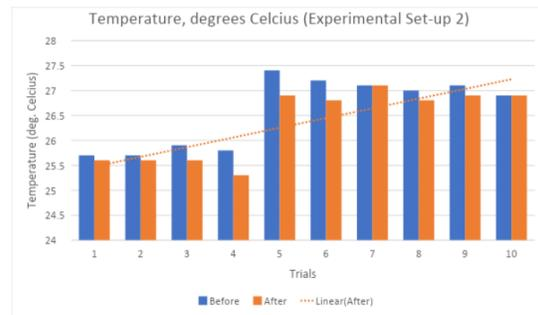

Figure 11. Temperature (Experimental Set-up 2)

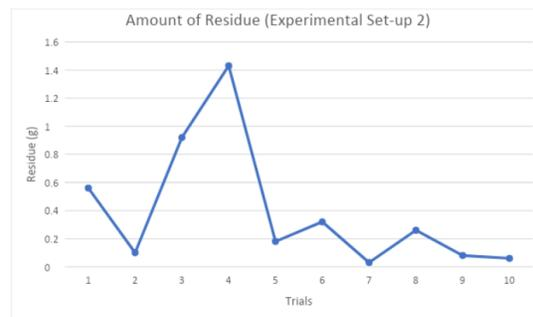

Figure 12. Amount of Residue (Experimental Set-up 2)

3.2. Correlation and Regression Analysis

The grams of Calamansi peels have weak correlations with the pH levels, electrical conductivity, total dissolved solids, and salinity. Each of these correlations garnered coefficients of 0.017, -0.16, -0.23, and 0.11, respectively. Since these values are closer to 0 than 1, they have small correlations with the grams of Calamansi peels used. In line with this, the regression coefficients are very low. They garnered values of 0, 0.24, 0.053, and 0.011, respectively.

The relationship between the grams of residue and the grams of Calamansi peels has a high degree of positive correlation, having a coefficient of 0.75. However, the regression coefficient is weak, having a value of 0.56.

On the other hand, the correlation between the grams of Ferric chloride (FeCl₃) and the pH levels is a strong negative one, garnering a value of -0.87. The regression coefficient garnered is 0.75.



The relationships of the grams of Ferric chloride (FeCl_3) with electrical conductivity, total dissolved solids, and salinity are strong positive correlations. The correlation coefficients and regression coefficients of these three relationships are 0.99.

A moderate correlation is formed between the grams of residue accumulated and the grams of Ferric chloride (FeCl_3) used. The correlation coefficient of this relationship is -0.48, while the regression coefficient is 0.23.

Discussion

The formulation of the Calamansi coagulant with the highest efficacy utilized 4.0 g of powdered Calamansi waste which, when mass produced, can greatly benefit our environmental impact. Its compact size of 4 cm in diameter and weight of approximately 45 g makes it easy to bring anywhere. Since Calamansi fruit is an important fruit crop in the Philippines, having produced 14.86 thousand metric tons in the first quarter of 2019 (Araneta, 2020), it can be easily grown and utilized for various purposes.

Comparing both results with the standard range for purified water, the Calamansi coagulant formulated was shown to be more effective. The amount of residue accumulated by the Calamansi coagulants were also greater than the Ferric chloride (FeCl_3) coagulants. Its pH levels, EC, TDS, and salinity showed little to no changes after experimentation and were all within the standard. Each of their correlations with the Calamansi garnered coefficients close to 0, resulting in a weak correlation and regression. It, however, showed strong positive correlation and moderate to high regression with the amount of residue. Meanwhile, the results of the Ferric chloride (FeCl_3) were either too low or too high for the standard. Each of the readings showed strong positive correlations with Ferric chloride (FeCl_3), except for the pH levels which showed strong negative correlation, however, its correlation with the amount of residue was only moderate.

4. CONCLUSIONS

The efficacy of the Calamansi coagulants formulated by the researchers as coagulants for water treatment were investigated and compared with Ferric chloride (FeCl_3), an existing chemical water purifier. The coagulant was composed of crushed and powdered seeds and peels of Calamansi mixed with baking soda and citric acid. Ten trials each were conducted for the coagulant and Ferric chloride (FeCl_3).

The researchers were able to successfully conduct the experiment. Results showed that the Calamansi coagulant was able to eliminate more residue than the Ferric chloride (FeCl_3) coagulant,

despite the former having little effect on the water quality. Given that the contaminated water was already within the standard range, the Calamansi coagulant removed the contaminant (soil) successfully, and is thus more effective. Out of the ten trials of the coagulant, Trial 8 which used 4.0 g of Calamansi waste accumulated the most residue while still within the standard range. All trials from the Calamansi and Ferric chloride samples resulted in brown tinted water rich in Iron. The experiment only executed water coagulation and required flocculation, clarification, and filtration to achieve total water purification.

The researchers were able to produce an eco-friendly, portable, and accessible water coagulant through Calamansi waste utilization. Succeeding studies may explore further modifications on the current design to produce a highly-effective, organic effervescent water purifier from Calamansi scraps.

5. ACKNOWLEDGMENTS

The team would like to express their gratitude to their beloved family and friends for their continuous support. They would also like to thank their research mentors, Dr. Archie Maglaya and Professor Melchizedek Alipio, for the teachings and knowledge they bestowed upon them in creating the research paper. They are also grateful to their research advisor, Professor Gian Lim, for constantly guiding them on our chosen topic and sharing his insights that helped the team write this paper. The paper would not be made possible without them. Lastly, the group would like to thank God for protecting them from harm and giving them the strength to overcome any adversities that came their way while doing this study.

6. REFERENCES

- Aquaread. (n.d.). Salinity. <https://www.aquaread.com/parameters/salinity>
- Araneta, G. (2020). Research on calamansi peels receives 750k DOST funding. Retrieved From <https://region9.dost.gov.ph/news/899-research-on-calamansi-peels-receives-570k-dost-funding>
- Dollah, Z., Abdullah, A. R. C., Hashim, N. M., Albar, A., Badrealam, S., & Mohd Zaki, Z. Z. (2019). Citrus fruit peel waste as a source of natural coagulant for water turbidity removal. *Journal of Physics: Conference Series*, 1349, 012011. <https://doi.org/10.1088/1742-6596/1349/1/012011>
- Kent Ro Systems. (n.d.). What are Total Dissolved Solids (TDS) & How to Reduce Them? <https://www.kent.co.in/blog/what-are-total-dissolved-solids-tds-how-to-reduce-them/>



- Lenntech (n.d.). Water conductivity. <https://www.lenntech.com/applications/ultrapure/conductivity/water-conductivity.htm#:~:text=Pure%20water%20is%20not%20a,the%20concentration%20of%20ions%20increases.>
- Oram, B. (n.d.). The pH of water. <https://water-research.net/index.php/water-treatment/tools/the-ph-of-water#:~:text=The%20pH%20scale%20ranges%20from%200%20to%2014.&text=In%20general%20C%20a%20water%20with,groundwater%20systems%206%20to%208.5.>
- Safe Drinking Water Foundation. (n.d.). Conventional water treatment: Coagulation and filtration. <https://www.safewater.org/fact-sheets-1/2017/1/23/conventional-water-treatment>
- Safe Drinking Water Foundation. (n.d.). TDS and pH. Retrieved from <https://www.safewater.org/fact-sheets-1/2017/1/23/tds-and-ph>
- Water.org. (n.d.). Philippines. <https://water.org/our-impact/philippines/>
- What Is Adsorption? (2016). Fluence. <https://www.fluencecorp.com/what-is-adsorption/>
- World Health Organization. (2019). Water shortage in the Philippines threatens sustainable development and health. <https://www.who.int/philippines/news/feature-stories/detail/water-shortage-in-the-philippines-threatens-sustainable-development-and-health>



Survey on Traditional Mangrove Crab Identification Methods of Filipino Fishermen

Qiuting W. Cai, Janella Kristine C. Chua, Evanae Schon N. Magpayo,
Ali Alexandra Heart G. Po, and Jennifer O. Sanchez
De La Salle University Integrated School, Manila

Abstract: The Philippines is one of the largest producers of mangrove crabs in the industry, but only three of the four *Scylla* species exist in the country. As one of the largest mangrove crab exporters, Filipino crab farmers must distinguish their harvest before catching them for crab farming since the growth and needs of crabs depend heavily on their species group. To determine the accuracy of widely used local traditional methods, survey questions were distributed to 34 respondents around the Philippines through selected online platforms. Data gathered included local methods for identifying mangrove crabs based on traditional ecological knowledge and experiences of the local fishers interviewed. The study found that 70.58% of those polled identify the species of crabs by looking at their claws and 55.88% observe the color of the crabs. Furthermore, 41.17% of respondents consider the width and size of the shell, while 11.76% examine the crabs' carapace. Unique methods to certain regions were reported, including observation of minor features and behavior of the crabs and reliance on texture, weight, and season. Difficulty in species identification of juvenile crabs has been reported but was also possible when the crabs turn 2-3 months old or grow to the size of a 5-peso coin or 5 centimeters. Feeding schedules and consistent pond management are also said as crucial tasks in growing mangrove crabs. The fishermen voiced out concerns and opinions regarding the technology development and government policies in the crab industry.

Key Words: Philippines; mangrove crabs; *Scylla serrata*; species identification; traditional methods

1. INTRODUCTION

The Philippines, alongside Indonesia, Thailand, and Vietnam, remains one of the top exporters for mangrove crabs in the Southeast Asian region; as of 2018, it is estimated that over 18,100 tonnes of mangrove crabs have been exported from the Philippines to the global market all over the world (Yxtung, 2020). Now, mangrove crab industries are significantly affecting the

Philippines' economy as it was known to be the world's second-largest producer of mangrove crabs in the year 2013 for producing over sixteen thousand tonnes of mangrove crabs, valuing around 5.2 billion pesos (Quinitio & Parado-Estepa, 2017). Additionally, as of the year 2018, a total of 20,762 metric tonnes of mangrove crabs (Aquaculture production, 2018). In the Philippines, three out of the four mangrove crab species, under the genus *Scylla*, are known, namely *S. serrata*, *S. olivacea*, and *S. tranquebarica* (Keenan et al., 1998). Mangrove crabs grow not continuously but mature through the stages of molting, which is the shedding of the old exoskeleton of the shell and replacing it with a new and protective layer (Shelli & Lovatelli, 2011). Molting lets the mangrove crab

develop from the early larval stage to the megalopae to the juvenile stage and eventually to the sexually mature stage. This study focuses on the juvenile and adult stages and is based on environmental factors that may take 5-12 days from the megalopae stage (Meynecke & Richards, 2014).

In species identification, there are a lot of ways to identify the type of mangrove crab captured. In morphological techniques, crabs are classified through frontal lobe spine shape, carapace features, inner carpus spine, and shape of the cheliped dactyl prominences. However, mangrove crabs' physical parts only have minimal differences and are very hard to see through the naked eye. As a result, morphometric methods and molecular markers were introduced to improve accuracy. These techniques take a long time to execute and require many samples to experiment on, so it is not feasible for fishers to perform these methods (Hoq & Alam, 2018). Even though there are many studies about the taxonomy of mangrove crabs, there is still not enough research conducted to prove the traditional methods of fishers to differentiate species of genus *Scylla*. Additionally, people have not yet found a way to efficiently determine mangrove crab species without gadgets and



equipment.

This research's main objective is to determine the different traditional methods fishers use to identify mangrove crabs here in the Philippines. The researchers also aim to identify the similarities and differences of species identification methods used by crab farmers in several localities from Luzon, Visayas, and Mindanao and determine which methods are commonly used by them.

2. METHODOLOGY

2.1 Sampling and Data Collection

In this research, the respondents were primarily mangrove crab growers and traders from different regions in the Philippines. All participants in the study came from Regions I and V in Luzon, Regions VI and VIII in the Visayas, and Regions IX, X, and CARAGA in Mindanao, all with high productions of mangrove crabs. The target number of respondents in this research was 30 respondents from the specified regions all over the country, and 34 respondents participated in the research. The data was gathered through the use of online platforms, with the duration of the survey running from November 2020 to January 2021. Data from the survey was used to assess the efficacy of crab fishers' species identification methods. The survey was conducted through Google Forms and was distributed through Facebook as the researchers joined in private groups with local mangrove crab farmers. Messenger was also utilized for private messages, especially for follow-ups from target participants. Since internet connection is required on the mentioned platforms, text messaging and calls were also considered as backup plans. Text loads were provided to some of the respondents to communicate their responses and other concerns to the researchers

2.2 Survey Questions

The survey questions were divided into the following groups:

A. On mangrove crab production - The questions address how much mangrove crabs are produced and exported in the local and international trading and the effect of misidentification on production success.

B. On species identification of mangrove crabs - Questions in this group mainly focus on the features or parts the fishers check to identify the mangrove crabs, the methods used in species identification, and their importance.

C. On environmental changes affecting harvest, catch, and production - These questions mainly delve into any changes that can affect the

harvest and production of mangrove crabs and how and why such changes affect harvest and production.

D. On general mangrove crab fishing and farming practices - These questions focus on learning about the daily routine of a mangrove crab fisher during certain periods and the routines done to ensure a higher increase in harvesting the mangrove crabs.

2.3 Data Analysis

The study utilized both qualitative and quantitative research. The qualitative approach gave an in-depth understanding of the different species identification crab fishers use to identify *Scylla serrata* while the quantitative approach aimed to evaluate the effectiveness of the methods by comparison of production rates even in environmental fluctuations. The data collected was used to assess the different species identification methods from Luzon, Visayas, and Mindanao and check the differences and similarities of these such methods. Moreover, the data mainly focused on the frequency of crab farmers using a certain species identification method and also cross-referenced the common and unique traditional methods mentioned with the scientifically discovered proved species identification, both locally and internationally. Opinions and statements of fishers regarding the importance and acceptance of knowledge in mangrove crab farming were also part of the processed data. The researchers assessed this information by comparing the responses about the methods used by the fishers to study the effectiveness of each considering the environmental factors in their respective localities and utilized the results to know if fishers around the Philippines widely use the efficient methods in order to determine how the accuracy and knowledge of the methods impact the country's overall crab trading and production rates. Additionally, the insights and statements collected from the crab farmers were summarized for the researchers to explore more possibilities of new knowledge and lifestyles in mangrove crab farming for future studies conducted by other researchers in the same field.

3. RESULTS AND DISCUSSION

In the Philippines, three out of the four mangrove crab species, under the genus *Scylla*, are known, namely *S. serrata*, *S. olivacea*, and *S. tranquebarica* (Keenan et al., 1998). As one of the largest producers of mangrove crabs in the industry, it is vital that crab farmers need to distinguish their harvest before farming to avoid over-harvesting. Although numerous studies about the taxonomy of mangrove crabs have been conducted, there is still not enough research involving the traditional methods of fishers in differentiating the different species of genus *Scylla* without gadgets and equipment efficiently.



This is why the researchers have decided to survey 30 Filipino mangrove crab farmers from Regions III, V, VI, VIII, IX, X, and CARAGA to determine the various traditional methods fishers use in identifying mangrove crabs in the Philippines. With this, the researchers have further analyzed what similarities and differences their respective methods have from each other and which among these obtained methods are most commonly used.

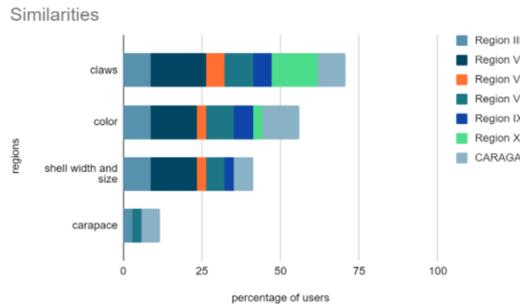

Graph 1. Similarities of Species Identification Methods

Graph 1 reveals that 70.58% of the respondents stated that they identify crabs species by observing their claws. According to them, the claws of *Scylla serrata* are usually larger than other species, and that the edges of their claws have more visible sharp “edges” or spine, and its color varies from dark green to purple. It also appears that 55.88% of the respondents observe the color of the crabs. The farmers pointed out that the chelae color of *Scylla serrata* is normally dark green or blue green. *Scylla olivacea* has a reddish brown hue, while *Scylla tranquebarica* is a vibrant purple, and *Scylla paramamosain*, which only 2.94% of the respondents are familiar with, has a light green color. White spots occur on the claws of the *Scylla serrata* and the back of its shell, according to 5.88% of respondents. Moreover, the graph indicates that observation of the width and size of the shell is 41.17%, *S. olivacea* is said to have a carapace diameter of 20.8-140.0 mm. *S. tranquebarica* has a carapace that measures 40.0-195.0 mm, while *S. serrata* has a carapace that measures 24.4-172.0 mm. Seasonal variations, on the other hand, will affect this. 41.17% of the respondents use this approach to assess the breadth and height of the shell. Another way to differentiate adult crab species is to search for inner carpus spines and the cheliped's dactyl prominence shape, which is blunt in *S. olivacea*. While only 11.76% of the respondents observe the crabs' carapace to identify chelipeds, search for their relative sizes and spines. Many fishers use various unique methods that are not found in other regions surveyed and instead base their species identification on mangrove crabs' appearances. This includes observing the crab's shape, checking the crab's back and feet, observing the color of the crab's bottom, sizing the claws, observing the venation at the

back and the legs, and finally, checking the mouth of the crab. Some fishers can also determine the crab species by feeling the texture of the shells, weighing the crab, depending on the season, and observing how the crab walks. The percentage of users performing the aforementioned methods with their specific originated regions are illustrated in the graph below:

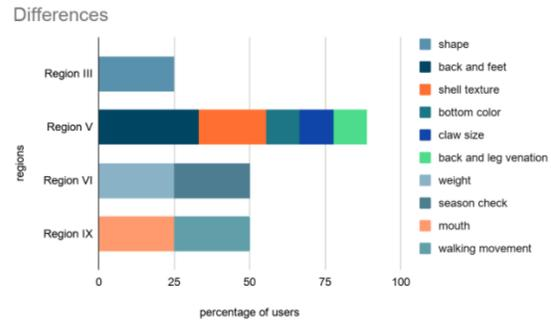

Graph 2. Differences of Species Identification Methods

However, the most precise approach is to identify the polygonal patterns on the thighs among these methods. However, the crabs' burrowing habits can cause them to change shape (Vince-Cruz Abeledo, Ting & Ablan-Lagman, 2018). Observing the white spots on the back of the shell is another practice that was not listed, suggesting that farmers have traditional ecological knowledge that has not been recorded or researched. The carpus spine, frontal spine, propodus spine, polygon patterns on chelipeds and pereopods, and carapace coloration, according to Hoq & Alam (2018), are used to classify mangrove crab species, especially those belonging to the genus *Scylla*. According to Lebata, Vay, Primavera, Walton, & Biñas (2007), the different groups of mangrove crabs under the genus *Scylla* are morphologically differentiated through color patterns. Meynecke, et al. (2010) discussed seasonal variations and environmental disparities that influence crab preferences, but they were not used as a mechanism for species identification.

Aside from the traditional methods, the researchers also considered the differences in identifying juvenile species and adult species. Crab farmers from Region III, V, VIII, IX, and CARAGA found it challenging to identify juveniles until they turn 2-3 months old; because as these crabs turn into adults, sometimes they turn out to be different species. In connection to this, respondents from Regions V and X continued to expound that once juvenile crabs grow into the size of a 5 peso coin or 5 cm, they will be identifiable through their claws and color. Besides differentiating juveniles from adult species, the researchers also concluded that when it came to pond management, all respondents believed



in doing site security surveys both for theft and biohazards twice a day. Moreover, all of the respondents believed in the importance of checking their ponds' water condition, perimeter fence, pests, dike, and surface to see if there are any issues present. Furthermore, the respondents were also very particular about maintaining their ponds salinity and pH level for crab growth since salty ponds are more favored by crabs, but excess salt may also cause them to grow slowly. Lastly, the crab farmers also mentioned how water temperature, level, and cleanliness significantly affect production.

4. CONCLUSIONS

Survey forms were distributed to 34 local fishers from Regions III, V, VI, VIII, IX, X, and CARAGA of the Philippines. The researchers found that methods across regions showed similarities in species identification, and some techniques are unique to specific regions through quantitative and qualitative data analysis. The most common practice in the Philippines for identifying mangrove crab species is through observation of the claws followed by observing the color, both of which are common in all surveyed regions. On the other hand, most reported unique methods come from Region V, including checking the crab's back and feet, feeling the shell's texture, observing the color of the bottom, and checking for venation on the back and the legs. Observation of the carapace pattern and checking the width and size of the shells are techniques done by a portion of the surveyed population and are methods reflected in published papers. Dependence on the season was used to determine the crab species and was discussed in a published paper but not as a method of species identification. Traditional ecological knowledge is said to be preserved after seeing that the observation of white spots on the shells is done across different regions and is not mentioned in any studied articles as well as other methods that can be found only in certain regions. Fishers from five out of the seven regions surveyed expressed how it was much more difficult, and to some impossible, to identify langaw-langaws or fly-sized crablets. In contrast, some fishermen from CARAGA and Region VI were confident that fly-sized crablets were identifiable by looking at their colors and the season. The fishermen were quite particular about the pond's management, particularly its water condition, depth, temperature, and security. They also highlighted the importance of maintaining a one-meter depth, a consistent feeding schedule, ensuring that the crabs are fed and monitored regularly, and frequently renewing the pond's water. Lastly, the researchers were also able to collect some of the fishermen's concerns and responses, like how they agreed that harsh and unpredictable weather conditions like rising sea levels

could affect the growth of crabs. They also raised their concern on current government policies, illegal fishing, theft, and how they ultimately want to gain support from Local Government Units. Fishers also voiced their queries on how they want to apply the latest technology to help them be more knowledgeable and have an overall easier time identifying different crab species. 30 out of the 34 respondents were willing to learn an easier method of species identification as long as it does not compromise accuracy.

5. ACKNOWLEDGMENTS

The researchers would like to show their most profound appreciation to Doctor Chona Camille Vince-Cruz Abeledo, the group's research adviser, and Miss Hilarie Orario, assistant research adviser, for supervising the group throughout the research process. The researchers would also like to extend their greatest gratitude to the following people who translated the survey questionnaires and answers from respondents: Jaron Acha, Betina Grace Tan and Jewel Alexei Buot Image for the Bisaya translation, Divine Laciste, Kyna Dominique Palattao, and Amalia Ediezca for the Ilocano version, and Joanna Nicole Wang for the translation in Ilonggo.

6. REFERENCES

- Abeledo, C. C.-C. (2018). A feast of (crab) kings [Image]. Retrieved from SHE-ENSYA:
<https://sheensya.wordpress.com/2018/05/10/a-feast-of-kings/>
- Alberts-Hubatsch, H., Lee, S. Y., Meynecke, J.-O., Diele, K., Nordhaus, I., & Wolf, M. (2015). Life-history, movement, and habitat use of *Scylla Serrata* (Decapoda, Portunidae): Current knowledge and future challenges. *Hydrobiologia*, 763(1), 5–21. <https://doi.org/10.1007/s10750-015-2393-z>
- Aldon, E. T., & Dagoon, N. J. (1997). The market for mudcrab. *SEAFDEC Asian Aquaculture*, 19(3), 11-13.
- Allan, G. (2004). Mud Crab Aquaculture in Australia and Southeast Asia. Australian Centre For Industrial Agricultural Research.
- Aquaculture Production. (2018). Bureau of Fisheries and Aquatic Resources. BFAR On-line Information System.
<https://www.bfar.da.gov.ph/profile?id=14&fbclid=IwAR0ppdgQaTwhlf%09adQ4nGs>
- Balasubramanian, C. P., & Chandini, G. (2014). Diversification in coastal aquaculture: mud crabs. In *Training manual on health management practices for finfish and shellfish of brackishwater environment* (pp. 12-29). Central Institute of Brackishwater Aquaculture.
- Bandibas, M. B. (2015). Crab biodiversity under different management schemes of mangrove ecosystems. *Global Journal of Environmental Science and Management*, 2(1), 19-30. <http://dx.doi.org/10.7508/gjesm.2016.01.003>
- Basconillo, J., Lucero, A., Solis, A., Sandoval, Jr., R., Bautista, E., Koizumi, T., & Kanamaru, H. (2016). Statistically Downscaled projected changes in seasonal mean temperature and rainfall in Cagayan Valley, Philippines. *Journal of the Meteorological Society of Japan*. Ser. II, 94A(0), 151-164. <https://doi.org/10.2151/jmsj.2015-058>



- Berkes, F., Colding, J., & Folke, C. (2000). Rediscovery of traditional ecological knowledge as adaptive management. *Ecological Applications*, 10(5), 1251-1262. [https://doi.org/10.1890/1051-0761\(2000\)010\[1251:roteka\]2.0.co;2](https://doi.org/10.1890/1051-0761(2000)010[1251:roteka]2.0.co;2)
- Castrance-Gonzales, R., Gorospe, J. G., Torres, M. A. J., Vicente, H. J., Roa, E. C., & Demayo, C. G. (2018). The Fishery of the Mangrove Crabs, *Scylla* spp in Three Selected Areas of the Philippines. *Transactions on Science and Technology*, 5(2), 155-170.
- Choo, J., Zent, E. L., & Simpson, B. B. (2009). The importance of traditional ecological knowledge for palm-weevil cultivation in the Venezuelan Amazon. *Journal of Ethnobiology*, 29(1), 113-128.
- Crear, B., Hart, P., Thomas, C., & Barclay, M. (2002). Evaluation of commercial shrimp grow-out pellets as diets for juvenile southern rock lobster, *Jasus edwardsii*. *Journal of Applied Aquaculture*, 12(3), 43-57. https://doi.org/10.1300/j028v12n03_05
- Davis, J. L., Eckert-Mills, M. G., Young-Williams, A. C., Hines, A. H., & Zohar, Y. (2005). Morphological conditioning of a hatchery-raised invertebrate, *Callinectes sapidus*, to improve field survivorship after release. *Aquaculture*, 243(1-4), 147-158. <https://doi.org/10.1016/j.aquaculture.2004.09.027>
- De La Cruz, J. (2020). Expert warns crab farmers against 'fake' king crabslets. *Seafdec*. <https://www.seafdec.org.ph/2020/expert-warns-crab-farmers-against-fake-king-crabslets/>
- Dissanayake, A., Galloway, T. S., & Jones, M. B. (2008). Physiological responses of juvenile and adult shore crabs *Carcinus maenas* (Crustacea: Decapoda) to pyrene exposure. *Marine Environmental Research*. <https://doi.org/10.1016/j.marenvres.2008.07.006>.
- Estampador, E. P., (1949). Studies on *Scylla* (Crustacea: Portunidae) I. Revision of the genus. *The Philippine Journal of Science*, 78, 95-109.
- Fazhan, H., Waiho, K. & Ikhwanuddin, M. (2017). Non-indigenous giant mud crab, *Scyllaserrata* (Forskål, 1775) (Crustacea: Brachyura: Portunidae) in Malaysian coastal waters: a call for caution. *Mar Biodivers Rec* 10, 26 (2017). *Marine Biodiversity Records*. <https://doi.org/10.1186/s41200-017-0128-8>
- Fazhan H, Waiho K, Quintino E, et al. (2020). Morphological descriptions and morphometric discriminant function analysis reveal an additional four groups of *Scylla* spp. *PeerJ*. <https://doi.org/10.7717/peerj.8066>
- Fielder, D.F. & Heasman, M.P. (1978). The mud crab. A Queensland Museum Booklet. Queensland Museum.
- Fisheries Statistics of the Philippines 2017-2019. (2020). Philippine Statistics Authority. <https://psa.gov.ph/sites/default/files/Fisheries%20Statistics%20of%20the%20Philippines%2C%202017-2019.pdf>
- Fisheries Statistics of the Philippines 2016-2018. (2019). Philippine Statistics Authority. <https://psa.gov.ph/sites/default/files/Fisheries%20Statistics%20of%20the%20Philippines%2C%202016-2018.pdf>
- Fuseya, R. & S. Watanabe. (1996). Genetic variability in the mud crab genus *Scylla* (Brachyura: Portunidae). *Fisheries Science*, 62, 705-709.
- FAO (2015). Global Forest Resources Assessment 2015: Desk Reference. UN Food and Agriculture Office. <http://www.fao.org/forest-resources-assessment/past-assessments/fra-2015/en/>
- Google Forms. (2018). Google Tools Meets Middle School, 127-142. doi:10.4135/9781506360188.n7
- Hoq, E., & Alam, M. S. (2018). Morphometric identification of mud crabs of the genus *Scylla* available in Bangladesh waters. *Bangladesh Journal of Fisheries*, 30(2), 19-206
- Houde, N. (2007). The six faces of traditional ecological knowledge: challenges and opportunities for Canadian co-management arrangements. *Ecology and Society*, 12(2).
- Inglis, J. (Ed.). (1993). *Traditional ecological knowledge: Concepts and cases*. IDRC.
- J.-O. Meynecke, R. G. Richards, (2014) A full life cycle and spatially explicit individual-based model for the giant mud crab (*Scylla serrata*): a case study from a marine protected area. *ICES Journal of Marine Science*, 71(3), 484-498. <https://doi.org/10.1093/icesjms/ftt181>
- Kathirvel, M. & Srinivasagam, S. (1992). Resource and Exploitation of Mud Crab *Scylla serrata* (Forskål) in India. *BOBP, Madras (India)*: 85-94.
- Keenan, C., Davie, P. & Mann, D. (1998). A revision of the genus *Scylla* De Haan, 1833 (Crustacea: Decapoda: Brachyura: Portunidae). *The Raffles Bulletin of Zoology* 46: 217-245.
- Lebata, M. J., Vay, L. L., Primavera, J. H., Walton, M. E., & Biñas, J. B. (2007). Baseline assessment of fisheries for three species of mud crabs (*Scylla* spp.) in the mangroves of Ibaday, Aklan, Philippines. *Bulletin of Marine Science*.
- Leland, J. C., Bucher, D. J., Southern Cross University., & Fisheries Research and Development Corporation. (n.d.). Direct age determination with validation for commercially important Australian lobster and crab species: Western, Eastern, Southern and ornate rock lobsters, and crystal, giant and mud crabs.
- Le Vay, L., Ut, V. N., & Jones, D. A. (2001). Seasonal abundance and recruitment in an estuarine population of mud crabs, *Scylla paramamosain*. <https://doi.org/10.1023/A:1017511002066>
- Meynecke, J.-O., Lee, S. Y., Grubert, M., Brown, I., Montgomery, S., Gribble, N., . . . Gillson, J. (2010). Evaluating the environmental drivers of mud crab (*Scylla serrata*) catches in Australia.
- Molt. (n.d.) [Image]. Retrieved from New World Encyclopedia: <https://www.newworldencyclopedia.org/entry/Molt>
- Moreau, E. (2020). Facebook Messenger: Everything You Need to Know. *Lifewire*. <https://www.lifewire.com/facebookmessenger-4103719>
- Naim, D. M., Nor, S. A. M., & Mahboob, S. (2020). Reassessment of species distribution and occurrence of mud crab (*Scylla* spp., Portunidae) in Malaysia through morphological and molecular identification. *Saudi Journal of Biological Sciences*, 27(2), 643-652. <https://doi.org/10.1016/j.sjbs.2019.11.030>
- Nakashima, D., & Roué, M. (2002). Indigenous knowledge, peoples and sustainable practice. *Encyclopedia of global environmental change*, 5, 314-324.
- P. J. Smith, W. R. Webber, S. M. McVeagh, G. J. Inglis & N. Gust (2003) DNA and morphological identification of an invasive swimming crab, *Charybdis japonica*, in New Zealand waters. *New Zealand Journal of Marine and Freshwater Research*, 37:4, 753-762
- Paterson, B. D., & Mann, D. L. (2011). Recent Advances and New Species in Aquaculture. *Mud Crab Aquaculture*. <https://doi.org/10.1002/9781444341775.ch4>
- Pritt, B. S. (2015). Molecular diagnostics in the diagnosis of parasitic infection. *Methods in Microbiology*. <https://doi.org/10.1016/bs.mim.2015.05.001>
- Province of Lanao del Norte. (2016). Gov't. plans to make Lanao Del Norte the "Crab capital of the Philippines". <https://lanaodelnorte.gov.ph/2016/02/17/govt-plans-to-make-lanao-del-norte-the-crab-capital-of-the-philippines/>
- Quinn, N. J. & Kojis, B. L., (1987). Reproductive Biology of *Scylla* Spp. *Bulletin of Marine Science* 41, 234-241.
- Quinitino, E. T., & Parado-Esteva, F. D. (2017). Development of a sustainable mangrove crab industry through science-based research. *Fish for the People*, 15(1), 47-51.
- Rinkevich, S., Greenwood, K., & Leonetti, C. (2011). Traditional ecological knowledge for application by Service scientists. *US Fish and Wildlife Service*.



3RD DLSU SENIOR HIGH SCHOOL RESEARCH CONGRESS

SUSTAINABILITY, ENVIRONMENT,
AND ENERGY

- Saylor, C. R., Alsharif, K. A., & Torres, H. (2017). The importance of traditional ecological knowledge in agroecological systems in Peru. *International Journal of Biodiversity Science, Ecosystem Services & Management*, 13(1), 150-161.
- Silbiger, N., & Munguia, P. (2008). Carapace color change in *Uca pugilator* as a response to temperature. *Journal of Experimental Marine Biology and Ecology*, 355(1), 41-46. <https://doi.org/10.1016/j.jembe.2007.11.014>
- Shelley, C., & Lovatelli, A. (2011). *Mud crab aquaculture: a practical manual*. FAO Fisheries and aquaculture technical paper, (567), I. <https://doi.org/10.1002/9781444341775.ch4>
- Taylor, M. L. (1984). New species of mud crab found in Western Australia. *FINNS*, 17(2), 15-18. Triño, A. T. (2000). Aqua-mangrove integrated farming: Shrimp and mud crab culture in coastal and inland tidal flats with existing reforested or natural growth of mangroves. *Technologies in Mangrove-Friendly Aquaculture. Final Report of and Papers Presented to the On-Site Training on Mangrove-Friendly Aquaculture*, Hai Phong City, Socialist Republic of Vietnam, 19-30 April 1999 (pp. 157-188). Aquaculture Department, Southeast Asian Fisheries Development Center.
- Vincecruz-Abeledo, C. C., & Lagman, M. C. A. (2018). A revised dichotomous key for the mangrove crab genus *Scylla* De Haan, 1833 (Brachyura, Portunidae). *Crustaceana*, 91(7), 847-865. <https://doi.org/10.1163/15685403-00003798>
- Vince Cruz-Abeledo, C. C., Ting, K., & Ablan-Lagman, M. C. (2018). Identification of a species diagnostic character for instar and juvenile mud crabs (Genus *Scylla*). *Aquaculture*, 491, 205-209. <https://doi.org/10.1016/j.aquaculture.2018.03.035>
- What are Facebook Groups? (n.d.). Big Commerce. <https://www.bigcommerce.com/ecommerce-answers/what-are-facebook-groups/>
- Williams, M. J., & Primavera, J. H. (2001). Choosing tropical portunid species for culture, domestication and stock enhancement in the Indo-Pacific. *Asian Fisheries Science*, 14(2), 121-142.
- Wu, Y. (2017). Periphyton and Its Study Methods. In *Periphyton*. <https://doi.org/10.1016/b978-0-12-801077-8.00001-6>
- Xytung (2020, August 16). Overview of the Mud (Mangrove) Crab industry in the Philippines (Q3-2019) | Industry Report. <https://www.ras-aquaculture.com/post/overview-of-the-mud-mangrove-crab-industry-in-the-philippines-q3-2019-industry-report>



Fish waste as a resource: An approach to lessen the impact of improper solid waste management in the Philippines

Sheralyn, T. De Ungria, Lara Therese T. Fernandez, Sophia Ellise F. Sabado,
Jeano Paulo E. Santos, Allysa Rose B. Sararaña,
and Chona Camille V. Abeledo,
De La Salle University Integrated School, Manila

Abstract: Improper solid waste management of fish waste contributes to the pollution leading the Comprehensive National Fisheries Industry Development Plan to declare that the Philippine aquaculture industry is unsustainable. The utilization of waste promotes a circular economy, whereby products are reused indefinitely in order to eliminate waste and boost sustainability in the fish industry. This study consists of surveys and interviews with fish vendors to determine the most efficient methods of reusing and disposing fish waste, and which of these are feasible within the Philippines, specifically Metro Manila. The data gathered could be useful in the creation of policies recommending ways on repurposing fish waste and promoting a circular economy. From the responses gathered, wet market fish stalls in Metro Manila produce 1.8 tons of fish waste a year, wherein the majority claimed that it was managed by being collected by garbage collectors and segregated; however, the protocols and practices of the interviewed wet markets were inconsistent. As implementation of protocols are not strictly enforced, current waste management methods remain ineffective in reducing solid waste. Therefore, educating those in the fish industry, enacting methods to recycle fish waste, and recommending them to LGUs would prove effective in developing a circular economy while providing another source of income for the fish industry.

Key Words: fish waste; waste management; valorization; sustainability; wet market

1. INTRODUCTION

A circular economy follows the principle of reducing the usage of raw materials, reusing materials to create new products, and recycling existing ones; it minimizes hazardous impacts to the environment without stopping economic growth (Johansson & Henriksson, 2020). In the 35,000 tons of municipal solid waste being generated every day, 15 to 60% of the uncollected waste is found polluting bodies of water in the Philippines (Plaza, 2017). Despite the approval of RA 9003 or “Ecological Solid Waste Management Act of 2000” aimed to institute sustainable development by creating a comprehensive solid waste management (SWM) program; however, local government units (LGUs) have been unable to comply with the standards that the republic act requires (Castillo & Otoma, 2013). Due to improper waste disposal, the Comprehensive National Fisheries Industry Development Plan (CNFIDP) declared the Philippine aquaculture industry as unsustainable wherein fish waste such as bones, fins, skin, and scales, is one of the causes.

This study seeks to identify the actual amount of fish waste generated in the wet markets of Metro Manila, the existing SWM plans being implemented, and to find methods of converting fish waste into

useful products to contribute to the development of a circular economy. The valorization of fish by-products play an essential role in conserving marine resources, and solutions should be implemented to avoid the pointless discarding of valuable biomass (Lopes et al., 2015). This will help alleviate excessive solid waste production, promote a circular economy, and provide new sources of useful material such as animal feed, fertilizer, biopolymer extracts, and collagen for the utilization and usage of other special fields within the food, medicinal, cosmetic, and agricultural industries.

2. METHODOLOGY

2.1 Sampling and Data Collection Methods

Purposive sampling was used in selecting the 40 fish vendors who manage stalls in the wet markets of Metro Manila. Their perspectives about the processes of waste disposal, their knowledge of SWM policies, and possible uses for fish waste byproducts were obtained from interviews and survey questionnaires, while the average of fish waste produced in the Philippines every year, along with the frequency of its valorization after disposal were



acquired through extensive literature from various studies using 71 books, academic journals, and theses, collectively. Interviews were conducted with the help of family members and friends, who are able to go outside following quarantine protocols, by way of face to face verbal surveys in Metro Manila wet markets. Php 50.00 of prepaid load was given to each participant days after conducting the interview. Guide questions were given to the participants a few minutes prior which had given them ample time to prepare their answers. The overall interview process lasted from late November to late December.

The interviewees were asked to provide personal information such as job position, job experience (e.g. years in current job), and province or city of origin. They were given the choice to provide their name or age as long as they were aware of the risks and confidentiality of the study. The participants were interviewed on the same day and their responses were recorded and transcribed.

2.2 Data Analysis Strategy

The Framework Method was the data analysis strategy used for this study (Gale et al., 2013). Firstly, the data collected were manually categorized and grouped based on the similarities of the responses. Secondly, the organized data were illustrated into a framework showing the full process of fish waste disposal and currently practiced valorization methods. The framework was then used for cross-referencing to identify loopholes in current disposal practices and policies such as where the unused fish waste ends up and how it is handled. Following the identification of these issues, methods of reusing fish waste that Southeast Asian industries can profit from were determined. These can serve as a basis for the creation of a policy paper which implements a circular economy through an improved solid waste management system by the Philippine fish industry.

3. RESULTS AND DISCUSSION

3.1 Results

The data from the surveys state that the majority of fish waste produced in the wet market are innards, gills, and scales that are produced on a daily basis (Fig. 4.3.1a and Fig. 4.3.1b).

The data from the surveys state that the majority of fish waste produced in the wet market

are innards, gills, and scales that are produced on a daily basis (Fig. 4.3.1a and Fig. 4.3.1b).

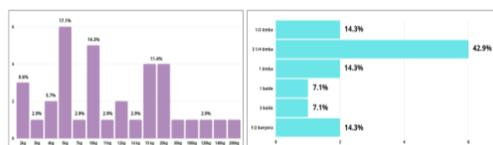

Fig. 4.3.1a Weight of Fish Waste produced (kilograms), and b. Weight of Fish Waste produced (containers)

With the amount of fish waste produced, 40% of respondents stated that their customers ask to acquire the fish waste for free, while some opt to buy it (22.5%). However, 37.5% of the respondents stated that fish waste isn't acquired from their stalls at all. In the stalls wherein fish waste is actually obtained, most customers buy around 1 to 2 kg of fish waste (Fig. 4.6.1a and Fig. 4.6.1b).

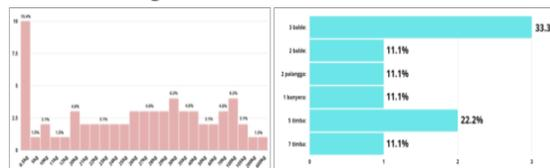

Fig. 4.6.1a. Weight of Fish Waste thrown out (kilograms) and b. Weight of Fish Waste thrown out (containers)

For fish waste that is thrown, 58.1% of the responses claim the waste is taken by garbage collectors or dump trucks, followed by the waste being given away (19.4%). Under SWM methods, the majority responded that waste produced by the vendors' stalls is collected by waste collectors (45%) and segregated (42.5%) while the rest stated it was maintained, unmanaged or given away, or that they did not know. Almost half of the respondents state that government units are responsible for managing wastes produced by vendors' stalls.

Most of the targeted wet markets implement policies like keeping the area clean (24.4%), placing waste proper containers (24.4%), and practicing proper disposal (15.6%) and segregation (13.3%). However, 20% claim that no such protocols are being implemented.

Regarding sanctions charged, the majority of the respondents (72.5%) stated that no penalties were imposed in their wet markets, while others (22.5%) claimed that penalties were given. These include being fined (55.6%), being given memos (22.2%), and other means of penalties accordingly.

The summary of responses for the possible uses for fish waste were animal food (63.6%) and fertilizer (11.4%). Several respondents also answered that there were no other uses for fish waste (9.1%) or that they did not know (9.1%).

3.2 Discussions

From the responses of the fish vendors, the specific parts of dead fish frequently being thrown were deemed as having little to no commercial value (Ahuja et al., 2020), hence being considered useless and labelled as "fish waste." This data supports the claim that the public market is the source that generates the most amount of solid waste (Environmental Management Bureau, 2016) as they produce fish waste on a daily basis, accumulating roughly 1.8 tons of fish waste a year. There are customers who obtain 1.5kg of fish waste everyday on



average, where 62.5% of them opt to utilize the fish waste, meaning each customer is able to repurpose around half a ton of fish waste annually and consequently reduce the amount of solid waste produced.

Among the 10 wet markets, five had inconsistent practices as there were varying practices in each, even though responses show that there were existing implementations in these markets. On the other hand, two among these have inconsistent practices and implementations as responses exhibit that only some practice them while a few are not aware or claim that there are none. While responses from one market were consistently observing one practice showing consistent presence of implementation, responses from another were consistently claiming there were no implementations. SWM methods in these markets correspond to the SWM program under RA 9003 where waste segregation and collection of solid waste are listed to manage solid waste (Aquino et al., 2013). Aligned with this is the assistance of LGUs in implementing SWM systems (Castillo & Otoma, 2013). Since more than half of the respondents gave the responsibility to market management or the store owner, it can be said that the LGUs have failed in leading the implementation of this program.

Although penalties are supposed to be imposed according to RA 9003 and Presidential Act No. 825, the majority of respondents claimed that there are none or were found to be unaware of the penalties. This proves that SWM is ineffective due to insufficient efforts by government agencies in implementing such penalties (Ngoc & Schnitzer, 2009). Despite the consequences per violation, this data implies that there is inadequate cooperation from citizens or fish vendors in waste collection methods (Environmental Management Bureau, 2018).

While a smaller percentage of fish vendors are unfamiliar with the alternate uses of fish waste or believe they have no uses, a significant portion managed to offer their knowledge related to repurposing their waste. Regarding utilization processes, results of this study show that 8 out of 10 fish vendors within Metro Manila have knowledge on repurposing fish waste as feed, fertilizer, leftovers, and clothing designs as their method of reducing the waste they produce.

Amongst the given alternative uses of fish waste obtained from the interview data, other unmentioned uses such as sources for biofuels and biopolymer extracts were found through extensive research. In this case, the methods of creating animal feed, fertilizer, leftovers, clothing designs, biofuels, and biopolymer extracts from fish wastes were further investigated. First, there are two types of animal feed that can be reprocessed from fish waste — fish silage,

a wet by-product liquefied by enzymes and acids (Zynudheen & Binsi, 2018), and fish meal, a by-product that is minced, cooked, and pressed to separate the solid cake from the liquid phase (Plazzota & Manzocco, 2019). Second, seeing that fish waste is rich in nutritive soil elements, decomposes rapidly, and is compatible with organic production systems, fish waste is a suitable material as fertilizer (López-Mosquera et al., 2011; Illera-Vives et al., 2015). Third, leftover fish parts can be used in meals such as chowder, stew, stock and more. Fourth, clothing such as leather can be produced from fish skin, an ancient tradition practiced by indigenous Arctic groups (Palomino et al., 2019). Fifth, through the method of fish waste conversion with transesterification — wherein the biomass reacts with alcohol — a nontoxic, pollution-free, and biodegradable biofuel can be created (Knothe et al., 2015). Lastly, since seafood by-products are a great source of biopolymers, certain extracts like chitin, chitosan, and collagen can be obtained depending on the method of extraction on a specific type of fish waste (Diez-Pascual, 2019). The methods to extract chitin, chitosan, and collagen include centrifugation, N-deacetylation and deacylation, and demineralization, respectively (Korma et al., 2016; Majekodunmi, 2016).

4. CONCLUSIONS

Throughout the research, the following objectives were accomplished:

The current state of fish waste management within the wet markets of the Philippines was observed by identifying the amount and frequency of waste produced, SWM practices, and the extent of the fish vendors' knowledge in fish waste valorization methods.

Methods of repurposing fish waste produced by wet markets were compiled and practices feasible in the Philippines and Southeast Asia were determined.

5. ACKNOWLEDGMENTS

We wish to extend our sincerest gratitude to our families, for their love, patience, unwavering support, and helpful participation, especially in providing the funds for our research and help in conducting interviews with the fish vendors. Together with the fish vendors, for participating in our study and sharing their time during their work hours to help us obtain data for our research.

6. REFERENCES

Ahuja, I., Dauksas, E., Remme, J. F., Richardsen R., & Løes, A. (2020). Fish and fish waste-based fertilizers in organic farming—with status in Norway: A review.



- Waste Management, 115, 95-112. <https://doi.org/10.1016/j.wasman.2020.07.025>
- Aquino, A. P., Derequito, J. A. P., Festejo-Abeleda, M. A. (2013, December 9). Ecological solid waste management act: Environmental protection through proper solid waste practice. <https://ap.iftc.org.tw/article/588#:~:text=Waste%20mismanagement%20has%20serious%20environmental,garbage%20problems%20in%20the%20country>.
- Castillo, A., & Otoma, S. (2013). Status of solid waste management in the Philippines. https://www.jstage.jst.go.jp/article/jsmcwm/24/0/24_677/_pdf.
- Diez-Pascual, A. M. (2019). Synthesis and applications of biopolymer composites. *International Journal of Molecular Sciences*, 20(9), 1-7. <https://doi.org/10.3390/ijms20092321>
- Environmental Management Bureau. (2016). National Solid Waste Management Strategy 2012-2016. <https://nswmc.emb.gov.ph/wp-content/uploads/2016/07/NSWM-Strategy-2012-2016.pdf>
- Environmental Management Bureau. (2018). National solid waste management report. <https://emb.gov.ph/wp-content/uploads/2019/08/National-Solid-Waste-Management-Status-Report-2008-2018.pdf>
- Gale, N.K., Heath, G., Cameron, E., Rashid, S., & Redwood, S. (2013). Using the framework method for the analysis of qualitative data in multi-disciplinary health research. *BMC Medical Research Methodology*, 13(117), 1-8. <https://doi.org/10.1186/1471-2288-13-117>
- Illera-Vives, M., Seoane Labandeira, S., Brito, L.M., López-Fabal, a., López-Mosquera, M.E. (2015). Evaluation of compost from seaweed and fish waste as a fertilizer for horticultural use. *Scientia Horticulturae*, 186, 101-107. <https://doi.org/10.1016/j.scienta.2015.02.008>
- Johansson, N. & Henriksson, M. (2020). Circular economy running in circles? A discourse analysis of shifts in ideas of circularity in Swedish environmental policy. *Sustainable Consumption and Production*, 23, 148-156. <https://doi.org/10.1016/j.spc.2020.05.005>
- Knothe, G., Krahl, J., & Van Gerpen, J. (Eds.). (2015). *The biodiesel handbook*. Elsevier.
- Korma, S. A., Kamal-Alahmad, Niazi, S., Ammar, A., & Alyousef, H. (2016). Production, classification, properties and application of chitosan. *International Journal of Research in Agricultural Sciences*, 3(3), 2348-3997.
- Lopes, C., Antelo L. T., Franco-Uria, A., Alonso, A. A., & Pérez-Martín, R. (2015). Valorisation of fish by-products against waste management treatments – Comparison of environmental impacts. *Waste Management*, 46, 103-112. <https://doi.org/10.1016/j.wasman.2015.08.017>
- López-Mosquera, E., Fernández-Lema, E., Villares, R., Corral, R., Alonso, B., & Blanco, C. (2011). Composting fish waste and seaweed to produce a fertilizer for use in organic agriculture. *Procedia Environmental Sciences*, 9, 113-117. <https://doi.org/10.1016/j.proenv.2011.11.018>
- Majekodunmi, S. O. (2016). Current development of extraction, characterization and evaluation of properties of chitosan and its use in medicine and pharmaceutical industry. *American Journal of Polymer Science*, 6(3), 86-91. <http://article.sapub.org/10.5923.j.ajps.20160603.04.html>
- Ngoc, U. N., & Schnitzer, H. (2009). Sustainable solutions for solid waste management in Southeast Asian countries. *Waste Management*, 29(6), 1982-1995. <https://doi.org/10.1016/j.wasman.2008.08.031>
- Palomino, E., Káradóttir, K., Rhame, L., & Boon, J. (2019). Indigenous arctic fish skin clothing traditions: Cultural and ecological impacts on fashion higher education. https://www.researchgate.net/publication/334224302_Indigenous_Arctic_Fishskin_clothing_traditions-Cultural_and_ecological_impacts_on_Fashion_Higher_Education_Cumulus-Rovaniemi
- Plaza, A. B. (2017, October 13). Ditch NIMBY to fix Philippines' municipal solid waste problem. <https://blogs.adb.org/blog/ditch-nimby-fix-philippines-municipal-solid-waste-problem>
- Plazzota, S. & Manzocco, L. (2019). 10 - food waste valorization. *Saving Food: Production, Supply Chain, Food Waste, and Food Consumption*, 279-313. <https://doi.org/10.1016/B978-0-12-815357-4.00010-9>
- Zynudheen, A. A. & Binsi, P. K. (2018). Fish processing waste: Valuable raw material for silage, foliar spray and animal feed preparation. <http://drs.cift.res.in/bitstream/handle/123456789/4486/Fish%20processing%20waste.pdf?sequence=1>



Paper Review for Application of Thermally Treated Eggshell Waste: Systematic Approach

Yiesha Kyra N. Estrada, Nigel Joshua P. Santiago,
and Althea Brianna O. Zialcita
De La Salle University Integrated School, Manila

Arnel B. Beltran, *Research Adviser*
De La Salle University, Manila

Abstract: The amount of eggshell waste continues to rise due to the increased consumption of eggs; thus, finding methods to repurpose these waste materials would be beneficial. The estimated number of eggshell wastes in the Philippines for 2019 is 63.28 thousand metric tons. Moreover, eggshells also exhibit potential to have various applications due to their polycrystalline structure and calcite crystal content. The performance of eggshells in these applications can be maximized through thermal treatment, which involves exposing the eggshells to high temperatures for a period of time. Thus, this study aims to develop a framework using systematic mapping approach to evaluate the application of calcined eggshells. Through this method, relevant papers were collated, screened, analyzed, and evaluated. The findings showed that the application of calcined eggshells can be classified into seven general utilizations: catalysis, adsorption, additives, hydroxyapatite synthesis, bacteria removal, biogas production, and biomass gasification. Additionally, the resulting data indicated that chicken eggshells were the most used eggshell type for these applications. It was also noted that the usual temperature and time for thermal treatment ranges from around 500-1000°C for about 2-4 hours. Overall, the results suggest the possibility for eggshells, given the significant eggshell waste production in the country, to be utilized in different applications through thermal treatment.

Key Words: eggshell waste; thermal treatment; calcination; systematic mapping approach; waste utilization

1. INTRODUCTION

Eggshells are agricultural wastes that accumulate in landfills. The high concentration of waste causes environmental pollution (Abdulrahman et al., 2014). The increase in demand for eggs contributes to the increase in consumption of eggs. The United States Department of Agriculture (2020) stated that the consumption per year is around 13.4kg per person. The rise in egg production contributes to the high concentration of waste. Eggshell waste utilization helps reduce solid waste dumps in landfills because of its efficiency. Eggshells are composed of 94% calcium carbonate, 4% organic matter, 1% magnesium carbonate, and 1% calcium phosphate (Mohadi et al., 2016). Eggshells exhibit calcite crystals and polycrystalline calcium carbonate (Hincke et al., 2012). Calcination involves subjecting raw materials to extremely high temperatures which enhances the calcium carbonate content of eggshells (Wu et al., 2015). Ahmadzadeh-Hakimi et al. (2017) state that Scanning Electron Microscopy (SEM), Fourier-Transform Infrared Spectroscopy (FTIR), and X-ray

Diffraction (XRD) are utilized for characterization of eggshells. Characterization is performed to analyze the efficiency of calcined eggshells. Mohadi et al. (2016) states that the overall performance of calcined eggshells was highly effective compared to that of raw eggshells.

A systematic approach was used in this paper review to evaluate the relevance of the research topic. The study is limited to conducting a desktop study to determine its performance based on the significant results of existing literature from different sites. Sites used for the research were Scopus, Google Scholar, and Science Direct. The performance of calcined eggshell waste will be evaluated based on its properties and applications. The general objective of the study is to evaluate the application of thermally-treated eggshell waste through a systematic mapping approach. It is narrowed into three specific objectives, which are: 1) to formulate a framework for systematic mapping of the utilization of thermally-treated eggshell waste; 2) to evaluate the performance of thermally-treated eggshell wastes to its intended application, and; 3) to assess the properties of calcined



eggshell wastes that affect its performance. The study will examine the studied waste utilization and benefits as an adsorbent, catalyst, additive, bacteria removal, biogas production, hydroxyapatite synthesis, and biomass gasification. It will concentrate on the trend, calcination, and characterization of eggshell waste used to evaluate its performance in different functions.

2. METHODOLOGY

2.1. Research Framework

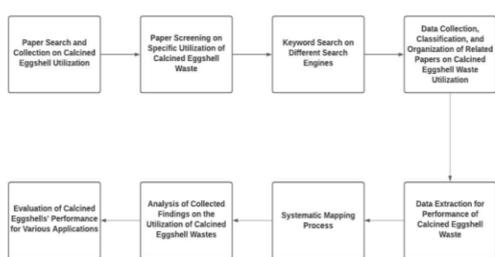

Fig 2.1. Research Flow

The research flow presented in Fig. 2.1 consists of ten steps. First, the formulation of the research questions was the initial point of the research. Then, the scopes and limitations were reviewed to analyze the restrictions of the research. Afterwards, paper search and collection were carried out to find significant research evidence. The gathered papers were screened to obtain optimum results. Furthermore, keywords were used to identify the scope of the papers being reviewed. Data collection, classification, and organization were employed to achieve a thorough synthesis of the papers. Moreover, information extracted from different papers were analyzed and evaluated for the calcined eggshells. Mapping process was used via the systematic approach to answer the research questions. Additionally, findings of the analysis were organized for visualization of the results. Lastly, the performance of thermally-treated eggshells for each application was evaluated to determine efficiency of calcined eggshells.

2.1.2. Research Questions

For this study, the following research questions (RQs) were formulated to be answered by the systematic approach for the applications of thermally-treated eggshell waste: RQ1: Is thermal treatment being utilized for eggshell waste?

RQ2: What are the applications of thermally treated eggshell wastes?

RQ3: What is the performance of thermally treated eggshell wastes to its intended application?

RQ4: What are the properties of thermally treated eggshell wastes that affect its performance?

2.2. Paper Search and Screening

The search for relevant papers related to the research questions was performed using the following search engines and databases: SCOPUS, ResearchGate, Google Scholar, and ScienceDirect. Then, during the initial paper search in these databases, the results were filtered with the following keywords as shown in Table 2.1.

Table 2.1. Keywords Used in the Initial Paper Search

	Keyword		Keyword
K1	"Eggshells"	K6	"Calcined eggshell"
K2	"Eggshell" + "Waste"	K7	"Calcined waste eggshell"
K3	"Waste eggshell"	K8	"Eggshell" + "Utilization"
K4	"Thermally treated eggshell"	K9	"Eggshell" + "Application"
K5	"Eggshell" + "Thermal treatment"	K10	"Eggshell" + "Adsorption"

2.3. Data Collection, Organization, and Analysis

The extraction of relevant information is necessary to answer the defined research questions. The collected papers were further screened as only relevant papers related to the study would be used for the paper review. Moreover, the significant performance, eggshell type, temperature, specific utilization, and general utilization were extracted from various papers and recorded in excel to achieve an organized data sheet. All papers were organized by placing its significant information, which is author, date published, journal abbreviation, type of eggshell, temperature of thermal treatment, duration of thermal treatment, significant results, highest performance, analysis used, and utilization. The group utilization was divided into different groups, which are Adsorbent, Bacteria Removal, Catalyst, Biomass Gasification, Additives, and Hydroxyapatite Synthesis. Since some sources did not state the type of eggshells used, the eggshell source for the unspecified eggshells were grouped as well.

3. RESULTS AND DISCUSSION

3.1 Philippine Egg Production, Waste Generation, and Eggshell Types

The increase in egg production per year has contributed to the increase in eggshell waste. As presented in Fig. 3.1, the amount of chicken eggs has



gradually increased for the past three years. During the year 2019, the production of both chicken and duck eggs are higher compared to 2017 and 2018. Moreover, the abundance of chicken eggs in the Philippines significantly outweigh that of duck eggs. This signifies the high supply and demand of chicken eggs in the country as they are one of the staple foods.

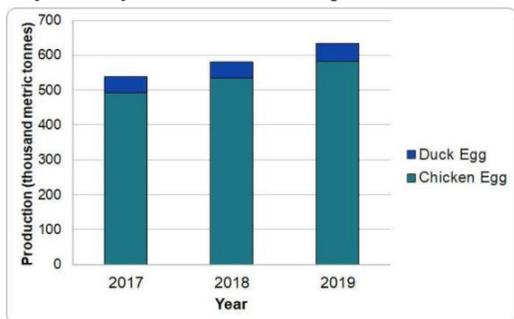

Fig. 3.1. Chicken and Duck Egg Production in the Philippines

It was determined that the shell is said to be 10% of the egg's total weight (Hunton, 2005). It was estimated that eggshell weighs 6g for every 60g egg (average weight). The projected eggshell waste for 2017, 2018, and 2019 were computed by multiplying the total egg supply to the percentage of eggshell per egg. The computed projected eggshell wastes for those years were 53.78 thousand metric tonnes, 58.05 thousand metric tonnes, and 63.28 thousand metric tonnes, respectively. As shown by Fig. 3.2, there has been an increase in eggshell projection which is relative to the egg production in the country.

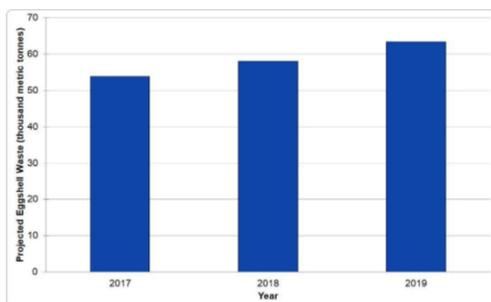

Fig. 3.2. Eggshell Waste from 2017-2019 (Note: computed as 10% of egg production)

Based on the data collected, there are three primary types of eggshells: quail eggshells, duck eggshells, and chicken eggshells. In Fig. 3.3, chicken eggshells rank the highest with 34 papers due to their abundance and accessibility. However, the number of unspecified eggshells remains higher with 52 papers. The type of eggshells used in some studies were not specified; however, their sources were mentioned. Figure 3.4 below shows the percentage of the different sources of unspecified eggshells. It depicts that waste eggshells were collected from street food stalls, bakeries, breakfast shops, food markets, poultry farms, and restaurants

from restaurants due to the large number of eggshell wastes from consumption. Despite identifying the study's source of eggshell waste, 53.8% remain to be unstated.

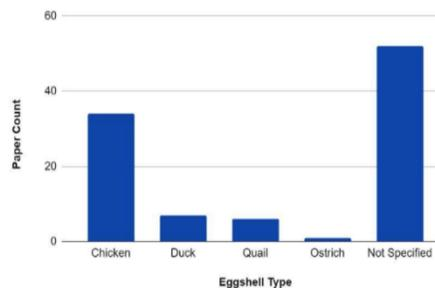

Fig. 3.3. Paper Count on the Eggshell Type Utilized

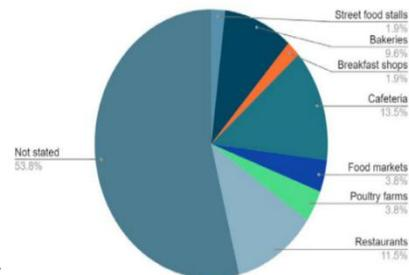

Fig. 3.4. Sources of Unspecified Eggshells

3.2. Thermal Treatment

Calcium carbonate content of eggshells are further maximized by the application of thermal treatment. The high temperature of calcination triggers the conversion of calcium carbonate calcium oxide and calcium hydroxide (Wu et al., 2015). Based from Fig. 3.5, the optimum calcination temperature used by many studies range from 500-1000°C for a duration of 2-4h. Awogbemi et al. (2020) stated that a calcination at 90°C affected the pore size, surface area, and thermal decomposition of eggshells. XRD patterns show that samples sintered beyond 1100°C shows a gradual disappearance of the β -TCP phase that is transformed to hydro (Wu et. al., 2015). Agbabiaka et al. (2020) found that a calcination temperature of 1000°C showed a hydroxyapatite structure, meaning a high purity rate. Furthermore, Mohadi et al. (2016)



states that metal oxide formation and calcination temperature are directly proportional.

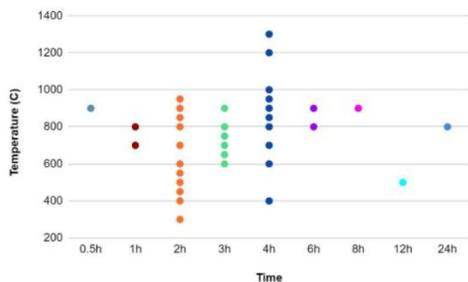

Fig. 3.5. Corresponding Time and Temperature for Calcination from Various Studies

3.3. Utilization, Application, and Performance

General Utilization, Specific Application, and Overall Performance

Thermally treated eggshell wastes have multiple utilizations: adsorption, catalyst, bacteria removal, biogas production, biomass gasification, hydroxyapatite synthesis, and additives. In Table 3.1, a total of 100 papers were used in this study to analyze each utilization. Based on different studies, chicken eggshells were more often used than other eggshell types. The performance of eggshells from various papers were assessed and analyzed in order to determine the efficiency of eggshells as an alternative product.

Table 3.1. Eggshell Waste Utilization Paper Count

General Utilization	Paper Count
Catalyst	47
Adsorption	25
Additives	14
Hydroxyapatite Synthesis	11
Bacteria Removal	1
Biogas Production	1
Biomass Gasification	1

Catalysis

Catalysts accelerate the chemical reaction between substances and improves the yield. The thermally-treated eggshells were used mainly for biodiesel production. The reaction process present in the studies was transesterification. Due to the calcium carbonate content in eggshells, the eggshell-derived catalyst showed great stability and high effectiveness. The majority of the studies utilized chicken eggshells as a catalyst. As shown in Fig. 3.6, the results for the

biodiesel yield range from 75-97.98%. This shows the efficiency of calcined eggshells as a catalyst for biodiesel production.



Fig. 3.6. Biodiesel Yield of Eggshell-Derived Catalyst

Adsorption

The presence of contaminants in water has adverse effects on human health and the environment. Eggshells were found to be effective adsorbents due to the calcium carbonate content and porous structure. As presented in Fig. 3.7, the overall efficiency of calcined eggshells for the adsorption of different contaminants ranged from 50-99.5%. Amongst the contaminants, phosphorus was the most prevalent due to its abundance in wastewater.

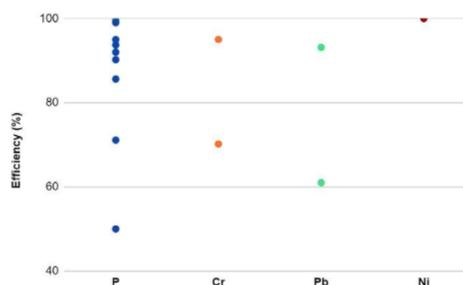

Fig. 3.7. Efficiency of Calcined Eggshells on Corresponding Contaminants

Additive

The thermally treated eggshells were combined with other products to enhance the quality and capability of the final product. In Fig. 3.8, the temperatures through which the highest performance of calcined eggshells as additives are exhibited. Specifically, a calcination temperature of 800°C was commonly used by multiple studies for this application. The calcination temperature is vital in



obtaining optimal performance. The eggshell type used in these studies were not specified.

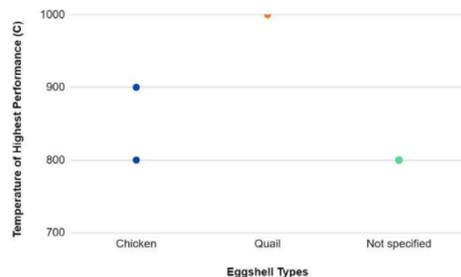

Fig. 3.8. Temperature of Highest Performance for Corresponding Eggshell Types

Hydroxyapatite Synthesis

The calcium carbonate present in eggshells can be converted to crystalline hydroxyapatite. Eggshells were found to have high thermal stability which is advantageous for hydroxyapatite synthesis. Calcination was performed to aid in calcium oxide formation and produce high quality hydroxyapatite (Ummartyotin & Tangnorawich, 2015). In Fig. 3.9, the Ca/P ratio is optimal as it ranges from 1.56-2.44. The results were limited because most studies use chicken eggshells in the study. Oladele et al. (2019) state that calcination is a factor that improved the synthesis of hydroxyapatite.

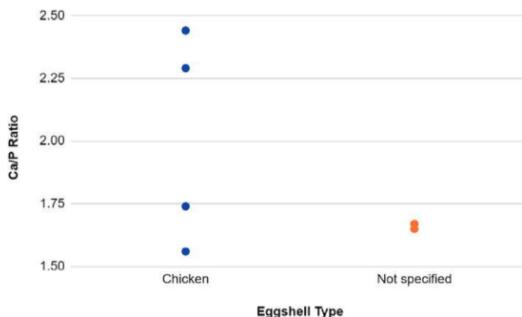

Fig. 3.9. Ca/P Ratio of Hydroxyapatite with Corresponding Eggshell Type

Other Utilizations (Bacteria Removal, Biogas Production, and Biomass Gasification)

As abundance of human pathogen and antibiotic resistance genes within landfills has become a great threat to human health, bio sorbents from agricultural wastes provide economic and environmental benefits towards the prevention of its dissemination. Ye et. al (2017) stated that eggshells treated from sulfate and calcination provided a significant result of showing its high capacity in absorbing E. coli with gentamicin-resistance gene. Furthermore, the study stated that its optimal

absorption from eggshells led to the increase of pathogenic bacteria, which shows great purification efficiency.

Biogas production is a good renewable energy source which requires various materials as a biogas source. Kivuyo et. al (2017) studied that pre-treating substrates, such as banana pulp, with calcined eggshells exhibit an efficient degradation of lignocellulosic substrate. The calcium carbonate content of eggshells allows the improvement of biogas yield as it assists in hydrolysis. Furthermore, a higher efficiency in converted organic compounds was achieved which led to the increase in pH and methane content.

According to the study conducted by Salaudeen et al. (2018), calcined eggshells can act as a potential CO₂ sorbent involved in biomass gasification. The increase in carbonation temperature improves the carbonation conversion. The gathered data from the study shows that around 76.41% of conversion was reached in the first calcination-carbonation cycle. However, due to the sintering and attrition, the conversion reduced with increasing cycles.

4. CONCLUSIONS

Due to the continuous increase of eggshell waste production, methods to repurpose these wastes must be implemented to minimize its contribution to filling up landfills. Eggshells reveal the potential of becoming a useful material for various processes because of their composition and morphology. For calcined eggshells, the thermal treatment process further increases their functional capacity. Thermal treatment parameters such as time and temperature also influence the performance of eggshells. After the collation of papers, the application of eggshell was grouped into seven general utilizations: catalyst, adsorption, additive, hydroxyapatite synthesis, bacteria removal, biogas production, and biomass gasification. Chicken eggshells were found to be the most used eggshell type in papers that specified the eggshell type used due to their abundance. Meanwhile, the data showed that the usual temperature and time for the calculation of eggshells ranges from 500-1000°C and about 2-4 hrs. Overall, the performance of eggshells for various applications indicate optimum efficiency as it ranges from 50-99.5%.

5. REFERENCES

Abdulrahman, I., Tijani, H., Mohammed, B., Saidu, H., Yusuf, H., Jibrin, M., & Mohammed, S. (2014). From garbage to biomaterials: an overview on eggshell based hydroxyapatite. *Journal of*



- Materials, 1-6.
<https://doi.org/10.1155/2014/802467>
- Agbabiaka, O., Oladele, I., Akinwekomi, A., & Adediran, A. (2020). Effect of calcination temperature on hydroxyapatite developed from waste poultry eggshell. *Scientific African*, 8. <https://doi.org/10.1016/j.sciaf.2020.e00452>
- Ahmadzadeh-Hakimi, K., Keshmirizadeh, E., & Modarress, H. (2017). The activation of eggshell by chemical and thermal treatment for removal of acid blue 92 dye from aqueous solutions. *Analytical Chemistry Letters*, 7(3), 369-382. <https://doi.org/10.1080/22297928.2017.1322535>
- Awogbemi, O., Inambao, F., & Onuh, E. (2020). Modification and characterization of chicken eggshell for possible catalytic applications. *Heliyon*, 6(10). <https://doi.org/10.1016/j.heliyon.2020.e05283>
- Hincke, M., Nys, Y., Gautron, J., Mann, K., Rodriguez-Navarro, A., & McKee, M. (2012). The eggshell: structure, composition, and mineralization. *Frontiers in Bioscience*, 17, 1266-1280. https://www.researchgate.net/publication/269791417_The_eggshell_structure_composition_and_mineralization
- Hunton, P. (2005). Research on eggshell structure and quality: An historical overview. *Brazilian Journal of Poultry Science*, 7(2), 61-71. <https://doi.org/10.1590/S1516-635X2005000200001>
- Kivuyo, L., Njau, K., & King'onde, C. (2017). Eggshells – assisted hydrolysis of banana pulp for biogas production. *African Journal of Environmental Science and Technology*, 11(1), 71. https://www.researchgate.net/publication/315633769_Eggshells_assisted_hydrolysis_of_banana_pulp_for_biogas_production
- Mohadi, R., Anggraini, K., Riyanti, F., & Lesbani, A. (2016). Preparation calcium oxide from chicken eggshells. *Sriwijaya Journal of Environment*, 1(2), 32-35. <https://doi.org/10.22135/sje.2016.1.2.32-35>
- Oladele, I., Agbabiaka, O., Adediran, A., Akinwekomi, A., Balohun, A. (2019). Structural performance of poultry eggshell derived hydroxyapatite based high density polyethylene bio-composites. *Heliyon*, 5(10), 1-7. <https://doi.org/10.1016/j.heliyon.2019.e02552>
- Salaudeen, S., Tasnim, S., Heidari, M., Acharya, B., & Dutta, A. (2018). Eggshell as a potential CO₂ sorbent in the calcium looping gasification of biomass. *Waste Management*, 80, 274-284. <https://doi.org/10.1016/j.wasman.2018.09.027>
- Ummartyotin, S. & Tangnorawich, B. (2015). Utilization of eggshell waste as raw material for synthesis of hydroxyapatite. *Colloid and Polymer Science*, 293, 2477-2483. <https://link.springer.com/article/10.1007/s00396-015-3646-0>
- United States Department of Agriculture. (2020, March). Philippine Broiler Market Trends and Prospects. <https://www.fas.usda.gov/data/philippines-philippine-broiler-market-trends-and-prospects>
- Wu, S., Hsu, H., Hsu, S., Chang, Y., & Ho, W. (2015). Effects of heat treatment on the synthesis of hydroxyapatite from eggshell powders. *Ceramics International*, 41(9). <https://doi.org/10.1016/j.ceramint.2015.05.006>
- Ye, M., Sun, M., Chen, X., Feng, Y., Wan, J., Liu, K., Tian, D., Liu, M., Wu, J., Schwab, A., & Jiang, X. (2017). Feasibility of sulfate-calcined eggshells for removing pathogenic bacteria and antibiotic resistance genes from landfill leachates. *Waste Management*, 63, 275-283. <https://doi.org/10.1016/j.wasman.2017.03.005>



Effect of Different Amounts of Volcanic Ash from the Taal Volcano Eruption to the Growth of *Ocimum basilicum* (Basil)

Rance Gershon B. Ferma, Roberto Miguel T. Pineda, Pierre Aaron M. Remigio,
and Jean Yuliong C. Tan

De La Salle University Integrated School, Biñan City, Laguna

Abstract: Volcanic eruptions have a tremendous impact on an area that often leads to the destruction of the environment, human injuries, and even death. However, this research emphasizes one specific outcome unique to volcanic eruptions. The study aims to shed light upon the beneficial applications of volcanic ash to determine whether or not volcanic ash has advantageous botanical properties that could potentially enhance the growth of *Ocimum basilicum* (basil). In 8 weeks, four different concentrations (VA-0, VA-0.5, VA-1, and VA-2) of volcanic ash-loam soil composition were tested on basil plants. Three parameters were utilized to measure the plant's growth: plant height, leaf count, and leaf surface area. Pot VA-1 achieved the highest plant height and leaf count increase among the four concentrations. As for the leaf surface area, VA-1 and VA-2 both yielded the highest growth from week 1 to week 8. Results support a beneficial relationship between volcanic ash and acid-loving plants.

Key Words: volcanic ash; basil; concentration; growth; acid-loving plants

1. INTRODUCTION

Every so often, volcanic activity occurs. Mt. Pinatubo, known for its global scale effect, has affected and devastated thousands of humans and other species, such as plants. Volcanic eruptions have a tremendous impact on an area that often leads to the destruction of the environment, human injuries, and even death. However, this research emphasizes one specific outcome unique to volcanic eruptions. Ash clouds will cover the atmosphere, leading to an abundant amount of volcanic ash everywhere when a volcanic eruption occurs. Depending on the magnitude of the explosion, its range or eruption radius may vary drastically. However, volcanic ash is commonly depicted as a terrible substance for the environment. Since it is heavy and acts as a sun-resistant layer over plants, it strongly hinders photosynthetic activities and transpiration from commencing.

In the field of botany, ash could potentially have effects that could change the way people grow plants and vegetables. With a composition of high sulfur levels, integrating ash into the soil could prove beneficial to acid-loving plants. According to the Natural Resources Conservation Service (NRCS), acid-loving plants prefer pH soil levels of 6.5 and below. Due to the ash's elevated sulfur levels and low pH levels, non-acidic plants may not survive. In contrast, acid-loving plants may thrive from their low pH nature. Acid-loving fruits grow more efficiently on soils with a pH level of 4.0 to 5.0. In contrast, some acid-loving vegetables will prefer a pH soil level of 4.5 to 5.5. In addition to this, soils following a volcanic eruption yield the most fertile and productive soil

(Fiantis et al., 2019). Individual plants grown in such soils could thrive and develop into healthy, high-yield plants.

Along with a volcanic eruption comes the adverse effects such as the destruction of acres of land, bodies of water engulfed by ash, thousands of crops perishing, and hundreds of homes rendered uninhabitable, to name a few. The aftermath of such events led to stockpiles of ash left on the streets. The problem is that all that ash was rendered useless by disposing of it rather than looking for ways to make use of its unique composition. As of today, volcanic ash is an excellent material for the structural integrity of bricks compared to cement usage (Salamah & Maryudi, 2016). Volcanic ash could potentially open many doors to new developments in different areas. With the utilization of the excess volcanic ash, the growth of acid-loving plants could improve. As studies have shown, the composition of volcanic ash leads to its high acidic nature. This brings the research to its hypothesis: volcanic ash aids in making the soil acidic to benefit the growth of acidic-loving plants.

The primary goal of the study is to undergo a substantial experimentation process to prove that unfiltered volcanic ash has botanic advantages. This study focused on plant development through natural means; hypothesized results could pave the way for future researchers to perform their trials with variables unique to their experiment. To achieve the projected outcome of this research, the researchers' general objective in conducting this study is to determine the effect of utilizing volcanic ash on basil's growth.

The findings of the study can be used as supporting evidence towards volcanic ash's overall knowledge, a resource regarded as pollution. This will be benefiting the agricultural sector as this could be used as an excellent addition to loam soil when growing acid-loving plants. This innovative, costless, and inventive soil composition with volcanic ash could drastically reduce the expenses of those looking to grow acidic-loving plants when choosing an efficient soil composition. Furthermore, this provides a framework for further studies regarding volcanic ash's feasibility as soil, making this particular soil composition evidence-based. If the research is successful, the addition of volcanic ash will prove an effective way to maximize available resources, making volcanic ash a more sought-after product when growing acid-loving plants. The effects of the volcanic ash from the Taal Volcano eruption are to be tested. However, because of the method of gathering the volcanic ash, it may not be considered pure. The height difference was determined using an initial and final measurement for each setup containing different volcanic ash concentrations. It could signify a change in development in the plant. The researchers only used four different concentrations of volcanic ash which includes a blank setup that serves as the control (0% volcanic ash), a 25% volcanic ash concentration composition, a 50% volcanic ash concentration composition, and a pure (100%) volcanic ash composition. Each of the concentrations yielded a certain pH level that was attained through averaging all the readings from time 0 to week 8. The pH levels are the following: 8.0 for VA-0, 6.5 for VA-0.5, 6.1 for VA-1, and 6.0 for VA-2. To ensure a pure reaction between the loam-volcanic ash soil composition, the researchers chose to avoid using chemicals such as aftermarket fertilizers and pesticides.

2. METHODOLOGY

Table 1. Materials Used

Qty.	Item	Description	Price (P)
16	Pot	16 identical pots measuring D:11in, H:9in.	P960
16	Basil seedlings	X weeks old seedlings	P1,120
14 kg	Volcanic ash	Volcanic ash was harvested during the Taal eruption and different amounts (g) will be used in 2/4 setups.	P0
80 kg	Loam	Each member gets 10 kg of loam. Loam will be used because it is the most basic form of garden soil	P560
4	Jollic pH indicator	Each member will receive identical pH level indicators for measurement of soil acidity with their respective trials.	P976
1	Escali gram scale Model: Pana#V136	To be used for mass concentration calculations to be done by one member.	P0
4	Anti-pest plant netting	To minimize or eradicate pest infestations, net usage will protect the plant.	P766
4	Ruler	To measure the growth height of the plant in centimeters	P0
Total:			P4,382

The research design formulates three different parameters that manifest plant growth. With the gathered data from 8 weeks of experimentation, each trial in each parameter has changed between the initial and the preceding week. The increasing parameters may help the amount of sunlight the plants receive hence providing more glucose or food for the plant to grow. Each pot gaining varying results on different parameters shows that each parameter benefits from the volcanic ash concentration.

There are sixteen pots in total. Since there are four members in the group, each member received and tended to 4 pots throughout the experimentation period. The pot was filled up to a certain point with the soil used (loam) to determine how much soil the pot can hold in grams, and once filled, the soil's weight was recorded. Each pot contained a different volcanic ash and soil concentration, while similar basil plants were planted in each pot. To meet the optimal pH level that basil thrives in (5.5-6.5 pH), every member of the research group was tasked to measure the loam soil's pH level in all of the assigned pots, respectively. Weight per weight percentage allowed the researchers to express the concentration of the solution. As for how the measurements were taken for the three parameters, namely plant height, leaf count, and leaf surface area, tools such as a ruler and ImageJ software were utilized to gather the data needed over eight weeks effectively. However, only the plant height and leaf count were recorded for eight consecutive weeks. The data taken for the leaf surface area was only an initial and final measurement, time zero and week eight, respectively.

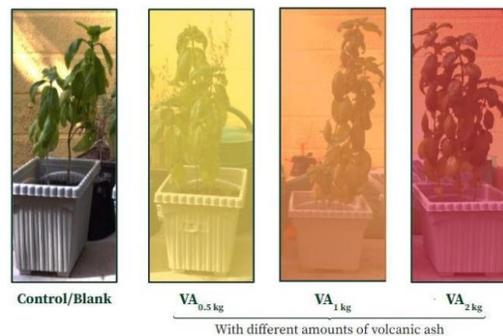

Figure 1. Research Design Showing Three Different Parameters per Trial

3. RESULTS AND DISCUSSION

As the researchers observed, the plant height had an average increase of 2 cm per week for VA-0, 1.9 cm per week for VA-0.5, 2.8 cm per week for VA-1, and 2.5 cm per week for VA-2. The average increase of the height of the plant was taken through finding the slope yielded by the trendline of each graph (Fig. 3.0-3.3). From this data that the members have gathered,



it can be concluded that VA-1 has the highest average increase which is 2.8cm per week. For leaf count (Fig. 5), it is shown in the graph that VA-0 has a continuous increase of leaves as weeks pass by. For VA-0.5 it reached its peak on week 5 and plateaued shortly after. VA-1 had a constant number of leaves within week 2 to week 5 and showed a sudden significant increase in number of leaves. Throughout eight weeks, the number of leaves of VA-2 shows an inconsistent increase and decrease in the number of leaves. The researchers took pictures of the basil leaves and used ImageJ to measure, analyze, and process the images to gain more accurate results. With this application, we were able to measure the area and compare the initial leaf area to week 8 area to know how much it has increased and to determine which pot has the highest area value. Starting from the pot which has the lowest average surface leaf area, VA-0.5 with 13.76 cm², VA-0 with 17.95 cm², VA-2 with an area of 22.71 cm², and the pot with the highest leaf area, was VA-1 with an area of 24.93 cm².

3.1 Plant Height

For the first week, there was a sudden increase in height for all trials with a ΔT range of 6-8 cm. It was hypothesized that the sudden increase might be natural plant growth since the initial height (time 0) was based on seedlings, or newly germinated seeds. Pot VA-1 averaged 2.8 cm of growth per week. Being the highest out of all four concentrations, pot VA-2 came in second with an average growth per week of 2.5 cm. The experimentation period ended at week 8 with pot VA-1 being the tallest plant with an average height of 31.7 cm; which may prove the presence of a snowball effect on the height of the basil. The second tallest plant is VA-2; which could prove that a more concentrated amount of volcanic ash is potentially beneficial to the height of acidic plants. Adding to this, pot VA-0.5 resulted in having the lowest height with a total average height of 23.7 cm.

Table 3.3. Summary table of plant height

No	Sample	Linear Equation	R ²	Growth Rate
1	VA-0	$y = 2.0050x + 11.496$	0.6120	2.0050
2	VA-0.5	$y = 1.9877x + 10.108$	0.6488	1.9877
3	VA-1	$y = 2.8562x + 10.302$	0.9113	2.8562
4	VA-2	$y = 02.5825x + 9.9958$	0.9477	2.5825

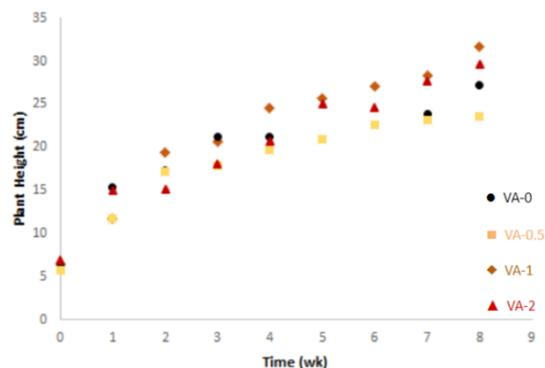
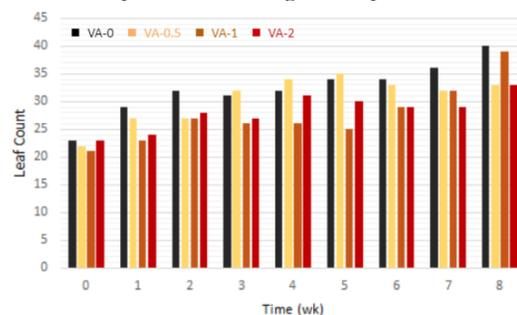

Figure 4.0. Combined Height of Basil Plants in a Span of Eight Weeks

3.2 Leaf Count

The basis behind including basil leaf count in the parameters is the concept of “more leaves means more sites for glucose production”. The pot that ended with the highest leaf count is VA-0 ; which had 40 leaves in average of all three trials. From week 0 to week 8, there was an increase of 17 leaves. The second plant with the highest leaf count is VA-1. It had 39 leaves in average of all three trials and had an increase of ~18 leaves from week 0 to week 8. Though VA-0 ended with the highest number of leaves, it had a lower increase of leaves from initial to final as compared to VA-1. As observed, VA-1 has the highest increase of leaf count with 18 leaves, with VA-0 being second to that. The researchers hypothesized that since VA-1 is the tallest, its height had an effect on the number of leaves increased since a higher plant height equates to more exposure to sunlight. This proves that leaf count is directly related to the plant height or the amount of exposure to sunlight the plant receives.



3.3 Leaf Surface Area

Similar to the leaf count, the size of the leaf plays a role in how much glucose could actually be produced by the plant; for the main goal of this research was to prove volcanic ash’s positive effects on basil’s growth. At time 0, VA-1 had the highest initial leaf surface area. It was able to maintain its lead ending with a highest final leaf surface area of 24.932 cm². VA-1 also had the highest change in leaf surface



area out of all the pots. There is a small difference between the increase in surface area from week 0 to week 8 of VA-1 and VA-2 with both numbers rounding up to 16.5 cm². With this, we are able to say that a higher concentration of volcanic ash in the soil composition will lead to a high leaf surface area increase as compared to VA-0 and VA-0.5.

4. CONCLUSIONS

This research had the aim to shed light upon the beneficial applications of volcanic ash; which is determining whether or not volcanic ash has advantageous botanical properties that could potentially enhance the growth of *Ocimum basilicum* (basil). VA-1 benefitted the most from its concentration in terms of growth, the highest slope in leaf count increase, the highest plant height, and the biggest leaf surface area. With this, having a pH level of 6.1, VA-1 yields the best overall results. The results of this study indicate a positive relationship between a volcanic ash soil composition and the growth of acidic-loving plants. Specifically, 1kg of volcanic ash in loam soil has the biggest effect on the growth rate of *Ocimum basilicum* (Basil). Further studies can make use of different acidic-loving plants. This gives the research more space to justify the benefits of a volcanic ash composition on acidic-loving plants. Furthermore, a particular location to experiment in will benefit the results by providing uniform treatment to the plants. The gathering of ash could also be improved to achieve accurate conclusions about the correlation between acid-loving plants and the effects of volcanic ash.

5. ACKNOWLEDGMENTS

We would like to express our gratitude to our research mentors Sir Errol Bantayan (Grade 11) and Ms. Leah Madrazo (Grade 12) for helping us bring our mere ideas into fruition. Through the topics discussed in class, the group was able to successfully translate what we had in mind into a comprehensive research paper. Along with this, much of our gratitude goes to the parents of the research group as they supported our research and aided in the acquisition of the materials considering the strict safety protocols brought by COVID-19. Finally, we would also like to thank our research adviser, Dr. Kerry Cabral, for putting up with the group and continuing to selflessly provide his time, tips, and guidance despite the group's numerous shortcomings.

6. REFERENCES

Albert, S. (2019). How to plant, grow, and harvest basil. Harvest to Table. https://harvesttotable.com/how_to_grow_basil/

Al-Maskari, M.Y. & Hanif, Muhammad Asif & Al-Maskari, A.Y. & AlAdawi, Samir. (2012). Basil: A natural source of antioxidants and nutraceuticals.

Bilal, A. & Jahan, Nasreen & MAKBUL, SHAIKH & Bilal, S.N. & Habib, S. & Hajra, S.. (2012). Phytochemical and pharmacological studies on *Ocimum basilicum*. *Int J Curr Res Rev.* 4. 73-83.

Cash, Philip & Stanković, Tino & Štorga, Mario. (2016). An Introduction to Experimental Design Research. 10.1007/978-3-319-33781-4_1.

Dorel, M., Roger-Estrade, J., Manichon, H., & Delvaux, B. (2006). Porosity and soil water properties of Caribbean volcanic ash soils. *Soil Use and Management*, 16(2), 133–140. doi:10.1111/j.1475-2743.2000.tb00188.x

Fiantis, Dian & Ginting, Frisa & Gusnidar, & Nelson, M. & Minasny, Budiman. (2019). Volcanic Ash, Insecurity for the People but Securing Fertile Soil for the Future. *Sustainability*. 11. 3072. 10.3390/su11113072.

Grosshans, R., Viswanathan, B., Gass, P., & Grieger, L. (2019). Sustainable Watersheds for Carbon Offsets: Biomass harvesting for phosphorus capture, habitat renewal and carbon emissions reductions (pp. 14-16, Rep.). International Institute for Sustainable Development (IISD). doi:10.2307/resrep22001.6

Hamasaki, Randall & Valenzuela, Hector & Tsuda, Dick & Uchida, Janice. (1994). Fresh Basil Production Guidelines for Hawai'i.

Hossain, K.. (2006). High strength blended cement concrete incorporating volcanic ash: Performance at high temperatures. *Cement and Concrete Composites*. 28. 535-545. 10.1016/j.cemconcomp.2006.01.013.

J. Michael Geist. (1976). Orchardgrass Growth on Nitrogen and Sulfur Fertilized Volcanic Ash Soil. *Journal of Range Management*, 29(5), 415-418. doi:10.2307/3897155

Kogge, Kome & Kogge, Enang & Yerima, Bernard & Gille Raoul, Lontsi. (2018). Models relating soil pH measurements in H₂O, KCl and CaCl₂ for volcanic ash soils of



- Cameroon. *Geoderma Regional*. 14. e00185. 10.1016/j.geoder.2018.e00185.
- Kokkini, Stella & Karousou, Regina & HANLIDOU, Effie. (2003). *HERBS | Herbs of the Labiatae*. 10.1016/B0-12-227055-X/00593-9.
- Lansing, John & Kremer, James & Pollard (Gerhart), Vanda & Kremer, Patricia & Arthawiguna, Alit & Surata, Sang & Suprpto, & Suryawan, Ida & Arsana, I. & Scarborough, Vernon. (2001). Volcanic fertilization of Balinese rice paddies. *Ecological Economics*. 38. 383-390. 10.1016/S0921-8009(01)00173-2.
- McCauley, A., Jones, C., & Olson-Rutz, K. (March 2017). Soil PH and Organic Matter, 1-16.
- Makri, Olga & Kintzios, Spiridon. (2008). *Ocimum sp. (Basil): Botany, Cultivation, Pharmaceutical Properties, and Biotechnology*. *Journal of Herbs, Spices & Medicinal Plants*. 13. 123-150. 10.1300/J044v13n03_10.
- Moles, Angela & Warton, David & Warman, Laura & Swenson, Nathan & Laffan, Shawn & Zanne, Amy & Pitman, Andy & Hemmings, Frank & Leishman, Michelle. (2009). Global patterns in plant height. *Journal of Ecology*. 97. 923 - 932. 10.1111/j.1365-2745.2009.01526.x.
- Nakagawa, Mitsuhiro & Ohba, Tsukasa. (2002). *Minerals in Volcanic Ash 1: Primary Minerals and Volcanic Glass*. 6.
- Nanzyo, Masami. (2002). Unique properties of volcanic ash soils. *Glob. Environ. Res.*. 6.
- Salamah, Siti & Maryudi, Maryudi. (2016). Utilization of Kelut's Volcanic Ash as the Aggregate Mixture of Concrete Brick. *Key Engineering Materials*. 718. 196-200. 10.4028/www.scientific.net/KEM.718.196.
- Singletary, Keith. (2018). Basil: A Brief Summary of Potential Health Benefits. *Nutrition Today*. 53. 92-97. 10.1097/NT.0000000000000267.
- Shoji, Sadao & Takahashi, Tadashi. (2002). Environmental and agricultural significance of volcanic ash soils. *Global Environmental Research*. 6.
- Shoji, S., Nanzyo, M., & Dahlgren, R. (2006). *Volcanic ash soils: genesis, properties, and utilization*. Amsterdam: Elsevier.
- Soti, P., Jayachandran, K., Koptur, S., & Volin, J. (2015). Effect of soil pH on growth, nutrient uptake, and mycorrhizal colonization in exotic invasive *Lygodium microphyllum*. *Plant Ecology*, 216(7), 989-998. Retrieved April 10, 2020, from www.jstor.org/stable/24557827
- Tsuyuzaki, S., & Del Moral, R. (1995). Species Attributes in Early Primary Succession on Volcanoes. *Journal of Vegetation Science*, 6(4), 517-522. Retrieved April 30, 2020, from www.jstor.org/stable/3236350
- Ugolini, Fiorenzo & Dahlgren, Randy. (2002). Soil development in volcanic ash. *Global Environ. Res. Engl. Ed.*. 6.



On the Effects of N-P-K Fertilizer to the Electricity Generated by *Aloe barbadensis miller*

Adelaide Louise M. Naquila, Cher Rylie C. Matoza, Cholo V. Aguilar, Erynne C. Ayuson, Beatriz, Ysabelle C. Escalona, Carl Arian Miguel G. Ganzon, Jose Miguel Q. Mahalin, Natalia F. San Pedro, Ailyn B. Anglo-Ojeda, and Fritz M. Ferran
De La Salle Santiago Zobel School - Vermosa Campus, Imus City, Cavite

Abstract: Nowadays, electricity is a pressing conflict due to the increase in demand by the populace. Thus, energy prices have also increased, making it considerably inaccessible to several population members. Considering this, the researchers have studied the type of N-P-K fertilizer that can improve the efficiency of producing electricity from a living plant. There were four experimental setups of *Aloe barbadensis miller* that were utilized in the experiment. Every variable and component of each setup was constant, except the type of fertilizer that was added to the soil. The first setup did not have any fertilizer, the second group had Nitrogen-based (N-P-K 21:0:0), the third group had Phosphorus-based (N-P-K 0:22:0), and the fourth group had Potassium-based (N-P-K 0:0:50). The researchers gathered data on electricity generated in the *Aloe vera* derived from a capacitor using a multimeter every 12 hours for 16 days. Descriptive statistics and repeated measures of ANOVA statistical tests were utilized to perform the data analysis. Results showed that the setup with potassium-based fertilizer had produced significantly greater electricity ($p < .05$) among the four setups whose differences were insignificant ($p > .05$). Time had a moderate but negligible effect on the electricity produced by the *Aloe vera*. It is advised to increase the time taken to observe the plant if further research will be done on the topic.

Key Words: aloe vera; electricity generation; nitrogen-based fertilizer; phosphorus-based fertilizer; potassium-based fertilizer

1. INTRODUCTION

Electricity has become an integral part of human life in the modern era. It affects one's capability of acquiring education, communicating with others, and cooking food without destroying the ecosystem (Löfquist, 2020). In the Philippines, electricity has become a necessity in every household due to the importance of electrical appliances as assets to most of the population (Reyes et al., 2012). Yet, over 2.3 million homes in the Philippines still lack access to electricity (National Electrification Administration, 2019), and 59 million people in the country have no access to clean cooking (Renewable Energy Policy Network for the 21st Century, 2020).

Considering the insufficient electricity supply, previous research utilized accessible natural resources, such as plants, to create potential energy sources. Ying and Dayou (2016) found that plants can generate electricity by transmuting sunlight into electricity based on photosynthesis. The study shows the conversion of chemical energy to electrical energy by embedding a pair of electrodes into the plant's leaves. Bundschuh, Yusaf, Maity, Nelson, Mamat, and Mahlia (2014) studied the capability of algae-biomass being used as fuel for electricity and agriculture. This

source was expected to provide a new power generation system for the low-power electrical equipment used in forestry. However, the voltage was weak which caused great difficulty in the application. Despite these previous studies concerning generating sustainable energy, they have only been able to generate sustainable energy with low voltage.

The objective of this study is to create sustainable energy from organic life and to produce an adequate amount of electricity. Previous studies have shown that generating sustainable energy from living plants is possible; however, it cannot naturally produce an adequate amount of electricity that can be used instantaneously (Bundschuh et al., 2014). Thus, the researchers of this study will examine which of the different N-P-K fertilizers will improve the efficiency of energy production of the plant.

2. Literature Review



Figure 1. Conceptual Framework of the Study

Figure 1 presents the possibility of how the different N-P-K fertilizers may directly affect the electricity generated by the *Aloe vera* plant. It is known that the primary nutrients of the fertilizer – Nitrogen, Phosphorus, and Potassium – directly influence the plant's process of photosynthesis (Bolfarini et al., 2016; Gierth & Mäser, 2007). Since ATP, the energy of the plant, is produced in the photosynthesis process, the N-P-K can possibly have a significant effect on the electricity produced by plants. This study aims to see whether plants can produce enough electricity when N-P-K fertilizer is added to their soil.

Specifically, the study aims to answer the following:

- a. What is the electricity produced by the *Aloe vera* plants after introducing the N-P-K fertilizers for 16 days?
- b. Is there a significant difference in the electricity produced by the *Aloe vera* plant with different N-P-K fertilizers observed in a 48-hour interval for 16 days?

2. METHODOLOGY

2.1. Research Design

The experimental research design was suitable for this study since it required experimentation on the electricity produced by plants in response to the added N-P-K fertilizers with varied ratios of Nitrogen, Phosphorus, and Potassium.

3.2. Data Gathering Procedures

Before data gathering, the researchers accomplished a Research Ethics Checklist and letter of approval. Once approved, they began with the acquisition of materials sourced from online stores. In this experiment, the four *Aloe vera* samples, sourced from a mother plant from a farm, were divided into four experimental setups. The first setup, the control group, was treated with no fertilizer. For the second, Nitrogen-based fertilizer (N-P-K 21:0:0) was treated to the plant. For the third, Phosphorus-based fertilizer (N-P-K 0:22:0) was added. Lastly, the fourth setup was treated with Potassium-based fertilizer (N-P-K 0:0:50).



Figure 2. Experimental setups (from left to right: Nitrogen-based, Potassium-based, Phosphorus-based, No fertilizer)

As shown in Figure 2, each setup had six pairs of Zinc (Zn) anode and Copper (Cu) cathode embedded on two leaves of the *Aloe vera* plant (Chong et al., 2019). A 4.7 uF 400V Aluminum Electrolytic capacitor was connected to store the electricity generated by the plants. A digital multimeter was used to measure the voltage stored in the capacitor. It was set to have a maximum measurement of 2.000 Volts.

Upon completing the experimental setups, the researchers began recording the electricity generated by each experimental design using the digital multimeter connected to the capacitor. The recording of observations occurred every 12 hours within 16 days. Throughout the experimentation, the plants were watered regularly and were exposed to sunlight to maintain its prime condition.

After obtaining all needed observations, the researchers began to organize their raw data in preparation for the data analysis.

3. RESULTS AND DISCUSSION

Two primary data analysis procedures were performed using IBM SPSS version 24. The first is Descriptive statistics (Mean and Standard Deviation), which was used to find the average electricity produced by the sample per setup. The second is repeated measures of Analysis of Variance, which was used to determine if there is a significant difference between the setups as time passes.

3.1. What is the electricity produced by the *Aloe vera* plants after introducing the N-P-K fertilizers for 16 days?

Table 1. Descriptive Statistics of Electricity Produced by *Aloe vera* plants treated with different N-P-K fertilizers

Time	N	No Fertilizer		Nitrogen-based		Phosphorous-based		Potassium-based	
		M	SD	M	SD	M	SD	M	SD
1	4	1.266	.596	1.383	.082	1.393	.585	1.092	.503
2	4	1.076	.485	1.302	.352	1.447	.168	1.234	.156
3	4	1.456	.143	1.016	.671	1.523	.346	1.614	.13
4	4	1.555	.052	1.353	.211	1.227	.087	1.622	.081
5	4	1.079	.107	1.253	.02	1.009	.065	1.512	.099
6	4	1.052	.067	1.369	.121	1.033	.025	1.39	.062
7	4	1.412	.148	1.422	.185	1.237	.145	1.476	.097
8	4	1.148	.034	1.198	.07	1.171	.063	1.387	.078

Table 1 presents the electricity generated by the *Aloe vera* plants treated with different N-P-K



fertilizers observed in a 48-hour time interval. A total of 128 valid cases were examined with an equal number of recorded observations per N-P-K fertilizer type (4).

The visualization of the differences in the electricity produced in each setup is shown below:

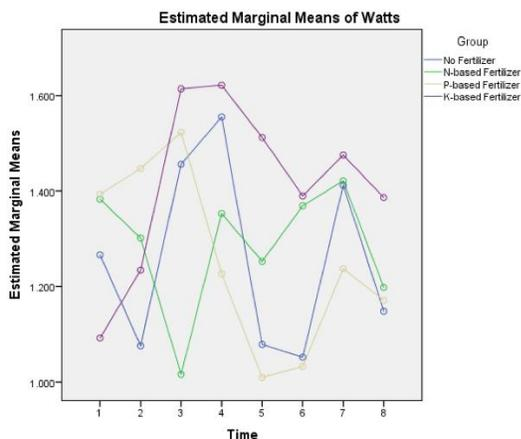

Figure 3. Means Plot of Estimated Marginal Means of Watts

As shown in Figure 3, the electricity produced by the majority of fertilizer groups tended to hit their peaks between and around the end of the second and third intervals, with the outlier being the nitrogen-based fertilizer hitting the rise between the sixth and seventh-time interval. A previous study concluded that organic sources of fertilizer helped improve the quality of the Aloe vera (Saha et al., 2003). This shows that by improving the quality of the plants with fertilizer, the generated electricity by the plant increased.

The P-based fertilizer setup produced the most electricity throughout the first and second-time intervals with a continuous rise in electricity production. Phosphorus contributes largely to plant product yield in agriculture since it influences the plant's ability to utilize water in its system and other micronutrients in the plant's soil (Valkama et al., 2009). However, it also decreases the Nitrate stored in the plant (Wang & Li, 2004). With this, the plant is likely to have been influenced by having more nutrients and water to utilize.

The K-based fertilizer setup produced the most electricity among the four setups during the third-time interval and onwards. Potassium in plants increases the rate at which the plant with damage repairs itself and maintains the ionic homeostasis (Wang et al., 2013). The nature of the experiment setup made the K-based fertilizer's role more significant since the plants became weak to hold the

copper and zinc plates for as long as they had. Additionally, the level of K in the soil could influence the plant's uptake of N-P-K elements in the ground (Baque et al., 2006).

5.2. Is there a significant difference in the electricity produced by the Aloe vera plant with different N-P-K fertilizers observed in a 48-hour interval for 16 days?

The analysis of the results generated by the Repeated Measures of ANOVA is presented in two ways. The discussion of the assumptions is given first, then followed by the main outcome.

Table 2. Normality Test

	Kolmogorov-Smirnov ^a		
	Statistic	df	Sig.
t1	.172	16	.200 [*]
t2	.164	16	.200 [*]
t3	.179	16	.179
t4	.189	16	.129
t5	.155	16	.200 [*]
t6	.240	16	.014
t7	.079	16	.200 [*]
t8	.170	16	.200 [*]

^{*} This is a lower bound of the true significance.
^a Lilliefors Significance Correction

The normality test was performed using Kolmogorov-Smirnov, and Table 2 shows that the collected data for the seven observations are normal ($p > 0.05$) except during time 6 ($p = 0.014$).

Table 3. Mauchly's Test of Sphericity^a

Measure: Electricity Generated							
Within Subjects Effect	Mauchly's W	Approx. Chi-Square	df	Sig.	Epsilon ^b Greenhouse-Geisser	Huynh-Feldt	Lower-bound
Time	.000	88.714	27	.000	.137	.080	.143

Tests the null hypothesis that the error covariance matrix of the orthonormalized transformed dependent variables is proportional to an identity matrix.
^a Design: Intercept + Group
 Within Subjects Design: Time
^b May be used to adjust the degrees of freedom for the averaged tests of significance. Corrected tests are displayed in the Tests of Within-Subjects Effects table.

Sphericity is a condition where the variances between the differences between the related groups are equal. And since the Repeated Measures of ANOVA is susceptible to violating this assumption, Mauchly's Test of Sphericity was performed and shown in Table 3. Mauchly's Test of Sphericity indicated that the assumption of sphericity had been violated, $\chi^2(27) = 88.714$, $p < .0005$, and therefore, a Greenhouse-Geisser correction was used since $\epsilon < 0.75$.

Table 4. Tests of Within-Subjects Effects

Measure: Electricity Generated							
Source		Type III Sum of Squares	df	Mean Square	F	Sig.	Partial Eta Squared
Time	Sphericity	.956	7	1.366	1.895	.080	.136
	Assumed Greenhouse-Geisser	.956	2.666	.358	1.895	.156	.136
Time * Group	Sphericity	2.534	21	.121	1.675	.052	.295
	Assumed Greenhouse-Geisser	2.534	7.999	.317	1.675	.143	.295
Error (Time)	Sphericity	6.052	84	.072			
	Assumed Greenhouse-Geisser	6.052	31.995	.189			

Partial eta squared can be cited as a measure of effect size: f^2 is Cohen's effect size: .02 = small, .15 = moderate, .35 = large.



Also, there was no significant effect of time on the generated electricity by Aloe vera with different N-P-K fertilizers, $F(2.666, 31.995) = 1.895, p > 0.05$.

Table 4 presents that the use of fertilizer had a nearly moderate effect on the electricity generated by the Aloe vera over time (partial $\eta^2 = 0.136$); however, this is not significant $F(2.666, 31.995) = 1.895, p > 0.05$.

The significance of time to the affected electricity caused by the addition of different N-P-K fertilizers ratios is likely because the time of the experiment was too short. The total number of days taken to conduct the experiment in other related studies is greater compared to this. A study by Lazcano, Gómez-Brandón, Revilla, and Domínguez (2012) had three months of fertilizer exposure for the plant before data gathering, considered as 'short-term'. Another study by Valkama, Uusitalo, Ylivainio, Virkajärvi, and Turtola (2009) had up to twelve months of application of fertilizer. Another independent research by Saïdou, Janssen, and Temminghoff (2003) had three years to test the effects of the fertilizer on the plants. Based on these three studies, the time of experimentation was significantly shorter than the aforementioned studies.

Table 5. Tests of Between-Subject Effects

Measure: Electricity Generated						
Transformed Variable: Average						
Source	Type III Sum of Squares	df	Mean Square	F	Sig.	Partial Eta Squared
Intercept	217.408	1	217.408	5026.975	.000	.998
Group	.561	3	.187	4.326	.028	.520
Error	.519	12	.043			

Partial eta squared can be cited as a measure of effect size: f^2 is Cohen's effect size: .02 = small, .15 = moderate, .35 = large.

Table 5 presents that there is a significant difference in the electricity generated by Aloe vera when treated with different fertilizers, $F(2.666, 31.995) = 1.895, p < 0.05$. The effect of the differences in the fertilizers applied to the soil where the Aloe vera is planted is large (partial $\eta^2 = 0.520$).

Table 6. Multiple Comparisons

Measure: Electricity Generated						
LSD						
(I) Group	(J) Group	Mean Difference (I-J)	Std. Error	Sig.	Lower Bound	Upper Bound
No Fertilizer	N-based	-.03122	.051991	.559	-.14450	.08206
	Fertilizer P-based	.00053	.051991	.992	-.11275	.11381
	Fertilizer K-based	-.16025*	.051991	.009	-.27353	-.04697
	Fertilizer					
N-based Fertilizer	P-based	.03175	.051991	.553	-.08153	.14503
	Fertilizer K-based	-.12903*	.051991	.029	-.24231	-.01575
	Fertilizer					
P-based Fertilizer	K-based	-.16078*	.051991	.009	-.27406	-.04750

Based on observed means.
 The error term is Mean Square (Error) = .005.
 * The mean difference is significant at the .05 level.

Post-hoc Test using LSD was performed to determine which of the N-P-K fertilizers show a significant difference in the electricity generated by Aloe vera. As shown in Table 6, only the following different N-P-K fertilizers show a significant difference: No fertilizer and K-based fertilizer, N-based fertilizer and K-based fertilizer, P-based Fertilizer and K-based fertilizer, $p < .05$.

Previous studies have studied the effect of potassium on the plant. Grzebisz, Gransee, Szczepaniak, and Diatta (2013) experimented with the effects of potassium fertilization on water supplies and nitrogen to a plant during its critical stages of growth. The plant's access to potassium during mild water-deficiency stress stimulates water uptake through the root cells. This results in an extension of development, giving it access to various mineral elements such as nitrogen and water, which are essential for plant growth. Wang, Zheng, Shen, and Guo (2013) found that potassium (K) has several biological components that strengthen the plant's growth and metabolism. Lower K concentrations can further depress the plant resistance to drought stress and K absorption; this is due to its weakness in terms of water uptake. One of the advantages, as discussed in the study, is that it stimulates photosynthesis. It also regulates protein synthesis, enhances damage repair and water uptake, and maintains ionic homeostasis.

4. CONCLUSIONS

This study discovered the significant relationship of potassium to the electricity produced by the plant. Yet, the researchers cannot discern the effect that fertilizer would have on electricity throughout a specific period. Despite these findings, there are numerous limitations to this study. The data gathering period for the researchers was only limited to 16 days because of time constraints. Moreover, each experimental setup utilized only one Aloe vera sample. Hence, the results of the research may not have been precise.

Furthermore, other variables that may have affected the Aloe vera plant's electrical yield were not observed and manipulated. This includes the condition of the environment, weather, material of the electrodes, plant type, and soil type. The researchers recommend that the duration of experimentation be conducted for a more extended period. Studying fertilizers with other N-P-K ratios with more potassium content can provide more information on the specific type of fertilizer that could generate a significantly more tremendous amount of energy. Future studies may research other possible factors that may affect and improve the efficiency of electricity generation in plants.



5. ACKNOWLEDGMENTS

This study would not be written if it were not for the people who supported the researchers throughout the year. For that, the researchers would like to express their gratitude to the following people.

Sir Gerald Gamboa for allowing the researchers some of their time to consult them about the statistical treatment, the setup, and other concerns of this study.

Ms. Airah Valles for reviewing the writing conventions of the paper.

Sir Salvador John Magalong for allowing the researchers to consult him regarding the feasibility of the research project.

The families of the researchers for supervising the data gathering procedure and for their unconditional support.

6. REFERENCES

- Baque, M. A., Karim, M. A., Hamid, A., & Tetsushi, H. (2006). Effects of fertilizer potassium on growth, yield and nutrient uptake of wheat (*Triticum aestivum*) under water stress conditions. *South Pacific Studies*, 27(1), 25-35.
- Bolfarini, A. C. B., Leonel, S., Leonel, M., Tecchio, M. A., Silva, M. D. S., & Souza, J. M. A. (2016). Growth, yield and fruit quality of 'Maçã' banana under different rates of phosphorus fertilization. *Australian Journal of Crop Science*, 10(9), 1368-1374. doi: 10.21475/ajcs.2016.10.09.p7892.
- Bundschuh, J., Yusaf, T., Maity, J. P., Nelson, E., Mamat, R., & Mahlia, T. I. (2014). Algae-biomass for fuel, electricity and agriculture. *Energy*, 78, 1-3. doi: 10.1016/j.energy.2014.11.005.
- Chong, P.L., Singh, A.K., Kok, S.L. (2019) Characterization of Aloe Barbadensis Miller leaves as a potential electrical energy source with optimum experimental setup conditions. *PLOS ONE* 14(6): e0218758. <https://doi.org/10.1371/journal.pone.0218758>
- Gierth, M., & Mäser, P. (2007). Potassium transporters in plants - Involvement in K⁺ acquisition, redistribution and homeostasis. *FEBS Letters*, 581(12), 2348-2356. doi:10.1016/j.febslet.2007.03.035.
- Grzebisz, W., Gransee, A., Szczepaniak, W. and Diatta, J. (2013), The effects of potassium fertilization on water-use efficiency in crop plants. *Z. Pflanzenernähr. Bodenk.*, 176: 355-374. <https://doi.org/10.1002/jpln.201200287>.
- Lazcano, C., Gómez-Brandón, M., Revilla, P., & Domínguez, J. (2012). Short-term effects of organic and inorganic fertilizers on soil microbial community structure and function. *Biology and Fertility of Soils*, 49(6), 723-733. doi:10.1007/s00374-012-0761-7.
- NEA (2019). NEA'S 2020 PROPOSED BUDGET TO CONTINUE FUNDING ELECTRIFICATION PROJECTS. Retrieved from <https://www.nea.gov.ph/ao39/458-nea-s-2020-proposed-budget-to-continue-funding-electrification-projects-masongsong>.
- REN21 (2020). Renewables 2020 Global Status Report. REN21 Secretariat, Paris.
- Reyes, C. M., Tabuga, A. D., Asis, R. D., & Datu, M. B. G. (2012). Poverty and agriculture in the Philippines: Trends in income poverty and distribution. *PIDS DPS*, (2012-09).
- Saha, R., Palit, S., Ghosh, B. C., & Mitra, B. N. (2003). Performance of Aloe vera as influenced by organic and inorganic sources of fertilizer supplied through fertigation. In III WOCMAP Congress on Medicinal and Aromatic Plants- Volume 2: Conservation, Cultivation and Sustainable Use of Medicinal and 676 (pp. 171-175).
- Saidou, A., Janssen, B. ., & Temminghoff, E. J. . (2003). Effects of soil properties, mulch and NPK fertilizer on maize yields and nutrient budgets on ferralitic soils in southern Benin. *Agriculture, Ecosystems & Environment*, 100(2-3), 265-273. doi:10.1016/s0167-8809(03)00184-1.
- Valkama, E., Uusitalo, R., Ylivainio, K., Virkajärvi, P., & Turtola, E. (2009). Phosphorus fertilization: A meta-analysis of 80 years of research in Finland. *Agriculture, Ecosystems & Environment*, 130(3-4), 75-85. doi:10.1016/j.agee.2008.12.004.
- Wang, M., Zheng, Q., Shen, Q., & Guo, S. (2013). The Critical Role of Potassium in Plant Stress Response. *International Journal of Molecular Sciences*, 14(4), 7370-7390. doi:10.3390/ijms14047370.
- Wang, Z., & Li, S. (2004). Effects of Nitrogen and Phosphorus Fertilization on Plant Growth and Nitrate Accumulation in Vegetables. *Journal of Plant Nutrition*, 27(3), 539-556. doi:10.1081/pln-120028877.
- Ying, C. Y., & Dayou, J. (2016). Modelling of the electricity generation from living plants. *Jurnal Teknologi*, 78(6).



A Life Cycle Assessment of Disposable Medical Masks and its Impacts Towards the Environment in the Context of the COVID-19 Pandemic

Marielle A. Batungbacal and Paula Gabrielle Angelique C. Reyes
Assumption College San Lorenzo, Makati City

Abstract: This study is about the Life Cycle Assessment of Disposable Medical Masks and its Environmental Impacts in the context of the COVID-19 pandemic in the Philippines. Prior to the study, the researchers have noticed that there was an increase in demand for disposable medical masks as a response to the COVID-19 pandemic. The overall objective of the study was to assess the environmental impacts of the life cycle of disposable medical masks in the context of three variables which are energy consumption, waste production, and pollution. The impacts were assessed using related literature and gathered data from respective respondents through the dissemination of online questionnaires among 5 different focus groups. The results from the surveys have shown that the production of healthcare waste has doubled in the past year and is mainly composed of disposable medical masks. In addition, answers from the surveys have shown that the majority of households improperly dispose of their masks by not complying with the set guidelines of the Department of Health. After data collection and discussion, the researchers have observed the connections between the increase in demand for masks and the damaging of the environment in relation to the three variables. To conclude, the researchers have disproved the initial null hypothesis.

Key Words: life cycle assessment; disposable medical mask; environmental sustainability; Personal Protective Equipment; COVID-19

1. INTRODUCTION

1.1 Rationale

At the beginning of the pandemic, the world turned its focus to prioritizing safety and health that the state of the environment was neglected. With this, many environmental advocates and organizations have been bringing attention to the rise in energy consumption from the production and disposal of medical masks. In addition, a more pressing environmental concern was brought up due to the improper disposal of medical masks. After use, the mask cannot be recycled due to the risk of contamination therefore, it is needed to be disposed of (Parkinson, 2020). Without proper disposal, masks end up in landfills and even in the ocean causing damage to marine life and worsening the issue of general pollution (Kassam, 2020). The several issues brought up by these articles show the overall severity of the environmental situation caused by disposable medical masks.

1.2. Statement of the Problem

The study assessed the Life Cycle of Disposable Medical Masks and its Impacts towards the environment in the context of the COVID-19 pandemic.

Specifically, the research answered the following questions:

1. What is the Life Cycle of Disposable Medical Masks?
2. What are the proper and improper methods/processes in the disposal of medical masks?
3. What are the impacts of the production processes of disposable medical masks towards the environment?
 - a. Energy consumption
 - b. Production waste
4. What are the impacts of the disposal of disposable medical masks towards the environment?
 - a. Energy consumption
 - b. Waste production
 - c. Pollution

1.3. Hypothesis

The increasing rate of utilization of disposable medical masks has no significant impact towards the environment in the context of the COVID-19 pandemic.



2. METHODOLOGY

2.1. *Type of Research and Research Design*

A descriptive research design was chosen to show the analysis of the life cycle of the masks in determining its effects towards the environment. It was used to justify the presented realities which were obtained through the answered survey forms of the chosen respondents in relation to the LCA of disposable medical masks.

2.2. *Samples and Sampling Technique*

To select respondents for data collection in the LCI phase, the researchers have utilized a convenience sampling technique. This was used because of the lack of availability of the respective respondents given the ongoing COVID-19 pandemic. Each focus group consisted of a certain number of respondents, again, depending on the availability of respondents in the ongoing pandemic disregarding the factors of age and sex. The five focus groups were based on their profession and expertise in the main focus of this research: environmentalists, medical practitioners, waste management officers, mask consumers and mask distributors.

The first focus group consists of environmentalists required to have knowledge about key environmental issues such as waste pollution and overconsumption of energy. The second focus group consists of medical practitioners with a minimum of 5 years of experience serving in their medical field and knowledge about the coronavirus. The third focus group is composed of waste management officers with respective expertise on the presence of waste pollution and waste production, specifically in terms of PPE, perspectives, and data regarding PPE pollution and the environmental effects of the disposal process. The fourth focus group is composed of mask distributors willing to disclose information regarding their rates of supply and demand of sales with respect to the ongoing COVID-19 pandemic. Lastly, the fifth focus group was mask consumers utilizing disposable medical masks as a preventive measure from getting the virus; their questions were focused on their rate of consumption on a monthly basis and their disposal process after usage.

2.3. *Research Instrumentations*

The researchers utilized five different surveys wherein one was adapted from past studies to gather and collect data. The first survey was a five-item questionnaire given to environmentalists created by the researchers to gather information about effects caused by the life cycle of disposable medical masks from an environmental perspective. The second instrument given to medical practitioners

was a seven-item survey to understand the purpose and effectiveness of a mask in hindering the spread of the COVID-19 virus. The third instrument is a seven-item survey disseminated among mask sellers which focuses on the rate of sales of different types of masks in Metro Manila during the COVID-19 pandemic. The fourth instrument was a five-item survey focused on the consumption rate of masks and means of their disposal which is administered to mask consumers in Metro Manila. This survey was focused on their consumption rate of their preferred types of masks and their means of disposal after usage.

The last survey that was given to HCWM officers was an adapted and shortened version of the Health-Care Waste Management Rapid Assessment Tool. This was developed by the WHO, and its goal is to promote safe and appropriate practices in the field of HCWM ("Health-care waste management rapid assessment tool", 2016). Its purpose is to understand the processes and the overall situation regarding the HCWM system.

2.4. *Procedures*

Preparation of Adapted Survey Questionnaire
The researchers designed a survey fit to the specifications of the study which highlighted the given variables, and this was done specifically for the respondents under the category of medical practitioners and environmentalists. Aside from the designed surveys which have been disseminated to medical practitioners, environmentalists, mask distributors, and mask consumers, an adapted Health Care Waste Management (HCWM) assessment was utilized for the chosen Waste Management Officers. Afterward, a confidentiality conforme has been made for respondents to be assured of the compliance towards the Data Privacy Act of 2012, to be signed prior to answering the designed survey.

Administration of the test to the respondents

Firstly for the chosen available medical practitioners, environmentalists, mask distributors, mask consumers, and waste management officers, all were given a confidentiality conforme to answer prior the survey. Afterwards, questionnaires were administered to the respondents.

2.5 *Statistical Treatment*

The researchers made use of Descriptive Statistics as its statistical treatment in this study. It was used to thoroughly describe and indicate the manners on how the life cycle of disposable medical masks impact the environment, specifically in the context of the COVID-19 pandemic. Through the obtained data, the statistical analysis of this was focused on the evaluation of the answers of the respondents and used as one of the basis of the

conducted study.

3. RESULTS AND DISCUSSION

3.1 Problem 1

What is the life cycle of a disposable medical mask?

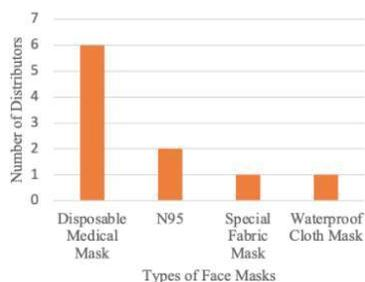

Figure 1. Types of Face Masks Sold

There are three main phases of the life cycle of disposable medical masks: production, usage, and disposal. The researchers decided to give focus to only the production and disposal phases. Within the production phase, there are four sub-processes that occur accordingly: (1) Acquisition of raw materials, (2) Transportation of materials, (3) Production line, (4) Distribution to the sellers. The generic type of surgical face masks that 85.7% of all respondents from the distributors' focus group sell are commonly made up of 3 non-woven layers (see figures 1 and 2) which all serve a purpose in providing the mask's filtration efficiency. These layers are produced in one of two procedures: spun bond or melt-blown (Chua et al, 2020).

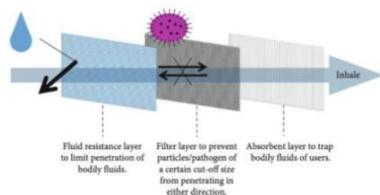

Figure 2. Layers of a Disposable Medical Mask (Chua et al., 2020)

In the disposal phase of the cycle, 6 sub-processes occur accordingly: (1) Initial segregation, (2) Storage, (3) Collection, (4) Transportation, (5) Treatment, (6) Final Disposal (DENR-EMB, 2020). The first process is the most crucial since it decides whether the HCW will undergo proper disposal or not. As seen in figure 3, results from the surveys showed that 71.4% of HCW are disposed of in the wrong waste container. The other 29.6% get stored and transported

by DENR certified transportation companies to treatment facilities.

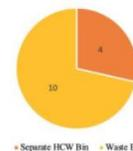

Figure 3. Disposable Methods of Medical Practitioners and Consumer

All the results and discussions done under this research problem can be consolidated into figure 4.1 and 4.2.



Figure 4.1. Life Cycle of Disposable Medical Masks



Figure 4.2 Improper Disposal Method of Disposable Medical Masks

3.2. Problem 2

What are the proper and improper methods/processes in the disposal of medical masks?

One respondent observed that the most common yet improper means of disposal include open trash burning, littering, and disposal in open-containers (figure 4.2). Each method creates their own negative effect on the state of the environment. Out of these three, the one that was frequently admitted by the survey respondents was the disposal in open-containers as seen in table 1. The waste coming from this process often ends up in open and unsecured dumping grounds which have become a commonplace for households to recover and recycle the objects found (Ferronato & Torretta, 2019). The continuation of these practices causes infections and viruses to be spread more rapidly.

3.3. Problem 3

What are the impacts of the production processes of disposable medical masks towards the environment?

Table 1. Improper Disposal Methods of Consumers and Medical Practitioners

Consumer/Medical Practitioner	Disposal Methods of Medical Masks
Consumer 1	"Put it in a bin filled with used masks"
Consumer 2	"I just throw it in the trashcan"
Consumer 3	"we just throw it in the trash can"
Consumer 4	"Usually, they are placed in our non-biodegradable waste basket after the straps/elastic has been cut off."
Consumer 5	"I throw them in my trash bin just like normal trash."
Consumer 6	"We cut it in the middle and roll it up before tossing it in the trash"
Consumer 7	"Honestly, I just throw it in the nearest trash bin."
Consumer 8	"By throwing it in the garbage."
Medical Practitioner 1	"Tear and throw in wastebasket"
Medical Practitioner 2	"for surgical mask put it in a garbage can but for special mask like Philips Fresh air mask with N95 clean it with alcohol and the n95 component can be replace after more than 5 usage"

As presented in figure 4, 92.9% of masks in the distributor's inventory is sold and this leads to the increase of product demand from consumers and suppliers.

To further discuss, two t-test: Two-Sample Assessing Unequal Variances was utilized to analyze the relationship between mask distributors and consumers. First, it computed a value of $P(t \leq t) = 0.697503595$ which shows there is no significant difference between the two variables; this indicates the increase of sales of masks because of the demand and need of the product in the context of the pandemic. Second, a value of $P(t \leq t) = 0.500136489$ indicates the significant difference between the targeted amount of sales and supplies. This implies the gap between the masks being supplied to distributors and consumed by the general public; there is a possible overproduction of masks which can create waste. As said by a mask distributor, the shelf life of a mask lasts from 3-5 years before considered "expired" or ineffective of use. The excess in inventory can lead to the expiration of product and ineffective usage.

3.4. Problem 4

What are the impacts of the disposal of disposable medical masks towards the environment?

The usage of disposable medical masks is the most effective type to be used as a preventive measure

for the virus because of the filtration from the exposure of aerosol spray with proper usage. Although according to figure 5, the usage also required proper disposal after usage as a health precaution, yet PPE is not classified under waste disposed of using proper methods of disposal.

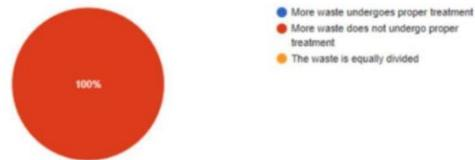

Figure 5. The Division of Waste Undergoing Proper and Improper Treatment according to Environmentalists

The improper disposal of these disposable medical masks results in certain aspects in energy consumption, waste production, and pollution which lead to severe repercussions that negatively affect the environment.

Energy Consumption

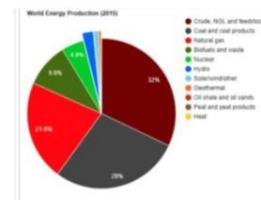

Figure 6. Energy Production and Usage as of 2015 (Hanania et al., 2020)

Based on figure 6, the second most utilized is non-renewable energy such as coal/coal products which are used to generate electricity that runs the technology to properly dispose of clinical waste, and with the increase of usage, the required energy is bound to have a direct relationship as well.

Waste Production

The improper disposal has led to the increase of waste in relation with the rate of demand and supply of PPE, and the added criteria of usage and disposal of this mask. The 3-ply masks are only effective up to six hours of usage then a replacement is needed. With the given condition, each individual consuming these masks must comply for maximum protection.

Especially for frontliners and the general public who are constantly exposed to the possibility of being infected. This circumstance has led to the doubling of healthcare waste wherein most do not undergo proper disposal.

Pollution

With the increase of the rate of waste production, 100% of these wastes are categorized to undergo the improper disposal (refer to figure 5). Under the category of improper waste, one specific process evident amidst the pandemic is discarding of masks in landfills which is shown to be borderline sustainable (refer to figure 7).

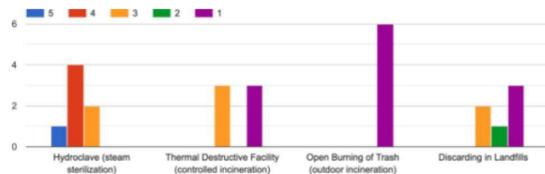

Figure 7. Level of Sustainability of Various Disposal Processes according to Environmentalists

Referring to figure 8, the disposal process of these medical masks greatly impact the environment in terms of pollution and this is highly evident in the present context of the improper disposal of masks.

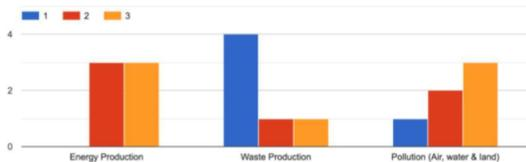

Figure 8. Casualties of Environmental Issues regarding the Life Cycle of Disposable Masks (1 - highest impact and 3 equivalents to the latter)

As seen in figure 9, the disposal process of the medical masks is the least sustainable portion of the life cycle and this is because of the three factors which are energy consumption, waste production and pollution as explained respectively.

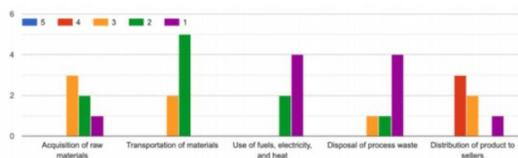

Figure 9. Sustainability of each Process in the Life Cycle of Medical Masks (5 equivalents to being the most Sustainable and 1 equivalents to the latter)

4. CONCLUSIONS

4.1. Summary of Findings

The following are the summary of the results that the researchers gathered from the surveys of the

study:

Disposable medical masks are the most utilized type of mask for the prevention of COVID-19 to spread. Therefore, 85.7% of mask distributors focus their attention on selling disposable medical masks as compared to cotton masks, N95's, and etc.

The production rate of disposable medical masks is higher than the consumption rate of the general public of this product. Therefore, the likeliness of product expiration is higher.

Among the mask consumers and medical practitioners, 71.4% of respondents improperly dispose of their medical face masks by placing them in regular waste bins rather than special color-coded waste bins specifically meant for healthcare waste.

A total of 100% in the HCWM officer focus group agree that open burning, littering, and disposal in open landfills are common improper means of disposal. The most sustainable process, yet still improper out of the three is littering.

In terms of waste production, the usage of disposable medical masks in the ongoing pandemic has been a factor leading to the increase of medical waste by 100%.

A total of 66.7% of environmentalists agree that the overall life cycle of disposable medical masks has the most impact on waste production, while 16.7% mentioned pollution received the highest impact.

4.2. Conclusions

The following conclusions are drawn based on the summary of findings:

While there is no significant difference between the number of masks sold and consumed, there is a significant difference between the number of masks supplied to these distributors and their sales. The overall life cycle gravely impacts environmental issues such as waste production, pollution, and energy consumption (arranged from most impacted to least impacted)

Most processes involved in the life cycle of disposable medical masks compromise the environmental sustainability of the product.

4.3. Recommendations

Having considered the summary of findings and conclusions in this chapter, the following recommendations are forwarded:

Future researchers are advised to look into and compare disposable medical masks to other variants to assess the suitability for prevention in the COVID-19 pandemic. In addition, to give medical disposable masks a point of comparison in terms of environmental sustainability.

To have a stronger foundation of data and information, the researchers suggest making use of a wider range of participants particularly in the HCWM



officers and mask manufacturers.

As brought up by one mask distributor, it is recommended to focus on the different levels of mask quality with regards to their respective price ranges to have an understanding of the value of materials involved in the life cycle assessment and to make an informative decision upon purchase.

Due to the lack of time and resources under the circumstance of the ongoing COVID-19 pandemic, the researchers advise to conduct an experiment in order to obtain empirical data and make use of this research paper as preliminary paper to further back up future results and findings.

5. ACKNOWLEDGMENTS

We would like to give our deepest appreciation and thanks to our ever-loving God who has been our motivation and spiritual guidance throughout the entire process.

To our families, who graced us with their loving support and motivation that allows us to pursue this topic.

To our classmates, friends, and all the other people who were always there to encourage and help us in all possible ways.

To our research adviser, Ms. Rose Marie C. Legaria and Ms. Mariz Ortega for constantly being open for consultations and selflessly sharing their knowledge and expertise to guide us throughout each step of this research.

To Medical Practitioners residing in the vicinity of Metro Manila for sparing time in answering our survey questionnaire regarding the effectiveness of disposable medical masks.

To our Waste Management Officer for sharing their expertise regarding the disposal process of healthcare waste in the Philippines.

To the Local Environmentalists for sharing their expertise regarding the environmental impacts of healthcare waste in the context of the COVID-19 pandemic.

To the mask consumers and distributors for sharing their expertise regarding the consumption and the rate of demand and supply of PPE.

6. REFERENCES

2019 Novel Coronavirus. (2019). Who.Int.
<https://www.who.int/emergencies/diseases/novel-coronavirus-2019>

Ansale, N. C. (2020). DENR REMINDS THE PUBLIC AGAINST BURNING OF THEIR GARBAGE. Dentr.Gov.Ph.
<https://r8.dentr.gov.ph/index.php/news-events/press-releases/1359-dentr-reminds-the-public-against-burning-of-their-garbage>

Ashifa, K. (2020). "More masks than jellyfish": coronavirus waste ends up in the ocean. The Guardian: The Guardian.
<https://www.theguardian.com/environment/2020/jun/08/more-masks-than-jellyfish-coronavirus-waste-ends-up-in-ocean>

Barr, S., & Gallagher, S. (2020). The new plastic bottle? How to dispose of face masks in an environmentally-safe way. The Independent.
<https://www.independent.co.uk/life-style/face-masks-coverings-dispose-throw-away-safe-environment-litter-single-use-a9612946.html>

Batino, C., & Karunungan, L. (2020). Philippines Virus Cases Top 80,000; Singapore Exceeds 50,000. Bloomberg.Com, N.PAG-N.PAG.
<https://www.bloomberg.com/news/articles/2020-07-26/philippines-virus-cases-top-80-000-singapore-exceeds-50-000>

Batino, C., Jiao, C., & Aditya, A. (2020). Doctors See High Mortality in Virus Fight in Philippines, Indonesia. Bloomberg.Com, N.PAG-N.PAG
<https://www.bworldonline.com/doctors-see-high-mortality-in-virus-fight-in-philippines/indonesia/>

Bernadas, J., & Ilagan, K. (2020). Journalism, public health, and COVID-19: some preliminary insights from the Philippines. Media International Australia, 177(1), 132–138. <https://doi.org/10.1177/1329878x20953854>

Bueza, M. (2020). IN CHARTS: COVID-19 cases in the Philippines. Rappler: Rappler. <https://www.rappler.com/newsbreak/iq/charts/coronavirus-covid-19-cases-philippines>

Bussemaker, N., & Felter, C. (n.d.). Which Countries Are Requiring Face Masks? Council on Foreign Relations. <https://www.cfr.org/in-brief/which-countries-are-requiring-face-masks>

Cabico, G. (2020). "Earth not healing": Medical waste piles up as COVID-19 cases rise. Philstar.com: Philstar.com.
<https://www.philstar.com/headlines/2020/08/15/2034986/earth-not-healing-medical-waste-piles-covid-19-cases-rise>

Calonzo, A., & Lopez, D. (2020). Philippines Lets Malls Reopen Further While Virus Deaths Rise—Bloomberg. <https://www.bloomberg.com/news/articles/2020-10-05/philippines-lets-malls-reopen-further-while-virus-deaths-rise>

Calonzo, A., & Lopez, D. (2020). Philippines Keeps Loose Covid Curbs in Capital Next Month. Bloomberg.Com, N.PAG-N.PAG.
<https://www.bloomberg.com/news/articles/2020-10-27/philippine-keeps-loose-covid-curb-s-in-capital-through-november>

CDC. (2020). Healthcare Workers. Centers for Disease Control and Prevention. <https://www.cdc.gov/coronavirus/2019-ncov/hcp/non-us-settings/emergency-considerations-ppe.html>

Chua, M., Cheng, W., Goh, S., Kong, J., Li, B., Lim, J., Mao, L., Wang, S., Xue, K., Yang, L., Ye, E., Zhang, K., Cheong, W., Tan, B., Li, Z., Tan, B., & Loh, X. (2020). Face Masks in the New COVID-19 Normal: Materials, Testing, and Perspectives. Research, 2020, 1–40.
<https://doi.org/10.34133/2020/7286735>

Cook, J., Nuccitelli, D., Green, S., Richardson, M., Winkler, B., Painting, R., Way, R., Jacobs, P., Skuce, A. (2013). Quantifying the consensus on anthropogenic global warming in the scientific literature. Environmental Research Letters, 8(2), 024024. <https://doi.org/10.1088/1748-9326/8/2/024024>

COVID-19 airway protection PPE overview. (2020). <https://www.mckinsey.com/~media/McKinsey/About%20Us/COVID%20Response%20Center/PDFs/COVID-19-PPE-Ops-Airway-Protection.pdf>

Das, O., Neisiany, R., Capezza, A., Hedenqvist, M., Försth, M., Xu, Q., Jiang, L., Ji, D., & Ramakrishna, S. (2020). The need for fully bio-based facemasks to counter coronavirus outbreaks: A perspective. Science of the Total Environment, 736, N.PAG-N.PAG.
<https://doi.org/10.1016/j.scitotenv.2020.139611>

Deaths Rise. Bloomberg.Com, N.PAG-N.PAG. Declarations. (2020). Insurance Journal, 98(12), 12–13.

Department of Environment and Natural Resources, Environmental Management Bureau. (2020). Provincial Guidelines on the Hazardous Waste Management During the Extended Enhanced Community Quarantine Period (Report no. 2020-20).

Edmond, C. (2020). How face masks, gloves and other coronavirus waste is polluting our ocean. World Economic Forum.
<https://www.weforum.org/agenda/2020/06/ppe-masks-gloves-coronavirus-ocean-pollution/>

Face Masks, Including Surgical Masks, and Respirators for COVID-19. (2020). FDA. <https://www.fda.gov/medical-devices/coronavirus-covid-19-and-medical-devices/face-masks-including-surgical-masks-and-respirators-covid-19>



3RD DLSU SENIOR HIGH SCHOOL RESEARCH CONGRESS

SUSTAINABILITY, ENVIRONMENT,
AND ENERGY

- Fadare, O., & Okoffo, E. (2020). Covid-19 face masks: A potential source of microplastic fibers in the environment. *The Science of the Total Environment*, 737, 140279. <https://doi.org/10.1016/j.scitotenv.2020.140279>
- Ferronato, N., & Torretta, V. (2019). Waste Mismanagement in Developing Countries: A Review of Global Issues. *International Journal of Environmental Research and Public Health*, 16(6), 1060. <https://doi.org/10.3390/ijerph16061060>
- Gambo, J., Ahmed, G., Hadejia, H., Idris, A., Babura, B., & Yusuf, Y. (2018). ASSESSING THE IMPACTS OF IMPROPER MEDICAL WASTE DISPOSAL AND RESIDENTS PERCEPTION OF THEIR DISPOSAL PRACTICES IN HADEJIA METROPOL. https://www.researchgate.net/publication/323368745_ASSESSING_THE_IMPACTS_OF_IMPROPER_MEDICAL_WASTE DISPOSAL_AND_RESIDENTS_PERCEPTION_OF_THEIR DISPOSAL PRACTICES_IN_HADEJIA_METROPOLIS_JI_GAWA_STAT_E_NIGERIA
- GOVERNMENT PH. (2020). [PDF] RA 11469: Bayanihan to Heal As One Act | Downloadable. Government PH. <https://governmentph.com/ra-11469/>
- Hanania, J., Heffernan, B., Jenden, J., Lloyd, E., Stenhouse, K., Toor, J., & Donev, J. (2020). Fuel—Energy Education. <https://energyeducation.ca/encyclopedia/Fuel>
- Health Care Waste Management. (2014). IWMI. <https://www.iwmiph.com/services/health-care-waste-management>
- Health-care waste management rapid assessment tool. (2016). World Health Organization. <https://doi.org/10.1181/whowh2016040101>
- Henneberry, B. (2020). How Surgical Masks are Made. Thomasnet.com: Thomas. <https://www.thomasnet.com/articles/other/how-surgical-masks-are-made/>
- International Organization for Standardization. (2006). Environmental management — Life cycle assessment — Principles and framework (ISO 14040:2006). <https://www.iso.org/standard/37456.html>
- Ivey, J. (2016). Demystifying Research. Is Descriptive Research Worth Doing? *Pediatric Nursing*, 42(4), 189–189.
- Jahangiri, M., Cousins, R., & Gharibi, V. (2020). Let's get back to work: Preventive biological cycle management of COVID-19 in the workplace. *Work*, 66(4), 713–716. <https://doi.org/10.3233/WOR-203217>
- Klemeš, J., Fan, Y., & Jiang, P. (2020). The energy and environmental footprints of COVID-19 fighting measures – PPE, disinfection, supply chains. *Energy*, 211, 118701. <https://doi.org/10.1016/j.energy.2020.118701>
- Klopffer, W., & Grahl, B. (2014). Life Cycle Assessment (LCA): A Guide to Best Practice. ResearchGate. https://www.researchgate.net/publication/285947771_Life_Cycle_Assessment_LCA_A_Guide_to_Best_Practice
- Ma, Y., Lin, X., Wu, A., Huang, Q., Li, X., & Yan, J. (2020). Suggested guidelines for emergency treatment of medical waste during COVID-19: Chinese experience. *Waste Disposal & Sustainable Energy*, 2(2), 81–84. <https://doi.org/10.1007/s42768-020-00039-8>
- Makato, T., Gamaralalage, P., Yugo Pratomo, I., Onogawa, K., Alverson, K., Honda, S., Ternald, D., Diley, M., Fujioka, J., & Condrorini, D. (2020). Waste Management during the COVID-19 Pandemic From Response to Recovery. United Nations Environment Programme. <https://www.iges.or.jp/en/pub/waste-management-during-covid-19-pandemic-response-recovery/en>
- Medical face mask production process. (n.d.). <https://www.maskexpert.com/new/Medical-face-mask-production-process.html>
- MedTecs International Corporation Limited. (2019). Medtecs, Safeguarding Every Tomorrow. Medtecs.com.tw. <http://www.medtecs.com.tw/en/>
- Metropolitan Manila Development Authority. (2019). Anti-littering. Mmda.gov.ph. <https://mmda.gov.ph/20-faq/2384-anti-littering.html>
- Narvaez, D., Benedictos, E., & Mogol, G. (2004). Health Care Waste Management Manual.
- DOH. https://doh.gov.ph/sites/default/files/publications/Health_Care_Waste_Management_Manual.pdf
- Niu, Z., Wang, T., Hu, P., Mei, J., & Tang, Z. (2020). Chinese Public's Engagement in Preventive and Intervening Health Behaviors During the Early Breakout of COVID-19: Cross-Sectional Study. *Journal of Medical Internet Research*, 22(8), e19995. <https://doi.org/10.2196/19995>
- Nzediegwu, C., & Chang, S. (2020). Improper solid waste management increases potential for COVID-19 spread in developing countries. *Resources, Conservation and Recycling*, 161, 104947. <https://doi.org/10.1016/j.resconrec.2020.104947>
- Parkinson, J. (2020). Coronavirus: Disposable masks “causing enormous plastic waste.” BBC News: BBC News. <https://www.bbc.com/news/uk-politics-54057799>
- Pfattheicher, S., Nockur, L., Böhm, R., Sassenrath, C., & Petersen, M. (2020). The Emotional Path to Action: Empathy Promotes Physical Distancing and Wearing of Face Masks During the COVID-19 Pandemic. *Psychological Science* (0956-7976), 31(11), 1363–1373. <https://doi.org/10.1177/0956797620964422>
- Philippine Clean Air Act of 1999, 20 (1999). http://www.congress.gov.ph/legisdocs/ra_11/RA08749.pdf
- Production of Disposable Surgical and Medical Face Mask. (n.d.). <https://www.entrepreneurindia.co/Document/Download/Production%20of%20Disposable%20Surgical%20and%20Medical%20Face%20Mask-67739-.pdf>
- Coronavirus Resource Center. (2021). Harvard Health. <https://www.health.harvard.edu/diseases-and-conditions/coronavirus-resource-center>
- Reusability of Facemasks During an Influenza Pandemic: Facing the Flu. (n.d.). <https://doi.org/10.17226/11637>
- Riedy, C. (2016). Climate Change. https://www.researchgate.net/publication/311301385_Climate_Change
- Ritchie, H., & Roser, M. (2013). CO₂ and Greenhouse Gas Emissions. Our World in Data. <https://ourworldindata.org/co2/country/philippines?country=-PHL>
- Rizan, C., Reed, M., & Bhutta, M. (2020). Environmental impact of Personal Protective Equipment supplied to health and social care services in... ResearchGate: unknown. https://www.researchgate.net/publication/345426529_Environmental_impact_of_Personal_Protective_Equipment_supplied_to_health_and_social_care_services_in_England_in_the_first_six_months_of_the_COVID-19_pandemic
- Sangkham, S. (2020). Face mask and medical waste disposal during the novel COVID-19 pandemic in Asia. *Case Studies in Chemical and Environmental Engineering*, 2, 100052. <https://doi.org/10.1016/j.csee.2020.100052>
- Togoh, I. (2020). Overwhelmed By Coronavirus Coverage? Here's How It Started, And The Essential Information You Need. Forbes.Com, N.PAG. <https://www.forbes.com/sites/isabeltogoh/2020/03/13/overwhelmed-by-coronavirus-coverage-heres-how-it-started-and-the-essential-information-you-need/?sh=79bc7a406145>
- Yurasits, B. (2020). Five things you should know about disposable masks and plastic pollution. UN News. <https://news.un.org/en/story/2020/07/1069151>
- Zhai, Z. (2020). Facial mask: A necessity to beat COVID-19. *Building and Environment*, 175, 106827. <https://doi.org/10.1016/j.buildenv.2020.106827>



A Systematic Review on Water Hyacinth (*Eichhornia crassipes*) as a Biosorbent of Cadmium

Daryll Hans T. Go, Genrish Wendell N. Ng, Trisha Danielle K. Sia
and Kathlyn L. Tio

De La Salle University Integrated School, Manila

Abstract: Water hyacinth has gained a noteworthy reputation as the worst invasive macrophyte for its alarming proliferation rates, threatening transportation and irrigation systems and ecosystem biodiversity. Sustainable efforts have found the plant to demonstrate efficiency in sequestering toxic heavy metals such as cadmium from marine environments. Cadmium presence in water, primarily caused by anthropogenic sources, poses public health risks due to its toxicity. Consequently, studies on the applications of *Eichhornia crassipes* and the removal of cadmium have become active research areas in recent decades. This review presents literature related to the Cd sorption capacity of water hyacinth biosorbents. The effects and optimization of parameters including treatment, temperature, pH, initial sorbate and sorbent concentration have been explored in classical and competitive adsorption models. Investigations on kinetics, equilibrium, and desorption studies have also been conducted. From the gathered literature, water hyacinth biosorbents show potential for industrial-scale applications, but its metal recovery and utilization in multi-metal and continuous sorption may require further evaluation.

Key Words: water hyacinth; biosorption; batch adsorption; cadmium; heavy metals

1. INTRODUCTION

Millions of cubic meters of untreated wastewater are disposed of in Manila Bay and Laguna Lake annually (International Water Association, 2018). Within these emissions are potential heavy metals that significantly impact the environment. Cadmium (Cd) is a naturally-occurring, heavy metal that bioaccumulates in organisms, causing adverse health effects such as cancer and toxicity in various organ systems (Rahimzadeh et al., 2017). Industrial effluents released from manufacturing processes are the primary anthropogenic pathway of Cd into the environment (Rao et al., 2010). Moreover, the Cd concentration of tap water sourced from Metro Manila reached 4.78ppm, exceeding the permissible concentration of 0.005ppm set by the WHO (Solidum & Solidum, 2012; World Health Organization, 2010).

To reduce its lethality, remediation techniques such as chemical precipitation, ion exchange separation, adsorption, filtration, reverse osmosis, solvent extraction, and electrochemical treatment have been developed, but most entail expensive operating costs (Wolowiec et al., 2019). Adsorption, however, has been preferred due to its low cost and high efficiency, particularly with the use of agricultural by-products (Lee et al., 2015).

Water hyacinth (*Eichhornia crassipes*) is regarded as the world's most invasive macrophyte for its alarming growth. It reduces oxygen levels in

aquatic ecosystems and encourages diseases in nearby communities. Despite its disadvantages, its biomass has been reported by numerous valorization studies to be efficient in remediating polluted waters and removing toxic heavy metals like Cd. With the need for cost-efficient sustainable adsorbents, the high biomass production, tolerance to pollution, and adsorption capacity of water hyacinths qualify them as effective biosorbents (Priya & Selvan, 2017).

Through a systematic review of literature, relevant studies on Cd biosorption by *E. crassipes* were synthesized. Particularly, it aimed to evaluate the effects of sorbent treatments and experimental parameters, identify optimal conditions for Cd adsorption by water hyacinth (WH) biosorbents, and determine their applicability in industrial-scale operations.

The paper is solely centered on *E. crassipes* biomass as a sorbent of Cd. Different methodologies and adsorption systems were considered, where the biosorption capacity of WH was determined through real experiments. The relevance of output limited the reference articles to have been published within the last three decades.

2. METHODOLOGY

The Preferred Reporting Items for Systematic Reviews and Meta-Analyses (PRISMA) guidelines, which include a screening process for articles from

electronic databases, i.e., Scopus, ScienceDirect, and PubMed, were implemented. The keywords used in the initial search include the following terms and their combinations: “water hyacinth” OR “Eichhornia crassipes” AND “cadmium” OR “Cd” AND “adsorption” OR “biosorption”. Following established inclusion and exclusion criteria, twenty-nine studies on Cd sorption by WH were deemed eligible (Figure 1).

A data extraction form was utilized to summarize and obtain specific information from the studies. The following items were included: (a) identification data; (b) adsorption type; (c) adsorbent parameters; (d) experimental parameters; (e) maximum sorption capacity; and (f) desorption data. Studies that had consistencies in variables, methodology, and results were sorted and tabulated. Analyses involved the comparison of results, particularly the influence of treatments and parameters on the adsorption capacity of the WH biosorbents.

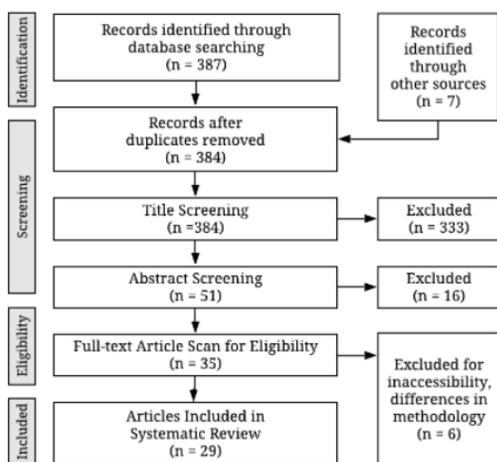

Figure 1. Adapted PRISMA screening process

3. RESULTS AND DISCUSSION

3.1 Classification of Sorbents

Three categories of sorbents were recognized in the studies: live, dried, and pyrolyzed WH biosorbents. Forty-eight percent were conducted using dried *E. crassipes*, while live biomass and biochar studies each comprised twenty-four percent of publications. One study conducted simulation studies (Soriano et al., 2016) which did not fit in any of the aforementioned classifications. All sorbent types exhibited effective Cd sorption capacity, with the highest removal rates for dried biomass, live water hyacinth and *E. crassipes* biochars being 99.9%, 100%

and 99.24% respectively (Manju et al., 2016; Swain et al., 2014; Li et al., 2016).

3.2 Live Water Hyacinth Biomass for Cadmium Sorption

With the usage of live sorbents, phytoremediation studies precede the more common adsorption methods at present. Cd is primarily bound to WH via peptides (Romanova & Shuvaeva, 2015) while the cell wall and subcellular fractions of tissues account for most of the uptake (Fett et al., 1994b). Four studies applied live WH sorption for Cd removal (Table 1).

From the collated articles, untreated, raw and live *E. crassipes* biomass have been observed to perform well in terms of Cd sorption at near-neutral pH levels of 6.0-7.0. Acidic conditions have been found to be less ideal due to the binding competition between Cd²⁺ and H⁺ ions to WH adsorption sites. Similarly, Cd removal is most favorable in the absence of other metals; single-sorption systems produced the best Cd removal rates. (Hasan et al., 2007; Patel et al., 2014; Mishra & Tripathi, 2008). It was found that longer exposure times (≥10 days) led to higher Cd accumulations. Moreover, the highest percent removal was at minimum initial Cd concentrations. While modifications might improve the metal uptake of *E. crassipes*, cadmium, at high concentrations, bears toxic effects on WH and suppresses plant growth and absorption (Fett et al., 1994a; Mishra & Tripathi, 2008). At larger scales where Cd is prevalent, live sorbents are not as reliable for removal.

3.3 Application of Dried Water Hyacinth Biomass in Cadmium Removal

Table 1. Batch cadmium sorption using live WH biomass.

Biomass Part	Optimal Parameters	Removal Sorption Capacity	Reference
Roots, Shoots	pH 7.0; 1.0 mg L ⁻¹ Cd(II); 16 days	92.0% – single 73.2% – binary (vs Zn)	Hasan et al. (2007)
Whole Biomass	2.0 mg L ⁻¹ metal concentrations; 12 days	0.31 mg g ⁻¹ ; 85% – quinary (vs Cu, Cr, Zn, Fe)	Mishra & Tripathi (2008)
Whole Biomass	pH 6; 10 mg L ⁻¹ Cd	20.54%	Patel et al. (2014)
Whole Biomass	pH 6.7; 0.27 mg L ⁻¹ Cd; 15 days	100%	Swain et al. (2014)

The Cd removal behavior of dried water hyacinth roots, shoots, and whole biomass has also been studied in various conditions (Table 2). To maximize surface area and available sites for adsorption, the biomass is usually dried and crushed into powder. According to Khatoon et al. (2016), pretreatment of biosorbents may result in the opening of biopolymer rings, increasing porosity and stability,



ultimately improving the heavy metal removal efficiency of the sorbent.

The effects of different pretreatment factors, including drying temperature and sorbent size on the

Table 2. Batch cadmium adsorption via dried WH biomass.

Biosorbent Treatment	Optimal Parameters	Removal/Sorption Capacity	Reference
Whole biomass, dried at 60°C		27 mg g ⁻¹ - quaternary (vs Pb, Cu, Zn)	Schneider et al. (1995)
Acid-treated biomass, oven-dried at 65°C for 12h	pH 7.10; 250 mg L ⁻¹ Cd; 3.5 g L ⁻¹ sorbent dose	87.54 mg g ⁻¹	Mahamadi & Nharingo (2006)
Acid-treated roots, oven-dried at 65°C for 12h	pH 5.8; 300 mg L ⁻¹ Cd	4.0 mg L ⁻¹ - quaternary (vs K, Ca, Mg)	Mahamadi & Zaranyika (2007)
Whole biomass, dried at 70°C for 48h	30 mg L ⁻¹ Cd	1.98 mg g ⁻¹ - single; 1.96 mg g ⁻¹ - binary (vs Cu, Zn, Ni, Pb, Cr); ~98%	Verma et al. (2008)
Ash, air-dried and oven-dried, burnt at 220°C	30 µg mL ⁻¹ Cd	28.41 µg g ⁻¹	Mahmood et al. (2010)
Acid-treated roots, sun-dried for 2d, oven-dried at 65°C for 12h		9.92 mg g ⁻¹ - single 2.43 mg g ⁻¹ - binary (vs Pb); 6.42 mg g ⁻¹ - binary (vs Zn) 3.01 mg g ⁻¹ - ternary (vs Pb, Zn)	Mahamadi & Nharingo (2010)
Whole biomass, dried separately at 30°C, 50°C	pH 5.0 30°C drying temperature; non-uniform sorbent size; 30°C; 60 min contact time	0.667 meq g ⁻¹ , >60% - binary (vs Zn)	Modenes et al. (2011)
Roots, shoots, dried at 65°C for 48h	pH 5.0; 50 mg L ⁻¹ Cd;	79.65% - roots; 79.22% - shoots	Ibrahim et al. (2012)
	5.0 g L ⁻¹ sorbent dose; 60 min contact time		
Acid-washed whole biomass, oven-dried at 60°C for 24h	pH 6.0; 0.2 g mL ⁻¹ sorbent dose; 300 mg L ⁻¹ Cd; 45°C; 175 rpm	104.16 mg g ⁻¹	Murithi et al. (2014)
<i>Emericella nidulans</i> -immobilized biomass, dried at 50°C	pH 6.0; 1% sorbent dose; 100 mg L ⁻¹ Cd; 120 min sorption time; 40°C	99.9%	Manju et al. (2016)
Roots, dried at 70°C	pH 6.0; 0.267 mmol L ⁻¹ Cd and 0 mmol L ⁻¹ Cu - binary;	5.43% - single 0.62% - binary (vs Cd) (in Cd/biomass Wt%)	Zheng et al. (2016)
Leaves, dried in shade for 3d	pH 8; 250 mg L ⁻¹ Cd	96%	Hassoon & Najem (2017)
Sodium-alginate microspheres, oven-dried at 105°C	96h sorption time	94.2%	Grenni et al. (2019)
Shoots, oven-dried at 60°C	pH 6.5; 5 g L ⁻¹ sorbent dose; 10 mg L ⁻¹ Cd; 60 min sorption time	21.6 mg g ⁻¹	Li et al. (2020)

maximum adsorption of the WH have been taken into consideration. Modenes et al. (2011) observed greater adsorption capacity at the lower drying temperatures due to greater pore size contraction at high temperatures. Modenes et al. (2011) also found little variation in adsorption capacity of different sorbent particle sizes.

The studies on dried WH biosorption of Cd have determined different parameters to maximize adsorption rates. Several studies have found that a neutral acidity of pH 5.0 to 7.0 would be optimal for Cd adsorption due to a lower concentration of hydrogen ions competing for the sorption sites on the sorbent (Modenes et al., 2011; Manju et al., 2016; Zheng et al., 2016). Sorbent dose affects the electrostatic interactions between particles, and a ceiling of adsorptive capacity emerges at greater

sorbent doses (Ibrahim et al., 2012). At 0.2 to 0.5mm, 5g L⁻¹ of biomass reached maximum adsorption, while 1.0mm particle size plateaued at 0.2g mL⁻¹; this signifies that the use of a smaller sorbent size requires less sorbent to reach the optimal amount (Ibrahim et al., 2012; Murithi et al., 2014; Li et al., 2020). Initial Cd concentration also affects the adsorption capacity of the biomass. With a greater amount of Cd ions present, the increased rate of adsorption reaction causes more amounts of the metal to be adsorbed but decreases the removal percentage of Cd (Mahamadi & Zaranyika, 2007; Mahamadi & Nharingo, 2006; Li et al., 2020; Murithi et al., 2014; Manju et al., 2016). The adsorption of Cd ions by WH consistently followed the pseudo-second-order model and fitted the Langmuir adsorption model. With the presence of other heavy metals, the competitive adsorption of Pb and Zn significantly hindered the adsorption of Cd, while Na, K, Mg and Ca had minimal to no impact (Mahamadi & Nharingo, 2010; Murithi et al., 2014).

3.4 Cadmium Biosorption via Water Hyacinth Biochar

The utilization of water hyacinth-derived biochars for Cd removal from aqueous solutions is relatively unexplored, with publications surfacing only recently (Table 3). However, it is a promising method to manage the invasive species and immobilize Cd effectively.

The heating temperature during biochar generation influences adsorption capacity. A pyrolysis temperature between 450°C to 700°C is found to be ideal (Zhang et al., 2015; Ding et al., 2016; Li et al., 2016). Ding et al. (2016) inferred that higher pyrolysis temperatures encouraged surface area and porous structure, but increasing the temperature beyond 600°C causes the loss of oxygen-containing groups. Increasing temperature results in greater Cd removal, but extreme heat dissipates functional groups essential for adsorption. Zhou et al. (2019) recommended a heating rate of 15°C min⁻¹ for 2 hours, demonstrating a slow pyrolysis to be most effective.

Compared to dried and live biosorbents, WH biochars appear to be better accumulators of Cd at high and low initial concentrations in terms of adsorption capacity and metal removal. Higher concentrations of Cd require longer exposure times as presented by Zhang et al. (2015). Solution temperature heavily influences the adsorption behavior of biochars due to its endothermic characteristic (Ding et al., 2016; Liu et al., 2020),



wherein increasing the temperature during sorption encourages Cd sorption mechanisms to occur. Solution pH has been considered as one of the most influential factors to the adsorption capacity of biochars. The surplus of H⁺ at low pH levels (>2.50) overwhelmed and protonated the negatively-charged biochar surface, repelling Cd²⁺; thus, a moderate pH level of 5.0-6.0 has been deemed optimal (Ding et al., 2016; Li et al., 2016; Liu et al., 2020).

Table 3. Batch cadmium adsorption by WH biochars.

Biochar Treatment	Optimal Parameters	Removal/Sorption Capacity	Reference
Acid-washed biochar	450°C pyrolysis; 24h sorption time	70.313 mg g ⁻¹	Zhang et al. (2015)
WH Biochar	450°C pyrolysis; pH 5.0; 100 mg L ⁻¹ Cd; 30°C	74.99 mg g ⁻¹	Ding et al. (2016)
WH Biochar	700°C pyrolysis; 1.0 g L ⁻¹ sorbent dose; pH 5.0; 1mol L ⁻¹ Cd; 25°C	25.826 mg g ⁻¹ , 99.24%	Li et al. (2016)
Root biochar	500°C pyrolysis; 1.0 g L ⁻¹ sorbent dose; 100 mg L ⁻¹ Cd; 298K	39.81 mg g ⁻¹ , 96.24%	Li et al. (2018)
Roots, leaves biochar pellets immobilized with <i>Chlorella</i> sp.	pH 6.0; 10 mg L ⁻¹ Cd(II); leaf biochar pellet immobilized with <i>Chlorella</i> sp.; 119 μmol m ⁻² s ⁻¹ illumination	13.81 mg g ⁻¹ , 92.45%	Shen et al. (2018)
Stem biochar	400°C pyrolysis; 2h heating time; 15°C min ⁻¹ heating rate;	20.175 mg g ⁻¹ , 80.70%	Zhou et al. (2019)

3.5 Cadmium Desorption and Recovery

Biomass regeneration potential and cadmium recovery are necessary determinants for the applicability of WH biosorbents at industrial scales. The practical efficiency of a biosorbent is determined not only by its adsorptive capacity but also by its accessibility and potential for reuse.

Shen et al. (2018) reported the use of nitric acid as an eluent at lower molar concentrations, wherein the Cd (II) removal efficiency of *E. crassipes* biochar pellets remained at 91.1% after three adsorption-desorption cycles. Meanwhile, Zheng et al. (2016) utilized Cu (II) ions, that have high affinity to sorption sites, to desorb over 90% of Cd (II) from dried biomass. Liu et al. (2020) demonstrated the sustainability of WH biochar-alginate capsules, which retained up to 70% of its initial adsorption capacity following 10 reuses.

As shown in Table 4, a number of studies accounted for the usefulness of the high Cd desorption capacity of WH for biomass regeneration and Cd recovery (Mahmood et al., 2010; Ding et al., 2016; Shen et al., 2018). However, at present circumstances, a survey of literature shows that WH-biosorption studies expounding on Cd recovery are limited.

Table 4. Cadmium desorption by WH biosorbents.

Biosorbent Type	Eluent	Maximum Desorption Capacity	Reference
WH-derived ash	HNO ₃	27.54 μg g ⁻¹ , 96.9%	Mahmood et al. (2010)
WH biochar (450°C)	HCl	≈60%	Ding et al. (2016)
Dried WH roots	Cu	>90%	Zheng et al. (2016)
WH leaf biochar pellets	HNO ₃		Shen et al. (2018)

4. CONCLUSIONS

Water hyacinth biosorption is an effective means for cadmium remediation. Through biosorption applications, the environmental concerns associated with the toxicity of cadmium and the invasive property of *E. crassipes* are minimized. Several solution and sorbent parameters significantly impact its adsorption capacity. Cadmium sorption is favored at near-neutral pH levels to reduce competition with interfering ions, while lower initial sorbent and sorbate concentrations allow maximized adsorption without risk of precipitation. Unlike dried biomass, live biosorbents are hindered by metal toxicity. Pretreatment of biomass is advantageous as dried biosorbents have consistent efficient removal rates. However, biochar studies have become more prominent in recent years. The inclusion of pyrolysis at high temperatures allows more sorbent modifications such as the increased presence of functional groups, porosity, and surface area that aid in adsorption. Despite the accessibility, inexpensive cost, and excellent removal capacity of WH biomass, its usage in industrial scales requires further investigation, specifically on the themes of cadmium desorption, metal recovery, multi-metal, and continuous sorption systems.

5. ACKNOWLEDGMENTS

The researchers would like to express their gratitude to Dr. Allan N. Soriano from the Chemical Engineering Department of the Gokongwei College of Engineering, of De La Salle University-Manila for his unwavering guidance and supervision during the development of this manuscript. His instruction and generosity are without parallel.

6. REFERENCES

- Ding, Y., Yunguo, L., Liu, S., Li, Z., Tan, X., Huang, X., Zeng, G., Zhou, Y., Zheng, B., & Cai, X. (2016, January). Competitive removal of Cd(II) and Pb(II) by biochars produced from water hyacinths: performance and mechanism. *Royal Society of Chemistry Advances* 2016, 6, 5223-5232. <https://doi.org/10.1039/c5ra26248h>
- Fett, J.P., Cambraia, J., Oliva, M.A. & Jordão, C.P. (1994a, June). Cadmium uptake and growth inhibition in Water Hyacinth: effect of nutrient solution factors. *Journal of Plant Nutrition*, 17(7), 1205-1217. <https://doi.org/10.1080/01904169409364799>
- Fett, J.P., Cambraia, J., Oliva, M.A. & Jordão, C.P. (1994b, June). Absorption and distribution of cadmium in Water Hyacinth plants. *Journal of Plant Nutrition*, 17(7), 1219-1230. <https://doi.org/10.1080/01904169409364800>



- Grenni, P., Caracciolo, A.B., Mariani, L., Cardoni, M., Ricucci, C., Elhaes, H., & Ibrahim, M. (2019, June). Effectiveness of a new green technology for metal removal from contaminated water. *Microchemical Journal*, 147, 1010-1020. <https://doi.org/10.1016/j.microc.2019.04.026>
- Hasan, S.H., Talat, M., & Rai, S. (2007, March). Sorption of cadmium and zinc from aqueous solutions by water hyacinth (*Eichhornia crassipes*). *Bioresource Technology*, 98(4), 918-928. <https://doi.org/10.1016/j.biortech.2006.02.042>
- Hassoon, H.A. & Najem, A.M. (2017, September 23). Removal of Some Traces Heavy Metals from Aqueous Solutions by Water Hyacinth Leaves Powder. *Iraqi Journal of Science*, 58(2A), 611-618.
- Ibrahim, H.S., Ammar, N.S., Soyalk, M., & Ibrahim, M. (2012, October). Removal of Cd(II) and Pb(II) from aqueous solution using dried water hyacinth as a biosorbent. *Spectrochimica Acta Part A: Molecular and Biomolecular Spectroscopy*, 96, 413-420. <https://doi.org/10.1016/j.saa.2012.05.039>
- International Water Association. (2018). *Wastewater Report 2018*. <https://reliefweb.int/sites/reliefweb.int/files/resources/OFID%20Wastewater%20report%202018%20screen.pdf>
- Lee, C., et al. (2015, March 24). Lead and copper removal from aqueous solutions using carbon foam delivered from phenol resin. *Chemosphere*, 130, 59-65. <https://doi.org/10.1016/j.chemosphere.2015.02.055>
- Li, F., Shen, K., Long, X., Wen, J., Xie, X., Zeng, X., Liang, Y., Wei, Y., Lin, Z., Huang, W., & Zhong, R. (2016, February 16). Preparation and Characterization of Biochars from *Eichhornia crassipes* for Cadmium Removal in Aqueous Solutions. *PLoS One*, 11(2), e0148132. <https://doi.org/10.1371/journal.pone.0148132>
- Li, M., Xiao, X., Wang, S., Zhang, X., Li, J., Pavlostathis, S.G., Luo, X., Luo, S., & Zeng, G. (2020, June). Synergistic removal of cadmium and organic matter by a microalgae-endophyte symbiotic system (MESS): An approach to improve the application potential of plant-derived biosorbents. *Environmental Pollution*, 261, 114117. <https://doi.org/10.1016/j.envpol.2020.114177>
- Li, Q., Tang, L., Hu, J., Jiang, M., Shi, X., Zhang, T., Li, Y., & Pan, X. (2018, October 5). Removal of cadmium from aqueous solution by biochars derived from long-root *Eichhornia crassipes*. *Royal Society open science*, 5(10), 180966. <https://doi.org/10.1098/rsos.180966>
- Liu, C., Ye, J., Lin, Y., Wu, J., Price, G.W., Burton, D., & Wang, Y. (2020, September). Removal of Cadmium (II) using water hyacinth (*Eichhornia crassipes*) biochar alginate beads in aqueous solutions. *Environmental Pollution*, 264(2020), 114785. <https://doi.org/10.1016/j.envpol.2020.114785>
- Mahamadi, C. & Nharingo, N. (2006, June). Modelling the kinetics and equilibrium properties of cadmium biosorption by river green alga and water hyacinth weed. *Toxicological and Environmental Chemistry* 89(2), 297-305. <https://doi.org/10.1080/02772240601010063>
- Mahamadi, C. & Nharingo, T. (2010, February). Competitive adsorption of Pb²⁺, Cd²⁺ and Zn²⁺ ions onto *Eichhornia crassipes* in binary and ternary systems. *Bioresource Technology*, 101(3), 859-864. <https://doi.org/10.1016/j.biortech.2009.08.097>
- Mahamadi, C. & Zaranyika, M. (2007). Adsorption of cadmium from aqueous solution by acid-treated water hyacinth weed *Eichhornia Crassipes*, in the presence of K, Ca and Mg: Role of non-spectroscopic interferences during ICP-AES determination. *Electronic Journal of Environmental, Agricultural and Food Chemistry*, 6(5), 2034-2044.
- Mahmood, T., Malik, S.A. & Hussain, S. (2010, May). Biosorption and recovery of heavy metals from aqueous solutions by *eichhornia crassipes* (water hyacinth) ASH. *Bioresources*, 5(2):1244-1256.
- Manju, Kumari, S., Sharma, J., Gupta, S., Kumar, M., Kumar, S.S., Kumar, A., Verma, A., Shalu, Sharma, P., Bajawa, K., Lal, S., & Bishnoi, N.R. (2016, September 29). An Assessment of Cadmium Removal from Simulated Waste Water Using Leftover Biomass of Water Hyacinth Immobilized via *Emericella nidulans*. *Journal of Applied Life Sciences International*, 8(3), 1-10. <https://doi.org/10.9734/JALSIS/2016/27845>
- Mishra, V.K. & Tripathi, B.D. (2008, October). Concurrent removal and accumulation of heavy metals by the three aquatic macrophytes. *Bioresource Technology*, 99(15), 7091-7097. <https://doi.org/10.1016/j.biortech.2008.01.002>
- Módenes, A.N., Espinoza-Quifones, F. R., Borba, C.E., Trigueros, D. E. G., Lavarda, F. L., Abugderah, M. M. & Kroumov A. D. (2011, October). Adsorption of Zn(II) and Cd(II) ions in batch system by using the *Eichhornia crassipes*. *Water Science & Technology*, 64(9), 1857-1863. <https://doi.org/10.2166/wst.2011.764>
- Murithi, G., Onindo, C.O., Wambu, E.W., & Muthakia, G.K (2014, May). Removal of Cadmium(II) Ions from Water by Adsorption using Water Hyacinth (*Eichhornia crassipes*) Biomass. *BioResources*, 9(2), 3613-3631. <https://doi.org/10.15376/biores.9.2.3613-3631>
- Patel, K.P., Patel, P.M., & Patel, K.M. (2014, March). Removal of Zinc and Cadmium by two aquatic plant water lettuce (*Pistia stratiotes*) and water hyacinth (*Eichhornia crassipes*). *Environmental Science & Technology* (2014), 2.
- Priya, S., & Selvan, S. (2017). Water Hyacinth (*Eichhornia Crassipes*) – An Efficient and Economic Adsorbent for Textile Effluent Treatment – A Review. *Arabian Journal of Chemistry*, 10(2), S3548-3558. <https://doi.org/10.1016/j.arabjc.2014.03.002>
- Rahimzadeh, M. R., Rahimzadeh, M. R., Kazemi, S., & Moghadamnia, A.-akbar. (2017). Cadmium Toxicity and Treatment: An Update. *Caspian J Intern Med*, 8(3), 135-145. <https://doi.org/10.22088/cjim.8.3.135>
- Romanova, T.E. & Shuvaeva, O. (2015, July). Identification of the binding forms of cadmium during accumulation by water hyacinth. *Chemical Speciation and Bioavailability*, 27(3), 139-145. <https://doi.org/10.1080/09542299.2015.1113388>
- Schneider, I.A.H., Rubio, J., & Smith, R.W. (1995, September). *Eichhornia crassipes* as biosorbent for heavy metal ions. *Minerals Engineering*, 8(9), 979-988. [https://doi.org/10.1016/0892-6875\(95\)00061-T](https://doi.org/10.1016/0892-6875(95)00061-T)
- Shen, Y., Zhu, W., Huan, L., Ho, S., Chen, J., Xie, Y., & Shi, X. (2018 June). Enhancing cadmium bioremediation by a complex of water-hyacinth derived pellets immobilized with *Chlorella sp.* *Bioresource Technology*, 257, 157-163. <https://doi.org/10.1016/j.biortech.2018.02.060>
- Solidum, J. & Solidum, G. (2012). Assessment and Remediation of Heavy Metals in Community Tap Water from Manila, Philippines. 2012 International Conference on Environmental Science and Engineering IPCBEE, 32.
- Soriano, A.N., Orfiana, O.N., Pangon, M.B., Nieva, A.D., & Adornado, A.P. (2016). Simulated Biosorption of Cd(II) and Cu(II) in Single and Binary Metal Systems by Water Hyacinth (*Eichhornia crassipes*) using Aspen Adsorption. *ASEAN Journal of Chemical Engineering*, 16(2), 21-43. <https://doi.org/10.22146/AJCHE.49892>
- Swain, G., Adhikari, S., & Mohanty, P. (2014, February). Phytoremediation of Copper and Cadmium from Water Using Water Hyacinth, *Eichhornia Crassipes*. *International Journal of Agricultural Science and Technology*, 2(1), 1. <https://doi.org/10.14355/ijast.2014.0301.01>
- Verma, V.K., Tewari, S., & Rai, J.P.N. (2008, April). Ion exchange during heavy metal bio-sorption from aqueous solution by dried biomass of macrophytes. *Bioresource Technology*, 99(6), 1932-1938. <https://doi.org/10.1016/j.biortech.2007.03.042>
- Wolowiec, M., Komorowska-Kaufman, M., Pruss, A., Rzepa, G., & Bajda, T. (2019, August 14). Removal of Heavy Metals and Metalloids from Water Using Drinking Water Treatment Residuals as Adsorbents: A Review. *Minerals* 2019, 9(8), 487. <https://doi.org/10.3390/min9080487>
- World Health Organization. (2010). EXPOSURE TO CADMIUM: A MAJOR PUBLIC HEALTH CONCERN. <https://www.who.int/ipcs/features/cadmium.pdf>
- Zhang, F., Wang, X., Yin, D., Peng, B., Tan, C., Liu, Y., Tan, X., & Wu, S. (2015, April 15). Efficiency and mechanisms of Cd removal from aqueous solution by biochar derived from water hyacinth (*Eichhornia crassipes*). *Journal of Environmental Management*, 153, 68-73
- Zheng, J., Liu, H., Feng, H., Li, W., Lam, M.H., Lam, P.K., & Yu, H. (2016, December). Competitive sorption of heavy metals by water hyacinth roots. *Environmental Pollution*, 219, 837-845. <https://doi.org/10.1016/j.envpol.2016.08.001>
- Zhou, R., Ming, Z., Zhou, J. & Wang, J. (2019, November). Optimization of biochar preparation from the stem of *Eichhornia crassipes* using response surface methodology on adsorption of Cd²⁺. *Scientific Reports*, 9(1), 17538. <https://doi.org/10.1038/s41598-019-54105-1>



An Experimental Study on Sugarcane (*Saccharum officinarum*) Bagasse and Corn (*Zea mays* L.) cob as a Potential Bio-adsorbent for Used Engine Oil

Alyssa Marygrace M. Hugo, Julius Alvin A. Librando, and Yuji C. Muñoz
De La Salle University Integrated School, Biñan City, Laguna

Abstract: Oil pollution is one of the leading causes of detriment to water ecosystems. Bio-adsorbents have been studied for oil cleanup potential, but mixed bio-adsorbents have not been thoroughly studied yet. Thus, this study investigated Sugarcane (*Saccharum officinarum*) bagasse and Corn (*Zea mays*) cobs, two of the most underutilized agricultural wastes, as bio-adsorbents in their natural form. Five formulations were used, and used motor oil was utilized as the adsorbate. One gram of bio-adsorbent was used in a mixture of 3 grams of oil and 200 milliliters of water per trial. The oil sorption capacity (OSC) and water sorption amounts were collected to determine the efficiency in selectively adsorbing motor oil. Results showed that all formulations had similar oil sorption capacities, ranging from 288% to 298%, with pure bagasse (F1) having the highest and the formulation with a bagasse-cob mass ratio of 3:1 (F2) having the lowest. Statistical analysis posited that all group means for OSC are equal. Additionally, findings suggested that water sorption amount increases as the percentage by mass of bagasse in the formulation increases. F1 sorbed the most water with 5.80 grams, whereas the formulation with pure cobs (F5) sorbed the lowest with 2.09 grams, followed by the formulation with a bagasse-cob mass ratio of 1:3 (F4) with 3.22 grams. These results signified that not all mean water sorption amounts measured were equal, suggesting that formulations F4 and F5 are the most efficient in selectively absorbing oil.

Key Words: *Saccharum officinarum*; *Zea mays*; oil sorption capacity; bio-adsorbents

1. INTRODUCTION

Oil spills are one of the leading causes of water pollution worldwide, posing dangers to aquatic habitats, poisoning fishes, and affecting people's livelihoods in coastal communities (National Oceanic and Atmospheric Administration, 2019). The majority of these spills are caused by human activity, particularly the runoff from cars that leak motor oil. Though there are multiple ways of dealing with oil spills, the use of adsorbents is primarily seen as being most effective due to its flexibility and simplicity (Crini et al., 2018). Synthetic materials form the most significant proportion of all adsorbents, but while they are effective and yield a high oil sorption capacity, their non-biodegradability, cost, and disposal method may sometimes outweigh their benefits (Al-Jammal & Juzsakova, 2017). An alternative route may be the use of bio-adsorbents—adsorbents derived from biological material like agricultural wastes (agro-wastes) (Crini et al., 2018). While this method has been thoroughly researched, most procedures focus on chemically treating agro-waste via silanization, acetylation, and other treatments to make it less hydrophilic (Gorgulho

et al., 2018). The hydrophilic nature of agro-waste due to its cellulose content is one of the major limiting factors in the mainstream use of adsorbents. Suitable adsorbents must repel water to prevent sinking, requiring a minimum water sorption amount (Guilharduci et al., 2017). However, recent papers have demonstrated the potential of certain agro-wastes to attain promising results without chemical treatments. In particular, Choi (2018) showed the potential of powdered corn cobs in adsorbing large amounts of oil due to their low hydroxyl action, making them naturally hydrophobic. Behnood et al. (2016) and Gorgulho et al. (2018), on the other hand, demonstrated the potential of sugarcane bagasse as a decent bio-adsorbent due to its floatability and high surface area.

Though these studies have laid the groundwork on the feasibility of bagasse and corn cob bio-adsorbents, no research to date has described the potential of the two agro-wastes when used together. Sugarcane bagasse and corn cob have different properties that play to their advantages separately, but it is unknown whether these properties would

Table 1
Adsorbent Formulation Details

Adsorbent Name	Experiment Labels	Adsorbent Formulation	Corn Cob (g)	Sugarcane Bagasse (g)	Total (g)
F1	SB	100% S. Bagasse	0	1	1
F2	3B – 1C	75% S. Bagasse, 25% C. Cob	0.25	0.75	1
F3	1B – 1C	50% S. Bagasse, 50% C. Cob	0.5	0.5	1
F4	1B – 3C	25% S. Bagasse, 75% C. Cob	0.75	0.25	1
F5	CC	100% C. Cob	1	0	1

Table 1 summarizes the specific details about the adsorbents placed in each

interact constructively—leading to an increase in their capability to adsorb oil—or not. Additionally, both materials are the main underutilized agro-wastes of the Philippines and can be accessed easily due to the Philippines’ large market for sugar and corn (Cajes, 2013; Baconguis and Pasagdan, 2013). Hence, this study aimed to identify whether a combination of bagasse and corn cob may increase Oil Sorption Capacity. It also aimed to determine what kind of formulation can serve as the most efficient adsorbent, which is the adsorbent with the highest oil sorption capacity and lowest water sorption capacity.

2. METHODOLOGY

2.1. Materials

For the adsorbents, corn cobs were collected from fresh yellow corn bought from Biñan City Market. These collected corn cobs were used in natura or “in their natural state,” only dried to eliminate moisture. The researchers collected sugarcane bagasse from “Tubo ko,” a sugarcane juice stall in SM Sta. Rosa, also in natura.

Used motor oil, the adsorbate, was sourced from a mechanic shop from Santa Rosa, Laguna. Only one source vehicle for the used motor oil was used for consistency. The study used a synthetic blend motor oil with an oil grade of SAE 20W-40, which is one of the primary motor oil grades sold in the Philippines, and the oil grade available to the researchers.

2.2. Procedure

All sugarcane bagasse and corn cobs were thoroughly rinsed and washed with distilled water (Gorgulho et al., 2018) to get rid of impurities. They were cut with a thickness between 0.5 to 1.0 cm (Choi, 2018) and sun-dried for 24 hours. Afterwards, the adsorbents were weighed on a weighing scale and dried in an oven at 110°C for 2 hours. The measuring and drying processes were repeated until the adsorbents’ mass plateaued and were brittle enough to be powdered (Ascutia et al., 2015). The dried sugarcane bagasse and corn cobs were reduced separately using a ceramic mortar and pestle, as

adapted from Ascutia et al. (2015). A blender was used to process the dried materials further, and they were sieved separately using 24-mesh and 28-mesh sieves. Particles within the -24 +28 mesh range were used for the experiment.

Table 1
Adsorbent Formulation Details

Adsorbent Name	Experiment Labels	Adsorbent Formulation	Corn Cob (g)	Sugarcane Bagasse (g)	Total (g)
F1	SB	100% S. Bagasse	0	1	1
F2	3B – 1C	75% S. Bagasse, 25% C. Cob	0.25	0.75	1
F3	1B – 1C	50% S. Bagasse, 50% C. Cob	0.5	0.5	1
F4	1B – 3C	25% S. Bagasse, 75% C. Cob	0.75	0.25	1
F5	CC	100% C. Cob	1	0	1

Table 1 summarizes the specific details about the adsorbents placed in each container. Labels were used in conducting the experiment, where SB labels referred to F1, 3B-1C labels referred to F2, 1B-1C labels referred to F3, 1B-3C pertained to F4, and CC pertained to F5. This correspondence is shown in Table 1.



Figure 1. *Initial mixture set-up*

The experiment had three trials. The researchers poured 200 milliliters (mL) of distilled water and 3 grams (g) of used motor oil in each of the five glass containers for each trial, then were left for 30 minutes to allow the oil to spread more evenly on the water. This set-up is shown in Figure 1.

Formulations with mixed materials were mixed thoroughly after weighing the necessary components. After weighing all adsorbents accurately, they were placed onto the oil in the mixture evenly and were left in contact for four hours.

The adsorbents were recovered from the containers using a surgical scalpel and were placed

directly onto the filter paper by wiping then weighed. The containers were placed beside a bag of desiccants and covered for drying. Once the mass did not change for at least 24 hours, the adsorbents were weighed to get the final mass.

2.3. Research Design

The study used an experimental research design with the five manipulated bio-adsorbent formulations as the independent variable and the Oil Sorption Capacity (OSC) as the dependent variable. The controlled variables were the amount and type of motor oil and water used in each container and the bio-adsorbents' initial mass.

2.4 Data Analysis Strategy

In determining the amount of oil adsorbed (A_{oil}) and water absorbed (A_{water}), calculations using the following formulas were used:

$$A_{oil} = M_f - M_i = (R_f - (C_{cont} + C_{paper})) - M_i$$

$$A_{water} = M_w - M_f = (R_w - (C_{cont} + C_{paper})) - M_i$$

where M_i is the initial mass of the adsorbents before placing in the mixture, the mass of the recovered adsorbents before drying is M_w , and M_f is their mass after drying. M_f and M_w are derived from raw data (which are C_{cont} , C_{paper} , R_w , and R_f). C_{cont} is the mass of the clean, empty recovery container. C_{paper} is the mass of the clean filter paper. The mass of the recovery container, filter paper, and recovered adsorbent before drying is denoted as R_w , and their mass after drying is R_f . The average amount of oil adsorbed and water absorbed of all adsorbent formulations were compared.

The oil sorption capacity (OSC), denoted by Q , was computed using the following formula adapted from Choi (2018)

$$Q = \frac{M_f - M_i}{M_i}$$

M_f is the final mass of the recovered adsorbent after drying, and M_i is the adsorbent's initial mass before it was immersed in the oil-water mixture. However, OSC was expressed as a rate in % for this study by multiplying Q by 100. This formula measured how much oil the adsorbent can adsorb with respect to the adsorbent's initial mass. OSC values greater than 100% mean that the mass of oil adsorbed exceeded the initial mass of the bio-adsorbent before usage.

One-way analysis of variance (ANOVA) was employed to identify any differences in the mean OSCs and water sorption amounts. Tukey's HSD post hoc test was used to determine which adsorbent formulations differed if the one-way ANOVA test indicated an existing difference.



Figure 2. Set-ups after placement of bio-adsorbents F5 (left) and F1 (right)



Figure 3. Set-ups after placement of bio-adsorbents F2 (left), F3 (middle), and F4 (right)

3. RESULTS AND DISCUSSION

3.1 Documentation



Figure 4. F1 bio-adsorbent, after 4 hours contact time



Figure 5. F2 bio-adsorbent, after 4 hours contact time



Figure 6. F3 bio-adsorbent, after 4 hours contact time

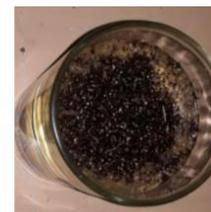

Figure 7. F4 bio-adsorbent, after 4 hours contact time



Figure 8. F5 bio-adsorbent, after 4 hours contact time

3.2. Oil Sorption Capacity

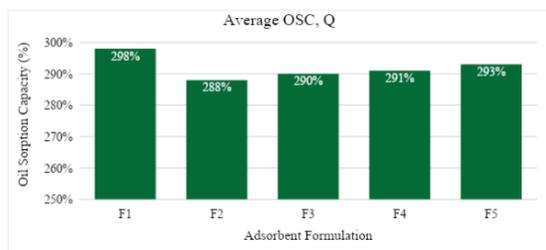

Figure 9. Average oil sorption capacity by all bio-adsorbent formulations

The mean OSC in % of the bio-adsorbents ranged from 288% to 298%. F1 showed the highest, and F2 had the lowest OSC, as illustrated in Figure 9. F3, F4, and F5 showed OSCs of 290%, 291% and 293%, respectively. The slight drop of F2's mean OSC from F1 and the upward trend of mean OSC starting from F2 until F5 may hint that the adsorption mechanism of corn cob and bagasse particles may be opposing each other. However, their values were relatively too close to each other for such a conclusion to be drawn.

One-way analysis of variance was conducted to identify any significant differences among the mean oil sorption capacity values. However, at $\alpha = 0.05$, results showed no statistically significant differences [$F(4,10) = 1.78, p = 0.210$]. This result signifies that all five bio-adsorbent formulations had similar mean OSCs. No further post hoc analyses were conducted since all group mean OSCs were found to be statistically equal.

3.3. Water Sorption and Total Sorption

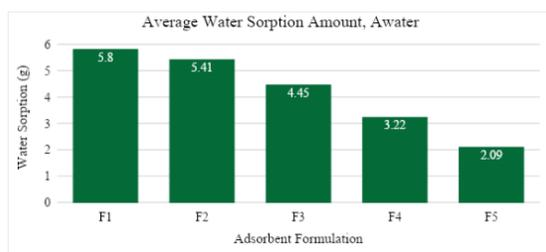
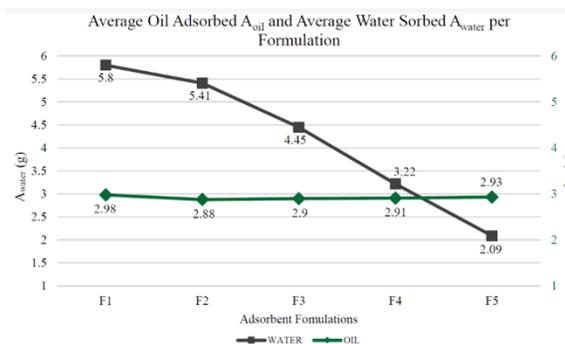

Figure 10. Average water sorption amount by all bio-adsorbent formulations

The mean water sorption amounts exhibited by all bio-adsorbent formulations ranged from 2.09 grams to 5.80 grams, as the graph of water amount sorbed in Figure 10 illustrates. The values followed a downward linear trend from F1 to F5. F1 sorbed an average of 5.80 grams of water, F2 sorbed 5.41 grams, F3 sorbed 4.45 grams, F4 sorbed 3.22 grams, and F5 sorbed only 2.09 grams of water.



As shown in Figures 10 and 11, this declining trend in water sorption indicates that an increasing proportion of bagasse in the bio-adsorbent formulation leads to higher water sorption. This trend showed the higher hydrophilicity of sugarcane bagasse, as discussed by Gorgulho et al. (2018) and Guilharduci et al. (2017). Consequently, formulations that contained more corn cob particles by mass sorbed less water. This observation was also reported by Choi (2018) in her paper, stating that corn cobs are less attracted to water than other agricultural wastes due to their lower hydroxyl action.

Upon employing one-way analysis of variance to see any significant differences among the mean water sorption amounts, at $\alpha = 0.05$, it was shown that there were indeed significant differences in the five group means [$F(4,10) = 23.40, p = 0.000046$]. Upon conducting Tukey's HSD as the post hoc test, results showed that the water sorption of F4 was significantly lower than those of F1 and F2. The mean water sorption of F5 was also shown to be lower than those of F1, F2, and F3. These results signify that, in general, formulations F4 and F5 had significantly lower water sorption amounts, one of the characteristics of an ideal oil bio-adsorbent. Considering that all bio-adsorbents had similar oil sorption capacities, these two formulations can then have more efficiency in adsorbing oil, especially in larger scales of oil spill cleanup.

4. CONCLUSIONS

4.1 Summary of Findings

The average OSCs of all bio-adsorbent formulations ranged from 288% to 298%, where F1 achieved the highest and F2 had the lowest with 288%. Upon conducting one-way analysis of variance on the five bio-adsorbent formulations (at $\alpha = 0.05$), it was found that there were no statistically significant differences in the mean OSCs among all formulations. For the water sorption amount, there was a downward trend from F1 with the highest water sorbed of 5.80 grams, where it decreased from then on with F5 as the lowest (2.09 grams). These findings point to the higher



hydrophobicity of corn cob particles and higher hydrophilicity of bagasse. Upon conducting a one-way analysis of variance (at $\alpha = 0.05$), it was shown that at least one pair of formulations had significant differences between their mean water sorption amounts. Therefore, using Tukey's HSD as the post hoc test, it was shown that, in general, F4 and F5 formulations had significantly lesser water sorption amounts compared to the F1, F2, and F3 formulations.

4.2 Conclusions and Recommendations

This study explored the novel idea of combining sugarcane bagasse and corn cob to create an effective bio-adsorbent and hypothesized that at least one bio-adsorbent formulation would have a differing mean oil sorption capacity, as well as for water sorption amount.

Results indicated that the mean OSCs of all bio-adsorbent formulations are relatively similar in effectiveness when adsorbing oil. Additionally, upon statistical analysis, it was also proven that there are no significant differences between the mean OSCs.

Statistical analysis proved that there are indeed significant differences between the water sorption of F4 and F5 formulations with a lower amount than F1, F2, and F3 formulations. Thus, F4 and F5 have different mean water sorption amounts than the rest.

Because of their similar OSCs, all formulations have great potential in adsorbing oil and can be used for oil spill cleanup. However, since lower water sorption indicates more efficiency for exhibiting greater selective attraction to oil, F4 and F5 can be more efficient than the rest.

The ideal interaction from all mixed bio-adsorbents was exhibited by the F4 formulation, which had the highest mean OSC among all mixed bio-adsorbents while having one of the lowest water amount sorbed. These characteristics shown by bio-adsorbent formulation F4, as well as F5, are the ideal attributes of an oil bio-adsorbent. In general, for a larger scale oil-adsorption, formulations F4 and F5 may be a better choice than the rest due to less attraction to water and a better exhibition of selective attraction to oil. Regardless, corn cob and sugarcane bagasse can be used as effective bio-adsorbents without chemical treatment and may be used interchangeably or in conjunction with each other for any oil spill cleanup applications, without compromise in their oil sorption capacity.

It is recommended for future researchers to delve into other formulations to analyze the interactions between sugarcane bagasse and corn cobs. Additionally, further studies can emphasize different oil concentrations in the oil-water mixture. This recommendation also brings the possible need to standardize the oil-sorbent ratios in sorbent testing.

Lastly, future research may also focus on exploring the influence of contact times on a sorbent's OSC and its tendency to sink.

5. ACKNOWLEDGMENTS

We want to extend our deepest gratitude to Ms. Whenn G. Peña for her unwavering support, encouragement, and guidance throughout this study as our research adviser, and her supervision towards the completion of this paper. We also want to thank Ms. Leah Madrazo for her constant assistance as our Practical Research mentor. The researchers would also like to thank Ms. Patricia Hugo and Mr. Alex Ymson for their significant contributions in collecting the materials needed for the study. Lastly, we would like to thank all our friends and families for being our constant pillars of reassurance and perseverance and helping us finish this research paper.

6. REFERENCES

- Al-Jammal, N. & Juzsakova, T. (2017). *Review on the effectiveness of adsorbent materials in oil spills clean up*, 7th International Conference of ICEEE, Hungary, 2016. https://www.researchgate.net/publication/319254182_Review_on_the_Effectiveness_of_Adsorbent_Materials_in_Oil_Spills_Clean_Up/link/5a8020c80f7e9be137c7bd72/download
- Ascutia, M., Gamboa, R., Mariano, L., Narvas, N., Perez, F., Solis, M., & Lampitoc, R. (2015). Effectiveness of sugarcane bagasse in the biosorption of lead (Pb^{2+}) in wastewater: A preliminary study. *ANTORCHA*, 2(1 and 2), 1.
- Baconguis, S. & Pasagdan, A. (2013). Waste biomass statistics in the Philippines. *Canopy International*, 39(2013): 8–10.
- Behnood, R., Anvaripour, B., Jaafarzadeh, N., & Farasati, M. (2016). Oil spill sorption using raw and acetylated sugarcane bagasse. *J. Cent. South Univ.*, 23, 1618–1625. <https://doi.org/10.1007/s11771-016-3216-8>
- Cajes, A. (2013). *Philippine waste agricultural biomass: Prospects and opportunities*, Workshop on Waste Agricultural Biomass to Energy in South East Asia. UNEP-International Environmental Technology Centre, Cambodia
- Choi, H. J. (2018). Agricultural bio-waste for adsorptive removal of crude oil in aqueous solution. *Journal of Material Cycles and Waste Management*, 21(2), 356-364.
- Crini, G., Lichtfouse, E., Wilson, L., & Morin-Crini, N. (2018). Adsorption-oriented processes using conventional and non-conventional adsorbents for wastewater treatment. In G. Crini & E. Lichtfouse (Eds.), *Green Adsorbents for Pollutant*



Removal, Environmental Chemistry for a Sustainable World 18. Springer (pp. 23-71).
doi.org/10.1007/978-3-319-92111-2_2

Gorgulho, H. de F., Guilharduci, V. V. da S., & Martelli, P. B. (2018). Sugarcane bagasse as potentially low-cost biosorbent. *Sugarcane - Technology and Research*.
doi:10.5772/intechopen.72153

Guilharduci, V. V. D. S., Martelli, P. B., & Gorgulho, H. D. F. (2017). Efficiency of sugarcane bagasse-based sorbents for oil removal from engine washing wastewater. *Water Science and Technology*, 75(1), 173-181.

National Oceanic and Atmospheric Administration. (2019). *How does oil impact marine life?*.
<https://oceanservice.noaa.gov/facts/oilimpacts.html>



Systematic Mapping on Adsorption Studies Using Spent Coffee Grounds

Therese Jan E. Mangussad, Frence Laurice Ghayle A. Nuñez,
and Isadelle Jean E. Topacio
De La Salle University Integrated School, Manila

Dr. Arnel B. Beltran, *Adviser*
De La Salle University, Manila

Abstract: The increase in demand of coffee in the Philippines, led to the increase of production of spent coffee grounds (SCG) waste; utilization of this material is crucial as SCG pose environmental hazards. To evaluate the adsorbent capability of SCG, this study utilized systematic mapping. Research questions that were defined are as follows: 1) What is the research trend on adsorption studies using SCG? 2) What are the processes utilized to produce adsorbent from SCG? 3) What are the different contaminants adsorbed using SCG? 4) What are the important characterizations and performance of SCG adsorbents? It was determined that SCG undergoes various processes such as drying, carbonization, and physical and chemical activation to convert its structure to porous material with a high surface area of up to 2785 m²/g. Furthermore, it was used to adsorb various contaminants such as heavy metals, dyes, and pharmaceuticals with adsorption capacity and removal efficiency of up to 1222.5 mg/g and 100%, respectively. It was also determined that various factors affect adsorption capacity and removal efficiency, namely pH level, adsorbent dosage, initial concentration, and contact time depending on the contaminant. With these, the potentials of SCG as raw material for adsorbent production were found beneficial to reduce its disposal to landfills.

Key Words: spent coffee grounds; adsorption; systematic mapping; valorization

1. INTRODUCTION

Aside from the beverage industry, pharmaceuticals and cosmetics industry also utilize coffee products, making it the third most consumed product next to water and tea, and the second most traded commodity next to petroleum (Szenzthe, 2020). Consequently, global coffee production reached 163.7 million 60-kilogram bags in the year 2019-2020 (Shahbandeh, 2021). The Philippines alone produced 210 thousand 60-kg coffee bags in 2019 (International Coffee Organization, 2020). As a consequence of this big market, approximately 6 million tons of SCG are generated yearly all around the world (Ballesteros et al., 2014; Getachew & Chun, 2017). SCG left off in dumpsites gradually produces methane gas which contributes to the depletion of the ozone layer that protects the planet from excessive ultraviolet rays (Crumbley, 2009). Thus, there is a need to valorize such waste and devise sustainable ways to protect the environment.

Several researchers have investigated the various utilizations of SCG. With the use of direct transesterification, H. C. Nguyen et al. (2019) were able to produce biodiesel from SCG. In another study

conducted by (Coelho et al., 2020), polysaccharides extracted from SCG were utilized to produce biopolymeric films. Adsorbents were also derived from SCG to adsorb different known contaminants such as tetracycline and strontium (V.-T. Nguyen et al., 2021; Shin et al., 2021).

In a study conducted by (Shin et al., 2021), magnetic and non-magnetic biochar were derived from SCG to adsorb strontium ions (Sr²⁺). Magnetic biochar was obtained by mixing pre-treated SCG into FeCl₃ • 6H₂O which allows it to become an easily recoverable adsorbent via magnets once the adsorption process is finished. Characterization of both materials exhibited different surface morphological structures and elemental analysis. Magnetic biochar contained traces of Fe, implying that it was successfully impregnated in the SCG, making it magnetic. However, both materials showed no significant difference in their adsorption capacities of Sr²⁺.

Alkaline-modified SCG were utilized in a study conducted by (V.-T. Nguyen et al., 2021) to adsorb tetracycline from aqueous solutions. SCG was impregnated with NaOH then carbonized with N₂ gas. The adsorbent obtained was able to adsorb 113.64

mg/g of tetracycline which is almost three times of the tetracycline adsorbed by untreated SCG (39.22 mg/g).

Several studies in different fields such as medicine, social sciences, and environmental sciences have used systematic mapping to review the research trend about a certain topic or evaluate the performance of a specific material in a certain application. In a study conducted by Tigue et al. (2020), systematic mapping was utilized to review the existing trend on acid mine drainage treatment using geopolymer and permeable reactive barrier. Their systematic mapping approach consisted of five steps namely: Definition of Research Questions, Conduct Search, Screening of Papers, Keywording using Abstracts, and Data Extraction and Mapping. In this study, the aforementioned steps will be adapted and modified to provide a review on the utilization of SCG as an adsorbent using a systematic mapping approach framework. In order to achieve this objective, the following specific objectives are to be addressed:

SO1: To determine the different studies on adsorption utilization of SCG.

SO2: To determine the various processes utilized to produce adsorbent from SCG.

SO3: To identify the different contaminants SCG adsorbent is able to adsorb.

SO4: To identify the different characterization used for the SCG adsorbent.

SO5: To evaluate the performance of SCG as an adsorbent.

This study only focused on adsorbents derived from SCG and data extracted can be utilized to maximize its potential in future research studies. Furthermore, all research articles reviewed were obtained from Scopus only. Also, instead of SCG going into landfills and harming the environment, it can be further utilized and processed as an adsorbent to remove different known contaminants in wastewaters.

2. METHODOLOGY

In order to provide an organized review of the current findings on adsorption studies using SCG as a precursor for adsorbents, systematic mapping was utilized. Figure 2.1 illustrates the steps that were adapted and modified from the study of Tigue et al. (2020). All steps were followed asides from keywording, which was incorporated in the data extraction and mapping step.

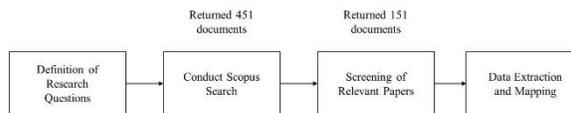

Figure 2.1. *Systematic Mapping Process*

2.1. Definition of Research Questions

The first step in this systematic process is the definition of research questions. Four research questions were synthesized to guide the whole systematic process as presented below.

These will aid in providing an overview of the studies through the relevant information and details present in every study.

RQ1: What is the research trend on adsorption studies using SCG?

RQ2: What are the processes utilized to produce adsorbent from SCG?

RQ3: What are the different contaminants adsorbed using SCG?

RQ4: What are the important characterizations and performance of SCG adsorbents?

2.2. Conduct Scopus Search

Scopus was used to gather the articles relevant to this study. A search string (TITLE-ABS-KEY (coffee AND grounds)) AND (adsorption) was defined to limit the results for the search process. Adsorption studies that utilized SCG were considered in the relevant searches.

2.3. Screening of Relevant Papers

Important information from the studies obtained were examined in screening of relevant papers. These information are mainly observed in the title, abstract, and keywords present in the study. The papers obtained were tabulated in spreadsheet format to present the extracted information in an organized manner. As can be seen in Figure 2.2, details such as title of publication, date of publication, authors, journal name, general utilization, and specific utilization were initially obtained and placed in a spreadsheet.

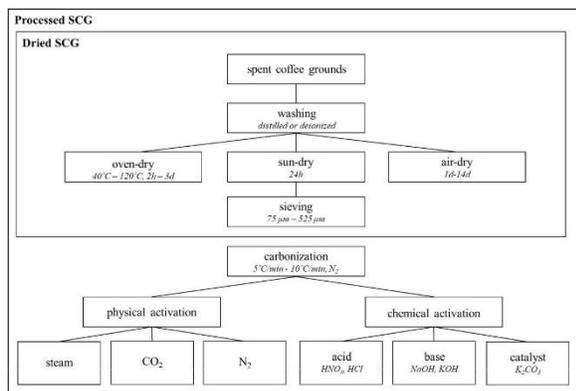

Figure 3.2. Flow Diagram for Preparation of Adsorbents from SCG

3.3. Contaminants Adsorbed by SCG Adsorbents

Figure 3.3 illustrates the corresponding percentage of papers published based on the contaminant SCG was able to adsorb. Some of the contaminants under the “Others” category are ozone, BTEX, crude oil, and livestock wastewater pollutants (Acosta et al., 2021; Hsieh & Wen, 2020; Huang et al., 2021; Sangpongchai & Prueksasit, 2017).

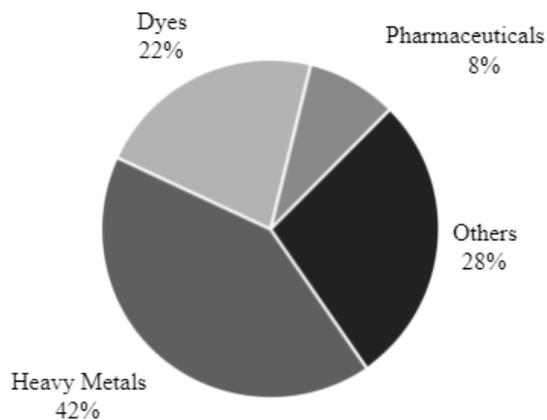

Figure 3.3. Contaminants Adsorbed by SCG

3.4. Important Characterizations of SCG Adsorbents

As SCG undergo various processes to derive adsorbent from it, characterization tests such as BET, Elemental Analysis, SEM, and FT-IR are conducted to verify if the processes were successful in producing an adsorbent. Seen in Table 3.1 are the range of values obtained for the different characterization tests conducted on adsorbents derived from SCG.

Table 3.1. Important Characteristics of SCG Adsorbents

Characterization	Range of Values
Surface Area (m ² /g)	0.047 – 2785
Pore Volume (cm ³ /g)	0.00935 – 14.2
Pore Size (nm)	0.6– 520
Composition	
%C	30.59 – 99.64
%H	0.8– 18.56
%O	0.23 – 64.11
%N	0.8– 21.69

Characterization	Range of Values
%Ash	1.8 – 37.7
SEM magnification (x)	40 – 50000
FT-IR (cm ⁻¹)	
C-H	630 – 3472
C-O	900 – 1741
O-H	613 – 3890

3.5. Performance of SCG as an Adsorbent

Heavy Metals

Figure 3.4 illustrates the adsorption capacity of SCG of heavy metals ranging from 0.657 mg/g up to 251.71 mg/g (Seniūnaite et al., 2018; Song et al., 2019). The removal efficiency, on the other hand, ranges from 60% to 100% as can be seen in Figure 3.5. Copper and zinc presented low removal efficiency of 18% and 9% respectively (Jutakrudsada et al., 2016; Sertoli et al., 2019).

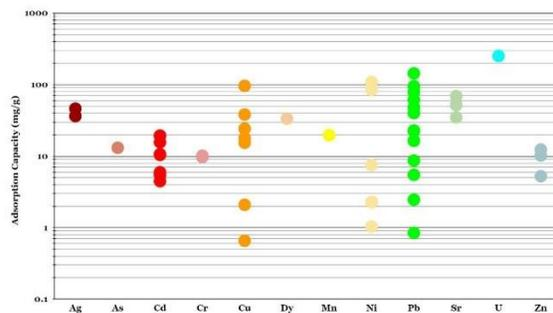

Figure 3.4. Heavy Metals Adsorption Capacity of SCG

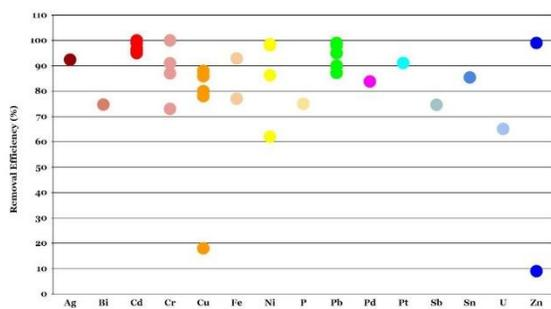

Figure 3.5. Heavy Metals Removal Efficiency of SCG

Dyes

As can be seen in Figure 3.6, the highest adsorption capacity exhibited by SCG is on an Anionic Azo Dye at 1222.5 mg/g (Jung et al., 2017) followed by methylene blue and acid orange 7 at 986.8 mg/g and 665.9 mg/g respectively (Jung et al., 2016). Moreover, Figure 3.7 illustrates that removal efficiency for dyes are all at least 80%.

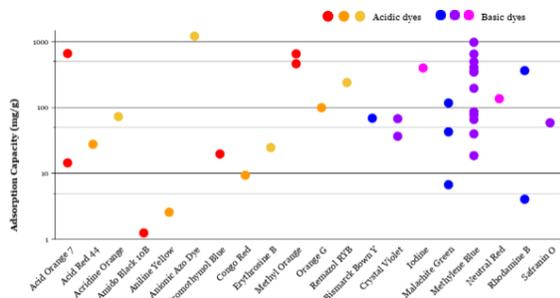

Figure 3.6. Dyes Adsorption Capacity of SCG

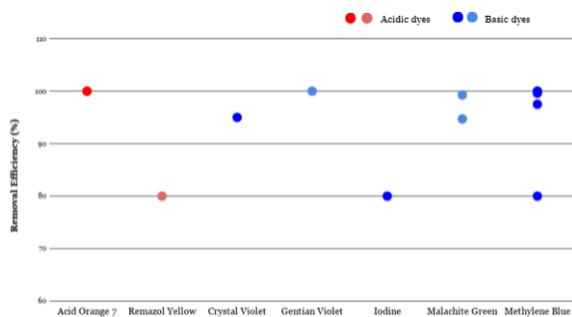

Figure 3.7. Dyes Removal Efficiency of SCG

Figure 3.7. Dyes Removal Efficiency of SCG

Pharmaceuticals

Based on the extracted data, pharmaceutical contaminants are the least explored in terms of using SCG as an adsorbent. Hence, as shown in Figure 3.8, the not very high adsorption capacity ranging from 5.5774 mg/g up to 370.37 mg/g as compared to heavy metals and dyes (V.-T. Nguyen, Nguyen, Chen, Hung, Huang, et al., 2019; Pavlović et al., 2015). It also

exhibited a removal efficiency of 90%, 55%, and 96% for diclofenac, sulfamethoxazole, and tetracycline respectively (Lazarotto et al., 2020; Lykoudi et al., 2020; V.-T. Nguyen, Nguyen, Chen, Hung, Vo, et al., 2019). This also implies that there is more to explore in using SCG as an adsorbent for pharmaceutical contaminants.

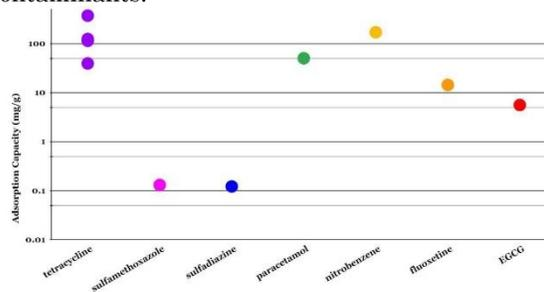

Figure 3.8. Pharmaceuticals Adsorption Capacity of SCG

4. CONCLUSION

This study has reviewed the potential of SCG as an adsorbent to many known contaminants of the environment. The results show that adsorption studies using SCG as a precursor for adsorbent have slowly been building up through the years and have recently gained more attention. It was found that as SCG contains high carbon content (58.5%), hence it undergoes processes such as drying, carbonization, and chemical and physical activation that will allow it to develop porous structures and high surface areas of up to 2785 m²/g which are essential for adsorption. In addition, adsorbents derived from SCG are able to adsorb contaminants with adsorption capacity and removal efficiency of 1222.5 mg/g and 100%, respectively. These include heavy metals, dyes, and pharmaceuticals, all of which pose a hazard to the environment. Moreover, the data extracted and summarized from different studies can be utilized to maximize the potential of SCG as an adsorbent in future research studies. As this study was limited to 151 papers, more databases aside from Scopus can be explored to obtain more research papers that will undergo systematic review. This will give a wider overview of the current findings on SCG as an adsorbent to different known contaminants.

5. ACKNOWLEDGMENTS

The completion of this research paper would not have been possible without the help of various people. The researchers express their utmost gratitude to the following people for their endless support and guidance.

To their Research Adviser, Dr. Arnel B. Beltran, for ensuring that the progress of the research



paper is going on the right track. Also, for sharing his expertise in the field of Chemical Engineering by meticulously checking their paper to give his comments and suggestions.

To their Practical Research Professors, Dr. Ethel Ong and Dr. Alan Soriano, for their determination in teaching them how to write a research paper efficiently and coherently, and for teaching the importance of intellectual honesty.

To their STEM Research Coordinator, Ms. Liezl Rillera-Astudillo, for her patience in answering all inquiries related to Practical Research course. Also, for never failing to give them updates and announcements.

To the researchers' parents for their unconditional love and for always being ready to give their assistance with whatever is needed.

And above all, to the Almighty God, the all-knowing Father, for His wisdom and guidance during the duration of this project.

6. REFERENCES

- Acosta, L., Galeano-Caro, D., Medina, O. E., Cortés, F. B., & Franco, C. A. (2021). Nano-intermediate of magnetite nanoparticles supported on activated carbon from spent coffee grounds for treatment of wastewater from oil industry and energy production. *Processes*, 9(1), 1–21. <https://doi.org/10.3390/pr9010063>
- Alcaraz, L., Escudero, M. E., Alguacil, F. J., Llorente, I., Urbieto, A., Fernández, P., & López, F. A. (2019). Dysprosium removal from water using active carbons obtained from spent coffee ground. *Nanomaterials*, 9(10). <https://doi.org/10.3390/nano9101372>
- Ballesteros, L. F., Teixeira, J. A., & Mussatto, S. I. (2014). Chemical, Functional, and Structural Properties of Spent Coffee Grounds and Coffee Silverskin. *Food and Bioprocess Technology*, 7(12), 3493–3503. <https://doi.org/10.1007/s11947-014-1349-z>
- Benyekkou, N., Ghezzar, M. R., Abdelmalek, F., & Addou, A. (2020). Elimination of paracetamol from water by a spent coffee grounds biomaterial. *Environmental Nanotechnology, Monitoring and Management*, 14. <https://doi.org/10.1016/j.enmm.2020.100396>
- Coelho, G. O., Batista, M. J. A., Ávila, A. F., Franca, A. S., & Oliveira, L. S. (2020). Development and characterization of biopolymeric films of galactomannans recovered from spent coffee grounds. *Journal of Food Engineering*, 289, 110083. <https://doi.org/10.1016/j.jfoodeng.2020.110083>
- Crumbly, L. (2009). Climate for Action: New Uses for Used Coffee Grounds. The EPA Blog. <https://blog.epa.gov/2009/02/24/climate-for-action/>
- Getachew, A. T., & Chun, B. S. (2017). Influence of pretreatment and modifiers on subcritical water liquefaction of spent coffee grounds: A green waste valorization approach. *Journal of Cleaner Production*, 142, 3719–3727. <https://doi.org/10.1016/j.jclepro.2016.10.096>
- Hsieh, P.-F., & Wen, T.-Y. (2020). Evaluation of Ozone Removal by Spent Coffee Grounds. *Scientific Reports*, 10(1). <https://doi.org/10.1038/s41598-019-56668-5>
- Huong, T. T. T., Van Hoang, N., Ngoc Toan, V., Tong, N. X., Quan, T. A., & Thu, V. K. (2021). Initial Results of Using Biochar Derived from Spent Coffee Grounds to Remove Pollutants from Livestock Wastewater in Vietnam. In *Lecture Notes in Civil Engineering* (Vol. 108). https://doi.org/10.1007/978-3-030-60269-7_16
- International Coffee Organization. (2020). Total production by all exporting countries. <http://www.ico.org/prices/production.pdf>
- Jung, K.-W., Choi, B. H., Hwang, M.-J., Choi, J.-W., Lee, S.-H., Chang, J.-S., & Ahn, K.-H. (2017). Adsorptive removal of anionic azo dye from aqueous solution using activated carbon derived from extracted coffee residues. *Journal of Cleaner Production*, 166, 360–368. <https://doi.org/10.1016/j.jclepro.2017.08.045>
- Jung, K.-W., Choi, B. H., Hwang, M.-J., Jeong, T.-U., & Ahn, K.-H. (2016). Fabrication of granular activated carbons derived from spent coffee grounds by entrapment in calcium alginate beads for adsorption of acid orange 7 and methylene blue. *Bioresource Technology*, 219, 185–195. <https://doi.org/10.1016/j.biortech.2016.07.098>
- Jutakradsada, P., Prajaksud, C., Kuboonya-Aruk, L., Theerakulpisut, S., & Kamwilaisak, K. (2016). Adsorption characteristics of activated carbon prepared from spent ground coffee. *Clean Technologies and Environmental Policy*, 18(3), 639–645. <https://doi.org/10.1007/s10098-015-1083-x>
- Kang, H., Choi, S., Lee, J. H., Kim, K.-T., Song, Y.-H., & Lee, D. H. (2020). Plasma jet assisted carbonization and activation of coffee ground waste. *Environment International*, 145. <https://doi.org/10.1016/j.envint.2020.106113>
- Lazarotto, J. S., de Lima Brombilla, V., Silvestri, S., & Foletto, E. L. (2020). Conversion of spent coffee grounds to biochar as promising TiO₂ support for effective degradation of diclofenac in water. *Applied Organometallic Chemistry*, 34(12). <https://doi.org/10.1002/aoc.6001>
- Loffredo, E., & Taskin, E. (2017). Adsorptive removal of ascertained and suspected endocrine disruptors from aqueous solution using plant-derived materials. *Environmental Science and Pollution Research*, 24(23), 19159–19166. <https://doi.org/10.1007/s11356-017-9595-z>
- Lykoudi, A., Frontistis, Z., Vakros, J., Manariotis, I. D., & Mantzavinos, D. (2020). Degradation of sulfamethoxazole with persulfate using spent coffee grounds biochar as activator. *Journal of Environmental Management*, 271. <https://doi.org/10.1016/j.jenvman.2020.111022>
- Nguyen, H. C., Nguyen, M. L., Wang, F. M., Liang, S. H., Bui, T. L., Ha, H. H., & Su, C. H. (2019). Using switchable solvent as a solvent and catalyst for in situ transesterification of spent coffee grounds for biodiesel synthesis. *Bioresource Technology*, 289, 121770. <https://doi.org/10.1016/j.biortech.2019.121770>



- Nguyen, V.-T., Nguyen, T.-B., Chen, C.-W., Hung, C.-M., Huang, C. P., & Dong, C.-D. (2019). Cobalt-impregnated biochar (Co-SCG) for heterogeneous activation of peroxymonosulfate for removal of tetracycline in water. *Bioresource Technology*, 292. <https://doi.org/10.1016/j.biortech.2019.121954>
- Nguyen, V.-T., Nguyen, T.-B., Chen, C.-W., Hung, C.-M., Vo, T.-D.-H., Chang, J.-H., & Dong, C.-D. (2019). Influence of pyrolysis temperature on polycyclic aromatic hydrocarbons production and tetracycline adsorption behavior of biochar derived from spent coffee ground. *Bioresource Technology*, 284, 197–203. <https://doi.org/10.1016/j.biortech.2019.03.096>
- Nguyen, V.-T., Nguyen, T.-B., Huang, C. P., Chen, C.-W., Bui, X.-T., & Dong, C.-D. (2021). Alkaline modified biochar derived from spent coffee ground for removal of tetracycline from aqueous solutions. *Journal of Water Process Engineering*, 40. <https://doi.org/10.1016/j.jwpe.2020.101908>
- Pavlović, M. D., Buntić, A. V., Šiler-Marinković, S. S., Antonović, D. G., & Dimitrijević-Branković, S. I. (2015). Recovery of (–)-epigallocatechingallate (EGCG) from aqueous solution by selective adsorption onto spent coffee grounds. *European Food Research and Technology*, 241(3), 399–412. <https://doi.org/10.1007/s00217-015-2472-4>
- Pujol, D., Liu, C., Gominho, J., Olivella, M. À., Fiol, N., Villaescusa, I., & Pereira, H. (2013). The chemical composition of exhausted coffee waste. *Industrial Crops and Products*, 50, 423–429. <https://doi.org/10.1016/j.indcrop.2013.07.056>
- Sangpongchai, S., & Prueksasit, T. (2017). Adsorption efficiency of the activated charcoal produced from spent coffee ground for removal of the BTEX released from indoor paint. *EnvironmentAsia*, 10(1), 99–108. <https://doi.org/10.14456/ea.2017.12>
- Seniūnaite, J., Vaiškūnaite, R., & Paliulis, D. (2018). Coffee grounds as low-cost adsorbent for the removal of copper (II) and lead (II) from aqueous solutions. *Bulgarian Chemical Communications*, 50(1), 74–81.
- Sertoli, L., Carnier, R., de Abreu, C. A., Coscione, A. R., & Melo, L. C. A. (2019). Coffee waste biochars: Characterization and zinc adsorption from aqueous solution. *Coffee Science*, 14(4), 518–529. <https://doi.org/10.25186/cs.v14i4.1634>
- Shahbandeh, M. (2021). Coffee market: worldwide production 2003/04-2019/20. Statista. <https://www.statista.com/statistics/263311/worldwide-production-of-coffee/#statisticContainer>
- Shin, J., Lee, Y.-G., Kwak, J., Kim, S., Lee, S.-H., Park, Y., Lee, S.-D., & Chon, K. (2021). Adsorption of radioactive strontium by pristine and magnetic biochars derived from spent coffee grounds. *Journal of Environmental Chemical Engineering*, 9(2). <https://doi.org/10.1016/j.jece.2021.105119>
- Song, S., Gu, P., Chen, Z., Wang, X., Zhang, R., & Wen, T. (2019). Removal of U(VI) by acid-oxidized biochar: Batch experiments and spectroscopy study. *Scientia Sinica Chimica*, 49(1), 155–164. <https://doi.org/10.1360/N032018-00143>
- Szente, A. (2020). Top Coffee Producing Countries. World Atlas. <https://www.worldatlas.com/articles/top-coffee-producing-countries.html>
- Tigue, A. A. S., Malenab, R. A. J., & Promentilla, M. A. B. (2020). A Systematic Mapping and Scoping Review on Geopolymer and Permeable Reactive Barrier for Acid Mine Drainage Treatment Research. *Process Integration and Optimization for Sustainability*, 4(1), 15–35. <https://doi.org/10.1007/s41660-020-00105-y>
- Torres-Caban, R., Vega-Olivencia, C. A., & Mina-Camilde, N. (2019). Adsorption of Ni²⁺ and Cd²⁺ from water by calcium Alginate/Spent coffee grounds composite beads. *Applied Sciences (Switzerland)*, 9(21). <https://doi.org/10.3390/app9214531>
- Yuliusman, Nasruddin, Afdhol, M. K., Haris, F., Amiliana, R. A., Hanafi, A., & Ramadhan, I. T. (2017). Production of activated carbon from coffee grounds using chemical and physical activation method. *Advanced Science Letters*, 23(6), 5751–5755. <https://doi.org/10.1166/asl.2017.8822>



Assessing the Technological Maturity of Vegetable Protein-Based Biodegradable Packaging Material Production

Stephanie Red L. Contreras, Jeremy Joseph C. Jimenez, Krizel Ann L. Lagundi
and Kim Russel Q. Llanto
De La Salle University Integrated School, Manila

Abstract: The insurgence of plastic waste has posed a detrimental challenge to the environment. Despite actions taken, the plastic problem persists, giving rise to several other issues affecting life on Earth. One of the identified solutions to avert this is to create a biodegradable alternative that would limit plastic dependency and limit the pressure on the environment. In this paper, the current vegetable protein-based packaging industry was explored. This includes the emergence of biodegradable films, innovations applied in their development, and market adoption barriers. This also considers synthesizing the developed films' pertinent properties as a vital component to knowing whether it satisfies its purpose as intended. From a set of established criteria, a narrative review was conducted on 40 selected published journal articles from the Elsevier-Science Direct database on vegetable protein-based biodegradable packaging (PBBP) material. The findings of the study present a wide range of credible alternatives exhibiting competitive properties. While PBBP is still not at par with conventional plastics, the defined gaps in this sector could be a stepping stone for future studies to focus on developing low-cost methods and materials while giving equal importance to durability and biodegradability, hence, a broader scale for PBBP adoption.

Key Words: plastic alternatives; bioplastic; mechanical properties; plastic pollution

1. INTRODUCTION

Throughout the years, plastics were widely used by society. According to Thompson et al. (2009), plastics are lightweight, durable, corrosion-resistant materials with high thermal and electrical insulation properties, and were given importance due to its versatility and convenience. However, plastics have negatively impacted the environment. Plastic pollution became one of the pressing environmental issues, as its rapid increase in production overwhelms the world's capability to deal with it. The world's plastic production totaled around 359 million metric tons in 2018, where non-biodegradable single-use plastics account for 40 percent (Tiseo, 2021).

In the Philippines, plastic pollution is also rampant. An article by the World Wide Fund for Nature (2018) pointed out the factors causing the enormous amount of plastics: people continuously purchasing in small amounts that resulted in more waste; and improper waste disposal, making the country one of the world's leading plastic polluters. While environmental preservation is a significant task for the government and other environmentally-allied professionals, it is incumbent among all people to be vigilant and concerned about this issue.

To address this problem, biodegradable plastics derived from natural sources that do not contain harmful chemical fillers and quickly break

down were created (Connecticut Plastics, 2020). However, biodegradable plastic production is deemed costly, given the pertinent processes and needed components.

That made the researchers interested in assessing the technological readiness of a plastic alternative, namely vegetable protein-based biodegradable packaging materials, if ready for mass production and utilization, that will take a step further in lessening conventional plastic use. With that, they would highlight and synthesize the recent innovations in PBBP material development and define the impediments that prevent its wider adoption in various industries.

2. METHODOLOGY

The study's design is a narrative review, a type of qualitative research synthesis that analyzes a body of literature with diverse methodologies and theoretical conceptualizations (Baumeister, 2013). It focused on a specific type of plastic alternative, biodegradable protein films.

To narrow down the research scope, a set of criteria was established for the article selection: (1) the film must have a vegetable protein matrix; (2) it must highlight any innovation in components, process, or properties; (3) it must present quantitative data on the mechanical properties; and (4) it must be a journal

article published within the last five years. Although quantitative data is pertinent, the review did not employ the statistical significance of the individual findings.

Data collection was primarily done using the internet. The Elsevier-Science Direct database was mainly utilized as it provides a wide range of bibliographic data regarding biodegradable films. A comprehensive bibliographic search was carried out using the following search string keywords: Biodegradable Packaging Material; Biodegradable Films; Vegetable Proteins; Innovation; and Mechanical Properties, and with publication year ranging from 2015 to 2020. The search results were refined to published journal articles. No books and review articles were included because these do not provide a thorough discussion regarding the studies. A total of forty (40) studies on innovations in PBBP materials were pooled.

An analysis of the collated studies was also conducted. First, the studies were assessed based on the type of innovation and publication year to display the recent trends and characteristics of PBBP research by presenting illustrative representations. Second, the journal articles were sorted per innovation, and salient, emerging themes were identified. A qualitative discussion was imparted to synthesize the studies' findings. Lastly, an analysis of the Strengths, Weaknesses, Opportunities, and Threats (SWOT) of PBBP production was undertaken to display extensive understanding of the industry's internal and external attributes.

3. RESULTS AND DISCUSSION



Fig. 1. Recent innovations on PBBP materials.

The most ventured innovation among the gathered studies, as shown in Figure 1, is the incorporation of bio composite materials as reinforcement and experimentation on film development process. Following those were studies that focused on strengthening mechanical properties and the causation of inhibitory properties as researchers also took note of bacterial infections and food spoilages.

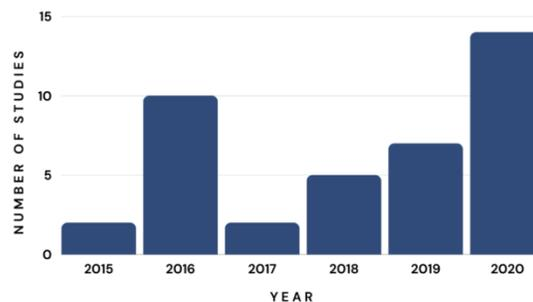

Fig. 2. Pooled studies based on publication year.

Figure 2 shows the collated studies based on publication year from 2015 to 2020, to ensure a synthesis that is relevant in today's context. Out of all 40 gathered studies, 14 were published in 2020, whereas 10 of the studies were published in 2016, as slightly old but still pertinent innovations were considered. Lastly, 5 and 7 studies were from 2018 and 2019, respectively, while 2 studies were published in 2015 and 2017 each.

3.1 Innovations Incorporating Composite Materials

Table 1. Remarkable innovations incorporating composite materials on PBBP.

Vegetable Protein	Incorporated Composite Material	Notable Findings	Reference
Soy	Cellulose nanocrystals (CNCs); pine needle extract (PNE)	The addition of CNCs: <ul style="list-style-type: none"> lowered moisture content; enhanced TS and EAB. The addition of PNE decreased WVP.	Yu et al. (2018)
	Cellulose nanofibers (CNFs)	The addition of 1.0 mL CNFs led to: <ul style="list-style-type: none"> highest TS; higher heat capacity. 	Borela & Apolinar (2020)
Whey	Oat husk nanocellulose (ONC)	The addition of 5 wt% ONC: <ul style="list-style-type: none"> decreased moisture content; decreased WVP by 34%; increased TS by 23%; increased Young's modulus by 47%. 	Qazanfarzadeh & Kadivar (2016)
	Cellulose nanofibers with polymethyl methacrylate (CNF-g-PMMA)	The addition of CNF: <ul style="list-style-type: none"> decreased water permeation by 51-64%; enhanced TS. 	Samadani et al. (2019)
Zein	Pomegranate peel extract (PE) or chitosan nanoparticles (CSNPs)	The addition of CSNPs/PE increased: <ul style="list-style-type: none"> TS; EAB; heat flow. 	Cui et al. (2020)

Note: TS - tensile strength; WVP - water vapor permeability; EAB - elongation at break

Various studies in creating protein-based biodegradable films sought into adding composite materials into the film matrix for reinforcement. The incorporated biocomposites commonly include cellulose fibers, chitosan particles, and plant extracts. The findings of these studies, as shown in Table 1, highlighted improved barrier and mechanical properties, especially moisture content, water vapor permeability, and tensile strength that are usually assessed in biodegradable packaging materials. Hence, the incorporation of composite materials led to enhanced properties of vegetable PBBP films that could springboard future studies that will venture into creating improved biodegradable packaging materials for wider adoption.



3.2 Innovations on Film Development Process

Components	Process	Notable Findings	References
PPI, glyceol	Injection molding	A 70:30, PPI:glyceol ratio, exhibits: <ul style="list-style-type: none"> enhanced elastic bending, TS; ability to absorb mechanical energy before rupturing; fast water uptake capacity. 	Perez et al. (2016)
SPI, cassava starch, stearic & citric acid	Extrusion, thermocompression	A 40:60, cassava starch: SPI ratio, exhibits: <ul style="list-style-type: none"> high maximum TS, water solubility; good WVP and oil permeability. 	Ferreira et al. (2020)
WPI, glycerol	Ultraviolet radiation treatment, heat treatment	The highest dose of UV treatment, 12 J cm ⁻² , increased: <ul style="list-style-type: none"> TS; puncture strength; deformation; elastic modulus. Heat treatment improved the film's functionality.	Diaz et al. (2016)
Zein, chitosan	Cold plasma treatment	Films treated with cold plasma: <ul style="list-style-type: none"> increased barrier properties; enhanced zein and chitosan molecules compatibility. 	Chen et al. (2019)
WPI, carboxymethylated chitosan (CMC)	Transglutaminase (TGase) treatment	WPI-CMC (75:25) film treated with TGase improved: <ul style="list-style-type: none"> WVP; mechanical properties. 	Jiang et al. (2016)

Note: SPI - Soy Protein Isolate; WPI - Whey Protein Isolate; PPI - Pea Protein Isolate; TS - Tensile Strength; WVP - Water Vapor Permeability

Based on the studies, an inhibiting factor for PBBP utilization is the costly and complex processing methods of transforming proteins into biodegradable films. Different processes have been explored, including integrating conventional techniques like injection molding, and extrusion. However, this still requires reinforcement techniques that emanate additional costs. Some of these techniques are shown in Table 2. As indicated, the incorporation of such processes improved the films' properties, enabling them to achieve their packaging function.

3.3 Innovations Strengthening Mechanical Properties

Table 3. Recent innovations strengthening mechanical properties of the films.

Components	Mechanical Properties	Notable Findings	References
SPI, GPTMS, POSS	TS: SPI 33.3 SPI/GPTMS/POSS: 62.1 EAB: SPI 213.5 SPI/GPTMS/POSS: 101.2	Adding GPTMS and POSS increased TS and offset yield strength.	Xia et al. (2016)
SPI, CNC, glycerol	TS: 3.13 to 4.79 EAB: 98.2 to 86.5	Modified film using CNC increased TS by 25%.	Zhang et al. (2016)
Nanocellulose, whey protein isolate, bergamot oil	WPI: EM 15.5 ± 2.2, 2b TS: 19.8 ± 2.5ab E: 14.7 ± 2.7bc WPI:10NC: EM 180.7 ± 20.7b TS: 24 ± 1.8a E: 26.3 ± 8.9ab	Mixing nanocellulose and bergamot oil with WPI enhanced the mechanical resistance and WVP.	Sogut (2020)
SPI, rapeseed oil concentration (ROC)	TS: ROC1: 1.21(0.42) ROC3: 0.91(0.19) YM: ROC1: 0.91(0.29) ROC3: 0.68(0.12) EAB: ROC1: 4.12(0.14) ROC3: 4.18(0.16)	ROC improved WVP. Increasing dosage from 1% to 3% induced favorable mechanical properties.	Gains (2018)
SPI, ZPI	1:1TS: 1.32±0.288 2:1TS: 1.62±0.861 1:1TS: 3.87±0.564	Higher amounts of zein in composite films strengthened its structure.	Tsai & Weng (2020)

Note: SPI - Soy Protein Isolate; TS - Tensile Strength in MPa; EAB - Elongation at Break in %; YM - Young Modulus in MPa;

3.4 Innovations Triggering Inhibitory Properties

Table 4. Notable studies venturing into PBBPs' causation of inhibitory properties.

Components	Method Used	Microbes Tested	Inhibition Zone	References
WPI, water soluble chitosan	Agar Disk Diffusion Method	<i>Aspergillus niger</i>	WPI: ND WSC1: 5%(w/w): 54.17 ^a WSC3: 5%(w/w): 87.50 ^a	Vanden Braber et al. (2020)
		<i>Fusarium sp.</i>	WPI: ND WSC1: 5%(w/w): 52.50 ^a WSC3: 5%(w/w): 52.50 ^a	
		<i>Penicillium roqueforti</i>	WPI: ND WSC1: 5%(w/w): 82.50 ^a WSC3: 5%(w/w): 97.50 ^a	
		<i>Rhizopus sp.</i>	WPI: ND WSC1: 5%(w/w): 52.50 ^a WSC3: 5%(w/w): 97.50 ^a	
WPI, TiO ₂ nanoparticles, cellulose nanofibers (CNFs), rosemary essential oil (REO)	Gram-positive	<i>S. aureus</i>	WPI: CNF: ND	Alizadeh-Sani et al. (2018)
		<i>L. monocytogenes</i>	WPI/TiO ₂ , REO had the most effect	
		<i>E. coli O157:H7</i>	Besides the control, WPI/REO had the least effect	
	Gram-negative	<i>P. fluorescens</i>		

ZPI, cinnamon essential oil (CEO), chitosan nanoparticles (CNP)	Gram-positive <i>S. aureus</i>	<i>S. enteritidis</i>		Vahedikia et al. (2019)	
		zein: ND zein & CNPs: ND zein & CEO: 21.66±0.57 ^a zein, CNPs & CEO: 27.33±1.93 ^b			
Chinese chive extract root, chitosan	Gram-positive	<i>S. aureus</i>	CS ⁵ : 7.13±0.14 ^a CS-CRE1: 10.64±0.21 ^a CS-CRE3: 14.73±0.29 ^a CS-CRE5: 18.12±0.36 ^b	Riaz et al. (2020)	
			<i>B. cereus</i>		CS ⁵ : 6.21±0.12 ^a CS-CRE1: 11.83±0.23 ^a CS-CRE3: 15.39±0.30 ^a CS-CRE5: 18.79±0.37 ^b
	Gram-negative	<i>E. coli</i>		CS ⁵ : 4.43±0.08 ^a CS-CRE1: 7.18±0.14 ^a CS-CRE3: 12.87±0.25 ^a CS-CRE5: 16.21±0.32 ^b	
			<i>S. typhimurium</i>	CS ⁵ : 4.11±0.08 ^a CS-CRE1: 6.87±0.13 ^a CS-CRE3: 11.54±0.23 ^a CS-CRE5: 14.91±0.29 ^a	
	SPI, cortex phenolendron extract	Gram-positive <i>S. aureus</i>		The inhibition zones for <i>S. aureus</i> were larger than for <i>E. coli</i> .	
		Gram-negative <i>E. coli</i>			

Note: WPI - whey protein isolate; SPI - soy protein isolate; ZPI - zein protein isolate; ND - not detected; ^a diameter in mm; ^b diameter in mm²; ^c control group;

Some conducted studies gave attention to the provocation of inhibitory properties, aside from strengthening the mechanical properties in a produced PBBP material. These researchers sought to obtain active packaging films that can help prevent food spoilages or bacterial infection. In doing that, the credibility of the film improved, and as seen in Table 4, said researchers were successful in doing so.

Note: The complete list of innovations is available upon request.



3.5 SWOT Analysis

Table 5. SWOT analysis on the collated studies regarding PBBP films.

Factor	Highlights			
Strengths	Lessened environmental burden	Reduced petroleum consumption	Expanding interest in the field of PBBP	Competitive properties
Weaknesses	Availability of pertinent equipment for production	Innovations further aligned into strengthening mechanical properties	Fastidious environmental conditions	
Opportunities	Environmental consciousness	Unintended benefits	Variety of applications	Business opportunity
Threats	Consumer acceptance	Unpreparedness for mass-market production	Expensiveness of the production process and raw materials	Risk of an environmental crisis due to waste build-up

3.5.1 Strengths

The PBBPs showed biodegradability varying from weeks to months, depending on raw materials added into the formulation, and they were composed of vegetable proteins and other bio-based materials, instead of non-renewable petroleum, which is harmful to the environment. An increase in the number of PBBP-related studies was also observed, mirroring that, people become more engaged and aware of climate change while addressing the sustainability problem. Lastly, promising properties of PBBPs that are not present with conventional plastics are being initiated, like inhibitory properties.

3.5.2 Weaknesses

Some steps in creating PBBP materials require proper treatment of raw materials using certain pieces of equipment that are not usually available for most countries that could be interested in producing PBBPs for market use. Meanwhile, studies usually lean into achieving sufficient mechanical properties and not on the improvement of film biodegradation. That is crucial, for the driving force behind the PBBP creation is producing packaging materials that help address plastic pollution. Regarding biodegradability, some films degrade only in a certain environment, where others require composting facilities that cater to biodegradable packaging waste, while some employ chemical and other degrading techniques.

3.5.3 Opportunities

People start to realize the possible consequences of harmful activities to the environment. Amongst studies exploring PBBP, plastic pollution is the common dilemma motivating researchers to contribute to the existing body of knowledge and create a step towards limiting single-use plastic consumption. Concerning the development of biodegradable films, utilizing by-products like pomegranate and banana peels to reinforce their properties was seen to have an unintended benefit of solving poor waste disposal. Although some films and coatings show appreciable potential in biodegradable packaging production, conducting physical and

chemical modifications may pave the way for market adoption, since people are more inclined to invest in environmentally-sound products nowadays. Producing viable plastic alternatives could become a sustainable market opportunity that both individuals and the environment can benefit from.

3.5.4 Threats

At present, few consumers have knowledge on the existence of PBBP films and its production, which can stem uncertainty, making it difficult to kickstart market consumption of such films. Additionally, due to the assurance that PBBP films can degrade, importance of preferable biodegradation conditions was downplayed, focusing instead on enhancing mechanical properties. As composite manufacturing is a highly specialized field and raw materials are costly, spending high amounts of money is inevitable in the production of composite PBBP films, leading to the question if the product is worth the trouble or not. Lastly, despite the created sustainable solution, the accumulation of PBBP film wastes is still inevitable as biodegradation requires certain conditions. Therefore, if said conditions are not met, that could potentially worsen the condition of the environment.

4. CONCLUSIONS

Over the past five years, innovative research on PBBPs has risen, predominantly on infusing composite materials and performing strengthening processes for the improvement of its properties. With that, its possibility of market production is high. However, the availability of pertinent equipment and uneconomical production cost makes its adoption still implausible. To accelerate development, future studies should consider developing ways in creating durable yet cost-friendly PBBPs. In addition to that, biodegradability should also be considered. Shortening the biodegradation time and establishing a wide range of environmental conditions for degradation are some aspects to improve on. While PBBPs can reduce plastic consumption, it is not the silver bullet to ending plastic pollution.

5. ACKNOWLEDGMENTS

The authors would like to express their sincerest gratitude to Dr. Jose Isagani Janairo, Professor of the DLSU–Biology Department, for his valuable guidance and the knowledge that he has imparted to complete this project. They would also like to thank Ms. Liezl Rillera-Astudillo, STEM’s SHS Research Coordinator, for the encouragement and enlightenment that she has provided in this research endeavor. Above all, glory and thanks goes to God



Almighty for giving the authors the strength, knowledge, and ability to undertake this study. Without his providence, this accomplishment would not have been achieved.

6. REFERENCES

- Alizadeh-Sani, M., Khezerlou, A., & Ehsani, A. (2018). Fabrication and characterization of the bionanocomposite film based on whey protein biopolymer loaded with TiO₂ nanoparticles, cellulose nanofibers and rosemary essential oil. *Industrial Crops and Products*, 124, 300–315. <https://doi.org/10.1016/j.indcrop.2018.08.001>
- Baumeister, R. F. (2013). Writing a literature review. In M. J. Prinstein & M. D. Patterson (Eds.), *The portable mentor: Expert guide to a successful career in psychology* (pp. 119-132; 2nd ed.). New York: Springer Science+Business Media.
- Borela, V. T., & Apolar, D. A. (2020). Banana Peel Cellulose Nanofibers (CNFs) as Retrofitting Material to Soy-Protein in Manufacturing Biodegradable Food Packaging. *Journal of Scientific Research in Medical and Biological Sciences*, 1(1), 10–29. <https://doi.org/10.47631/jsrmb.v1i1.22>
- Chen, G., Dong, S., Zhao, S., Li, S., & Chen, Y. (2019). Improving functional properties of zein film via compositing with chitosan and cold plasma treatment. *Industrial Crops and Products*, 129, 318–326. <https://doi.org/10.1016/j.indcrop.2018.11.072>
- Connecticut Plastics. (2020). Biodegradable Plastics. <http://www.pepctplastics.com/resources/connecticut-plastics-learning-center/biodegradable-plastics/>
- Cui, H., Surendhiran, D., Li, C., & Lin, L. (2020). Biodegradable zein active film containing chitosan nanoparticle encapsulated with pomegranate peel extract for food packaging. *Food Packaging and Shelf Life*, 24, 100511. <https://doi.org/10.1016/j.foodpack.2020.100511>
- Diaz, O., Candia, D., & Cobos, Á. (2016). Effects of ultraviolet radiation on properties of films from whey protein concentrate treated before or after film formation. *Food Hydrocolloids*, 55, 189–199. <https://doi.org/10.1016/j.foodhyd.2015.11.019>
- Ferreira, L. F., de Oliveira, A. C. S., Begali, D. D. O., Neto, A. R. D. S., Martins, M. A., de Oliveira, J. E., Borges, S. V., Yoshida, M. I., Tonoli, G. H. D., & Dias, M. V. (2021). Characterization of cassava starch/soy protein isolate blends obtained by extrusion and thermocompression. *Industrial Crops and Products*, 160, 113092. <https://doi.org/10.1016/j.indcrop.2020.113092>
- Galus, S. (2018). Functional properties of soy protein isolate edible films as affected by rapeseed oil concentration. *Food Hydrocolloids*, 85, 233–241. <https://doi.org/10.1016/j.foodhyd.2018.07.026>
- Jiang, S.-juan, Zhang, X., Ma, Y., Tuo, Y., Qian, F., Fu, W., & Mu, G. (2016). Characterization of whey protein-carboxymethylated chitosan composite films with and without transglutaminase treatment. *Carbohydrate Polymers*, 153, 153–159. <https://doi.org/10.1016/j.carbpol.2016.07.094>
- Liang, S., & Wang, L. (2018). A Natural Antibacterial-Antioxidant Film from Soy Protein Isolate Incorporated with Cortex Phellodendron Extract. *Polymers*, 10(1), 71. <https://doi.org/10.3390/polym10010071>
- Perez, V., Felix, M., Romero, A., and Guerrero, A. (2016). Characterization of pea protein-based bioplastics processed by injection moulding. *Food and Bioproducts Processing*, 97(2016), 100-108. <https://doi.org/10.1016/j.fbp.2015.12.004>
- Qazanfarzadeh, Z., & Kadivar, M. (2016). Properties of whey protein isolate nanocomposite films reinforced with nanocellulose isolated from oat husk. *International Journal of Biological Macromolecules*, 91, 1134–1140. <https://doi.org/10.1016/j.ijbiomac.2016.06.077>
- Riaz, A., Lagnika, C., Luo, H., Dai, Z., Nie, M., Hashim, M. M., ... Li, D. (2020). Chitosan-based biodegradable active food packaging film containing Chinese chive (*Allium tuberosum*) root extract for food application. *International Journal of Biological Macromolecules*, 150, 595–604. <https://doi.org/10.1016/j.ijbiomac.2020.02.078>
- Samadani, F., Behzad, T., & Enayati, M. S. (2019). Facile strategy for improvement properties of whey protein isolate/walnut oil bio-packaging films: Using modified cellulose nanofibers. *International Journal of Biological Macromolecules*, 139, 858–866. <https://doi.org/10.1016/j.ijbiomac.2019.08.042>
- Sogut, E. (2020). Active whey protein isolate films including bergamot oil emulsion stabilized by nanocellulose. *Food Packaging and Shelf Life*, 23, 100430. <https://doi.org/10.1016/j.foodpack.2019.100430>
- Thompson, R. C., Moore, C. J., vom Saal, F. S., & Swan, S. H. (2009). Plastics, the environment and human health: current consensus and future trends. *Philosophical Transactions of the Royal Society B: Biological Sciences*, 364(1526), 2153–2166. <https://doi.org/10.1098/rstb.2009.0053>
- Tiseo, I. (2021). Global plastic production 1950-2019. <https://www.statista.com/statistics/282732/global-production-of-plastics-since-1950/>
- Tsai, M.-J., & Weng, Y.-M. (2019). Novel edible composite films fabricated with whey protein isolate and zein: Preparation and physicochemical property evaluation. *LWT*, 101, 567–574. <https://doi.org/10.1016/j.lwt.2018.11.068>
- Vahedikia, N., Garavand, F., Tajeddin, B., Cacciotti, I., Jafari, S. M., Omid, T., & Zahedi, Z. (2019). Biodegradable zein film composites reinforced with chitosan nanoparticles and cinnamon essential oil: Physical, mechanical, structural and antimicrobial attributes. *Colloids and Surfaces B: Biointerfaces*, 177, 25–32. <https://doi.org/10.1016/j.colsurfb.2019.01.045>
- Vanden Braber, N. L., Di Giorgio, L., Aminahuel, C. A., Díaz Vergara, L. I., Martín Costa, A. O., Montenegro, M. A., & Mauri, A. N. (2021). Antifungal whey protein films activated with low quantities of water soluble chitosan. *Food Hydrocolloids*, 110, 106156. <https://doi.org/10.1016/j.foodhyd.2020.106156>
- World Wide Fund for Nature. (2018). The scourge of single-use plastic in the Philippines. https://www.panda.org/knowledge_hub/where_we_work/coraltriangle/?329831/The-scourge-of-single-use-plastic-in-the-Philippines
- Xia, C., Zhang, S., Shi, S. Q., Cai, L., Garcia, A. C., Rizvi, H. R., & D'Souza, N. A. (2016). Property enhancement of soy protein isolate-based films by introducing POSS. *International Journal of Biological Macromolecules*, 82, 168–173. <https://doi.org/10.1016/j.ijbiomac.2015.11.024>
- Yu, Z., Sun, L., Wang, W., Zeng, W., Mustapha, A., & Lin, M. (2018). Soy protein-based films incorporated with cellulose nanocrystals and pine needle extract for active packaging. *Industrial Crops and Products*, 112, 412–419. <https://doi.org/10.1016/j.indcrop.2017.12.031>
- Zhang, S., Xia, C., Dong, Y., Yan, Y., Li, J., Shi, S. Q., & Cai, L. (2016). Soy protein isolate-based films reinforced by surface modified cellulose nanocrystal. *Industrial Crops and Products*, 80, 207–213. <https://doi.org/10.1016/j.indcrop.2015.11.070>



Oil Adsorption Capacity of Mahogany (*Swietenia macrophylla*) Fruit Shells in Varying Particle Sizes

Errol Emmanuel R. Ballares, Vivekjeet Singh Chambal, Harish K. Chawla, and
Charles Niegel E. Ocampo
De La Salle University Integrated School, Biñan City, Laguna

Abstract: The growing demands for petroleum products increase the risk of oil spills, and these accidents cause long-term devastation to biodiversity and communities. Researchers are now searching for adsorbents from biowastes due to current oil cleanup methods' costs and potential dangers. Hence, the lack of relevant studies and underutilization of mahogany (*Swietenia macrophylla*) fruit shells (MFS) have prompted an investigation into oil adsorption capacity and particle size effects. Sorption capacity was measured using untreated MFS in chosen particle sizes of B-8 ($0.6\text{mm} < x < 2\text{mm}$) and B-25 ($0.1\text{mm} < x < 0.6\text{mm}$) in pure oil and water systems and oil-water mixture. Contact time was optimized by comparing 1-hour and 24-hour exposure in the pure systems. Surface characterization showed heterogeneity with fiber aggregations and no porosity, limiting adsorption. One-Way Analysis of Variance determined contact time insignificance, greater water affinity of particles, and B-25 superiority, which achieved maximum adsorption of $1.886_{\text{go/gmfs}}$ in a pure oil system and $1.684_{\text{go/gmfs}}$ in an oil-water mixture due to the increased surface area in smaller particles. These results, combined with the limited usage of mahogany fruit shells, justify their use as a potential oil bioadsorbent.

Key Words: mahogany; particle size; oil spill; biosorbent; surface characterization

1. INTRODUCTION

The Exxon Valdez and Deepwater Horizon disasters in 1989 and 2010, respectively, are notable international oil spills; in the Philippines, the 2006 Guimaras oil spill headlines such occurrences. Although caused by varying factors in different places, the commonality between these disasters is a combination of destruction and long-term devastation. The adverse effects on marine life, seabird deaths, mangrove destruction, and community displacement recorded from these oil spills are proof of detrimental impacts to ecosystems, biodiversity, and humans (Barron et al., 2020; Beyer et al., 2016; Sacramento & Geges, 2019; Xia et al., 2017)

With 116,000 tons of oil released into water bodies in 2018 alone, these spills continue to pose significant risks to the environment (International Tanker Owners Pollution Federation Ltd., 2019). Researchers are developing cleanup techniques, with chemicals as the conventional means (Tewari & Sirvaiya, 2015). However, this approach is expensive and possibly dangerous to the environment if misused (El-Din et al., 2018; Shah et al., 2019). Thus, the need for inexpensive and sustainable alternative oil cleanup methods is highlighted in cases wherein the affected area lacks funds and resources. This challenge was apparent in the Guimaras oil spill, where the local government was forced to utilize an

improvised approach in cleaning the oil using human hair and chicken feathers from the locals (Patil et al., 2020; Romero, 2006).

The mentioned materials employ the biosorption method, which offers an eco-friendly treatment for reducing and recovering contaminants such as oil from aqueous mediums by using biodegradables or biomasses (Doshi et al., 2018). Since biosorption is geared towards providing a more straightforward and inexpensive alternative to chemical methods, the renewability and availability of industrial and agricultural waste products make these suitable biosorbents (Mohammed et al., 2014; Wolok et al., 2020).

Mahogany (*Swietenia macrophylla*) is a tree species naturalized to the Philippines; its fruits are known for a bursting mechanism that disperses seeds. Although its bark chunks are used in treating wounds and infections, and its logs utilized for furniture, the commercially established purposes and uses of mahogany products do not employ the fruit shell, making these widely underutilized waste products (Sartape et al., 2015). Currently, there have only been two biosorption studies conducted using mahogany fruit shells (MFS), with Sartape et al. (2015) reporting up to 99.05% removal of methylene blue dye at pH 9 and Magoling & Macalalad (2017) achieving 92.3% Chromium (VI) removal efficiency.

Finding other uses of MFS may reduce waste in areas with dense mahogany tree populations, and the potential for a successful bioadsorbent may benefit coastal communities at the most significant risk of oil spills. Hence, the researchers tested and statistically determined the effect of varying the MFS particle size and contact time on water sorption and oil adsorption capacity. To further understand the biosorbent, scanning electron microscope (SEM) analysis was done for surface characterization. It is worth noting that the study is limited to a home-based setup; therefore, synthetic motor oil was used as a substitute for crude oil, and no saltwater simulation was done. The inability to perform a more complex laboratory study does not invalidate the findings of this study; given the lack of research focusing on MFS, insights and baseline data on oil adsorption in this study will expand the scientific community's knowledge body.

2. METHODOLOGY

2.1. Biosorbent Preparation and Characterization

A kilogram of dried mahogany fruit shells was procured from a seller in Tambulig, Zamboanga del Sur, Philippines. The MFS preparation of Sartape et al. (2015) was adapted. The shells were brushed to remove foreign particles and sun-dried for 72 hours. After crushing, the MFS underwent batch screening using BSS 8 and BSS 25 test sieves and a 100µm mesh (Figure 1). Particle sizes of B-8 and B-25 were produced with ranges of $0.6\text{mm} < x < 2\text{mm}$ and $0.1\text{mm} < x < 0.6\text{mm}$ (Figure 2). These were stored in airtight containers with desiccants until usage.

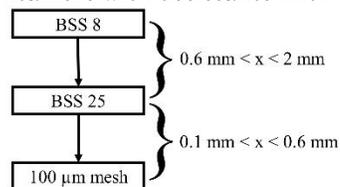

Figure 1. MFS Batch Screening Process



Figure 2. MFS Particle Sizes: (A) B-8 [$0.6\text{mm} < x < 2\text{mm}$] (B) B-25 [$0.1\text{mm} < x < 0.6\text{mm}$]

An MFS sample was sent via courier to the De La Salle University Central Instrumentation Facility (DLSU-CIF) for Scanning Electron Microscopy (SEM) using a JEOL JSM-IT500HR to perform surface characterization without Energy Dispersive X-ray Spectroscopy (EDS). Platinum

sputtering was ordered, and magnifications of 50X, 200X, 1000X, and 5000X were selected for the prepared biosorbent.

2.2. Biosorption Experiments

The methodology of Ben Jmaa & Kallel (2019) was adapted for the preparation of the pure systems and oil-water mixture. In identical glass containers of 900g capacity, the pure oil and pure water systems were filled with 30g of Raimol Flash 4T Motor Oil 20W-40 SG/CD and water, respectively. The original oil-water mixture ratio of 30g of motor oil to 970g of water was downscaled to 6g:194g to fit the same containers.

The pure systems were used to determine the maximum oil adsorption and water sorption capacity of the MFS and optimize the contact time for the oil-water mixture. One experiment run of the pure systems comprises pure oil and pure water setups for each particle size. These systems were agitated for 10 minutes using a magnetic stirrer set to 1000rpm before introducing 0.45g of MFS, the standard loading for both chosen particle sizes in all experiments. Subsequently, the systems with biosorbent were mixed for a further 15 minutes before letting these settle until the assigned contact time. A comparison between 1-hour and 24-hour contact time and biosorption capacity was drawn by performing five experiment runs of the pure systems in both particle sizes for each chosen duration.

The oil-water mixture aimed to simulate the performance of the MFS biosorbent in oil spill applications. An experiment run consists of three setups containing motor oil and water in a 6g:194g ratio: B-8 ($0.6\text{mm} < x < 2\text{mm}$), B-25 ($0.1\text{mm} < x < 0.6\text{mm}$), and C (No biosorbent). These mixtures were agitated for 10 minutes using a magnetic stirrer set to 1000rpm before MFS loading. The stirrer continued mixing for an additional 15 minutes, after which the setups were left to settle until the investigated contact time. Due to the presence of water in the mixture, the spent MFS biosorbents were dried in an oven at 90°C until weight became constant.

A 100µm mesh was used to recover spent MFS in both pure systems and oil-water mixtures, while a jewelry scale with accuracy up to 0.001g and a capacity of 50g was used in weighing samples. Ethical disposal of generated waste products was observed throughout experimentation.

2.3. Data Analysis Strategy

As adopted from de Fátima Gorgulho et al. (2018), Equation (1) was used to compute oil and water sorption capacity (q) by subtracting the weight of the MFS before sorption (W_i) from the weight after sorption (W_f); the difference was then divided by W_i (Figure 3). The mean sorption capacity values were

interpreted using One-Way Analysis of Variance (ANOVA) to statistically determine the significance of contact time to sorption, after which the same tool was used to investigate the relationship of particle size to sorption. In addition, the significance of the difference between MFS oil adsorption and water sorption was statistically tested by using ANOVA to compare the means of each particle size of the same contact time (Figure 4).

$$q = \frac{W_f - W_i}{W_i} \quad (1)$$

Where:

q = sorption capacity

W_i = initial mass of the MFS (before sorption)

W_f = final mass of the MFS (after sorption)

Figure 3. Sorption Capacity Formula

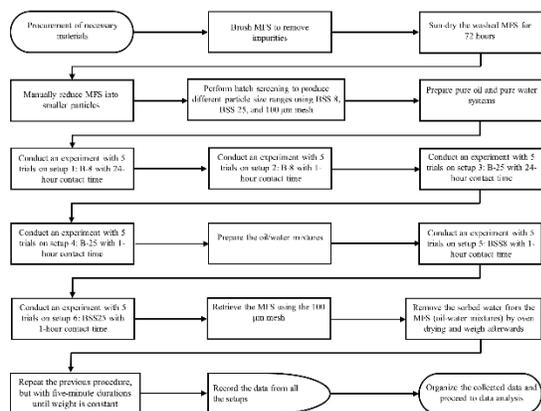

Figure 4. Flowchart of the Procedure

3. RESULTS AND DISCUSSION

3.1. Scanning Electron Microscope (SEM) Analysis

The analysis by the DLSU-CIF determined that at 50X magnification, the B-25 MFS sample consisted of long round-like fibers with varying sizes and inconsistent shape patterns (Figure 5). At 1000X, there were no signs of porosity; instead, a surface formed by aggregations of fiber layers and sheets was identified at 5000X (Figure 6). Fiber bundling in lignocellulosic biomasses such as MFS provides morphological structure (Lee et al., 2015; Magoling & Macalalad, 2017). Particle heterogeneity may increase adsorption as rough surface morphologies increase the surface area available (Meili et al., 2017; Shamim, 2018; Zanini et al., 2017).

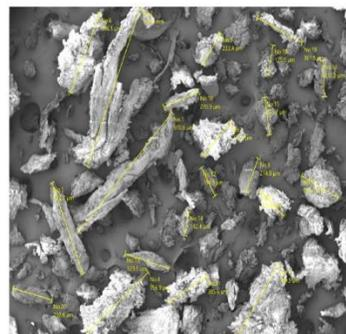

Figure 5. Measured MFS Particles

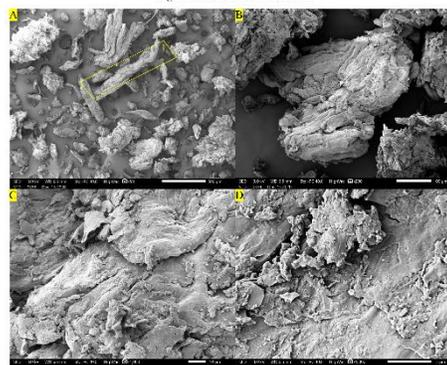

Figure 6. MFS SEM Images: (A) 50X (B) 200X (C) 1000X (D) 5000X

The SEM analysis findings are also aligned with the data from Sartape et al. (2015), who have reported beforehand that the MFS exhibit a rough surface morphology due to the incorporation of multiple particles that smoothed after adsorption.

3.2. Average Sorption Capacities in Pure Systems

Table 1. B-8 Mean Sorption Capacities

	Mean Sorption	
	1-hour	24-hour
Pure water (g water / g MFS)	2.173	1.995
Pure oil (g oil / g MFS)	1.558	1.649

Average water sorption for B-8 after five trials was 2.173_{gw/gmfs} and 1.995_{gw/gmfs} in 1-hour and 24-hour setups, respectively (Table 1). The results show that the shorter contact time produced better results when compared to the 24-hour exposure; therefore, informally validating the hypothesis that there are no significant drawbacks to choosing a 1-hour contact time. Mean oil adsorption shows 1.558_{go/gmfs} and 1.649_{go/gmfs} uptake in 1-hour and 24-hour setups, respectively (Table 1). Unlike the pure water system, the longer contact time is associated with greater adsorption capacity, prompting statistical analysis for the significance of the difference. The mean values for sorption in both assigned contact times suggest particles' greater affinity for water, as evidenced by the higher water sorption values.



Table 2. B-25 Mean Sorption Capacities

	Mean Sorption	
	1-hour	24-hour
Pure water (g water / g MFS)	2.827	2.822
Pure oil (g oil / g MFS)	1.769	1.886

Average water sorption for B-25 after five trials was 2.827_{gw/gmfs} and 2.822_{gw/gmfs} in 1-hour and 24-hour setups, respectively (Table 2). The results are consistent with the findings from the B-8 tests, showing that the shorter contact time produced better results. This trend suggests that there may be no significant adverse impacts if a 1-hour contact time is chosen. It is worth noting that the difference between the two is slim; hence, further statistical analysis is needed. Mean oil adsorption shows 1.769_{go/gmfs} and 1.886_{go/gmfs} uptake in 1-hour and 24-hour setups, respectively (Table 2). These values are aligned with the B-8 results, which presented greater oil adsorption capacity in 24 hours, prompting statistical analysis for the significance of the difference. Greater water sorption is also evident in the B-25 particle size.

3.3. Effects of Contact Time on Sorption Capacity

Table 3. Comparison of Sorption in 1-hour and 24-hour Contact Times

Dataset (1 hour vs. 24 hours)	P-value (α = 0.05)	Remarks
B-8 (Pure Water)	0.546	Insignificant
B-8 (Pure Oil)	0.261	Insignificant
B-25 (Pure Water)	0.961	Insignificant
B-25 (Pure Oil)	0.288	Insignificant

The B-8 pure water and oil systems had a p-value of 0.546 and 0.261, respectively, when the two contact time groups were subjected to One-Way ANOVA. The B-25 pure water and oil systems garnered p-values of 0.961 and 0.288 when using the same statistical method (Table 3). The analysis proved that in all pure systems, regardless of particle size, the sorption capacities of 1-hour and 24-hour contact times were not significantly different (p > 0.05). This result determined that no significant drawbacks are attributed to a shorter exposure time. Therefore, the choice to employ a 1-hour contact time in the oil-water mixture experiments is justified.

3.4. Statistical Difference of Water Sorption and Oil Adsorption

Table 4. Comparison of Water and Oil Sorption Capacities

Dataset (Water Sorption vs. Oil Adsorption)	P-value (α = 0.05)	Remarks
B-8 (1 hour)	0.035	Significant
B-8 (24 hours)	0.065	Insignificant
B-25 (1 hour)	6.6 x 10 ⁻⁵	Significant
B-25 (24 hours)	6.6 x 10 ⁻⁵	Significant

When comparing water sorption and oil adsorption in the pure systems, the One-Way ANOVA

resulted in p-values of 0.035, 0.065, 6.6 x 10⁻⁵, and 6.6 x 10⁻⁵ for B-8 1-hour, B-8 24-hour, B-25 1-hour, and B-25 24-hour setups, respectively (Table 4). These values indicate that there is no significant difference in water and oil sorption in B-8 with 24 hours of contact time (p > 0.05). However, contrary to this finding, B-8 and B-25 with 1-hour contact time and B-25 with 24 hours of contact have a significantly greater affinity for water intake (p < 0.05). The data and statistical analysis suggest that MFS, similar to most untreated lignocellulosic biomasses, does not exhibit hydrophobicity (Sbiai et al., 2011).

3.5. Oil Adsorption in Oil-water Mixture

Table 5. Oil Adsorption Capacity in Oil-water Mixture

	Mean Sorption
B-8 (g oil / g MFS)	1.478
B-25 (g oil / g MFS)	1.684

The mean adsorption capacities in the oil-water mixture after five trials were 1.478_{go/gmfs} and 1.684_{go/gmfs} for B-8 and B-25, respectively (Table 5). The data showed greater oil adsorption for B-25. Statistical analysis is needed to characterize the difference between the two particle sizes.

3.6. Effect of Particle Size on Sorption

Table 6. Particle Size Comparison in Pure Systems

Dataset (B-8 vs. B-25)	P-value (α = 0.05)	Remarks
Pure Water (1 hour)	0.024	Significant
Pure Water (24 hours)	0.002	Significant
Pure Oil (1 hour)	0.043	Significant
Pure Oil (24 hours)	0.032	Significant

When comparing the two chosen particle sizes in pure water systems, p-values were determined to be 0.024 and 0.002 for 1-hour and 24-hour contact times, respectively. Regarding pure oil systems, the p-values for 1 hour and 24 hours were 0.043 and 0.032 (Table 6). The statistical analysis determined that the B-25 particle size has significantly higher oil adsorption and water sorption capacity than B-8 across all contact times (p < 0.05). This result implies that the smaller particle size performs better in systems containing pure substances; however, the performance of the MFS biosorbent in a mixture cannot be generalized from this finding.

Table 7. Particle Size Comparison in Oil-Water Mixture

Dataset (B-8 vs. B-25)	P-value (α = 0.05)	Remarks
Oil-Water Mixture	0.003	Significant

One-Way ANOVA results showed a p-value of 0.003 when the B-8 and B-25 particle sizes were compared (Table 7). The B-25 MFS bioadsorbent was determined to have a significantly greater oil adsorption capacity in oil-water mixtures based on



this value. This finding was consistent with the results of particle size comparison in the pure water and oil systems.

The consistency of B-25 in outperforming B-8 in terms of sorption capacity can be observed across all the experimental setups (Figure 7). The sorption superiority of the finer particles may be explained by the increased surface area associated with smaller sorbent sizes, which gives rise to a more significant number of binding sites and contact surfaces on the MFS, ultimately enhancing the sorption capacity in the process (Behnood et al., 2013; El Gheriany et al., 2020; Ibrahim et al., 2009; Kelly-Vargas et al., 2012).

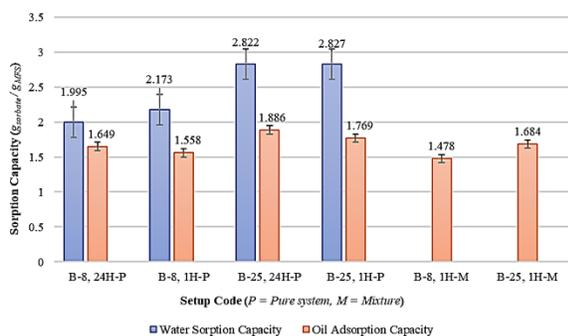

Figure 7. Mean Sorption Values in the Biosorption Experiments

4. CONCLUSIONS

Statistical analysis determined an insignificant difference in the 1-hour and 24-hour contact times. It was noted that the B-25 particle size (0.1mm<x<0.6mm) was more effective than B-8 at sorption in both pure systems and oil-water mixtures due to the increased surface area in smaller particles. However, One-Way ANOVA presented the biosorbents' significantly higher affinity for water. MFS water sorption is attributed to it being untreated lignocellulosic biomass; whereas, the low oil adsorption capacity is due to the lack of porosity. The investigation on the oil adsorption of MFS and particle size effects suggests that the bioadsorbent can be used as a potential oil cleanup method. Considering that mahogany (*Swietenia macrophylla*) fruit shells are underutilized wastes, an added purpose expands the body of knowledge and benefits places with dense mahogany tree populations.

Home-based experimentation limited the capacity to use crude oil and saltwater; hence synthetic motor oil and tap water were used as substitutes. An investigation into the performance of MFS in adsorbing different oil types in saltwater is recommended. Noting the hydrophilic nature of lignocellulosic biomasses, further studies may focus on the physicochemical modification of MFS to optimize adsorption. Lastly, the determined water affinity opens up pathways for future research

concerned with MFS use in water or moisture sorption.

5. ACKNOWLEDGMENTS

We express our gratitude to our research adviser Engr. Shelah Alfaro and research mentor Ms. Leah Madrazo for their insights and guidance. We acknowledge the help of Dr. Kerry Cabral, who accepted our consultations, and Ms. Emmielyn Bardiano, who validated our statistics. Likewise, we thank the De La Salle University Integrated School for research funding and the De La Salle University Central Instrumentation Facility (DLSU-CIF) for SEM analysis and interpretation services. Lastly, we thank our families and peers for their unending support.

6. REFERENCES

Barron, M. G., Vivian, D. N., Heintz, R. A., & Yim, U. H. (2020). Long-term ecological impacts from oil spills: comparison of exxon valdez, hebei spirit, and deepwater horizon. *Environmental science & technology*, 54(11), 6456-6467.

Behnood, R., Anvaripour, B., Jaafarzade Haghghi Fard, N., & Farasati, M. (2013). Application of natural sorbents in crude oil adsorption. *Iranian Journal of Oil and Gas Science and Technology*, 2(4), 1-11.

Ben Jmaa, S., & Kallel, A. (2019). Assessment of performance of *Posidona oceanica* (L.) as biosorbent for crude oil-spill cleanup in seawater. *BioMed research international*, 2019.

Beyer, J., Trannum, H. C., Bakke, T., Hodson, P. V., & Collier, T. K. (2016). Environmental effects of the Deepwater Horizon oil spill: a review. *Marine pollution bulletin*, 110(1), 28-51.

de Fátima Gorgulho, H., da Silva Guilharduci, V. V., & Martelli, P. B. (2018). Sugarcane Bagasse as Potentially Low-Cost Biosorbent. *Sugarcane: Technology and Research*, 265.

Doshi, B., Sillanpää, M., & Kalliola, S. (2018). A review of bio-based materials for oil spill treatment. *Water research*, 135, 262-277.

El-Din, G. A., Amer, A. A., Malsh, G., & Hussein, M. (2018). Study on the use of banana peels for oil spill removal. *Alexandria engineering journal*, 57(3), 2061-2068.

El Gheriany, I. A., El Saqa, F. A., Amer, A. A. E. R., & Hussein, M. (2020). Oil spill sorption capacity of



- raw and thermally modified orange peel waste. *Alexandria Engineering Journal*, 59(2), 925-932.
- Ibrahim, S., Ang, H. M., & Wang, S. (2009). Removal of emulsified food and mineral oils from wastewater using surfactant modified barley straw. *Bioresource technology*, 100(23), 5744-5749.
- International Tanker Owners Pollution Federation Ltd. (2019). 2018 Tanker Oil Spill Statistics: Number of spills remains low. <https://www.itopf.org/news-events/news/article/2018-tanker-oil-spill-statistics-number-of-spills>
- Kelly-Vargas, K., Cerro-Lopez, M., Reyna-Tellez, S., Bandala, E. R., & Sanchez-Salas, J. L. (2012). Biosorption of heavy metals in polluted water, using different waste fruit cortex. *Physics and Chemistry of the Earth, Parts A/B/C*, 37, 26-29.
- Lee, C. M., Kubicki, J. D., Fan, B., Zhong, L., Jarvis, M. C., & Kim, S. H. (2015). Hydrogen-bonding network and OH stretch vibration of cellulose: comparison of computational modeling with polarized IR and SFG spectra. *The Journal of Physical Chemistry B*, 119(49), 15138-15149.
- Magaling, B. J. A., & Macalalad, A. A. (2017). Optimization and response surface modelling of activated carbon production from Mahogany fruit husk for removal of chromium (VI) from aqueous solution. *BioResources*, 12(2), 3001-3016.
- Meili, L., da Silva, T. S., Henrique, D. C., Soletti, J. I., de Carvalho, S. H. V., Fonseca, E. J. D. S., ... & Dotto, G. L. (2017). Ouricuri (*Syagrus coronata*) fiber: a novel biosorbent to remove methylene blue from aqueous solutions. *Water Science and Technology*, 75(1), 106-114.
- Mohammed, M. A., Shitu, A., & Ibrahim, A. (2014). Removal of methylene blue using low cost adsorbent: a review. *Research Journal of Chemical Sciences*, 4(1), 91- 102.
- Patil, S. B., Shreya, K., & Kruti, S. (2020). Extraction of Amino acids from Human Hair" Waste" and Used as a Natural Fertilizer. *Journal of Pharmaceutical Sciences and Research*, 12(2), 271-278.
- Romero, P. (2006, August 28). GMA to unveil Guimaras rehab plan. *The Philippine Star*. <https://www.philstar.com/headlines/2006/08/28/355012/gma-unveil-guimaras-rehab-plan>
- Sacramento, N. J. J., & Geges, D. (2019). Community Livelihood Recovery: Experiences from 2006 Guimaras Oil Spill in the Philippines. *Journal of Human Ecology*, 8(1).
- Sartape, A. S., Patil, S. A., Patil, S. K., Salunkhe, S. T., & Kolekar, S. S. (2015). Mahogany fruit shell: a new low-cost adsorbent for removal of methylene blue dye from aqueous solutions. *Desalination and Water Treatment*, 53(1), 99-108.
- Sbiai, A., Kaddami, H., Sautereau, H., Maazouz, A., & Fleury, E. (2011). TEMPO-mediated oxidation of lignocellulosic fibers from date palm leaves. *Carbohydrate Polymers*, 86(4), 1445-1450.
- Shah, M. U. H., Moniruzzaman, M., Sivapragasam, M., Talukder, M. M. R., Yusup, S. B., & Goto, M. (2019). A binary mixture of a biosurfactant and an ionic liquid surfactant as a green dispersant for oil spill remediation. *Journal of Molecular Liquids*, 280, 111-119.
- Shamim, S. (2018). Biosorption of heavy metals. *Biosorption*, 2, 21-49.
- Tewari, S., & Sirvaiya, A. (2015). Oil spill remediation and its regulation. *International Journal of Engineering Research and General Science*, 1(6), 1-7.
- Wolok, E., Barafi, J., Joshi, N., Girimonte, R., & Chakraborty, S. (2020). Study of bio-materials for removal of the oil spill. *Arabian Journal of Geosciences*, 13(23), 1-11.
- Xia, W., Zhou, C., & Peng, Y. (2017). Enhancing flotation cleaning of intruded coal dry-ground with heavy oil. *Journal of Cleaner Production*, 161, 591-597.
- Yang, J., Ching, Y. C., & Chuah, C. H. (2019). Applications of lignocellulosic fibers and lignin in bioplastics: A review. *Polymers*, 11(5), 751.
- Zanini, M., Marschelke, C., Anachkov, S. E., Marini, E., Synytska, A., & Isa, L. (2017). Universal emulsion stabilization from the arrested adsorption of rough particles at liquid-liquid interfaces. *Nature communications*, 8(1), 1-9.



Comparative Analysis of Colorfastness of Extracted Pigment from Kangkong (*Ipomoea aquatica*) with Varied Alcohol Solutions

Edryd Psalm I. Logrono, Raine Malachi H. Odiver, and Callista Unique V. Panganiban
De La Salle University Integrated School, Biñan City, Laguna

Abstract: Inorganic pigments are the most preferred pigments to be produced due to their greater resistance to fade, efficiency in the application, and how it is overall easier and faster to produce. However, natural water is polluted, and close vegetation is damaged because of the affected water channels that have been damaged due to improper disposal by the manufacturing industry. This paper reviews a comparative analysis of the colorfastness of extracted pigment from kangkong with varied alcohol solutions. A total of 7 varying ethyl alcohol solutions with concentrations ranging from 10% to 70% were obtained using the dilution equation. Kangkong leaves were then utilized for the extraction of chlorophyll due to its high leaf yield rate. The Brightness levels and Saturation levels had an inverse and direct correlation to the alcohol concentration, respectively. This suggests that a greater alcohol concentration is more effective and efficient in the extraction of chlorophyll because the samples had a better expression of colors. After observing the color value before and after administering the colorfastness test, the alcohol concentration in the extraction of chlorophyll has an inverse relationship with the colorfastness of the pigment on textile material.

Key Words: kangkong; ethyl alcohol; colorfastness; chlorophyll; pigment

1. INTRODUCTION

Pigment has been used since 2600 BC and has grown in relevance to society over time (Whittle, S., 2016). However, it is relatively unappreciated by the masses. It has both a functional and aesthetic significance in its application to textile materials. In the coming years, its market size is expected to grow in value, with it having reached 33.2 billion US dollars back in 2019 (Grand View Research, 2020). With the rapid increase in value for pigment, the methods employed to achieve this feat are questioned.

There are two types of pigments that are used for application on textile materials: organic and inorganic pigments. The latter being the most preferred to be produced. This is due to the inorganic pigment's greater resistance to fade, efficiency in the application, and how it is overall easier and faster to produce. However, the production method that is used for inorganic pigments is destructive to the environment. Inorganic pigments are produced by using inorganic metallic compounds, that if used in high amounts, will cause a negative effect on the environment it is exposed to.

Due to a majority of the manufacturing industry using inorganic pigments as colorants for their products, natural water is polluted and close vegetation is damaged because of the affected water channels (Impact of dyes, 2016). The reason behind this damage is due to inorganic pigments being composed of chemicals, that if disposed of improperly,

may cause a negative impact on the aforementioned water channels (Koel Colours Private Limited, 2018). Despite this, the cost-effectiveness of inorganic pigments has allowed the pigments to be continually produced, thus increasing water pollution in the environment. As such, it is necessary to provide grounds for manufacturers to transition to utilizing organic pigments, as well as using an alternative environment-friendly production method.

For this study, the researchers have opted to see if the variation of alcohol concentrations in the use of ethyl alcohol in the extraction of chlorophyll from Kangkong leaves will result in the change of color fastness when applied to cotton textile material.

2. METHODOLOGY

The methodology of this study has a total of 5 phases wherein phase 1 is the preparation of alcohol concentrations by dilution, phase 2 is the extraction of chlorophyll using the diluted alcohol concentrations, phase 3 is where the pigment is applied to the textile, phase 4 is the colorfastness test, and finally, in phase 5, the color value is then digitally identified.

2.1 Materials and Equipment

The following materials were used by the researchers for this study: cotton textile materials, kangkong leaves, and 70% ethyl alcohol. As for the equipment, a medium-sized pot was used for the extraction process of the chlorophyll.

2.2 Preparation of Alcohol Concentrations

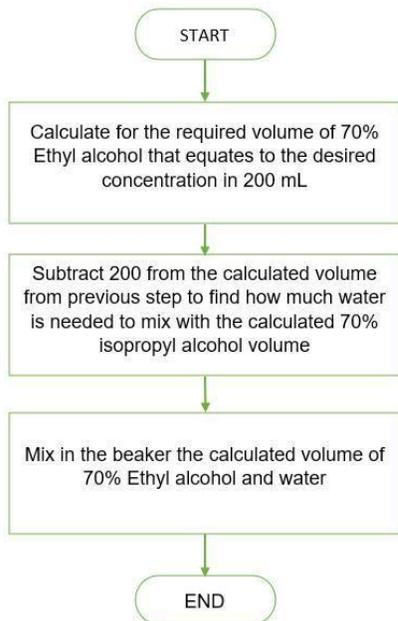

Fig. 1. Preparation of alcohol concentration by dilution

Due to ethyl alcohol being solely commercially sold in 70% alcohol concentrations, a method for diluting the alcohol from 70% is necessary to obtain varying concentrations for the study. Using the dilution equation, which is $(C_1)(V_1) = (C_2)(V_2)$, we calculate the volume of the starting solution, which is represented by V_1 . Initial concentration is represented by C_1 , while C_2 represents the desired concentration and V_2 for the total final volume. After dilution, a total of 7 solutions of varying ethyl alcohol concentrations should be obtained.

2.3 Extraction of Chlorophyll



Fig. 2. Extraction of chlorophyll with varying alcohol concentrations

The process of extracting the chlorophyll from the kangkong leaves is straightforward. It simply involves submerging the leaf into boiling water

to weaken it and allow the chlorophyll to more easily transfer into the solvent, ethyl alcohol. For 6 min, the leaf sits within the boiling water, which is the time found after performing preliminary tests to determine the steps that needed to be adjusted to properly extract the chlorophyll. The weakened leaf is allowed to rest, submerged in the bowl of 200 milliliters (mL) ethyl alcohol for 1 h. Once extracted, the chlorophyll-alcohol solution is immediately used in the next phase.

2.4 Application of Chlorophyll to Textile

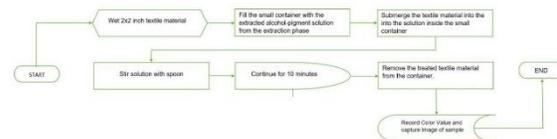

Fig. 3. Application of chlorophyll onto textile material

The extracted chlorophyll is used to dye a 2 in x 2 in textile material made of cotton. The bucket method or sink method was used to apply the chlorophyll. The method is simply submerging the textile into the chlorophyll-alcohol solution for 10 min while it is stirred to ensure an equal distribution of color across the sample. The samples were then dried while concealed from sun exposure to prevent them from being affected by lightfastness, which is different from colorfastness. Once dried, the images of the samples were captured with the homemade photo studio. More details on the studio will be provided in a later section.

2.5 Colorfastness Test

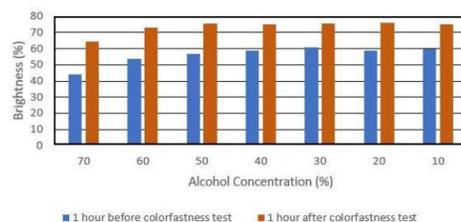

Fig. 5. Comparison of average brightness levels of the samples before and after the colorfastness test.

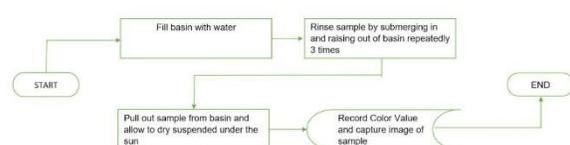

Fig. 4. Colorfastness test method

Once the samples have been collected, it is then subjected to the colorfastness test. The test involves replicating the stress typical clothing undergoes while laundering to observe if the color will fade after experiencing the stress. The test is based on the colorfastness test procedures published by the Southeast University (Shishir, M. M. H., 2014). After preliminary testing, it was necessary to decrease the stress since the color fade is too extreme to make a comparative analysis between the samples. The samples were submerged into room temperature water repeatedly for 3 times and then dried in the same drying conditions mentioned in the previous phase.

2.6 Digital Identification of Color Value

A digital application was used to digitally identify them using the images captured using the home studio to identify the color value of the samples. The application used is adobe photoshop was able to provide a detailed analysis of the coloration of the sample using the captured images such as the hue, saturation, and brightness. These are necessary components to assess the change in coloration of the sample before and after the colorfastness test since the loss of color due to color fade is attributed to the loss of saturation in a color (What is Color Fading and Can It Be Prevented, 2017).

3. RESULTS AND DISCUSSION

A total of 7 varying ethyl alcohol solutions with concentrations ranging from 10% to 70% were obtained. It was observed that a noticeable change in color had occurred in the solutions. Due to how in each solution, the percentage of the ethyl alcohol used was decreased, resulting in the dilution of color in the decreasing concentrations. As for the cotton textile materials, each piece had been submerged in a corresponding ethyl alcohol solution for over 12 hours to best see the coloration of the chlorophyll. As for the drying process, it was opted that the cotton textile was to be dried under a period of 10 minutes with no exposure to sunlight

The brightness levels, which correspond to the color value of a sample, were found for each sample before and after the colorfastness test seen. The average levels across the three trials were found and graphed in figure 5. The Saturation levels were also taken into account because this also represents an important component in the expression of color. Like the brightness levels, the average saturation levels across all three trails for each alcohol concentration was found. This can be viewed in figure 6. The Brightness levels had an inverse correlation

with the alcohol concentration, while the Saturation levels had a direct correlation with the alcohol concentration based on the graphs of the average levels of brightness and saturation. These relationships imply that a greater alcohol concentration is more effective and efficient in extraction chlorophyll because the samples had a better expression of colors. This is consistent with the fact that alcohol is capable of weakening the cell walls of plant cells to allow for the contents of the cell to be released (Center, B. S, 2015). It is because of this function of alcohol that chlorophyll can easily be extracted with solutions of greater alcohol concentrations.

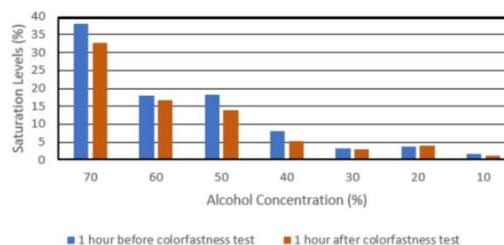

Fig. 6. Comparison of average saturation levels of the samples before and after the colorfastness test.

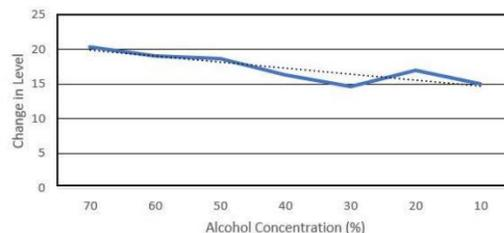

Fig. 7. Difference of Average Brightness levels before and after the colorfastness test.

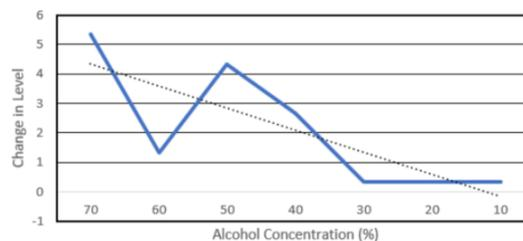

Fig. 8. Difference of Average Saturation levels before and after the colorfastness test.

There is a clear effect from the colorfastness test; however, what is important is how drastic the change is in each level after administering the test after comparing the levels of the samples before and after the colorfastness test. It can be observed from figures 7 and 8 that as the concentration of the alcohol decreased, there is a noticeable loss of change in levels. The difference implies that there is an inverse relationship between alcohol concentration and



colorfastness because there is a decrease in the difference between the average brightness and saturation levels before and after the test, albeit minimal.

4. CONCLUSIONS

After observing the color value before and after administering the colorfastness test, alcohol concentration in the extraction of chlorophyll has an inverse relationship with the colorfastness of the pigment on textile material. Additionally, it also has an inverse relationship with brightness levels and a direct relationship with saturation levels. If the priority is to provide a higher quality color application on textile material, then the use of a high alcohol concentration when extracting chlorophyll is preferred; however, if colorfastness is prioritized, finding an alcohol level that balances the color expression while maintaining a minimal loss of color is necessary.

5. ACKNOWLEDGMENTS

The researchers would like to thank Dr. Kerry P. Cabral for his continuous efforts in supporting and advising the researchers throughout the research paper.

6. REFERENCES

- Center, B. S. (2015, June 30). Alcohols. BODE SCIENCE CENTER. <https://www.bode-science-center.com/center/glossary/alcohols.html>
- Grand View Research (2020). Dyes and Pigments Market Size, Share & Trends Analysis Report by Product (Dyes (Reactive, Vat, Acid, Direct, Disperse), Pigment (Organic, Inorganic)), By Application, By Region, And Segment Forecasts, 2020 - 2027. Market Analysis Report, N/A(N/A), 1-130. <https://www.grandviewresearch.com/industry-analysis/dyes-and-pigments-market>
- Impact of dyes. (2016, June 29). Trusted Clothes. <https://www.trustedclothes.com/blog/2016/06/23/impact-of-dyes/>
- Koel Colours Private Limited. (2018). Difference between Organic Pigments and Inorganic pigments. Retrieved from <https://www.koelcolours.com/blog/pigments/difference-organic-pigments-inorganic-pigments/#:~:text=Organic%20pigments%20are%20made%20up,chemical%20composition%20to%20create%20colours.>

Shishir, M. M. H. (2014, March 24). Color fastness of dyed goods. Slideshare. <https://www.slideshare.net/sheshir/color-fastness-to-dyed-goods-gp-3>

What is Color Fading and Can It Be Prevented? (2017, December 26). Embassy Cleaners - Dry Cleaner Specializing in Carpet Cleaning and Restoration in Westchester, NY. <https://embassycleaners.com/color-fading/>

Whittle, S. (2016). The History of Fabric Dye. Retrieved from <https://www.acecleanuk.co.uk/blog/the-history-of-fabricdye/#:~:text=The%20first%recorded%20mention%20of,of%20clothing%20is%20dye%20synthetically.>



Advantages and Disadvantages of Traditional Abaca, Genetically Modified Abaca, and Cross Hybrid Abaca

Aizell G. Cabotage, Janelle Claire S. Lam, Gabriel Paul W. Lozada
and Mikaela Mae S. Pascasio
De La Salle University Integrated School, Manila

Abstract: Abaca (*Musa Textilis Née*), also known as Manila hemp, is a plant native to the Philippines, which expanded through different parts of Asia. It is a biodegradable and sustainable source of fiber known for its high quality. Due to viruses, poor government support, and lack of fundings, the abaca fiber industry is encountering obstacles in keeping up with the global demands. Over time, researchers developed new abaca types such as crossbred abaca and genetically modified abaca to solve these problems, but these have their own deficiencies as well. The purpose of the study was to identify, assess, and elaborate on the advantages and disadvantages of each of the abaca types. This was accomplished through the evaluation of literature and the collection of data in interviews. The study was a systematic review focusing on meta-synthesis, with information derived from previously published research or related literature and information from experts in the field. It was determined that traditional abaca is vastly preferred over genetically modified abaca and cross hybrid abaca, due to a number of reasons, including lack of research and economic viability. Traditional abaca was found to be more sustainable overall. It was recommended that traditional abaca should be promoted more to spread awareness, and that farmers should be educated regarding the proper process of caring for abaca plants. Stigma regarding cross hybrid and genetically modified abaca should be addressed as well.

Key Words: traditional abaca; cross hybrid abaca; genetically modified abaca; Philippine abaca industry; abaca virus

1. INTRODUCTION

1.1 Background of the study

Abaca, also known as *Musa textilis Née*, is a plant that originated in the Philippines. It is known as Manila hemp internationally. The Philippines was first to cultivate (Lalusin, 2010) and has remained the world's top abaca supplier for several years. It is among the country's top exports, boosting the Philippines' economy, and has an average of 4.7 billion pesos in export value (PhilFIDA, n.d.). Traditional varieties are still used due to the lack of new and improved varieties of abaca (Lalusin, 2010). These traditional abaca varieties are more likely to contract diseases such as the abaca bunchy top virus (ABTV) or the abaca bract mosaic virus. These viruses kill or give low-quality abaca yields, potentially affecting the industry as it reduces the income of many 21st century farmers. Furthermore, the Philippines is currently facing competition in the abaca industry with Indonesia and Costa Rica.

Top Abaca Producing Countries

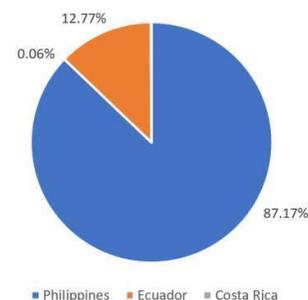

Figure 1. Top abaca producing countries.

Waller et al. (2019) stated that farmers lack knowledge in utilizing modern farming practices affecting farming productivity and efficiency. Moreover, the PhilFIDA roadmap of 2018-2020 discussed issues about lack of funding for the abaca industry requiring 5.633P billion and that more abaca seedling nurseries are lacking per region to hike outputs in production. Furthermore, the industry has



been encountering losses due to the impacts led by the abaca viruses and poor management of the government. The researchers were led to conduct the study because of the lack of consolidating research regarding which among cross hybrid abaca, genetically modified abaca, and traditional abaca is considered the best. The advantages and disadvantages of each abaca type will be determined, assessed, and compared. Furthermore, the study would help 21st-century farmers apply new farming methods and help the industry gain new and efficient farming methods and techniques.

1.2 Research Questions

Due to the lack of consolidating research, there is no concrete and validated document that can be distributed regarding which type of abaca is best to cultivate, given the properties and characteristics of the different abaca types. With that, the researchers aim to answer the following questions:

1. Which among traditional abaca, genetically modified abaca, and cross hybrid abaca is best suited for the Philippines' abaca industry in terms of economic viability, growth, and production?
2. What are their properties, uses, and applications?
3. What are the advantages and disadvantages of each?
4. How will their advantages or benefits, disadvantages or issues, and properties affect the Philippine abaca industry?

1.3 Objectives

The researchers assessed the advantages and disadvantages of traditional abaca, genetically modified abaca, and cross hybrid abaca. The specific objectives are as follows:

- a) To identify the properties and uses of traditional abaca, genetically modified abaca, and cross hybrid abaca
- b) To determine and assess their benefits and issues and their possible impacts and influences in the abaca industry
- c) To compare and evaluate the differences between each type of abaca

1.4 Scope and Limitations

This study reviewed, compared, and assessed the advantages and disadvantages between traditional abaca, genetically modified abaca, and cross hybrid abaca, which was done through a systematic review focusing on meta-synthesis. The data was derived from interviews of experts or people involved with the Philippine abaca industry, as well

as previous studies to find which abaca type would be more beneficial economically and agriculturally. Interviews were conducted for clarification and support for the gathered data. The different properties and uses of the abaca types were discussed and distinguished from each other. Each abaca type was examined, identifying its benefits and disadvantages.

1.5 Significance of the Study

The comparisons between traditional, crossbred, and genetically modified variants of abaca can help 21st-century farmers gain information in applying modern methods and techniques in farming. It can guide in identifying the type of abaca, its properties, its productivity, efficiency, and effectiveness in farming. This study can also aid experts and organizations in the abaca industry in identifying needed information for strategies to improve the abaca economy, aid industrial growth, compete internationally, and utilize advanced agricultural methods. The paper may also help future researchers and organizations in conducting similar studies about the abaca industry.

2. METHODOLOGY

The researchers performed a systematic review focusing on meta-synthesis regarding the characteristics and properties of each type of abaca from related studies. A meta-synthesis is used to combine qualitative data by combining information from related literature to find common themes and concepts (Siddaway et al., 2019). A systematic review was utilized for this paper because it summarizes the large quantities of research that have been published about the different types of abaca.

The researchers first identified the research questions, then searched for related literature, composed of articles selected through inclusion criteria. The content from the articles was analyzed and various themes were noted. Following that, respondents for the study were identified and contacted, and online interviews or surveys were conducted to further expound and validate the previously collected data. The data from the interviews was cross-checked with the previous data to find similar ideas and themes. The data were synthesized and evaluated to find the answers to the questions presented. The results were then interpreted and the conclusion for the topic was formed.

The data was presented through a narrative on which abaca cultivar is the most preferable to produce and utilize. The reasons and explanations as to why would be presented as well to elaborate the previously found data and research.



Inclusion Criteria (Respondents)	Inclusion Criteria (Related Literature)
<ul style="list-style-type: none"> • Experts that are in the abaca field or have connections to the abaca industry 	<ul style="list-style-type: none"> • Local and international studies published after 2010 that is related to abaca
<ul style="list-style-type: none"> • Experts that have conducted abaca-related research 	<ul style="list-style-type: none"> • Qualitative, quantitative, and mixed methodology
<ul style="list-style-type: none"> • Relevant government officials 	<ul style="list-style-type: none"> • Academic journals, conference papers, and reports related to abaca
	<ul style="list-style-type: none"> • News articles regarding discoveries in the abaca industry
	<ul style="list-style-type: none"> • Non-academic articles from reputable sources
	<ul style="list-style-type: none"> • Older studies documenting the history of abaca in the Philippines
	<ul style="list-style-type: none"> • Situations of 21st-century farmers in the Philippines

3. RESULTS AND DISCUSSION

3.1 Characteristics of Abaca

Abaca is among the strongest natural fibers. It can be used as a raw material in textile manufacturing. It has high fiber yield and quality, high tensile strength, and resistance to virus diseases. Abaca is considered to be sustainable, as its waste can be reused as fertilizer. It is also the type of abaca preferred by buyers and farmers due to familiarity and that other abaca types may have unwanted side effects.

Cross hybrid abaca possesses high yield, good fiber quality, and disease resistance. The Bandala hybrid, specifically, is resistant to the bunchy top virus. Another abaca hybrid, a hybrid of Pacol and traditional abaca, is also resistant to ABTV and can be used as a raw material. However, its fiber quality is lacking (Lalusin et al., 2015). It is stated that cross hybrid abaca has similar qualities to traditional abaca, such as folding endurance, burst strength, tensile strength, and environmental adaptability. Furthermore, the application of cross hybrid abaca may help reduce losses caused by the viruses. However, cross hybrid abaca requires more tests, trials, and studies to verify and further identify its potentials in the industry and the market. In addition, it was noted that some abaca hybrids such as the Daratex have low fiber recovery due to their low tensile strength.

Genetically modified abaca is more resistant to ABTV. However, the fiber quality is still inconclusive (PhilFIDA, n.d.). Both hybrid and genetically modified are neither strong enough nor have enough reliable studies. Additional issues for genetically modified abaca would also include sustainability and production cost. More studies are needed to properly identify characteristics and the results of existing studies are inconclusive. With this, genetically modified abaca is currently not a viable

option. A lot of the current information and research regarding its characteristics, among others, are theoretical and therefore may be faulty.

3.2 Other Issues Related to Abaca

The abaca virus can cause damage to the plant, reducing its production quality and economic viability. Using resistant varieties would be the best way to control the effects of diseases, yet it should be the same standard as the current abaca types. Currently, traditional varieties are still recommended, as with the results of the survey. However, traditional varieties are more susceptible to ABTV, due to the environment than conventional farming practices create, i.e., a breeding ground for insects. These can still be managed with recommended practices, like regular cleaning and fertilization. Otherwise, depletion of the topsoil and its fertility may occur.

Some reasons as to why abaca diseases occur would be that: an infected cutting knife for all the plants, following “pohada” system, the attitude of farmers, and lack of knowledge and funding. These are all important issues, but temporary solutions are used instead, as abaca is an industrial crop.

Studies regarding genetically modified abaca have inconclusive results (PhilFIDA, n.d.), and nothing has been developed for commercial use. At present, there are still negative connotations with farmers regarding genetically modified and hybrid abaca due to a previous issue with these. Additional issues include fiber quality, resistance traits stability, etc. Cross hybrid abaca types cannot also be mass-produced, for similar reasons. According to a respondent, one hybrid type was introduced in the 1990s called Daratex, which incurred many issues, such as cooking fiber batches. The industry suffered due to losses encountered.

3.3 Economic Benefits and Sustainability

Currently, it is believed that traditional abaca would provide more benefits in the long run. More studies may be needed to answer the question more objectively, as there is more information

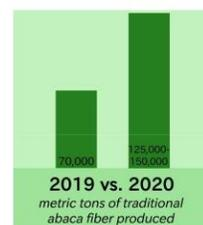

Figure 2. A comparison of the production of abaca fiber in 2019 and 2020.



regarding traditional abaca than either cross hybrid or genetically modified abaca. Foreign buyers, who constitute a significant amount of the market, are against hybrid or genetically modified types. Furthermore, traditional abaca has been used since the 1900s, and it has been helping the country's economy consistently.

In 2019, over 70,000 metric tons of traditional abaca were produced. The demand in 2020 was around 125,000 to 150,000 metric tons. Exports of abaca fiber and manufacture also generated an average of US\$97.1 million per year in the last decade (Department of Agriculture, 2019). Additionally, abaca is sought after as a raw material as it is sustainable: it can replace synthetic, plastic, and petroleum-based products; it is more sustainable than wood pulp. Abaca causes relatively fewer environmental problems than typically used materials as it does not disturb weather patterns.

Neither cross hybrid types nor genetically modified types have been properly propagated in the market. A respondent stated that the Bandala hybrid can be used for its virus resistance, have a high production level if propagated, and can be used to produce textile products, similar to traditional abaca. According to another respondent, it is too early to introduce abaca hybrids, not while it is inferior to traditional abaca.

3.4 Production and Growth

Traditional abaca may be best suited to the environment, as new hybrids have not yet gone through multilocational trials. It was also stated that the Bandala hybrid might also thrive in the Philippine environment, though there have been no proper conclusions regarding this. Abaca is location-specific; different varieties are recommended for different areas. In general, it can survive and thrive in the country's environment. Abaca also requires partial shade. However, they thrive on well-drained fertile soil, mountains and interlands, with type II, III, and IV climates, as well as areas rich in volcanic soil (PhilFIDA, n.d.).

Additionally, the mindset of farmers regarding the plants must be changed. Many farmers lack information regarding modern techniques (Waller et al., 2019). They should adapt to modern and proper farming practices such as fertility maintenance as traditional abaca is self-sustainable to reproduce.

Currently, there is insufficient information and data to determine the abaca type with more efficient and cost-effective production. One reason would be that both hybrids and genetically modified types have restricted market access. Traditional abaca can produce more as hybrid abaca is easily broken, with a low chance of recovery. According to

another respondent, the abaca with the more efficient and cost-effective production type would be varieties with low-quality fibers, especially wild and hybrid species, as the production cost would be lower.

Fibers are the ultimate product of abaca. Several factors affect fiber quality, such as the method of stripping, blade used, etc. Hybrid abaca has a lower fiber recovery since the tensile strength is lower compared to traditional abaca. Much fiber is broken while stripping, and more effort is required to produce the same amount of hybrid fiber with traditional abaca fiber. Genetically modified abaca elseways, shows inconclusive results on its data on fiber quality and abaca yield (PhilFIDA, n.d.). More studies or trials are needed to assess the properties of the genetically modified abaca and its fiber.

4. CONCLUSIONS

It was determined that traditional abaca is a more viable option in the market due to it being of higher quality compared to the other abaca types despite issues in its vulnerability against diseases. This vulnerability can be remedied with proper sanitation, cleaning practices, detection of the abaca viruses, and application of modern agricultural practices. The usage of crossbred abaca and genetically-modified abaca could help prevent significant financial losses led by the viruses and improve the fiber quality and yield; however, further tests and trials are needed to determine the capabilities of the crossbred and genetically modified abaca varieties.

The survey only had a limited number of respondents and it is recommended to conduct similar studies in the future. To solve issues in the abaca industry, political leaders, abaca farmers, researchers, and the general public should be educated on the importance and potential of abaca through seminars, online campaigns, training programs, and conferences. A respondent had also addressed the importance of modern applications in agriculture for abaca farming. Abaca farmers should also be educated regarding the issues of the traditional abaca and the abaca industry. This would include identification of infected plants, implementation of proper farming practices, among other information. Raising awareness on the issues should also be promoted to the general public, the government, and people in positions of power through seminars, online campaigns, training programs, and conferences. The spreading of the virus could be prevented this way.

For the industry to improve, it would be recommended that experts set and evaluate reasonable goals for the industry. If previously used methods do not work, then new methods and strategies should be used. People involved in the



industry should be actively engaged in it as well for the industry to thrive. More studies regarding cross hybrid and genetically modified abaca should be conducted. Additionally, political leaders, researchers, and farmers should be educated about the abaca hybrids' agronomic and economic potential. This could be a way to reduce the stigma and misconceptions that surround hybrid and genetically modified abaca in the market.

5. ACKNOWLEDGMENTS

We would like to extend our deepest gratitude to our research adviser, Ms. Chona Abeledo, for her continuous guidance and support throughout the year. We offer our sincere appreciation for the learning opportunities and lessons given and imparted to us. The completion of this research could have not been completed without the support of our family and friends. Your encouragements have provided comfort when times get rough and it was a great relief to know that you were by our side.

6. REFERENCES

Arcalas, J. (2018). Market demand, competition test strength of PHL's abaca. *Business Mirror*. <https://businessmirror.com.ph/2018/02/27/market-demand-competition-test-strength-of-phls-abaca-3/>

Armezin, R., Sinon, F. G. & Moreno, L. O. (2015). Abaca fiber: a renewable bio-resource for industrial uses and other applications. In *Biomass and Bioenergy Applications*. (107-118). <https://doi.org/10.1007/978-3-319-07578-5>

Boguero, A. P. B., Parducho, M. A. L., Mendoza, M. R. D. R., Abustan, M. A. M., & Lalusin, A. G. (2016). Molecular Screening of Abaca (*Musa textilis* L. Nee) Accessions Using Microsatellite Markers Associated With Resistance to Bunchy Top Virus. *Philippine Journal of Crop Science*, 41(2), 13–19. <https://www.cabi.org/gara/FullTextPDF/2016/20163306766.pdf>

Bureau of Agriculture and Fisheries Standards. (2016). Abaca fiber-Grading and Classification-Hand-stripped and Spindle/ Machine-stripped. <http://www.philfida.da.gov.ph/images/Publications/PNS/PNSBAFS1802016AbacaFiberHandstrippedandMachineStripped.pdf>

Bureau of Agriculture and Fisheries Standards. (2019). Non-food crops – Abaca – Code of Good Agricultural Practices (GAP). <http://www.philfida.da.gov.ph/images/Publications/PNS/PNS-Non-food-Abaca-GAP.pdf>

Dancel, R. R. (2018). Abaca Fiber as a Retrofitting Material. *Proceedings of Researchfora International Conference*, August. https://www.researchgate.net/publication/328900481_Abaca_Fiber_as_a_Retrofitting_Material

Dapar, L. (2014). Socio-ecological Analysis of Abaca Production in Biliran Island, Philippines. https://www.academia.edu/38147362/Socio_ecological_AnalysisOfAbacaProduction ABSTRACT_pdf

De Castro, N. L., Sardido, M. L., Alino, J. B. J., & Deomampo, N. R. (1988). Abaca [industry in the Philippines]. *PCARRD Commodity Industry Analysis Series (Philippines)*. <https://agris.fao.org/agris-search/search.do?recordID=PH8910458>

Department of Agriculture. (2019). Philippine Abaca Industry Roadmap 2018-2022. <https://www.da.gov.ph/wp-content/uploads/2019/06/Philippine-Abaca-Industry-Road-map-2018-2022.pdf>

Department of Science and Technology. (2015). Improved abaca varieties to nail PH as top exporting country abaca: weaving more opportunities into farmers' lives. <http://www.dost.gov.ph/index.php/knowledge-resources/news/44-2015-news/746-improved-abaca-varieties-to-nail-ph-as-top-exporting-country-abaca-weaving-more-opportunities-into-farmers-lives>

Department of Science and Technology. (2020). DOST-FPRDI: ABACA HYBRID YIELDS QUALITY FIBER. <http://www.dost.gov.ph/knowledge-resources/news/67-2020-news/1832-dost-fprdi-abaca-hybrid-yields-quality-fiber.html>

Eroy, M.N. (2012). Productivity and Profitability of Abaca Varieties/Hybrids (*Musa textilis* Nee) Under Mature Tall Coconuts in Davao City, Southern Mindanao, Philippines. *CORD*, 28(2), 9. <https://doi.org/10.37833/cord.v28i2.101>

Felix, R. (2006). Genetic engineering eyed to solve problems of ailing abaca industry. *The Philippine Star*. <https://www.philstar.com/business/agriculture/2006/04/02/329400/genetic-engineering-eyed-solve-problems-ailing-abaca-industry>

Fernandez, A., Torre, R., Fabon, M., & Lalusin, A. (2016). Growth and Fiber Yield of Abaca Hybrids Under Compostella Valley Province, Philippines Condition. CreateSpace Independent Publishing Platform. https://www.researchgate.net/publication/337559760_GROWTH_AND_FIBER_YIELD_OF_ABACA_HYBRIDS_UNDER_COMPOSTELLA_VALLEY_PROVINCE_PHILIPPINES_CONDITION

Fernandez, R. (2018). DOST finds abaca, other fibers viable for banknotes. *The Philippine Star*. <https://www.philstar.com/headlines/2018/08/13/1842083/dost-finds-abaca-other-fibers-viable-banknotes>

Food and Agriculture Organization of the United Nations. (2013). Abaca. *Future Fibers*. <http://www.fao.org/economic/futurefibres/fibres/abaca>

Hayase, S. (2018). Manila Hemp in World, Regional, National, and Local History. *Journal of Asia-Pacific Studies*, 171–188.

Lalusin, A. (2010). Abaca Breeding for a More Reliable Philippine Abaca Industry. *Annual BSP-UP Professorial Chair Lectures*. Manila; Malate. http://www.bsp.gov.ph/events/2010/pls/downloads/BSP_5a_lalusin.pdf

Lalusin, A. G., & Villavicencio, M. L. H. (2015). Abaca (*Musa textilis* nee) breeding in the philippines. In *Industrial Crops: Breeding for Bioenergy and Bioproducts* (pp. 265–289). Springer New York. https://doi.org/10.1007/978-1-4939-1447-0_12

Lee, G. (1920). Abaca (Manila hemp): The Fiber Monopoly of the Philippine Islands. *The Scientific Monthly*, 11(2), 159-170. <https://www.jstor.org/stable/6637>



- Miraflor, M. B. (2017). Abaca fiber for the country's paper bills? <https://business.mb.com.ph/2017/06/18/abaca-fiber-for-the-countrys-paper-bills/>
- Mousavi, S. R., & Eskandari, H. (2011). A General Overview on Intercropping and Its Advantages in Sustainable Agriculture. *Journal of Applied Environmental and Biological Sciences*, 1(11), 482–286. https://www.researchgate.net/publication/220000362_A_General_Overview_on_Intercropping_and_Its_Advantages_in_Sustainable_Agriculture
- Noriega, R. (2020). DOST-FPRDI researchers discover 'Bandala' abaca hybrid yields high quality fiber. *Manila Bulletin*. <https://mb.com.ph/2020/06/08/dost-fprdi-researchers-discover-bandala-abaca-hybrid-yields-high-quality-fiber/>
- Ocfemia, G. O. (1930). Bunchy-Top of Abaca or Manila Hemp I. A Study of the Cause of the Disease and Its Method of Transmission. *American Journal of Botany*, 17(1), 1-18. <https://doi.org/10.2307/2446376>
- Panela, S. (2013). PHL researchers looking into developing abaca for nanotechnology. *GMA News*. <https://www.gmanetwork.com/news/scitech/science/341825/phl-researchers-looking-into-developing-abaca-for-nanotechnology/story/>
- Parac, E. P., Lalusin, A. G., Pangga, I. B., & Filomena, F. C. (2020). Characteristics of selected hybrids of abaca (*Musa textilis* nee) with resistance to bunchy top. *Philippine Agricultural Scientist*, 103(1), 1–12. https://www.researchgate.net/publication/349345665_Characteristics_of_Selected_Hybrids_of_Abaca_Musa_textilis_Nee_with_Resistance_to_Bunchy_Top
- Pelzer, K. J. (1948). The Philippine Abaca Industry. *Far Eastern Survey*, 17(6), 71–74. <https://doi.org/10.2307/3022719>
- Philippine Fiber Industry Development Authority. (2014). *Abaca Sustainability Manual*. <http://www.philfida.da.gov.ph/images/Publications/abacasustainabilitymanual/ASM.pdf>
- Philippine Fiber Industry Development Authority (n.d.). *Philippine abaca help in global conservation*. Department of Agriculture. <http://www.philfida.da.gov.ph/index.php/archived-articles/19-philippine-abaca-helps-in-global-environment-conservation>
- Philippine Fiber Industry Development Authority. (2013). *The Philippine Abaca Industry Roadmap 2018-2022 . THE PHILIPPINE ABACA INDUSTRY ROADMAP 2018-2022* (pp. 1–129). Cebu: Philippine Fiber Industry Development Authority.
- Saragih, S. W., Lubis, R., Wirjosentono, B., & Eddyanto. (2018). Characteristic of abaca (*Musa textilis*) fiber from Aceh Timur as bioplastic. *AIP Conference Proceedings*, 2049. <https://doi.org/10.1063/1.5082463>
- Shahri W., Tahir I., Ahad B. (2014) Abaca fiber: a renewable bio-resource for industrial uses and other applications. *Biomass and Bioenergy*. Springer, https://doi.org/10.1007/978-3-319-07641-6_3
- Siddaway, A. P., Wood, A. M., & Hedges, L. V. (2019). How to Do a Systematic Review: A Best Practice Guide for Conducting and Reporting Narrative Reviews, Meta-Analyses, and Meta-Syntheses. In *Annual Review of Psychology* (Vol. 70, Issue 1, pp. 747–770). Annual Reviews Inc. <https://doi.org/10.1146/annurev-psych-010418-102803>
- Simbaña, E. A., Ordóñez, P. E., Ordóñez, Y. F., Guerrero, V. H., Mera, M. C., & Carvajal, E. A. (2020). Abaca. In *Handbook of Natural Fibres* (pp. 197–218). Elsevier. <https://doi.org/10.1016/b978-0-12-818398-4.00008-6>
- Sinha, A.K., Bhattacharya, S. & Narang, H.K. (2021). Abaca fibre reinforced polymer composites: a review. *J Mater Sci* 56, 4569–4587. <https://doi.org/10.1007/s10853-020-05572-9>
- Teramoto, N., Urata, K., Ozawa, K. & Shibata, M. (2004). Biodegradation of aliphatic polyester composites reinforced by abaca fiber. *Polymer Degradation and Stability*. 86(3), 401-409 <https://doi.org/10.1016/j.polymdegradstab.2004.04.026>
- Valdabella, M. M. (2016). *Upgrading Abaca Industry through New Hybrid Varieties*. <https://www.bar.gov.ph/index.php/digest-home/digest-archives/771-2016-2nd-quarter/5833-upgrading-abaca-industry-through-new-hybrid-varieties>
- Viesca, H. M. (2020). UPLB symposium on PH abaca fiber raises aid for abaca farmers in typhoon-hit Catanduanes. *OVCRE*. <https://ovcre.uplb.edu.ph/press/news/item/558-uplb-symposium-on-ph-abaca-fiber-raises-aid-for-abaca-farmers-in-typhoon-hit-catanduanes>
- Vilaseca, F., Valadez- Gonzalez, A., Herrera-Franco, P., Pélach, M., López, J. & Mutjé, P. (2009). Biocomposites from abaca strands and polypropylene. part I: evaluation of the tensile properties. *Bioresource Technology*. 101(1), 387-395 <https://doi.org/10.1016/j.biortech.2009.07.066>
- Waller, V., & Wilsby, A. (2019). Abaca in the Philippines, an overview of a potential important resource for the country: Relating the tensile strength of the single fiber to the microfibrillar angle. <http://www.diva-portal.org/smash/get/diva2:1352495/FULLTEXT01.pdf>



Zoologists on the Move: Mga Karanasan, Hamon, at Motibasyon ng mga Zoologists edad 25-50 sa Metro Manila

Eunice Gabrielle A. Galimpin and Natalie Teresita Romualdez
Assumption College San Lorenzo, Makati City

Abstrak: Ang pananaliksik na ito ay tungkol sa danas ng mga *zoologists* sa Metro Manila. Binigyang pansin dito ang pangkalahatang danas, hamon, at motibasyon ng mga kalahok. Ang pananaliksik ay isinagawa gamit ang penomenolohikal na disenyo ng pag-aaral. Pinili ang labing-isang (11) kalahok gamit ang *Purposive Sampling* teknik. Bumuo rin ng Patnubay na Talatanungan na naglalaman ng dalawampung (20) tanong na ginamit sa isinagawang pakikipanayam. Batay sa pagsusuri ng mga mananaliksik, nakita na ang mga karaniwang karanasan ng mga *zoologists* ay ang pagsasagawa ng mga eksperimento sa *field site* o laboratoryo, ang paggawa at pagbabahagi ng mga pananaliksik nila, at pagtuturo sa mga nais maging isang *zoologist*. Ang mga hamon naman na kinaharap nila ay ang mga panganib na nakakasalubong nila tuwing nagsasagawa sila ng *fieldwork* at ang kakulangan ng suporta at kamalayan ng gobyerno at ng mga lokal na tao. Samantala, ang nagsisilbing motibasyon nila ay ang mga oportunidad at gantimpala na natatanggap nila sa trabaho, mga panlabas na impluwensya kagaya ng mga *advisers* at magulang nila, ang kanilang mga adbokasiya, iba't ibang batayan ng pagpili nila ng trabaho, at ang kanilang relihiyon. Sa kabuuan, hindi naging madali ang mga karanasan ng mga *zoologist*, gayunpaman patuloy nila itong ginagawa dahil sa mga taong nakapaligid sa kanila at mga benepisyong kanilang natatanggap.

Susing Salita: hamon; hayop; karanasan; motibasyon; *zoologist*

1. INTRODUKSIYON

Ayon sa *Commission on Higher Education* (CHED) ng Pilipinas, ang *Natural Sciences* na kurso, kabilang na ang *Zoology* ay nakatanggap ng 31,188 na mag-aaral sa buong Pilipinas, subalit, 8,693 lamang ang nakapagtapos sa kursong ito noong 2018 hanggang 2019. Kapansin-pansin na wala masyadong mga pananaliksik tungkol sa buhay ng isang *zoologist* sa Pilipinas. Lahat ng mga pananaliksik na mayroong relasyon sa buhay ng mga *zoologists* ay tungkol lamang sa kanilang mga hamon. Ayon kina Stanhope, Carver, at Weinstein (2015), mahirap maging isang *entomologist*, dahil mas nanganganib ang kanilang buhay pagdating sa kanilang kalusugan. Bukod dito, hindi kaya ng mga *zoologists* ipahayag ang mga bago nilang kaalaman dahil hindi sila marunong makipag-usap sa ibang taong hindi bahagi ng kanilang larangan, at puro *jargon* lamang ang kanilang ginagamit (Johnson, 2009).

Ayon pa rin sa *Commission on Higher Education* (CHED) ng Pilipinas, ang *Medical at Allied* na kurso ay nakatanggap ng 215,234 na mag-aaral sa Pilipinas, at 42,425 ang nakatapos sa kursong ito. Kung ikukumpara ang mga mag-aaral na kumuha ng *Natural Sciences* at ang mga kumuha ng *Medical at Allied*, makikita ang malaking diperensya sa dalawang ito.

Kaugnay nito dahil sa kakulangan ng impormasyon at kamalayan tungkol sa kanila, nais ng mga mananaliksik na malaman ang mga karanasan, hamon, at kanilang motibasyon. Makatutulong ang pag-aaral na ito upang magkaroon ng mas malalim na kaalaman sa mga natatanging karanasan ng mga *zoologists*.

1.1 Mga Layunin ng Pag-aaral

Nakatuon ang pananaliksik na ito sa pag-aanalisa sa mga karanasan, hamon, at motibasyon ng ilang mga *zoologists* edad 25-50 sa Pilipinas.

Nais ng mga mananaliksik na masagot ang mga sumusunod na katanungan:

1. Ano ang karaniwang ginagawa ng isang *zoologist* sa trabaho, at mga halimbawa nito?
2. Ano ang mga hamon na nararanasan ng mga *zoologists* patungo sa kanilang trabaho?
3. Ano ang mga naging motibasyon ng mga respondenteng upang maging isang *zoologist*?

1.2 Saklaw at Limitasyon

Sakop ng pananaliksik na ito ang pagsusuri sa mga karanasan, hamon, at motibasyon ng *zoologists* sa Metro Manila. Nakatuon ang pag-aanalisa sa iba't ibang aspeto sa buhay-trabaho ng mga *zoologists*.

Nilimitahan ng mga mananaliksik ang pag-aaral na ito sa mga *zoologists* edad dalawampung't lima (25)



hanggang limampung (50) sapagkat mayroon na silang sapat na kaalaman at karanasan sa kanilang larangan. Ang mga *zoologists* ay manggagaling sa tatlong (3) na institusyon na ito: Unibersidad ng Pilipinas, Unibersidad ng Santo Tomas, at ang Pambansang Museo ng Pilipinas. Ang mga nasabing paaralan at museo ay ilan sa mga institusyon sa Metro Manila na mayroong departamento ng *Zoology* o kaya mayroong mga *zoologists* na sanay na sa kanilang trabaho.

2. METODOLOHIYA

2.1. *Disenyo ng Pananaliksik*

Ang pag-aaral na ito ay tungkol sa mga karanasan, hamon, at motibasyon ng mga *zoologists* sa Metro Manila. Ito ay isinagawa gamit ang penomenolohikal na disenyo. Tinangka nitong ilarawan ang danas ng mga *zoologists* sa Metro Manila.

2.2. *Mga Kalahok at Sampling Teknik*

Ang mga kalahok ay binubuo ng labing-isang (11) piniling *zoologists* (guro at *curator*) mula sa Unibersidad ng Pilipinas, Unibersidad ng Santo Tomas, at ang Pambansang Museo ng Pilipinas. Pinili ang mga kalahok gamit ang Purposive Sampling teknik.

2.3. *Instrumento ng Pag-aaral*

Ang instrumento ng pananaliksik na ginamit sa pangangalap ng mga datos ay ang Patnubay na Talatanungan. Naglalaman ito ng dalawampung (20) tanong na nagsilbing gabay sa isinagawang interbyu.

2.4 *Paraan ng Pagkakalap ng mga Datos*

Nagsimula sa pagbuo ng patnubay na talatanungan ang mga mananaliksik. Matapos itong maaprobahan at maipa-validate ay humanap ng 11 na mga potensyal na kalahok na siyang kinapanayam.

2.5 *Paraan ng Pagsusuri ng mga Datos*

Mula sa isinagawang pakikipanayam, sinuri ng mananaliksik ang mga sagot ng mga respondenteng *zoologists* na dalawampu't lima (25) hanggang limampung (50) taong gulang. Sinuri ang mga karanasan, hamon, at motibasyon nila sa pagtatrabaho batay sa mga nangingibabaw na tema.

3. RESULTA AT DISKUSYON

Batay sa isinagawang pagsusuri ang mga karaniwang gawain ng isang *zoologist* ay ang pagsasagawa ng mga eksperimento. Tuwing ginagawa nila ito, kadalasan na sa *field site* sila, o

nasa loob ng laboratoryo. Narito ang isa sa mga halimbawang verbatim: *“Sumasama din ako sa mga fieldwork ng museum and we try to collect snake samples, frog samples um in the field.”*

Isa rin sa mga karaniwang gawain nila ay ang paggawa at pagbabahagi ng mga pananaliksik. Ang mga nakuha nilang impormasyon galing sa mga eksperimento ay sinusuri, at ibinabahagi nila sa pamamagitan ng mga *publications* o sa mga kumperensya. Narito ang isa sa mga halimbawang verbatim: *“I presented some of our work in other countries. Yung most recently, or the best experience was when we went to Japan. So, we presented our work there. Uhhh, the, it was a conference, so the conference was, uhh, two days, two days.”*

Bukod dito, nagtuturo rin sila sa mga nais maging isang *zoologist*. Sapagkat maraming *zoologists* na nangangailangan magturo habang sila ay nagsasagawa ng mga pananaliksik. Narito ang isa sa mga halimbawang verbatim: *“So, I work in a university, so, for much of our time is spent teaching. So, we teach college students.”*

Batay naman sa resulta para sa mga hamong kinahaharap ng mga *zoologists* sa trabaho, isa dito ay ang mga panganib na nakakasalubong nila tuwing nasa *field site* sila. Sapagkat marami silang nararanasan sa *field* na maaaring makapinsala sa kanilang kalusugan at kaligtasan kagaya ng mga problema sa kalikasan, mga taong hindi nakauunawa sa trabaho nila, at iba pang mga kadahilanan na hindi nila makontrol. Narito ang isa sa mga halimbawang verbatim: *“In the Philippines, most probably mosquitos, noh, mas, mas nakakatakot pa sila kasi they can bring, uhhh, highly pathogenic or, uhhh, yun very dangerous, uhh, pathogens or viruses in their bodies like Dengue, Malaria, so... Elephantiasis, so yun, they can bring a variety of parasites or pathogens.”*

Isa ring hamong nararanasan nila ay ang kakulangan ng suporta at kamalayan ng gobyerno at ng mga lokal na tao. Dahil dito, ilan sa mga *zoologists* ay hindi nakagagawa nang maayos na pananaliksik. Kadalasan umaasa sila sa tulong galing ibang bansa upang magawa nila ang kanila trabaho na madalas hindi pinapansin ng mga Pilipino. Narito ang isa sa halimbawang verbatim *“It's-It's really hard to get funding from local agencies such as the government, they're very meticulous, and the government is not keen on, uhhh, basic research such as, uhhh, what we do. What the government wants, usually, is more on the applied, uhhh, side of research.”*

Batay naman sa makikitang resulta sa motibasyon ng mga *zoologists* pagdating sa kanilang trabaho, isa dito ay ang mga oportunidad at gantimpala. Sapagkat ito ay nagbibigay ng pagkilala at mga koneksyon sa mga nasa larangan nila. Narito



ang isa sa mga halimbawang verbatim: *“I’m quite pleased with fact na in the scientific circle, for instance, if they say sinong gumagawa ng research sa lakes sa Pilipinas? O sinong gumagawa ng research sa zooplankton sa Pilipinas? They would think of our lab. And then, for me, that’s enough, parang affirmation.”*

Isa ring motibasyon ng mga *zoologists* ay ang mga panlabas na impluwensya kagaya ng mga *advisers* nila, mga kasama nila sa trabaho, at magulang nila. Sila ay nagsisilbing motibasyon sapagkat ang mga taong ito ay naghihikayat sa kanila upang ipagpatuloy nila ang pagiging *zoologist*. Narito ang isa sa mga halimbawang verbatim: *“Yung mga naging professors ko, uhh, and they were instrumental in, uhmm, encouraging me to get into Herpetology or in the field of zoology.”*

Bukod dito, ang nag-uudyok din sa mga kalahok ay ang kanilang adbokasiya at ang mga batayan kung bakit nila pinili ang kanilang trabaho kagaya ng kanilang personal na interes mula kabataan, mga layunin nila sa buhay, at ang mga panloob na kadahilanan. Sapagkat ito ay nagpapalalim sa kanilang dedikasyon para sa kanilang trabaho. Narito ang isa sa mga halimbawang verbatim: *“I just wanna conserve this natural heritage that we have. So if we get to reach the goal, I mean what my goal is really to have more protected areas just to prevent extinction.” “Um, so since bata pa ako, I’ve been exposed sa environment so parang nag-start yun bilang camping activities and scouts.”*

Diskusyon

Ipinapakita sa resulta na ang karaniwang gawain ng mga *zoologist* ay nangyayari sa loob ng laboratoryo, *field sites*, at unibersidad. Ang mga gawaing isinasagawa sa loob ng laboratoryo ay DNA *analysis* at ang pag-opera at pag-obserba ng mga organismo. Ayon kay Sunderland (2012), ang mga gawain tulad ng pag-opera na kinakailangan para sa paglilipat ng mga nilalaman ng isang *amphibian* ay isinasagawa sa laboratoryo. Ang mga halimbawa naman ng mga gawain sa *field sites* ay ang pangongolekta ng mga sampol, paghahanap ng mga hayop, at ang mga panlabas na gawain katulad ng *camping* at *hiking*. Ang nakikitang mga *landscape* pagdating sa samahan ng hayop at ang kanilang kapaligiran ay nakatutulong sa perspektibong analitikal dahil pinapadali nito ang mga obserbasyon na maaaring dumagdag sa kaalaman ng mga *zoologist* (Sunderland, 2012). Ang huling karaniwang gawain ng isang *zoologist* ay ang pagtuturo ng *Zoology*. Bagaman hindi ito ang pangunahing trabaho nila, ito ay nakatutulong sa paghihikayat ng kanilang larangan. Ayon kay Hernawati, Amin, Irawati, Idriwati, at Aziz (2018), may mga guro ng *Vertebrate Zoology* na sinubukan ang pagsasama-sama ng mga *student teachers*, at natuklasan nila na may

magandang epekto ito sa kakayahan at kagalingan ng mga estudyante sa pag-aaral ng *Zoology*. Makikita rito na malaki ang impluwensya ng mga *zoologists* sa pagpapaunlad ng kanilang larangan kapag sila ay nagtuturo. Isa pa sa ginagawa ng mga *zoologist* habang nagtuturo ay ang pagsusulat at pagbabahagi ng mga akademikong papel.

Bukod sa mga karaniwang karanasan ng mga *zoologists*, ipinakikita rin ng resulta ang mga hamon na natuklasan ng mga *zoologists* sa trabaho. Isa sa mga hamon nila ay ang mga panganib na natagpuan habang ginagawa nila ang kanilang trabaho, lalo na sa pagsasagawa ng *fieldwork*. Kasama sa mga panganib na maaari nilang maranasan ay ang pagkakaroon ng sakit. Ayon kay Stanhope, Carver, at Weinstein (2015), ang mga *entomologists*, isang uri ng *zoologist*, ay nagkakaroon ng iba’t ibang uri ng sakit, lalo na sa balat. Nararanasan din nila magkaroon ng impeksyon at *delusional parasitosis*. Bukod pa rito, maraming hayop ay mayroong iba’t ibang uri ng *parasite*, kaya kinakailangang magkaroon ng kamalayan tungkol dito upang maiwasan ang pagkalat ng mga *endoparasite* at *zoonose* na ito (Dărăbuș, Afrenie, Hotea, Imre, & Morariu, 2014). Maliban sa mga sakit, maaari din silang makaranas ng iba pang problema sa *field site*. Ang mga halimbawa nito ay ang mga isyu sa kalikasan. Dahil dito, nahihirapan ang mga *zoologists* magsagawa ng *fieldwork* sapagkat konti nalang ang nakukuha nilang mga sampol. Ayon kay Batool at Hussain (2016), maraming dahilan tulad ng pagbabago ng klima, pagbaha, *deforestation*, at iba pang mga isyu na nakaaapekto sa kalikasan, at dahil dito, hindi kaya ng mga hayop mamuhay sa ganitong klaseng kapaligiran. Maliban sa mga hamong nararanasan nila tuwing *fieldwork*, nagkakaroon din sila ng mga paghihirap sa labas nito. Ang hamon na ito ay ang kakulangan ng suporta at kamalayan sa mga Pilipinong *zoologists*. Ayon sa resulta, mahirap maging isang *zoologist* sa Pilipinas sapagkat hindi sila gaanong sinusuportahan ng gobyerno. Sa taong 2020, ang badyet na ibinigay sa Kagawaran ng Agham at Teknolohiya, o mas kilala bilang *DOST* ay nabawasan. Ang dating 20.26 bilyong piso ay naging 20.18 bilyong piso na lamang. Bukod pa rito, ayon kay Lamberte (2018), 6.3 na porsyento lamang ng buong badyet ng *DOST* ay ibinigay para sa sektor ng *research at development* (R&D) para sa taong 2019. Ipinakikita nito na hindi ito prayoridad ng gobyerno. Isa pang hamon na kinakaharap ng mga Pilipinong *zoologists* ay ang paghahanap ng trabahong pangmatagalan. Batay sa resulta, mahirap magkaroon ng trabaho sa larangang ito, maliban nalang kung propesor o guro ang nais maging ng isang nagtapos ng Dalubhayupan o Haynayan. Ayon kay Russell (2009), maraming idinagdag na bagong impormasyon tungkol sa larangan ng *Zoology* pati na



rin ang pagdaragdag ng iba't ibang mga *subclass* sa *biology* ng hayop. Dahil dito, pabago-bago ang kurikulum ng *Zoology*.

Bagama't may kahirapan sa propesyong kanilang napili, isa sa mga naging motibasyon nila ay ang mga oportunidad o gantimpala na makukuha nila sa trabaho. Batay sa resulta, maaari silang makakuha ng *monetary rewards*, o kaya makapunta sa ibang bansa upang mailahad ang kanilang mga gawa. Sa pamamagitan ng pagtatanghal ng kanilang mga pananaliksik, ito ay nagbibigay ng karangalan sa kanila bilang isang *zoologist*. Batay sa pagsisiyasat nina Lucrezi, Milanese, Danovaro, at Cerrano (2017), pinili ng mga respondente nila na kunin ang kursong Haynayan dahil gustong nilang pumunta sa ibang bansa, at magsagawa ng pananaliksik. Maliban sa mga makukuhang oportunidad at gantimpala, isa pang motibasyon nila ay ang mga panlabas na impluwensya, kagaya ng mga *advisers*, mga magulang, at *role models* nila. Ayon kina Cake, McArthur, Mansfield, Zaki, Carbonneau, at Matthew (2019), isa sa mga pangunahing impluwensya sa pagkukuha ng trabaho kasama ang mga hayop ay ang mga hinahangaan nilang tao o matuturing nilang *role models*. Base rito, makikita na hinahangaan ng mga *zoologists* ang kanilang mga *advisers* at ang mga magulang nila. Bukod sa mga panlabas na impluwensya, ang nag-uudyok din sa mga *zoologists* ay ang kanilang adbokasiya at ang mga batayan kung bakit nila pinili ang kanilang trabaho kagaya ng kanilang personal na interes mula kabataan, mga layunin nila sa buhay, at ang mga panloob na kadahilanan. Ayon sa resulta, maraming kalahok ang nagsabing mahilig sila sa mga hayop, sa mga gawaing panlabas, pati na rin sa kalikasan. Ang mga interes na ito ay nagsisilbing motibasyon sapagkat nagbibigay ito ng ligaya sa kanilang buhay. Ayon sa pananaliksik nina Cake et al. (2019), karamihan ng mga naging motibasyon ng mga kalahok nila ay mayroong kaugnayan sa kahiligan at ang maagang pagkakalantad sa mga hayop. Ang ideya na ito ay lalong pinagtibay ni Michael Oldham, isang *herpetologist*. Ayon kay Oldham (2016), noong bata pa siya, naging interesado na siya sa mga hayop, sa partikular ang mga *amphibians* at *reptiles*. Dahil nalantad siya sa interes na ito sa murang edad, naging impluwensya ito upang maging isang *zoologist*. Ayon din sa isa pang pananaliksik nina Cake et al. (2019), mayroong anim na salik na nag-impluwensya sa mga respondente nila, at ang mga ito ay layuning panlipunan, *animal orientation*, bokasyonal na pagkakakilanlan, mga hamon at pagkatuto, *career affordances*, at *people orientation*. Batay sa mga salik na ito, makikita na mayroong kaugnayan sa mga naging motibasyon ng mga *zoologists* upang kunin at ipagpatuloy ang kursong Zoology. Ngunit, mayroong isang salik na hindi

nananggit, at ito ay ang relihiyon. Ayon kay Hernandez, Foley, at Beitin (2010), malaki ang naging impluwensya ng relihiyon sa mga respondente nila sa pagpili ng karera. Nararamdaman ng mga respondente nila ang patnubay ng Diyos habang sila ay nasa proseso ng pagdedesiyon.

4. KONGKLUSYON

Hindi naging madali ang pagiging isang zoologist sa Pilipinas sapagkat marami silang mga hamon na nararanasan. Katulad ng mga panganib na natatagpuan nila sa *field site* o kaya naman ang kakulangan ng suporta ng gobyerno o mga lokal na tao. Gayunpaman kumukuha sila ng inspirasyon sa mga taong sumusuporta sa kanila, mga oportunidad at gantimpala na natatanggap nila, at sa pagmamahal nila sa kanilang larangan.

5. PASASALAMAT

Taus-pusong pasasalamat ang aming ipinaabot sa mga sumusunod na indibidwal at tanggapan dahil sa mahahalagang tulong, kontribusyon at/o suporta tungo sa matagumpay na reyalisasyon ng pananaliksik na papel na ito:

1. Sa labing-isang (11) *zoologists* galing sa Unibersidad ng Pilipinas, Unibersidad ng Santo Tomas, at ang Pambansang Museo ng Pilipinas sa paglalaan ng panahon at sa matapat na pagsagot sa aming inihandang kwestyuner,
2. Sa mga awtor, editor at mga mananaliksik ng mga akdang pinaghanguan naming ng mahahalagang impormasyong aming ginagamit sa pagsulat ng una at ikalawang kabanata ng pananaliksik na papel,
3. Kay Bb. Anna Patricia Gerong (Research in Daily Life 1), Bb. Abbygale C. Pinca (Pagbasa at Pagsusuri ng iba't ibang Teksto tungo sa Pananaliksik), at G. Jemyr B. Garcia (Pagsulat sa Filipino sa Piling Larangan), mga masisigasig naming dalubguro na gumabay sa amin sa tamang hakbangin sa pagsulat at paggawa ng isang pananaliksik na papel,
4. Sa aming mga magulang at pamilya, sa pagtulong nila sa amin sa gramatika ng aming papel, at sa pagsuporta nila sa aming pananaliksik,
5. Sa mga kaklase namin, lalo na sa aming *class beadle*, sa pagpaalala tungkol sa mga *due dates* at sa pagsasagot ng aming mga tanong,
6. Sa Panginoong Diyos, sa pagdinig sa aming mga dalangin lalung-lalo na sa mga panahong gusto naming sumuko, at sa pagbigay ng pag-asang matapos namin ang pananaliksik na ito nang maayos sa itinakdang-panahon.

Muli, maraming-maraming salamat po.

Eunice Gabrielle A. Galimpin
Natalie Teresita Romualdez



6. MGA SANGGUNIAN

- Aryanti, F., & Suhaerah, L. (2019). The effectiveness of a field study on vertebrate zoology to improve the mastery of student concept. *International Conference On Biology And Applied Science (Icobas)*. doi: 10.1063/1.5115715
- Bagaria, A., & Sharma, A. K. (2015). A Knowledge and Practices study of health hazards among animal handlers in zoological gardens. *International Journal of Occupational Safety and Health*, 4(1), 1–4. doi: 10.3126/ijosh.v4i1.9146
- Batool, S., & Hussain, M. (2016). Wildlife in the perspective of environmental degradation: A review. *Journal of Entomology and Zoology Studies*, 4(5), 508-511. Mula sa <http://www.entomoljournal.com/archives/2016/vol4issue5/PartH/4-5-34-937.pdf>
- Cake, M., Mansfield, C., McArthur, M., Zaki, S., & Matthew, S. (2019). An Exploration of the Career Motivations Stated by Early-Career Veterinarians in Australia. *Journal of Veterinary Medical Education*, 46(4), 545–554. doi:10.3138/jvme.0717-093r
- Cake, M., McArthur, M., Mansfield, C., Zaki, S., Carbonneau, K., & Matthew, S. (2019). Challenging identity: development of a measure of veterinary career motivations. *Veterinary Record*. doi:10.1136/vr.105510
- Candrasekaran, S. (2014). Effectiveness of Synectics Techniques in Teaching of Zoology at Higher Secondary Level. *International Journal of Humanities and Social Science Invention*, 3(8), 37–40. Mula sa https://www.academia.edu/download/52421517/G0381037040Effectiveness_of_Synectics_Techniques_in_Teaching_of_Zoology_at_Higher_Secondary_Level.pdf
- Commission on Higher Education. (2019, Hunyo 30). Higher education enrollment by discipline group. Mula sa <https://ched.gov.ph/wp-content/uploads/2019-Enrollment-by-Discipline.pdf>
- Commission on Higher Education. (2019, Hunyo 30). Higher education graduates by discipline group. Mula sa <https://ched.gov.ph/wp-content/uploads/2019-Graduates-by-Discipline.pdf>
- Dărăbuș, G., Afrenie, M., Hotea, I., Imre, M., & Morariu, S. (2014). Endoparasites In Mammals From Seven Zoological Gardens In Romania. *Journal of Zoo and Wildlife Medicine*, 45(2), 239–246. doi: 10.1638/2012-0170.1
- Dubois, A. (2011). The International Code of Zoological Nomenclature must be drastically improved before it is too late. *Bionomina*, 2(1), p. 1–104. doi: 10.11646/bionomina.2.1.1
- Find University. (n.d.). BS in Zoology in the Philippines. Mula sa <https://www.finduniversity.ph/majors/bs-in-zoology-philippines/>
- Hernandez, E. F., Foley, P. F., & Beitin, B. K. (2010). Hearing the Call: A Phenomenological Study of Religion in Career Choice. *Journal of Career Development*, 38(1), 62–88. doi:10.1177/0894845309358889
- Hernawati, D., Amin, M., Irawati, M., Indriwati, S., & Aziz, M. (2018). Integration of Project Activity to Enhance the Scientific Process Skill and Self-Efficacy in Zoology of Vertebrate Teaching and Learning. *EURASIA Journal of Mathematics, Science and Technology Education*, 14(6). doi:10.29333/ejmste/89940
- Johnson, K. (2009). The Return of the Phoenix: The 1963 International Congress of Zoology and American Zoologists in the Twentieth Century. *Journal of the History of Biology*, 42(3), p. 417-456. doi: 10.1007/s10739-008-9160-1
- Koene, J. (2012). Editorial: Zoology is dead, long live zoology! *Animal Biology*, 62(4), 379-380. doi:10.1163/15707563-00002403
- Lamberte, M. (2018). Department of Science and Technology FY 2019. Mula sa Congressional Policy and Budget Research Department website: https://cpbrd.congress.gov.ph/images/PDF%20Attachments/ABN/ABN2018-22_DOST.pdf
- Lucrezi, S., Milanese, M., Danovaro, R., & Cerrano, C. (2017). “Generation Nemo”: motivations, satisfaction and career goals of marine biology students. *Journal of Biological Education*, 1–15. doi:10.1080/00219266.2017.1385509
- Mauldin, M., Doty, J., Nakazawa, Y., Emerson, G., & Carroll, D. (2016). The Importance of Mammalogy, Infectious Disease Research, and Biosafety in the Field. *Journal of Parasite Biodiversity*, 3, p. 1-9. Mula sa https://www.researchgate.net/publication/307940544_The_Importance_of_Mammalogy_Infectious



- [_Disease_Research_and_Biosafety_in_the_Field/ink/57d2caa608ae601b39a41c61/download](#)
- National Museum of the Philippines. (2014). Important recognitions awarded to members of the Zoology Division. Mula sa <https://www.nationalmuseum.gov.ph/nationalmuseumbeta/Zoology/ZoologyQuest.html>
- National Museum of the Philippines. (2014). Role of the Zoology division. Mula sa <https://www.nationalmuseum.gov.ph/nationalmuseumbeta/Zoology/ZoologyRole1.html>
- National Museum of the Philippines. (2014). Turning Points. Mula sa <https://www.nationalmuseum.gov.ph/nationalmuseumbeta/Zoology/ZoologyHistory2.html>
- Oldham, M. (2016). Ramblings and Recollections from a Career in Herpetology. *The Canadian Herpetologist*, 6(2), p. 13-22. Mula sa https://www.researchgate.net/publication/325742252_Ramblings_and_Recollections_from_a_Career_in_Herpetology
- Russell, A. (2009). Situating and teaching 21st century zoology: revealing pattern in the form and function of animals. *Integrative Zoology*, 4(3), p. 309–315. doi: 10.1111/j.1749-4877.2009.00165.x
- Shalaby, I., El-Shenawy, N., Ghobasy, M., & Mohammadein, A. (2011). Enhancement the teaching and learning methods of some zoological courses (invertebrate, parasitology and animal physiology) in Taif University, KSA. *Journal of American Science*, 7(2), p. 232-238. Mula sa https://www.researchgate.net/publication/230815612_Enhancement_the_teaching_and_learning_methods_of_some_zoological_courses_invertebrate_parasitology_and_animal_physiology_in_Taif_University_KSA
- Stanhope, J., Carver, S., & Weinstein, P. (2015). The risky business of being an entomologist: A systematic review. *Environmental Research*, 140, p. 619-633. doi:10.1016/j.envres.2015.05.025
- Sunderland, M. E. (2012). Collections-Based Research at Berkeley's Museum of Vertebrate Zoology. *Historical Studies in the Natural Sciences*, 42(2), 83-113. doi:10.1525/hsns.2012.42.2.83
- Ulicsni, V., Babai, D., Vadász, C., Vadász-Besnyői, V., Báldi, A., & Molnár, Z. (2018). Bridging conservation science and traditional knowledge of wild animals: The need for expert guidance and inclusion of local knowledge holders. *Ambio*. doi:10.1007/s13280-018-1106-z
- Wit, L. (2020). *Zoology*. World Book Student. Mula sa <https://worldbookonline.com/student-new/#/article/home/ar617440/zoology>
- Yermekbayeva, A. T., Shaimerdenova, G. Z., Ziyaeva, G., Kaliyeva, A. K., Yessimov, B. K., Childibayev, J. B., ... Sergazynova, M. S. (2018). Implementation of New Approaches to Zoology and Ecology Teaching Based on the Bioecology of Snakes and Sarcosporidia Course. *Ekoloji*, 27(106), p. 249–255. Mula sa <http://www.ekolojidergisi.com/download/implementation-of-new-approaches-to-zoology-and-ecology-teaching-based-on-the-bioecology-of-snakes-5357.pdf>



The Effect of Spent Coffee Grounds to the Growth of *Solanum lycopersicum* (Tomato)

Romar A. Baranda, Alliyah Roma dR. Cada, Jan Daniel H. Carola,
and Chelsea Len M. Rodolfo

De La Salle University Laguna Campus, Biñan City, Laguna

Abstract: Six billion tonnes of spent coffee grounds (SCG) are thrown untreated into landfills, leading the spent coffee grounds to leach organic pollutants that may potentially harm bodies of water and emit methane, a greenhouse gas, into the atmosphere. Studies have confirmed that the ratio of carbon and nitrogen (C: N) of SCG is ideal for plant fertilizers. This study focused on determining the effects of SCG on the growth of tomato plants using four parameters: the number of leaves, the average leaf surface area, and the relative growth rate. The study used an experimental research design to study the causal relationship between SCG treatments and plant growth. Tomato seeds were grouped into four and sown on separate pots. The study used three trials, each containing different weights of SCG, namely: 0 g, 5 g, 9 g, and 14 g. The SCG treatments were applied after germination using the side-dressing method. The number of expanded leaves, leaf surface area, and relative growth rate of the tomato plants were observed every five days for 45 days. The researchers found that SCG treatments that exceeded SCG-5 displayed adverse effects on the growth of the tomato. Thus, the relative growth rate and SCG treatments of over 5 g are inversely related to one another. Results show that SCG-5 had the highest positive effect on plant growth in terms of all the parameters. The researchers can then conclude that SCG-5 is an effective alternative fertilizer that improves plant growth.

Key Words: tomato, spent coffee grounds, fertilizer, plant growth, ericaceous plant

1. INTRODUCTION

Solanum lycopersicum, commonly known as tomato, is an economically important and in-demand crop in the Philippines due to its versatility as a nutritious ingredient. This is clearly seen with the increased amount in terms of production in the country (Renna et al., 2018; Manzano & Mizoguchi, 2013). It is classified as an ericaceous plant, which thrives and grows better on soil with low pH, specifically with a 5.5 - 8.0 soil pH range, hence also being in favor of high acid fertilizers (Cubero & Baquiran, 2017).

Tomato has five growth stages, namely the germination stage (25 to 35 d), vegetative period (20 to 25 d), flowering stage (20 to 30 d), early fruiting stage (20 to 30 d), and mature fruiting stage (15 to 20 d). The number of days and success within each stage may vary depending on environmental conditions (Jones, 2013; Garcia et al., 2011). To produce and grow the standard requirements to achieve satisfactory results of plant growth, farmers usually resort to commercial fertilizers. However, the unnecessary overuse of these fertilizers results in increased soil salinity, metal accumulation, water eutrophication, and nitrate accumulation, leading to health hazards and the greenhouse effect (Savci, 2012). Therefore, a

need for organic and convenient alternatives is needed to reduce the environmental impact of commercial fertilizers.

Spent coffee grounds (SCG) are the primary solid residual material obtained during the coffee brewing process. When dumped into landfills, they leach high concentrations of organic pollutants into bodies of water, affecting the organisms that live there and emit methane, a greenhouse gas that causes global warming (Cruz et al., 2012; Cervera-Mata et al., 2017; Thenepalli et al., 2017). SCG is known to have a pH level between 6.5 to 6.8 (Coffee Grounds and Composting, n.d.). It has been studied as a potential fertilizing agent throughout recent years due to its nitrogen and potassium content, together with its carbon and nitrogen (C: N) ratios that are ideal for fertilizers (Caetano et al., 2014).

Fertilizers play the role of supplementing the essential nutrients of a plant in order to promote efficient plant growth (Purbatanji et al., 2019). The plant growth of a plant can be assessed in a cost-effective and non-destructive way by measuring its number of expanded leaves, average leaf surface area, and relative growth rate (RGR). The expanded leaves account for the total and average leaf surface area of the plant. Meanwhile, leaf area growth is considered



an essential parameter in determining plant productivity as it determines light interception activities. It is also directly correlated to the RGR or the change in mass per day (Wood & Roper, 2000; Paproki et al., 2012 as cited in Pound et al., 2014; Koester et al., 2014).

Thus, this study aims to assess the effects of SCG on the growth of *Solanum lycopersicum*. Specifically, in terms of the number of expanded leaves, average leaf surface area, and RGR using varying amounts of SCG namely 0 g, 5 g, 9 g, and 14 g.

2. METHODOLOGY

2.1. Planting of Tomato Seeds

The researchers bought tomato seeds from a local nursery. The seeds were first planted on seedling bags, each containing 30 g of topsoil from a local area around Silang, Cavite. The germination phase lasted for 41 d. Once germination is complete, one strong strand from each seedling bag was transplanted into their respective pots each containing 1 L of soil. Given that there were four treatments SCG-0, SCG-5, SCG-9, and SCG-14 with 0 g, 5 g, 9 g, and 14 g respectively, each replicated three times, there were a total of 12 experimental units or pots (see Fig. 1).



Fig 1. Tomato plots

2.2 Application of SCG Treatments

All SCG used was a mixture of *Coffea arabica* and *Coffea canephora* beans gathered from Cafe Agapita on the day of application. The SCG treatments were applied through side-dress application during the second week since the plants were transplanted (see Fig. 2). They were furrowed 2 in. deep and at least 2 in. away from the plant in a circle around each plant and covered with soil. Netting was also done by setting up the wooden planks apart from each other and covering them entirely with 0.4 mm x 0.7 mm small mesh nets. The researchers introduced the SCG to the plants three times in equal amounts in a fifteen-day interval.



Fig 2. Side-dress application of SCG Treatments

The plants were examined every five days for 45 days for the changes in the number of the expanded leaves, leaf surface area, and relative growth rate (RGR). All leaves on the plant, no matter how small, were counted for the number of expanded leaves. The researchers used ImageJ software (Fig. 3) to measure the leaf surface area of all leaves on each plant. This data was then used to determine whether there is an increase or decrease in the RGR of the tomato plants.

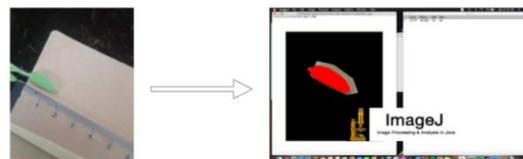

Fig 3. Leaf area measurement sample using ImageJ

3. RESULTS AND DISCUSSION

3.1 Number of Expanded Leaves

Fig. 4 shows the data on the number of expanded leaves collected over 45 days. The plants in SCG-9 have the highest number of leaves among the pots on the initial collection of data. However, an increase in the number of leaves on plants was seen on SCG-5 plants upon the second SCG application. Thus, SCG-5 garnered the highest number of leaves with 20 leaves leaving SCG-0 and SCG-9 with the second and third highest number of leaves and SCG-14 with the least number of leaves, 19 and 16 respectively.

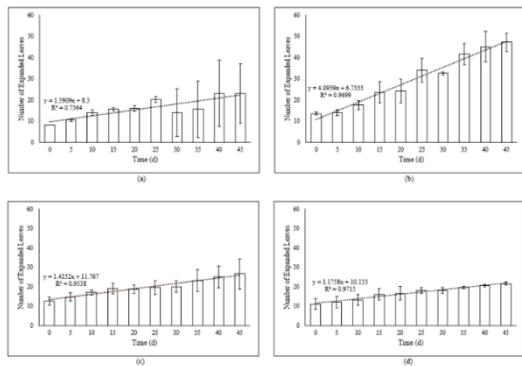

Fig 4. Average number of expanded leaves for (a) SCG-0, (b) SCG-5, (c) SCG-9, and (d) SCG-14.

After 15 d, a continuous increase was displayed by the plants in SCG-5. On the other hand, a slow rise in the growth of leaves in SCG-9 resulted in fewer leaves than SCG-0. SCG-5, followed by SCG-0, SCG-9, and SCG-14, displayed a decreasing trend in its number of expanded leaves which continued until the end of the data collection period.

A higher number of expanded leaves would, in turn, mean that SCG-5 observed the most considerable amount of growth (Wood & Roper, 2000). However, it is also worth noting that the control group, SCG-0, has the second-highest number of expanded leaves. This leaves a negative implication that greater amounts of SCG affect the emergence of leaves on the tomato plant.

The results imply that low concentrations of SCG applied are more effective in plant growth. This is evident by the data in the number of expanded leaves as SCG-5 showed the most significant increase in the number of expanded leaves.

3.2 Average Leaf Surface Area

Fig. 5 shows the average leaf surface area obtained on the 45th day of tomato plants grown in four varying SCG weights.

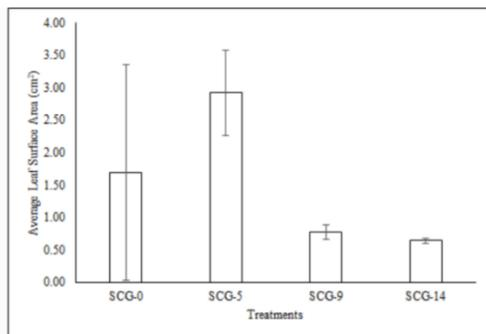

Fig 5. Average leaf surface area in respect to the amount of SCG at t = 45 d.

Upon the last day of data collection, SCG-5 had the highest average leaf area with a value of 2.92 cm². SCG-0 came second with an average leaf area of

1.69 cm², followed by SCG-9 with 0.77 cm², and last was SCG-14 with 0.64 cm².

The changes in leaf surface area may be due to varying environmental conditions such as climate, topography, and soils (Trimble, 2019). However, leaf surface area changes are more tightly related to soil nutrient status, specifically C: N ratios or N mineralization, than climate. Considering that the C: N ratios in SCG are ideal for fertilizers, the SCG is most likely to be the cause of the changes in leaf surface area (Gong & Gao, 2019; Ordonez et al., 2009; Caetano et al., 2014).

The plausible cause for affecting the soil nutrients status is overfertilization which may be rooted in the excessive amounts of fertilizer added at one time. The salinity of excessive SCG could have promoted the reduction of photosynthesis and an increase in leaf dehydration (Kozłowski et al., 1997; Ciesielczuk et al., 2018). Moreover, SCG may have caused high N-buildup in the soil that led to excessive vegetative growth, yet turning younger leaves into smaller sizes, delaying the growth of tomato plants (Sainju, Dris, & Singh, 2003). Thus, greater amounts of SCG applied resulted in lower leaf surface area values.

3.3 Relative Growth Rate

Fig. 6 shows the total leaf surface area of tomato plants treated with varying amounts of SCG throughout 45 d.

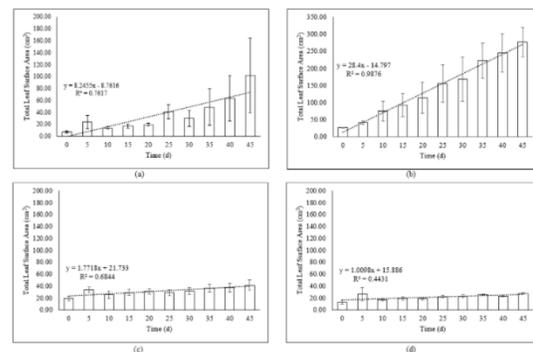

Fig 6. Total leaf surface area of (a) SCG-0, (b) SCG-5, (c) SCG-9, and (d) SCG-14.

Fig 6. Total leaf surface area of (a) SCG-0, (b) SCG-5, (c) SCG-9, and (d) SCG-14.

Table 1 summarizes the RGR of the tomato plants. The slope of the trendline for the total leaf surface area (as shown in Fig. 6) served as the RGR as it measures the change in total surface area, accounting for the mass of the plant, over the change in time.



Table 1. Relative growth rates of all treatments.

Treatment	RGR (cm ² /d)
SCG-0	8.2455
SCG-5	28.4
SCG-9	1.7718
SCG-14	1.0098

SCG-5 yielded the highest RGR among all the other SCG treatments with 28.4 cm²/d, followed by SCG-0, SCG-9, and SCG-14 with values 8.2455 cm²/d, 1.7718 cm²/d, and 1.0098 cm²/d, respectively.

From the data, the greater amount of SCG applied led to low RGR values. Factors that cause it may be the minerals and nutrients accumulated in the tomato plants as the incorporation of SCG increases the nitrogen, potassium, and phosphorus contents (Chrysargyris et al., 2020). As aforementioned in Section 3.2 of this paper, excess nutrient content is a sign of overfertilization resulting in the decline of the photosynthetic ability of the plant. Thus, creating smaller leaves, implying lower value for the mass of the plants, leading to the stunted growth rate of tomato plants. Moreover, overfertilization in potted plants also leads to very low or no plant growth at all (Worman, 2011).

4. CONCLUSIONS

Results for all parameters showed that SCG-5 had the best plant growth results compared to SCG-9 and SCG-14, which displayed signs of overfertilization. It also surpassed the growth of the tomato plant without any treatments of SCG, making SCG-5 a viable fertilizer for tomato plants. To further support this finding, the most appropriate amount of SCG to be applied from 0 to 8 g can be identified in order to determine the highest amount for maximum efficiency properly. Other stages and parameters of plant growth that were not assessed in this study due to its limitations can also be evaluated. Moreover, future researchers may explore different methods of SCG or fertilizer application as well.

5. ACKNOWLEDGMENTS

The researchers wish to express their sincere gratitude to Dr. Kerry P. Cabral for his continuous efforts in imparting his knowledge and expertise in this topic. This research would not have been successful if his help was neglected.

6. REFERENCES

- Caetano, N. S., Silva, V. F., Melo, A. C., Martins, A. A., & Mata, T. M. (2014). Spent coffee grounds for biodiesel production and other applications. *Clean Technologies and Environmental Policy*, 16(7), 1423-1430. <https://doi.org/10.1007/s10098-014-0773-0>
- Cervera-Mata, A., Pastoriza, S., Rufián-Henares, J. A., Párraga, J., MartínGarcía, J. M., & Delgado, G. (2017). Impact of spent coffee grounds as organic amendment on soil fertility and lettuce growth in two Mediterranean agricultural soils. *Archives of Agronomy and Soil Science*. <https://doi.org/10.1080/03650340.2017.1387651>
- Chrysargyris, A., Antoniou, O., Xylia, P., Petropoulos, S., & Tzortzakis, N. (2020). The use of spent coffee grounds in growing media for the production of Brassica seedlings in nurseries. *Environmental Science and Pollution Research*. <https://doi.org/10.1007/s11356-020-07944-9>
- Ciesielczuk, T., Rosik-Dulewska, C., Poluszyńska, J., Milek, D., Szewczyk, A., & Sławińska, A. (2018). Acute Toxicity of Experimental Fertilizers Made of Spent Coffee Grounds. *Waste Biomass Valor*, 9, 2157-2164. <https://doi.org/10.1007/s12649-017-9980-3>
- Coffee Grounds and Composting. (n.d.). Oregon State University. Retrieved March 20, 2021 from <https://extension.oregonstate.edu/gardening/techniques/coffee-grounds-composting#:~:text=Some%20information%20about%20coffee%20grounds&text=Grounds%20are%20not%20acidic%3B%20the,excellent%20nitrogen%20source%20for%20composting.>
- Cruz, R., Cardoso, M. M., Fernandes, L., Oliveira, M., Mendes, E., Baptista, P., . . . Casal, S. (2012). Espresso coffee residues: A valuable source of unextracted compounds. *Journal of Agricultural and Food Chemistry*, 60(32), 7777-7784. <https://doi.org/10.1021/jf3018854>
- Cubero, C. O. & Baquiran, P. B. (2017). Tomato production guide. Retrieved from http://rfo02.da.gov.ph/?smd_process_download=1&download_id=493
- García, M., Medrano, E., Sánchez-Guerrero, M., & Lorenzo, P. (2011). Climatic effects of two cooling systems in greenhouses in the Mediterranean area: External mobile shading and fog system. *Biosystems Engineering*, 108(2), 133-143. <https://doi.org/10.1016/j.biosystemseng.2010.11.006>



- Gong, H., & Gao, J. (2019). Soil and climatic drivers of plant SLA (specific leaf area). *Global Ecology and Conservation*, 20. <https://doi.org/10.1016/j.gecco.2019.e00696>
- Jones, J. B. (2013). Instructions for growing tomatoes: in the garden and greenhouse. Anderson, SC: GroSystems.
- Koester, R. P., Skoneczka, J. A., Cary, T. R., Diers, B. W., & Ainsworth, E. A. (2014). Historical gains in soybean (*Glycine max* Merr.) seed yield are driven by linear increases in light interception, energy conversion, and partitioning efficiencies. *Journal of experimental botany*, 65(12), 3311- 3321. <https://doi.org/10.1093/jxb/eru187>
- Kozlowski, T. T., & Pallardy, S. G. (1997). 7 - Cultural Practices and Vegetative Growth. In T. T. Perry & S.G. Pallardy (Eds.), *Growth Control in Woody Plants* (pp. 352-393). Academic Press. <https://doi.org/10.1016/B978-012424210-4/50007-3>
- Manzano, V. J., Jr., & Mizoguchi, M. (2013). Field Monitoring System and Analysis of Rainfall Data for Tomato Cropping Calendar in Batac City, Ilocos Norte, Philippines. *Journal of Nature Studies*, 12 (2), 11-17.
- Ordoñez, J. C., Bodegom, P. M., Witte, J. M., Wright, I. J., Reich, P. B., & Aerts, R. (2009). A global study of relationships between leaf traits, climate and soil measures of nutrient fertility. *Global Ecology and Biogeography*, 18(2), 137-149. <https://doi.org/10.1111/j.1466-8238.2008.00441.x>
- Pound, M. P., French, A. P., Murchie, E. H., & Pridmore, T. P. (2014). Automated recovery of three-dimensional models of plant shoots from multiple color images. *Plant Physiology*, 166(4), 1688-1698. <https://doi.org/10.1104/pp.114.248971>
- Purbatanji, E. D., Slamet, W., Fuskhah, E., & Rosyida. (2019). Effects of organic and inorganic fertilizers on growth, activity of nitrate reductase and chlorophyll contents of peanuts (*Arachis hypogaea* L.). *IOP Conf. Series: Earth and Environmental Science*, 250. <https://doi.org/10.1088/1755-1315/250/1/012048>
- Renna, M., Durante, M., Gonnella, M., Buttarò, D., D'Imperio, M., Mita, G., & Serio, F. (2018). Quality and nutritional evaluation of regina tomato, a traditional long-storage landrace of Puglia (Southern Italy). *Agriculture*, 8(6), 83. <https://doi.org/10.3390/agriculture8060083>
- Sainju, U.M., Dris, R. and Singh, B. (2003) Mineral Nutrition of Tomato. *Journal of Food, Agriculture and Environment*, 1, 176-183.
- Savci, S. (2012). An agricultural pollutant: Chemical fertilizer. *International Journal of Environmental Science and Development*, 3(1), 77-80. <https://doi.org/10.7763/IJESD.2012.V3.191>
- Thenepalli, T., Ramakrishna, C., & Ahn, J. W. (2017). Environmental effect of the coffee waste and anti-microbial property of oyster shell waste treatment. *Journal of Energy Engineering*, 26(2), 39-49. <https://doi.org/10.5855/ENERGY.2017.26.2.097>
- Trimble, S. (2019, April 16). Leaf Area - How & Why Measuring Leaf Area is Vital to Plant Research. Retrieved from <https://cid-inc.com/blog/leaf-area-how-why-measuring-leaf-area-is-vital-to-plant-research/>
- Wood, A. J., & Roper, J. (2000). A simple & nondestructive technique for measuring plant growth & development. *The American Biology Teacher*, 62(3), 215-217. <https://doi.org/10.2307/4450877>
- Worman, G. (2011, April 27). Over-Fertilization of Potted Plants. PennState Extension. <https://extension.psu.edu/over-fertilization-of-potted-plants>



Bibliometric Analysis on Biosensors and their Applications in Agriculture

Jericho Jacques Michael C. Fajardo, Julia Kirsten T. Singian, Jedrick Henricson C. Tan, Shoshannah B. Tiu, and Mark Christian Felipe R. Redillas
De La Salle University Integrated School, Manila

Abstract: Biosensors are systematic devices that detect signals from biochemical substances and convert them into quantitative data. They aid in preventing and diagnosing potential diseases and pathogens. The ease of use and accessibility of these devices has paved the way for many technological advancements, especially in the agricultural sector. In this study, the impact of piezoelectric, electrochemical, optical, and molecular biosensors in agricultural settings were analyzed using a bibliometric analysis software called VOSviewer. Various parameters and data sets such as biosensor trends, keyword relationships, and biosensor citation prevalence were used. The created maps showed that in the variable for co-authorship, Chinese authors were among the most prominent; while in the variable for co-occurrence: biosensor, agriculture, and biosensing techniques were among the top three words used; and in citation analysis for countries: China, United States, India, and Italy were the top countries with the most research and contribution in the field of biosensors. The results in this research will aid future studies and workings on biosensors by highlighting plausible trends and prospects in the field of research.

Key Words: plant biosensor; agriculture; farming; advancements; bibliometric

1. INTRODUCTION

Biosensors are scientific devices that produce optical, thermal, or electrical signals in proportion to their analyte by using biochemical reactions (Kumar & Upadhyay, 2018; Oluwaseun et al., 2018). Most biosensors consist of the following parts: analyte, bioreceptor, transducer, electronics, and display (Bhalla et al., 2016). There are distinct qualities that biosensors need to attain optimum performance levels, namely: selectivity, reproducibility, stability, sensitivity, and linearity. In farming, they are used in preventing and detecting diseases, crop pests, and pathogens (Oluwaseun et al., 2018; Bagde & Borkar, 2013). Moreover, this technology can aid in maximizing the quality of crops or products that farmers grow, as stated by Bhalla et al. (2016). For instance, biosensors could monitor the quality of the soil, water, and air of the surrounding areas by noting the pollutants present.

Biosensors are classifiable according to the method by which signal is transduced from the specimen to the device, e.g., optical, electrochemical, thermometric, piezoelectric, and magnetic (Damborský et al., 2016). Recently, there has been another biosensor aside from what was mentioned that is considered as emerging, known as molecular biosensors. The research addresses four classifications of biosensors: piezoelectric, electrochemical, optical, and molecular biosensors. Piezoelectric biosensors, or acoustic biosensors, utilize mechanical waves to detect

and obtain biochemical and biophysical information about the compound of interest. It detects changes in any physical property, e.g., mass elasticity and conductivity. Electrochemical biosensors can distinguish hybridized DNA, neuron tissue, bacteria, and enzyme reactions as biochemical events (Li et al., 2017), and convert these into electrical signals (Cho et al., 2020). Optical biosensors measure the responses of target analytes to illumination or light emission by utilizing various techniques. These techniques include light absorbance, reflectance, fluorescence, and more. Lastly, molecular biosensors utilize certain biochemical reactions moderated by biological materials, e.g., enzymes and cells, to detect chemical compounds through electrical, optical, or thermal signals (Campuzano, 2017). The research focuses on one specific type of molecular biosensor, the loop-mediated isothermal amplification (LAMP) biosensor.

Technological advancements in these devices have brought significant changes to the agricultural sector by playing a crucial role in protecting plant crops for quite some time. However, the gap in technological know-how and expensive developmental processes have hindered some countries from incorporating biosensors into the agricultural sector. Most of said countries are third-world countries where agriculture is still developing, and traditional farming methods are employed to maximize crop growth. If biosensor technology continues to advance, cheaper alternatives to current technology will emerge, giving



the marginalized agricultural sector the technological opportunity to improve crop production. With that being said, the need for cheaper alternatives for biosensor utilization and production requires further research and development.

This research is focused on biosensors often used in plant agriculture. The study aims to examine the importance of biosensors in plant crops, and to determine the trends of biosensor research according to the year they were published. Moreover, the roles, applications, and uses of biosensors in farming agriculture were explored and discussed. Hence, the results of this study serve as a basis for future research by means of highlighting the trends and important concepts of different biosensors used in plant agriculture. Recent studies about plant biosensors and their uses were also compiled and reviewed.

2. METHODOLOGY

2.1. Data Source

Scopus (<https://www.scopus.com>), is a bibliographic database containing a large variety of subject areas (E.g., Biochemistry, Arts and Humanities, Chemical Engineering, etc.). This navigation tool is generated by Elsevier, a Netherlands-based company, known for containing numerous published works from different publications and journals. This database was used as the primary bibliographic source for data and collecting articles relating to advancements or studies of biosensors for plant agriculture. The collected data, stored within a comma-separated value (CSV) file, was then processed through VOSviewer (ver. 1.6.15). CSV files collate data of different journal's various parameters from databases. These parameters include but are not limited to document title, authors, and DOI.

2.2. Data Collection

In the data mining and mapping, the search queries "agriculture AND biosensor" were used, and this premise only searches all journals with both words in the title or the abstract. The query string used was "TITLE-ABS-KEY (biosensor AND agriculture) AND DOCTYPE (ar) AND PUBYEAR > 2004", which translates to: articles with keywords "biosensor" and "agriculture" in the document title, abstract, or keyword, ranging from 2005 to present. The result yielded 153 documents in total. The "ar" in the query string denotes "article." Since the scope of this research is for the application of biosensors only in plants, the proponents checked each document to ensure the documents were suited only to plant agriculture. After thorough reviews, fifty-one (51) of

the documents were removed, most of which were related to human medicine and animal livestock.

2.3. Bibliometric Maps

VOSviewer is a software capable of creating visual aid maps that connect data through relations between keywords, authors, publications, research, etc. (Van Eck & Waltman, 2011). This software is utilized by a wide user base for establishing correlations amongst data from a pool of journals and articles, which may take form in a distance-based, graph-based, or timeline-based mapping system (Van Eck & Waltman, 2014). The map produced by VOSviewer will be based on the various parameters as mentioned previously, and may also be interpreted in several ways, i.e., size, color, distance, and connections of the data. Furthermore, these interpretations dictate the several aspects of the data (Van Eck & Waltman, 2020). For instance, size difference may determine the number of times a specific term appeared in the data, distance may determine degree relation, and connections may determine presence of a relation between terms.

The data sets were then organized using the bibliographic-data-based using VOSviewer mapping, which is based on the bibliographic data extracted from Scopus. Three types of analysis were employed: co-authorship, co-occurrence, and citation (country).

2.3.1. Analysis of Co-authorship

In the analysis of co-authorship, VOSviewer found 446 authors. However, counting manually, a total of 461 authors, most of which had the same surname and initial (e.g., Liu, X.) were found. Consequently, the map was created based on the initial finding of 446 authors, as that was the number recognized by VOSviewer.

2.3.2. Analysis of Co-occurrence

In the analysis of co-occurrence, "all keywords" were considered, i.e., both "author" and Scopus "index" keywords. Full counting method was employed, and a thesaurus was used to eliminate terms with identical definitions, plural forms, and irrelevance to the study, thus, excluding words such as "organo-phosphorus compound/organophosphorus compound," "soils/soil," and "article."

The minimum number of occurrences that were used was five (5), preventing irrelevant words from being added to the map. The parameters resulted in a total of 57 keywords, after eliminating words with less than five occurrences and words excluded and combined by the thesaurus.

2.3.3. Analysis of Citation

In this analysis of citations, the measured quantity is the countries involved in publishing the articles. The threshold for minimum number of publications was set to one (1), ensuring inclusivity of the available countries. The total number of countries resulting from this set parameter is 44.

3. RESULTS AND DISCUSSION

The researchers conducted bibliometric mapping based on three types of analysis: co-authorship, co-occurrence, and citation, and accordingly, used authors, all keywords, and countries, respectively. The maps produced will be described and analyzed through their physical attributes and characteristics such as size, clustering, color, and line thickness. The data extracted from Scopus were divided into five (5) distinct categories. The central search premise was “biosensor AND agriculture.”

3.1. Publication Growth Over the Past Years

From 2005-2020, there has been a significant growth in yearly publications about biosensors used in agriculture (Figure 1). In the years 2005-2010, the average number of publications was 2.67 articles a year. In 2016-2020, the average was 10.8, which indicated a 404.5% increase in mean publications per year. Kundu et al. (2019) attributed advancements in other fields of sciences such as material science and nanoengineering to the increased attention and production of journal articles in the field of biosensors.

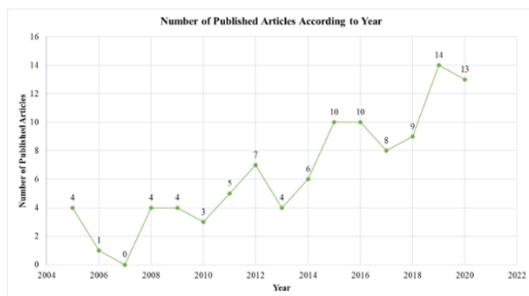

Fig. 1. Number of publications in the recent years from 2005-2020.

3.2. Co-authorship

For the search “biosensors” and “agriculture,” consisting of 102 documents, VOSviewer only identified 446 total authors. However, 461 total individuals were found responsible for authoring the 102 articles. Some authors such as Liu, Y., Liu, X., and Wang, Y. have the biggest nodes for the (Figure 2), and although this signifies more written works, it was found that these authors are different individuals.

However, other nodes showing the same size, such as He, H. and Wen, Y., signify an equal number of authored works.

The authors clustered are termed co-authors. A green cluster consisting of He, H., Wen, Y., etc. represents one article, while the pink cluster consisting of Pu, Y., Liang, G., etc. represents co-authors of another article. Bigger nodes, such as Liu, Y., Liu, X., and Wang, Y., are positioned to be proximally close to the authors they have worked with individually. According to the numerical data extracted from VOSviewer, Liu, Y. authored three articles; concurrently, three different authors named Liu, Y. were found to author the three different articles. The observations in color and line thickness show no significant role in identifying relations between the authors.

As mentioned, there were 446 total identified authors by VOSviewer. However, Figure 2 only represents a portion of the 446 authors since only the cluster with the most connection can be displayed. Other authors with high link strengths which are not connected to this big cluster are not shown in the map provided.

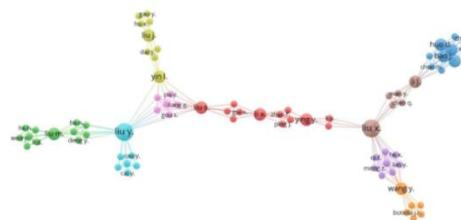

Fig. 2. Co-authorship mapping using VOSviewer.

3.3. Co-occurrence Variable

The top three most occurring keywords are biosensor, agriculture, and biosensing techniques (Figure 3). “Biosensor” and “agriculture”, being the search premises, were the highest with 69 and 40 occurrences, respectively. Node size is directly proportional to the frequency of the keyword, Figure 3 has clusters which are grouped into distinct colors: red, yellow, green, purple, and blue. The colors represent a common theme or relation among the words, as observed in a study performed by Briones-Bitar et al. (2020).

The observed theme among the clusters are as follows: agriculture and biosensing (keywords: “agriculture,” “biosensor;” red cluster), chemistry (keywords: “metabolism,” “limit of detection;” blue cluster), pesticides and words associated to chemicals (keywords: “acetylcholinesterase,” “organophosphate pesticide;” green cluster), chemical processes (keywords: “colorimetry,” “chemical detection;” yellow

cluster), and metals and other materials (keywords: “graphene,” “gold;” purple cluster).

The link strength of each keyword is attributed to the line thickness and size of its node. According to Md Khudzari et al. (2018), line thickness in the maps represent a higher link strength, and as observed, keywords such as biosensor and agriculture have thick lines running across the map and a link strength of 401 and 273, respectively.

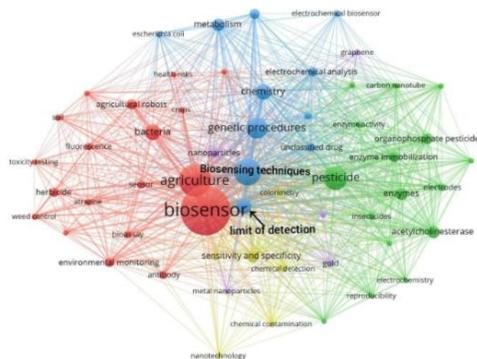

Fig. 3. Co-occurrence mapping from VOSviewer.

3.4. Country Variable

Countries mostly involved in the development and studying of biosensors in agriculture are highly developed countries. The countries with the most publications are China (24), United States (14), India (13), and Italy (13). The productivity of these countries is most likely a result of their high competitiveness and high funding allocation. China and India are two of the most populated countries in the world; hence, a large amount of agricultural production is required to support their country, which may explain the amount of effort they put into the pursuit of biosensor research.

The cluster or proximity of the nodes for Figure 4 indicate how closely countries work together in their research or how much the authors of each country cite each other’s work. India is located at the center of the map, which indicates extensive collaborations with its corresponding countries in the map such as China, Poland, and Italy.

Among the top four, India and China have the highest link strengths (8). These two countries have not only published several articles for biosensors, but also have collaborated with other countries. The thickness of the lines that connect them with other nodes are significantly thicker than other countries, which possibly reveal the great strides these two countries have taken to enhance the use of biosensors in agriculture.



Fig. 4. Citation mapping with VOSviewer.

4. CONCLUSIONS

Overall, the results from the bibliometric analysis through VOSviewer show that in the link for co-authorship, most authors were clustered to be Chinese. For co-occurrence, on the other hand, the top words were biosensors, agriculture, and biosensing techniques. The citations for the country variable section indicate the top three biosensing research to be China, India, and Italy, with the first two countries being in the same field of biosensor research. In the future, the possible research in biosensor use and study will be heavily focused on by developing and agricultural-focused countries which is a highly relevant explanation as to why China and other similar countries have a high biosensor research footprint. As research on biosensors progresses further, it is important to be able to determine the trends in keywords and uses in citations by different authors and countries in order to foresee the possible direction this research is heading for.

5. REFERENCES

Bagde, V. L., & Borkar, D. B. (2013). Biosensor: Use in Agriculture. *International Journal of Scientific Research: Biotechnology*, 2(10), 2–4. ISSN: 2277-8179

Bhalla, N., Jolly, P., Formisano, N., & Estrela, P. (2016). Introduction to biosensors. *Essays in Biochemistry*, 60(1), 1–8. <https://doi.org/10.1042/EBC20150001>

Briones-Bitar, J., Carrión-Mero, P., Montalván-Burbano, N., & Morante-Carballo, F. (2020). Rockfall research: A bibliometric analysis and future trends. *Geosciences (Switzerland)*, 10(10), 1–25. <https://doi.org/10.3390/geosciences10100403>

Campuzano, S., Yáñez-Sedeño, P., & Manuel Pingarrón, J. (2017). Molecular biosensors for electrochemical detection of infectious pathogens in liquid biopsies: Current trends and challenges.



- Sensors (Switzerland), 17(11).
<https://doi.org/10.3390/s17112533>
- Chen, Y., Qian, C., Liu, C., Shen, H., Wang, Z., Ping, J., Wu, J., & Chen, H. (2020). Nucleic acid amplification free biosensors for pathogen detection. In *Biosensors and Bioelectronics* (Vol. 153). Elsevier Ltd.
<https://doi.org/10.1016/j.bios.2020.112049>
- Cho, I. H., Kim, D. H., & Park, S. (2020). Electrochemical biosensors: Perspective on functional nanomaterials for on-site analysis. *Biomaterials Research*, 24(1), 1–12.
<https://doi.org/10.1186/s40824-019-0181-y>
- Damborský, P., Švitel, J., & Katrlík, J. (2016). Optical biosensors. *Essays in Biochemistry*, 60(1), 91–100. <https://doi.org/10.1042/EBC20150010>
- Kumar, N., & Upadhyay, L. S. B. (2018). Polymeric gels for biosensing applications. In *Polymeric Gels* (pp. 487–503). Elsevier.
<https://doi.org/10.1016/b978-0-08-102179-8.00019-3>
- Kundu, M., Krishnan, P., Kotnala, R. K., & Sumana, G. (2019). Recent developments in biosensors to combat agricultural challenges and their future prospects. *Trends in Food Science and Technology*, 88, 157–178.
<https://doi.org/10.1016/j.tifs.2019.03.024>
- Li, H., Liu, X., Li, L., Mu, X., Genov, R., & Mason, A. J. (2017). CMOS Electrochemical Instrumentation for Biosensor Microsystems: A Review. *Sensors*, 17(74), 1–26.
<https://doi.org/10.3390/s17010074>
- Md Khudzari, J., Kurian, J., Tartakovsky, B., & Raghavan, G. S. V. (2018). Bibliometric analysis of global research trends on microbial fuel cells using Scopus database. *Biochemical Engineering Journal*, 136, 51–60.
<https://doi.org/10.1016/j.bej.2018.05.002>
- Oluwaseun, A. C., Phazang, P., & Sarin, N. B. (2018). Biosensing Technologies for the Detection of Pathogens - A Prospective Way for Rapid Analysis. In *Biosensing Technologies for the Detection of Pathogens - A Prospective Way for Rapid Analysis*. InTech.
<https://doi.org/10.5772/intechopen.74668>
- Panno, S., Matic, S., Tiberini, A., Caruso, A. G., Bella, P., Torta, L., Stassi, R., & Davino, S. (2020). Loop mediated isothermal amplification: Principles and applications in plant virology. *Plants*, 9(4), 1–28. <https://doi.org/10.3390/plants9040461>
- Papadakis, G., Skandalis, N., Dimopoulou, A., Glynos, P., & Gizeli, E. (2015). Bacteria murmur: Application of an acoustic biosensor for plant pathogen detection. *PLoS ONE*, 10(7).
<https://doi.org/10.1371/journal.pone.0132773>
- Scognamiglio, V., Antonacci, A., Arduini, F., Moscone, D., Campos, E. V. R., Fraceto, L. F., & Palleschi, G. (2019). An eco-designed paper-based algal biosensor for nanoformulated herbicide optical detection. *Journal of Hazardous Materials*, 373, 483–492.
<https://doi.org/10.1016/j.jhazmat.2019.03.082>
- Seo, J. S., & Kim, J. (2020). Plant Science Nitrogen molecular sensors and their use for screening mutants involved in nitrogen use efficiency. *Plant Science*, 298(June), 110587.
<https://doi.org/10.1016/j.plantsci.2020.110587>
- Van Eck, N. J., & Waltman, L. (2011). Text mining and visualization using VOSviewer. Centre for Science and Technology Studies, Leiden University, The Netherlands.
www.vosviewer.com.
- Van Eck, N. J., & Waltman, L. (2014). Visualizing Bibliometric Networks. In *Measuring Scholarly Impact* (pp. 285–320). Springer International Publishing. https://doi.org/10.1007/978-3-319-10377-8_13
- Van Eck, N. J., & Waltman L. (2020). User Interface. In *Manual for VOSviewer 1.6.15*.
<https://www.vosviewer.com/getting-started>.



Studies on the Morphological and Mechanical Properties of Oil Palm Empty Fruit Bunch-derived Nanocellulose for Supercapacitor Applications

Kara Danielle T. Co, Jannah Kirstenn R. Go, Jules Asner M. Robins,
and Gregory Charles K. Tiong
De La Salle University Integrated School, Manila

Dr. Maria Carla F. Manzano, *Research Adviser*
De La Salle University, Manila

Abstract: Electricity is an essential resource and aspect of our daily lives. To cope with its high demands, supercapacitors and more efficient batteries have been introduced to the market; the separator is an integral part in the performance of supercapacitors. This study determined the morphology, chemical composition, and mechanical properties of oil palm empty fruit bunch nanocellulose as a separator for supercapacitors and compared its performance with other agricultural materials (e.g. eggshell membrane, cotton textile, and tree leaves) and a membrane electrode assembly. The OPEFB nanocellulose has the morphology and mechanical properties that make it a possible supercapacitor separator material. The porous agglomerate of microfibers and surface nanostructures provide higher effective surface area and may aid in the diffusion of ions. Measured Young's modulus of 6.00 MPa/%, yield strength of 3.20MPa, and tensile strength of 5.30MPa are comparable to separators used in commercial supercapacitors and the reported eggshell membrane separator. This study provides sustainable and "green" alternatives for current commercial supercapacitor separators.

Key Words: nanocellulose, separator, supercapacitor, mechanical strength

1. INTRODUCTION

A supercapacitor is an electrochemical energy storing device used to power technology in various fields ranging from the military to the automotive industry. It has four major components: electrodes, current collectors, electrolytes, and a separator (Nor et al., 2014). The positive and negative electrodes are divided by a non-conductive material called a separator and a small distance to allow for greater storage of electrical energy in a smaller area of space (Dume, 2017).

Separators act as a barrier to prevent short-circuiting by the direct contact of the opposite polarities and to allow the easy flow of electrolytes (He et al., 2017). Present supercapacitor separators use polyolefins for electrochemical stability; however, their low porosity does not meet the high energy needs of the supercapacitor (Du et al., 2017), and the mechanical deformability (Azais et al., 2016) can lead to circuit shortage. Polyolefins are also nonrenewable, unsustainable for mass production, and hold around 20 to 30% of space in landfills (Longo et al., 2011). An example of a polymer-based separator is a Membrane Electrode Assembly (MEA) commonly used in fuel cells (Fuel Cell Store, n.d.). One of the most common membranes in the commercial market is Nafion™, a

perfluorosulfonic acid polymer membrane (Kundu et al., 2005).

Cellulose, and its nanoscale forms, is a natural polymer with innovative applications in materials science (Klemm et al., 2018). Moreover, nanocellulose (NC) has emerged as a promising material for separators. Aside from being sustainable, NC separators have electrochemical and mechanical stability which are essential in a supercapacitor (Guo et al., 2020).

In this study, NC from oil palm empty fruit bunch (OPEFB) was characterized as a separator material for supercapacitor applications. OPEFB is a major waste product of the palm oil industry. As of 2013, the Philippines produces an average of 120,000 tons of oil palm (Philippine Coconut Authority, n.d.). With the rise of agricultural waste, waste management methods have been proposed which include waste recycling and deriving energy from waste (Abdullah & Sulaim, 2013). The OPEFB can be collected during the recycling process of agricultural wastes, and then made into a separator. It has been successfully made as a bioplastic (Iriani et al., 2019) and used as an electrode (Nor et al., 2014). Furthermore, NC has proved to have excellent electrochemical and mechanical properties; its rich carbon content and high porosity ensure outstanding



electrochemical performance (Guo et al., 2020). Separators made from agricultural products can be locally produced, making technology more accessible to developing countries. This study will benefit the fields of materials science and electrochemistry while also encouraging sustainable energy initiatives from the government.

In this study, the morphological, chemical, and mechanical properties of OPEFB NC as a separator were investigated. Specifically, the authors:

characterized the OPEFB nanocellulose in terms of its surface morphology and chemical composition by scanning electron microscopy and energy dispersive spectroscopy and mechanical properties, i.e. mechanical strength, and stiffness, by a comprehensive materials testing system;

measured the stiffness of the separator material through Young's modulus, its yield strength, and tensile strength; and

compared the morphological and mechanical properties of OPEFB nanocellulose with that of MEA 144A and other separator materials made from agricultural wastes reported from previous studies.

2. Cellulose-based Materials for Supercapacitors

2.1 Oil Palm Empty Fruit Bunch (OPEFB)

OPEFB is a byproduct of palm oil production (Han and Kim, 2018) composed of cellulose, hemicellulose, and lignin (Rosli et al., 2017). It contains around 40-44% of cellulose (Foo et al., 2020), so it may be deemed a potential source of NC (Septevani et al., 2020). Aside from its content being notable, it has high availability due to its abundance in Southeast Asian countries. OPEFB also accounts for 1/3 of oil palm biomass (Geng, 2013). Thus, it is a reliable and sustainable source of NC for supercapacitor applications.

In the study of Teow et al. (2020), the OPEFB diameter decreased from $228.88 \pm 6.63 \mu\text{m}$ to $13.63 \pm 3.10 \mu\text{m}$ after cellulose extraction as seen in the scanning electron microscope (SEM) analysis displayed in Figure 1. It can be inferred that it is possible to use cellulose as a separator as its size can be reduced to fit the supercapacitor.

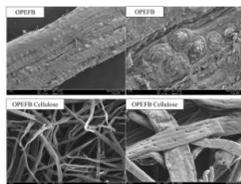

Figure 1. SEM micrographs of the OPEFB and cellulose extracted from the OPEFB under different magnification: (a) $250\times$ (scale bar $20 \mu\text{m}$) and (b) $1.00k$ (scale bar $10 \mu\text{m}$) (Teow et al., 2020)

Previous works have applied OPEFB in supercapacitor electrodes (Ishak et al, 2015; Dolah et al, 2014; Farma et al., 2013); however, no study has used it as a separator.

2.2 Mechanical Properties of Previous Studies

Mechanical properties play a big role in characterizing the quality of cellulose material. Through these, the performance of a separator may be expected. Given the position of a separator, it needs to have minimal resistance from the movement of electrolyte ions (Yu et al., 2012). Properties that could predict the performance of the separator include surface morphology, mechanical strength, and stiffness. The surface morphology of a material can be utilized to characterize the porosity and material structure (Adeleke et al., 2019). The mechanical strength and stiffness of a separator also play a crucial part in characterizing the possible life span of the supercapacitor and other energy storage devices. The study conducted by Mandake and Karandikar (2016) showed that thicker separators would correspond to lower porosity. Considering that high porosity is needed in a separator, it should be thin enough for high porosity while maintaining a good mechanical strength and stiffness. In the studies of Gao (2015) on cotton textile as a separator, Yu et al. (2012) on eggshell membrane as a separator, and Jin et al. (2019) on tree leaves as a separator, the results showed excellent mechanical strength and properties alongside high porosity and superb electrochemical properties.

A source that has been used as a separator material is eggshell membrane (ESM) (Yu et al., 2012). It has high mechanical strength, with reported maximum stress and maximum strain values of $\sigma_{\text{max}} = 6.59 \pm 0.48 \text{ MPa}$ and $\epsilon_{\text{max}} = 6.98 \pm 0.31\%$, respectively. Figure 2 displays the surface morphology of the eggshell membrane showing shell membrane fibers of thickness 0.5 to $1 \mu\text{m}$, and pore sizes of 1 to $3 \mu\text{m}$.

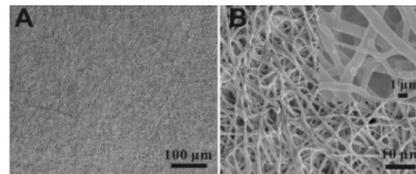

Figure 2. SEM photographs of ESM at low (A) and high (B) magnifications (Yu et al., 2012)

The cotton textile was also reported to show ideal surface morphology as a separator material. The nanostructure and nanowires found on the surface of the material (Figure 3) were found to have minimum

dimensions of 5µm and 20µm, respectively (Gao, 2015).

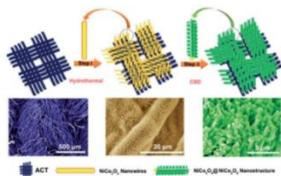

Figure 3. Illustration of the nanostructures of NiCo₂O₄@NiCo₂O₄ covering activated carbon textiles (ACTs) (Gao, 2015)

The application of four different tree leaves to create a separator for a graphene-based supercapacitor was investigated by Jin et al. (2019). These four tree leaves are cinnamomum camphora (CC), magnolia grandiflora (MG), platanus orientalis (PO) and osmanthus fragrans (OF). The separator made from activated CC showed most promising results. Figure 4 shows the surface morphology of the 4 leaves at a bar of 10 µm. The mechanical properties of the separator materials based on agricultural sources discussed are summarized in Table 1.

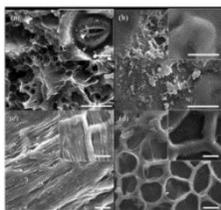

Figure 4. SEM images of the 4 different activated tree leaves: (a) CC; (b) MG; (c) PO; (d) OF. All bars are at 10 µm. (Jin et al., 2019)

Table 1. Comparative Summary of Mechanical Properties of Separators Based on Agricultural Sources

Paper Title and Author	Agricultural Source	Mechanical Properties		
		Surface Morphology	Mechanical Strength	Stiffness
Using eggshell membrane as a separator in supercapacitor (Yu et al., 2012)	Eggshell membrane	0.5 to 1 µm (shell membrane fibers) and 1-3 µm (macropores)	$\sigma_{max} = 5.59 \pm 0.48$ MPa (maximum stress) and $\epsilon_{max} = 6.98 \pm 0.31\%$ (maximum strain)	xxx
Cotton textile enabled, all-solid-state flexible supercapacitors (Gao, 2015)	Cotton Textile	5 µm (nanostructure) and 20 µm (nanowires)	xxx	xxx
Tree leaves-derived three-dimensional porous networks as separators for graphene-based supercapacitors (Jin et al., 2019)	Tree Leaves	10 µm	xxx	xxx

2. METHODOLOGY

The separator material used in this study is an oil palm empty fruit bunch nanocellulose (OPEFB

NC) film. The OPEFB NC material was characterized to determine its morphological and mechanical properties, as well as chemical composition. A comparative study was done with other agricultural-product based NC separator materials from previous studies and the OPEFB NC investigated in this work on the basis of mechanical strength and surface morphology.

2.1. Research Design

The quantitative characterization techniques used in studying the properties of OPEFB NC are scanning electron microscopy, energy dispersive spectroscopy, and stress-strain test. The surface morphology of the OPEFB NC was measured using a JEOL JSM 5310 scanning electron microscope (SEM). Elemental analysis was done using the EDAX energy dispersive spectroscopy (EDS) system attachment of the JEOL JSM 5310 SEM to determine the elemental composition of the sample (Intertek, n.d.). Furthermore, a PASCO Comprehensive Materials Testing System ME-8244, an equipment used for tensile testing (PASCO, n.d.), was utilized to obtain the stress vs. strain and force vs. position graphs for the OPEFB NC sample. From the stress-strain plot, the mechanical properties, specifically the Young's modulus, yield strength, and tensile strength of the sample were determined. The measured morphology and mechanical properties of the OPEFB NC separator material were then compared with those of eggshell membrane, cotton textile, and tree leaves.

2.2. Data Analysis

For most metals and plastics polymers, stress σ (in Pa) and strain ϵ are directly proportional to each other, i.e. $\sigma = E\epsilon$, wherein E is Young's modulus (in Pa) or the modulus of elasticity. In this study, the measure of stiffness of the sample, i.e. Young's modulus, was determined from the slope of the linear portion of the stress-strain curve. As the stress on the sample was increased during testing, the sample experiences a gradual elastic-plastic transition. The yield strength (in Pa) was determined at the point on the stress-strain curve when the curve starts to depart from linearity; this is the amount of stress that the sample can take without undergoing plastic deformation. After passing the yield point, the stress needed to continue the plastic deformation of the sample increases and then reaches a maximum point. The tensile strength (in Pa) is simply the stress at the maximum point of the stress-strain curve. This is the maximum stress the sample can sustain when in tension.

3. RESULTS AND DISCUSSION

The SEM images of the OPEFB NC in Figure 5 show the surface morphology at x10000, x1000, and x500 magnification, respectively. The microfibers of cellulose (~2 to 6 μm) are a disordered agglomeration interspersed with nanoparticles, which are possibly silica on fiber surface, consistent with the report of Mohammad et al. on thermally pre-treated OPEFB used for biofuel production (2020). The presence of silica in supercapacitor electrode or separator materials was shown to exhibit excellent stability and flexibility (Pérez-Madrigal et al., 2016). The size of the microfibers in the OPEFB are comparable to those found in eggshell membranes and cotton textile. The nanoparticles and interwoven microfibers on the surface of the OPEFB sample indicate larger effective surface area, which may aid in better diffusion of ions and in turn good electrochemical performance. The OPEFB surface morphology is smoother compared to that of the eggshell membrane fibers, cotton textile, and tree leaves. This is ideal for a supercapacitor

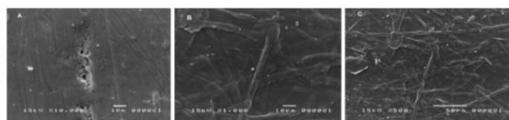

Figure 5. SEM images of the OPEFB at (A) x10000, (B) x1000, and (C) x500 magnifications, respectively

separator material as it allows good contact between the electrodes; however, the OPEFB sample's lower porosity as compared to the other three materials may reduce the ion mobility.

The results of the elemental analysis of the OPEFB sample obtained from EDS are shown in Figure 6. The EDS spectra shows that the sample consisted of C (41.26 wt%), O (51.59 wt%), Al (0.58 wt%), Si (0.56 wt%), S (5.44 wt%) and Cu (0.57 wt%).

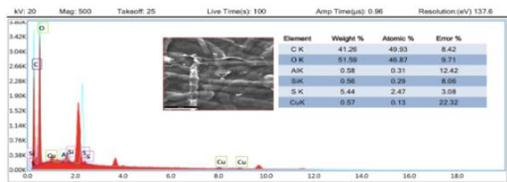

Figure 6. EDS elemental analysis of OPEFB sample

The mechanical properties of the OPEFB sample were determined from the plot of the stress-strain data as depicted in Figure 7. On the stress-strain curve, the linear portion of the elastic region is until the applied stress rose to 3.20MPa. Calculating the slope of this linear portion resulted in a Young's modulus of 6.00MPa. At a stress level of 3.20 MPa

(yield strength), the curve starts to depart from

Table 2. Comparison of Mechanical Properties of OPEFB NC, eggshell membrane, and MEA 144A

Paper Title and Author	Material	Young's Modulus (MPa/%)	Yield Strength (MPa)	Tensile Strength (MPa)	Maximum Strain (%)
Authors' Paper	OPEFB NC	6.00	3.20	5.30	3.45
Using eggshell membrane as a separator in supercapacitor (Yu et al., 2012)	Eggshell Membrane	xxx	xxx	6.59	6.98
Mechanical Properties of Nafion™ electrolyte membranes under hydrated conditions (Kundu et al., 2005)	MEA 144A	3.23	2.19	xxx	xxx

linearity. This is the point when yielding occurs and plastic deformation of the sample begins. As further stress was applied to the sample, it then fractured when the applied stress reached 5.30 MPa (tensile strength).

The tensile strength of the OPEFB NC is slightly lower than that of the eggshell membrane separator material (Table 2). However, compared to the MEA 144A separator used in commercial supercapacitors, the Young's modulus of OPEFB NC is almost twice. This implies that OPEFB NC separator has sufficient strength to prevent contact between electrodes and will be able to maintain integrity during manufacturing and transport. This structural integrity in OPEFB NC is also necessary as separators swell and deform during the charge-discharge process.

4. CONCLUSIONS

The OPEFB NC separator has the morphology and mechanical properties that make it a possible supercapacitor separator material. The porous agglomerate of microfibers and surface nanostructures provide higher effective surface area and may aid in the diffusion of ions. Measured Young's modulus of 6.00 MPa/%, yield strength of 3.20MPa, and tensile strength of 5.30MPa are comparable to separators used in commercial supercapacitors and reported separator material from eggshell membrane. For future studies, the electrochemical properties should also be investigated to further assess its suitability as a supercapacitor separator.

5. ACKNOWLEDGMENTS

This paper was made possible through the efforts of the research proponents, the research



advisor Dr. Carla Manzano, the DLSU Physics Department Solid State Physics Research Group, Dr. Hui Lin Ong for providing the OPEFB NC, and Dr. Norberto Alcantara, Mr. Reynaldo Coria, Mr. Julius Lopez, and Mr. Hector Padrido for assisting in the characterization.

6. REFERENCES

- Abdullah, N., & Sulaim, F. (2013). The oil palm wastes in Malaysia. *Biomass Now - Sustainable Growth and Use*. <https://doi.org/10.5772/55302>
- Adeleke, O. A., Latiff, A. A., Saphira, M. R., Daud, Z., Ismail, N., Ahsan, A., Aziz, N. A. A., Mohammed, N., Kumar, V., Adel, A., Rosli, M. A., Hijab, M. (2019). Locally derived activated carbon from domestic, agricultural and industrial wastes for the treatment of palm oil mill effluent. *Nanotechnology in Water and Wastewater Treatment*, 35-62. <https://doi.org/10.1016/b978-0-12-813902-8.00002-2>
- Azais, P., Tamic, L., Huitric, A., Paulais, F. and Rohel, X. (2016). Separator film, its fabrication method, supercapacitor, battery and capacitor provided with said film, US. Pat. 9,461,288. <https://patents.google.com/patent/US9461288B2/en>
- Dolah, B. N. M., Deraman, M., Othman, M. A. R., Farma, R., Taer, E., Basri, N. H., Talib, I. A., Omar, R., & Nor, N. S. M. (2014). A method to produce binderless supercapacitor electrode monoliths from biomass carbon and carbon nanotubes. *Materials Research Bulletin*, 60, 10-19. <https://doi.org/10.1016/j.materresbull.2014.08.013>
- Du, X., Zhang, Z., Liu, W., & Deng, Y. (2017). Nanocellulose-based conductive materials and their emerging applications in energy devices-A review. *Nano Energy*, 35, 299-320. <https://doi.org/10.1016/j.nanoen.2017.04.001>
- Dume, I. (2017). Graphene supercapacitor breaks storage record. <https://physicsworld.com/a/graphene-supercapacitor-breaks-storage-record/>
- Farma, R., Deraman, M., Awitdrus, A., Talib, I. A., Taer, E., Basri, N. H., Manjunatha, J. G., Ishak, M. M. Mollah, B. N. M., & Hashmi, S. A. (2013). Preparation of highly porous binderless activated carbon electrodes from fibres of oil palm empty fruit bunches for application in supercapacitors. *Bioresource technology*, 132, 254-261. <https://doi.org/10.1016/j.biortech.2013.01.044>
- Foo, M. L., Ooi, C. W., Tan, K. W., & Chew, I. M. L. (2020). A step closer to sustainable industrial production: Tailor the properties of nanocrystalline cellulose from oil palm empty fruit bunch. *Journal of Environmental Chemical Engineering*, 104058. <https://doi.org/10.1016/j.jece.2020.104058>
- Fuel Cell Store. (n.d.). Membrane electrode Assemblies (MEA). <https://www.fuelcellstore.com/fuel-cell-components/membrane-electrode-assembly>
- Gao, Z., Song, N., Zhang, Y., & Li, X. (2015). Cotton textile enabled, all-solid-state flexible supercapacitors. *RSC advances*, 5(20), 15438-15447. <https://doi.org/10.1039/C5RA00028A>
- Geng, A. (2013). Conversion of oil palm empty fruit bunch to biofuels. Liquid, gaseous and solid biofuels. London: InTech Open Access Publisher, 479-90. <https://doi.org/10.5772/53043>
- Guo, R., Zhang, L., Lu, Y., Zhang, X., & Yang, D. (2020). Research progress of nanocellulose for electrochemical energy storage: A review. *Journal of Energy Chemistry*. <https://doi.org/10.1016/j.jechem.2020.04.029h>
- Han, J., & Kim, J. (2018). Process simulation and optimization of 10-MW EFB power plant. *Computer Aided Chemical Engineering*, 43, 723-729. <https://doi.org/10.1016/B978-0-444-64235-6.50128-5>
- He, T., Jia, R., Lang, X., Wu, X., & Wang, Y. (2017). Preparation and electrochemical performance of PVdF ultrafine porous fiber separator-cum-electrolyte for supercapacitor. *Journal of The Electrochemical Society*, 164(13), E379. <https://iopscience.iop.org/article/10.1149/2.0631713jes/meta>
- Intertek. (n.d.). Energy dispersive x-ray analysis (EDX). <https://www.intertek.com/analysis/microscopy/edx/>
- Iriani, E. S., Permana, A. W., Yuliani, S., Kailaku, S. I., & Sulaiman, A. A. (2019). The effect of agricultural waste nanocellulose on the properties of bioplastic for fresh fruit packaging. *IOP Conference Series: Earth and Environmental*



- Science, 309, 012035.
<https://doi.org/10.1088/1755-1315/309/1/012035>
- Ishak, M. M., Deraman, M., Talib, I. A., Basri, N. H., Awitdrus, Farma, R., Taer, E., Omar, R., Nor, N. S. M., & Dolah, B. N. M. (2015). Effect of carbonization temperature on the physical and electrochemical properties of supercapacitor electrode from fibers of oil palm empty fruit bunches. *AIP Conference Proceedings*, 1656(1), 030005. <https://doi.org/10.1063/1.4917094>
- Jin, L., Wei, K., Xia, Y., Liu, B., Zhang, K., Gao, H., Chu, X., Ye, M., He, L., Lin, P. (2019). Tree leaves-derived three-dimensional porous networks as separators for graphene-based supercapacitors. *Materials Today Energy*, 14, 100348. <https://doi.org/10.1016/j.mtener.2019.100348>
- Klemm, D., Cranston, E. D., Fischer, D., Gama, M., Kedzior, S. A., Kralisch, D., Kramer, F., Kondo, T., Lindstrom, T., Nietzsche, S., Petzold-Welcke, K., & Rauchfuß, F. (2018). Nanocellulose as a natural source for groundbreaking applications in materials science: Today's state. *Materials Today*, 21(7), 720-748. <https://doi.org/10.1016/j.mattod.2018.02.001>
- Kundu, S., Simon, L. C., Fowler, M., & Grot, S. (2005). Mechanical properties of Nafion™ electrolyte membranes under hydrated conditions. *Polymer*, 46(25), 11707-11715. <https://doi.org/10.1016/j.polymer.2005.09.059>
- Longo, C., Savaris, M., Zeni, M., Brandalise, R. N., & Grisa, A. M. C. (2011). Degradation study of polypropylene (PP) and bioriented polypropylene (BOPP) in the environment. *Materials Research*, 14(4), 442-448. <http://dx.doi.org/10.1590/S1516-14392011005000080>
- Mandake, P., & Karandikar, D. (2016). Significance of separator thickness for supercapacitor. *International Journal for Research in Applied Science & Engineering Technology (IJRASET)*, 4(2), 214-218. <https://www.ijraset.com/files/serve.php?FID=3910>
- Mohammad, I. N., Ongkudon, C. M., & Misson, M. (2020). Physicochemical properties and lignin degradation of thermal-pretreated oil palm empty fruit bunch. *Energies*, 13(22), 5966. <https://doi.org/10.3390/en13225966>
- Nor, N. S. M., Deraman, M., Omar, R., Taer, E., Awitdrus, Farma, R., Basri, N. H., & Dolah, B. N. M. (2014). Nanoporous separators for supercapacitor using activated carbon monolith electrode from oil palm empty fruit bunches. *AIP Conference Proceedings*, 1586(1), 68-73. <https://doi.org/10.1063/1.4866732>
- PASCO. (n.d.). Comprehensive materials testing system ME-8244. <https://www.pasco.com/products/lab-apparatus/mechanics/materials-testing/me-8244>
- Pérez-Madrigal, M. M., Edo, M. G., & Alemán, C. (2016). Powering the future: Application of cellulose-based materials for supercapacitors. *Green Chemistry*, 18(22), 5930-5956. <https://doi.org/10.1039/c6gc02086k>
- Philippine Coconut Authority. (n.d.). Philippine Palm Oil Industry Roadmap. <https://pca.gov.ph/images/brochure/oilPalms.pdf>
- Rosli, N. S., Harun, S., Jahim, J. M., & Othaman, R. (2017). Chemical and physical characterization of oil palm empty fruit bunch. *Malaysian Journal of Analytical Sciences*, 21(1), 188-196. <http://dx.doi.org/10.17576/mjas-2017-2101-22>
- Septevani, A. A., Rifathin, A., Sari, A. A., Sampora, Y., Ariani, G. N., Sudiarmanto, & Sondari, D. (2020). Oil palm empty fruit bunch-based nanocellulose as a super-adsorbent for water remediation. *Carbohydrate Polymers*, 229, 115433. <https://doi.org/10.1016/j.carbpol.2019.115433>
- Teow, Y. H., Amirudin, S. N., & Ho, K. C. (2020). Sustainable approach to the synthesis of cellulose membrane from oil palm empty fruit bunch for dye wastewater treatment. *Journal of Water Process Engineering*, 34, 101182. <https://doi.org/10.1016/j.jwpe.2020.101182>
- Yu, H., Tang, Q., Wgu, J., Lin, Y., Fan, L., Huang, M., Lin, J., Yan, L., & Yu, F. (2012). Using eggshell membrane as a separator in supercapacitor. *Journal of Power Sources*, 206, 463-468. <https://doi.org/10.1016/j.jpowsour.2012.01.116>



The Potential Electrospinnability and Filtration Capabilities of Pea-Protein Isolate/Polyvinyl Alcohol Air Filter Nanofabrics: A Systematic Review

Eryn Sophia B. Amante, Christian L. Angeles, Enrique Rafael A. Lejano,
and Cheska Marie F. Rosal

De La Salle University Integrated School, Biñan City, Laguna

Abstract: Given the pervasiveness of air pollution with varying components and the shortcomings of conventional air filter mats, multifunctional air filters are becoming increasingly important. This has led to the development of air filter nanofabrics comprising bio-based components (such as chitin and proteins) and polymers (such as polyvinyl alcohol and pullulan). Electrospun air filter nanofabrics containing pea protein isolate (PPI) and polyvinyl alcohol (PVA) have yet to be developed to the researchers' knowledge. In this study, the potential electrospinnability and filtration capabilities of PPI and PVA were assessed and elaborated via a systematic review. Since PPI's globular morphology lacks molecular entanglement, PVA, an auxiliary spinning polymer with protein binding capabilities, is needed to aid PPI. Combining the two has successfully produced electrospun homogenous nanofabrics. Additionally, the nanofabrics likely possess physical and chemical filtration capabilities due to desirable material properties and powerful intermolecular interactions. Thus, PPI/PVA nanofabrics show great potential for multifunctional air filtration applications.

Key Words: air filter; nanofabric; pea protein isolate; polyvinyl alcohol; electrospinnability

1. INTRODUCTION

Clean air is crucial to maintaining good health. According to WHO (2019), nine out of ten people inhale toxic air—often leading to strokes, chronic respiratory diseases, and lung cancer. While traditional air filter mats can effectively filter larger particulate matter (PM) through size-based mechanisms, polluted air also contains toxic chemicals (like nitrogen dioxide, methane, and formaldehyde), viruses, and bacteria not easily captured by these filters. Furthermore, conventional filters often comprise chemically synthesized materials—such as polyethylene and polypropylene—producing secondary pollution when disposed of (Souzandeh et al., 2016). Therefore, multifunctional and eco-friendly air filters are needed to fill this significant gap in air filtration technology.

Souzandeh et al. (2016) helped fill this gap by developing multifunctional soy protein isolate/polyvinyl alcohol (SPI/PVA) air filter nanofabrics. Protein isolates are highly concentrated protein fractions produced for their prominent nutritional and functional properties (Sandberg, 2011). Polyvinyl alcohol (PVA) is a water-soluble polymer synthesized by hydrolyzing polyvinyl acetate in ethanol with potassium hydroxide. It has several applications due to its cohesiveness, film toughness,

and biocompatibility (Wu et al., 2019). The nanofabrics were developed by electrospinning, which is among the simplest and most effective methods for creating nanofabrics. It is a voltage-driven process governed by the electrohydrodynamic phenomena where fibers and particles are made from a polymer solution (Nanoscience Instruments, 2019). The nanofabrics' efficient particulate and chemical removal efficiency and overall eco-friendliness due to their biodegradable components make them highly desirable. Since bio-based nanofabrics can potentially revolutionize air filtration technology, expanding upon relatively little existing knowledge is imperative. Thus, alternative protein isolate components should be explored.

Pea exhibits similar properties with soy, given they are both members of the legume family. Since pea protein shares the globular nature of soy protein, an auxiliary spinning polymer such as PVA must be employed to enhance the nanofabric morphology. Therefore, this study aims to expand upon existing knowledge by assessing the feasibility of integrating pea protein isolate (PPI) and PVA to be electrospun into nanofabrics by conducting a systematic review.

A systematic review is an assessment of information and evidence for pre-defined questions using systematic methods of searching, selecting, and evaluating relevant primary studies and thorough extraction, analysis, and synthesis of the studies



included in the review (Wright et al., 2007). By utilizing the systematic review process, the study seeks to answer two main questions:

Are PPI, PVA, and a solution of the two compatible with electrospinning?

Would a nanofabric comprising PPI and PVA exhibit multifunctional filtration capabilities?

2. METHODOLOGY

2.1. Study Design

The systematic review structure was adapted from the Cochrane Handbook For Systematic Reviews of Interventions and The Preferred Reporting Items for Systematic Reviews and Meta-Analyses (PRISMA) to formulate a suitable systematic review design. The Cochrane Handbook is a guide that meticulously explains all the necessary steps in preparing for and executing a Cochrane systematic review. This type of literature review produces high-quality evidence and great credibility due to its strict, predefined methods of data collection and risk assessment (Handoll et al., 2008). PRISMA served as a guide for summarizing and reporting the study selection and screening process.

The Cochrane Risk of Bias Tool formed the basis for the Risk of Bias Assessment phase. This phase improves the study's transparency by potentially spotting flaws or biases within each selected article's methodology and reporting of results. Thus, the researchers assessed each of the final articles for possible bias through four of the six Cochrane bias domains. Each domain was given a rating of high risk, low risk, or unclear risk of bias based on signaling questions.

2.1. Search Strategy

The researchers conducted a comprehensive literature search using the databases and keywords listed in Tables 1 and 2.

Table 1. List of databases used

Databases
Elsevier
ScienceDirect
Researchgate
PubMed Central
SciFinder
Scopus
Taylor & Francis Online

Table 2. Summary of search strategy and keywords utilized

Search Strategy	Keywords used
Identification of similar literature related to the proposed topic	"pea protein isolate", "soy protein isolate", "soy protein", "pea protein", "legumes"
Identification of studies integrating pea protein isolate and polyvinyl alcohol	"pea protein", "pea protein isolate", "polyvinyl alcohol", "integration"
Efficacy of pea protein isolate and polyvinyl alcohol nano fabric as a potential multi-functional air filter	"pea protein", "pea protein isolate", "nano fabric", "air filters", "polyvinyl alcohol", "multi-functional air filter", "potential", "chemical and physical filtration"
Integration of the electrospinning process	"morphology", "molecular entanglement", "pea protein electro spin ability", "polyvinyl alcohol electro spin ability", "nano fabric"

The inclusion and exclusion criteria set boundaries and confinements for the study. Since pea protein isolate (PPI) and polyvinyl alcohol (PVA) have been included in various studies, the researchers found it suitable to set criteria for their research.

Table 3. Inclusion and Exclusion Criteria

Inclusion Criteria	Exclusion Criteria
Studies concerning PPI and/or PVA in electrospinning applications	Studies concerning the feasibility of the PPI-PVA nanofabric being integrated with other working air filter designs
Studies concerning the viscosity, electrical conductivity and/or morphology of PVA and/or PPI nanofibers	Studies not written in the English language
Studies concerning the capability of PVA and PPI to capture particles	
Studies concerning the physical or chemical properties of PPI and PVA	
Studies concerning the functional groups and amino acids of PVA and PPI	

2.3. Study Selection

For organized documentation, the PRISMA statement flow diagram was utilized (Figure 1).

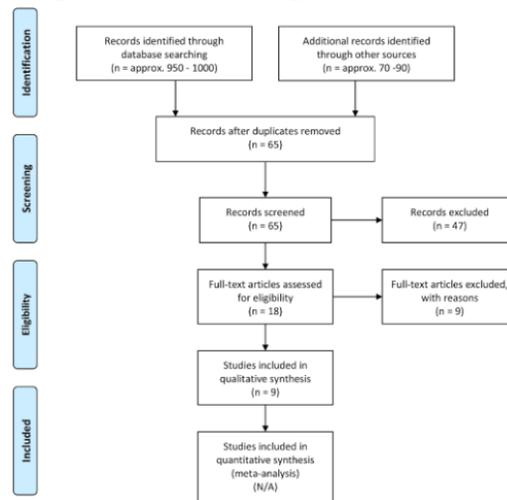



Sixty-five articles were selected through their titles. After collecting and organizing the articles, a color-coding method was used to decide whether the article was usable (green), usable but needs further reading (purple), or unusable (red). After the initial screening, the researchers conducted a full-text assessment of eligibility for systematic review, wherein the researchers used the color-coded method to decide if the article's information would be the key for answering research questions included in the review (green), helpful information to supplement the review (blue), or information deemed unhelpful for the review (red). Subsequently, eligible articles were assessed and categorized into research objectives one or two.

2.2 Risk Assessment of Bias

Each selected article was given a color-coded assessment for bias using the following colors: Green (Low Risk), Yellow (Uncertain), and Red (High Risk). From Figure 2, the "majority" method was utilized to classify whether an article is a high risk or low risk. The assessment showed 88.8% of the final articles had a low risk. This means that most of the studies are not prone to different biases.

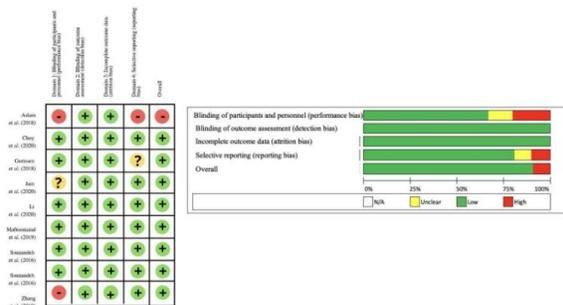

Figure 2. Summary of Risk of Bias Assessment (Tabular and Graph)

3. RESULTS AND DISCUSSION

3.1 Compatibility of PPI, PVA, and a solution of two with electrospinning

Creating bio-based PPI/PVA nano fabrics begins with electrospinning; therefore, the electrospinnability of these components is crucial for successful fiber formation. PPI's globular nature and lack of molecular entanglement hampers its electrospinnability. Therefore, an auxiliary polymer is vital to improving PPI's electrospinnability. PVA, a proven spinnable polymer, complements PPI in electrospinning due to its biodegradability, non-toxicity, biocompatibility, and protein binding capabilities through hydrogen bonding (Li et al., 2020). The two notable parameters that must be considered when electrospinning PVA are alcoholysis

degree and solution viscosity (Table 4.a). An alcoholysis degree of 87-89% and a relatively lower solution viscosity are recommended for optimal nano fabrics. Moreover, several studies provide supporting evidence on the electrospinnability of PPI and PVA, both with other components and with each other. Although, the following parameters must be considered: viscosity, the pH level of concentration, the ratio of PPI to PVA, electrical conductivity, and distance from tip to the collector, each of which is elaborated in Table 4.b. It is evident that PPI and PVA could be electrospun as long as similar parameters are followed.

Table 4.a. Factors affecting electrospinnability of PVA and its corresponding effects

Factors Affecting Electrospinnability of PVA	Effects/ Results of Nanofabrics
Alcoholysis Degree	<ul style="list-style-type: none"> Higher alcoholysis degree (~98-99%) makes nanofabrics too water resistant. Slightly lower alcoholysis degree (~87-89%) produces optimal nanofabrics
Solution Viscosity	<ul style="list-style-type: none"> Relatively lower solution viscosity would produce better electrospun nanofabrics. If the PVA solution is too viscous, when the solvent volatilizes, the polymer chains in the solution entangle and are unable to produce the appropriate fiber-like structure needed for air filtration.

Table 4.b. PPI/PVA electrospinning parameters with corresponding fiber formation effects

Parameters for Electrospinning PVA and PPI	Effects/Results on Fiber Formation
PPI/PVA Solution Concentration	<ul style="list-style-type: none"> > 20:80, 30:70, 50:50, and 40:60 PPI/PVA concentrations formed homogenous nanofabrics > SPI/PVA ratio of 50:50 worked best
PPI/PVA Solution pH Level	<ul style="list-style-type: none"> > pH 12 → gel-like consistency > pH 2 and 7 → bead formation > pH9 → most homogenous
PPI/PVA Solution Viscosity	<ul style="list-style-type: none"> > Lower viscosity is more efficient, as a decreasing apparent viscosity creates more homogenous nanofibers > Extremely low or extremely high viscosity values are not recommended. > Viscosity could only be increased through the range of 0.120 and 0.253 Pa·s.
PPI/PVA Solution Electrical Conductivity	<ul style="list-style-type: none"> > Solutions with electrical conductivity below a critical value would fail. > A flow rate of 1 ml/h and voltage of 15 kV was used to form nanofibers.
Electrospinning Distance from Tip to Collector	<ul style="list-style-type: none"> > Shorter distance = less homogenous fibers with beads > Longer Distance = thinner beads > A 15 cm distance from tip to collector worked for PPI/PVA solution.

Generally, a 50:50 PPI:PVA ratio concentration is found to form fibers successfully. As seen from Figure 3, the fibers formed from the concentrations: 20/80, 30/70, 50/50, and 40/60 were more homogeneous (fewer beads) than other concentrations.

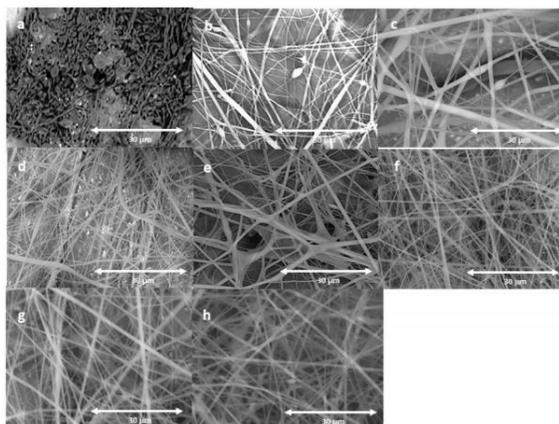

Figure 3. SEM images of PPI/PVA nanofibers at different ratios: a.) 80:20, b.) 70:30 c.) 60:40, d.) 50:50 e.) 40:60 f.) 30:70, g.) 20:80 and h.) 5% PVA from Maftoonazad et al. (2019)

As for the pH level of the solution, Figure 4 shows that a basic solution (pH 9) provides more fiber-like results with no bead formation.

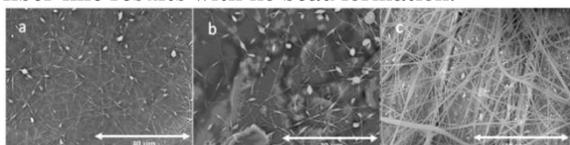

Figure 4. SEM images of PPI/PVA (50:50) Concentration at pH levels 2, 7, and 9 (from left to right) from Souzandeh et al. (2016)

Meanwhile, the solution viscosity and electrical conductivity are summarized in Table 5, where a viscosity range of 0.120 and 0.253 Pa·s and a low electrical conductivity form nanofibers. The parameters allow pea protein isolate and polyvinyl alcohol to be electrospun; therefore, homogenous fibers could be created.

Table 5. Influence of concentration on characteristics of PPI/PVA solution and mat from Maftoonazad et al. (2019)

PPI:PVA Ratio	K (Pa·s) ^a	Electrical Conductivity (S/m)	Apparent Viscosity at 50s ⁻¹	Nanofiber diameter (nm)	Nanofiber morphology
80:20	5.57 ± 0.74 ^a	0.0809 ± 0.0075 ^a	0.330 ± 0.026 ^a	-	No fibers/bead formation
70:30	4.92 ± 0.44 ^{ab}	0.0781 ± 0.0045 ^b	0.301 ± 0.0031 ^a	567 ± 94.1	Nanofiber/bead formation
60:40	2.34 ± 0.14 ^c	0.0816 ± 0.0039 ^b	0.0179 ± 0.0019 ^b	542 ± 110	Nanofibers with some beads
50:50	1.08 ± 0.09 ^d	0.0898 ± 0.0025 ^c	0.0120 ± 0.0011 ^b	498 ± 85.0	Nanofiber
40:60	0.235 ± 0.04 ^e	0.0905 ± 0.0042 ^c	0.0138 ± 0.0032 ^b	492 ± 41.2	Nanofiber
30:70	0.317 ± 0.09 ^e	0.0873 ± 0.0015 ^d	0.0240 ± 0.0043 ^b	474 ± 42.8	Nanofiber
20:80	0.280 ± 0.04 ^e	0.0854 ± 0.0069 ^d	0.0253 ± 0.0019 ^b	448 ± 61.5	Nanofiber

3.2. Multifunctional filtration capabilities of nanofabric comprising PPI and PVA

3.2.1 Physical Filtration Capabilities

Specific material properties of PPI/PVA nanofabrics are the primary parameters that would influence its physical filtration capabilities through size-based mechanisms. Nanofiber diameter affects the capturing of larger particles, as the sieving mechanism entails trapping large particles in between fiber pores. Areal density affects the capturing of smaller particles (micrometer to nanometer range). It controls the contact possibilities between these particles and the nanofibers, thereby influencing the inertial impact, interception, and diffusion mechanisms (Souzandeh et al., 2016). Thermal stability is necessary to avoid nanofiber deformation and fracturing when filtering high-temperature pollutants (Król-Morkisz and Pielichowska, 2019).

Protein/PVA nanofabrics are extremely capable of filtering PM_{10-2.5} (Table 6). These filtration efficiencies are attributed to fiber diameter and the nanofiber pores being smaller than the particles. For example, the SPI/PVA nanofabric maintained near 100% filtration efficiency with its pore size of 4.4 μm. Given that 10 μm is equivalent to 10,000 nm, the fiber diameter and pores are generally smaller than particulate matter (PM). Consequently, capturing efficiency is indirectly related to the fiber diameter. Though the PPI/PVA nanofabric's air filtration efficiency was not tested, its diameter of ~495 nm falls within the range that has successfully captured particles through sieving. Therefore, PPI/PVA nanofabrics show great potential for physical filtration, although the ideal fiber diameter has yet to be defined.

Table 6. PM_{10-2.5} filtration efficiencies and average fiber diameters of protein/PVA nanofabrics

Type of electrospun nanofabric	Filtration efficiency for PM _{10-2.5}	Average fiber diameter
SPI/PVA	99.90% - 99.99%	100 - 200 nm
Zein/PVA	99.99%	60 - 600 nm
Gelatin/PVA	99.63 ± 0.11 %	100 - 600 nm

Figure 5 displays the importance of areal density in filtering PM smaller than 1 μm. Increasing the areal density improved the capturing of 0.3 μm particles, which are among the most challenging sizes to capture. However, there is a point where increasing areal density stops improving filtration efficiency. Therefore, finding an appropriate combination of fiber diameter and areal density is crucial to filtering larger and smaller particles.

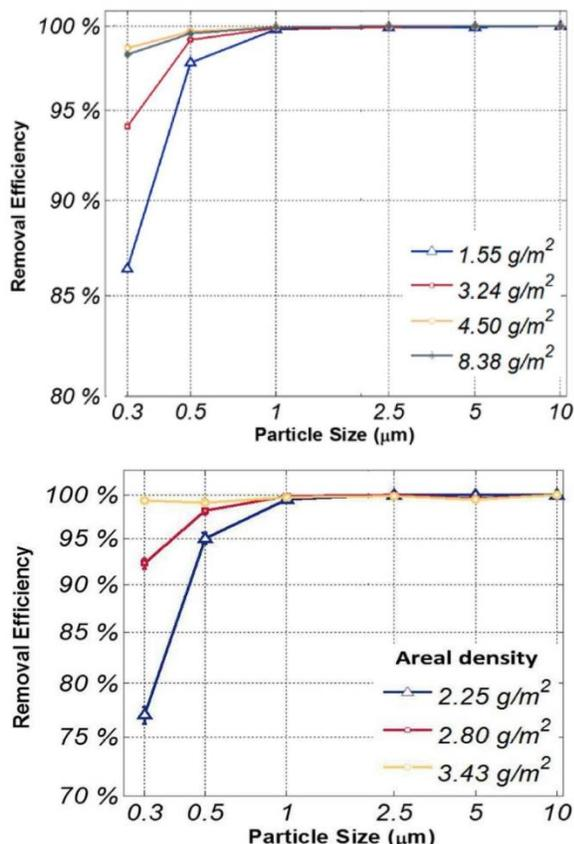

Figure 5. PM removal efficiencies of SPI/PVA (left) and gelatin/PVA (right) nanofabrics with varying areal densities for different particle sizes from Souzandeh et al. (2016)

Nanofabrics utilizing PPI/PVA have good melting points—an indicator of thermal stability. Their thermal stability is ascribed to fiber uniformity and hydrogen bonding between solution components. Polymers are generally composed of amorphous molecular chains; thus, the chains experience elongation from the electrostatic field during electrospinning. The resulting well-aligned, uniform molecular chains are necessary for the stable transferring of phonons (Asmatulu and Khan, 2019). Hydrogen bonding between the various functional groups of proteins and polymers restricts the movement of the intermolecular chains and the segmental rotations of the nanofiber molecules (Zhang et al., 2014). This restriction and uniformity in the molecules improve particle capturing. PPI/PVA nanofabrics with good thermal stability are feasible since Maftoonazad et al. (2019) have successfully developed homogenous nanofibers using these components. Furthermore, the hydrogen bonds present within the PPI/PVA nanofabrics slow down the oxidation and elimination of hydroxyl present within the nanofibers; thus, suppressing its thermal degradation.

3.2.2 Chemical Filtration Capabilities

The amino acid and functional group content of PPI/PVA nanofabrics are the main parameters that would influence its chemical filtration capabilities. PPI contains amino acids with ionizable side chains—such as lysine, histidine, and arginine—meaning they may accept or donate protons. Their surface charge due to electrospinning and their affinity for acid-base reactions have proven essential for antibacterial activity and attracting smaller charged pollutants such as gaseous particles (Dickson & Koochmaraie, 1989). Aside from ionizable side chains, amino acids also contain functional groups such as carboxyl, amino, and hydroxyl (Figure 6). PVA also has functional groups like hydroxyl, carboxyl, alkyl, carbonyl, and ether. In particular, the abundant hydroxyl groups attached to its carbon chain can form multiple hydrogen bonds. These functional groups exhibit chemical reactivity, meaning they can generate interactions (such as hydrogen bonding, ionic bonding, and charge-charge) with pollutants. Like the ionizable side chains, the functional groups attract electronegative particles using the positive charge gained from electrospinning (Lubasova et al., 2014). This charge-based interaction is referred to as electrostatic attraction and is the predominant mechanism of nanofabrics for dealing with toxic chemicals and bacteria.

Amino Acid Structure

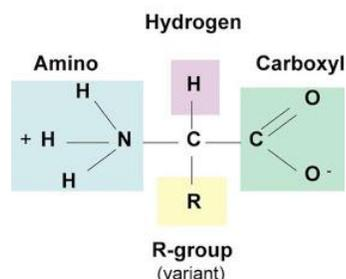

Figure 6. Basic amino acid structure from Javaid (2011).

Table 7 showcases the comparison of amino acid profiles between soy and pea protein isolates. The amino acids highlighted in the table contain ionizable side chains, and pea protein isolate contains equal or even greater amounts of these amino acids. The amino acids of SPI have proven essential in filtering toxic chemicals, as incorporating SPI into PVA nanofabrics tremendously raised the removal efficiency of formaldehyde and carbon monoxide (Table 8). Therefore, the similar amino acid content in PPI means PPI/PVA nanofabrics show great potential for chemical filtration. However, PPI must first be denatured to expose these functional groups fully.



	Pea	Soy		Pea	Soy
Non-essential amino acids			Essential amino acids		
Serine	2.5	2.3	Threonine	2.5	2.3
Glycine	0.3	0.3	Methionine	0.3	0.3
Glutamic acid	3.7	3.2	Phenylalanine	3.7	3.2
Proline	1.6	1.5	Histidine	1.6	1.5
Cysteine	4.7	3.4	Lysine	4.7	3.4
Alanine	2.7	2.2	Valine	2.7	2.2
Tyrosine	2.3	1.9	Isoleucine	2.3	1.9
Arginine	5.7	5.0	Leucine	5.7	5.0

Table 7. Amino acid content of pea and soy protein isolates measured in g per 100 g from Gorissen et al. (2018)

	SPI/PVA	PVA	HEPA Filter
Formaldehyde (HCHO)	62.50 %	31.23 %	< 5 %
Carbon monoxide (CO)	76.90 - 90.90 %	55.67 %	< 3 %

Table 8. Formaldehyde and Carbon monoxide removal efficiencies for different nanofabrics and HEPA filter

Further evidence for similar functional group content between PPI/PVA nanofabrics and other nanofabrics with similar components can be seen by analyzing their respective FTIR spectra (Figure 7). The various peaks at corresponding wavenumbers throughout the FTIR spectra signify the functional groups' presence within the nanofibers. Some examples include the peaks at wavenumbers 3000-3500 cm⁻¹ representing hydroxyl groups and Amide I & II groups at wavenumbers 1500-2000 cm⁻¹. The FTIR spectrum of the PPI/PVA nanofabric exhibited peaks at similar wavenumbers compared to the other nanofabrics, meaning a combination of PPI and PVA contain similar functional groups after being electrospun. These functional groups have proven essential for filtering PM_{2.5} and toxic chemicals due to the strong interactions they may exhibit; therefore, a PPI/PVA nanofabric for chemical filtration shows excellent promise.

4. CONCLUSIONS

The research aimed to assess the feasibility of developing PPI/PVA air filter nanofabrics via electrospinning by conducting a systematic review. PPI's globular nature and lack of molecular entanglement make it largely incompatible with electrospinning, while PVA is a polymer that has successfully been implemented in many electrospinning applications. A combined PPI/PVA solution is compatible with electrospinning under specific parameters and has resulted in nanofabrics with desirable properties. PPI/PVA nanofabrics have also shown potential filtration capabilities based on their similarity with other bio-based air filter

nanofabrics. Specifically, its physical filtration function stems from its sufficient fiber diameter, appropriate areal density, and high thermal stability. Its chemical filtration function stems from its desirable amino acid and functional group content and the robust intermolecular interactions between them and pollutants.

These findings serve as a foundation for developing another multifunctional and eco-friendly nanofabric that serves as an alternative to traditional air filters. Although the results were synthesized from many credible sources, they remain inferences without experimental evidence. Therefore, it is highly recommended that future researchers conduct laboratory experiments to truly develop PPI/PVA nanofabrics to verify this study's results. It is hoped that this study will contribute to the budding field of air filter nanofabrics and help readers further understand the importance of preserving clean, quality air.

5. ACKNOWLEDGMENTS

The researchers would like to express their deepest thanks to the people who devoted their time and expertise to help the researchers write their paper. They also wish to acknowledge their research adviser, Ms. Leah Madrazo, for her guidance and sagacious comments and suggestions that immensely helped curate this manuscript. They would also like to extend their gratitude to their parents for supporting and encouraging them in these trying times. The researchers would also like to acknowledge DLSU for providing them with the resources and databases to find the articles included in this review and for giving them this opportunity to enrich their knowledge and make an impact. Lastly, the study would not have been possible without the blessings of knowledge and perseverance received from God.

6. REFERENCES

Aslam, M., Kalyar, M. A., & Raza, Z. A. (2018). Polyvinyl alcohol: A review of research status and use of polyvinyl alcohol based nanocomposites. *Polymer Engineering & Science*, 58(12), 2119-2132. <https://doi.org/10.1002/pen.24855>

Asmatulu, R., & Khan, W. S. (2019). Chapter 12 - Electrospun nanofibers for photonics and electronics applications. *Synthesis and Applications of Electrospun Nanofibers*, 239-256. <https://doi.org/10.1016/b978-0-12-813914-1.00012-2>

Choy, S., Moon, H., Park, Y., Jung, Y. M., Koo, J. M., Oh, D. X., & Hwang, D. S. (2020). Mechanical properties and thermal stability of intermolecular-fitted poly (vinyl alcohol)/ α -chitin nanofibrous mat. *Carbohydrate*



- Polymers, 244, 116476.
<https://doi.org/10.1016/j.carbpol.2020.116476>
- Dickson, J. S., & Koohmaraie, M. (1989). Cell surface charge characteristics and their relationship to bacterial attachment to meat surfaces. *Applied and environmental microbiology*, 55(4), 832-836.
- Gorissen, S. H., Crombag, J. J., Senden, J. M., Waterval, W. A., Bierau, J., Verdijk, L. B., & Van Loon, L. J. (2018). Protein content and amino acid composition of commercially available plant-based protein isolates. *Amino Acids*, 50(12), 1685-1695.
<https://doi.org/10.1007/s00726-018-2640-5>
- Handoll, H., Gillespie, W., Gillespie, L., & Madhok, R. (2008). The Cochrane collaboration: A leading role in producing reliable evidence to inform healthcare decisions in musculoskeletal trauma and disorders. *Indian Journal of Orthopaedics*, 42(3), 247-251.
<https://doi.org/10.4103/0019-5413.41849>
- Jain, R., Shetty, S., & Yadav, K. S. (2020). Unfolding the electrospinning potential of biopolymers for preparation of nanofibers. *Journal of Drug Delivery Science and Technology*, 57, 101604.
<https://doi.org/10.1016/j.jddst.2020.101604>
- Król-Morkisz, K., & Pielichowska, K. (2019). Thermal Decomposition of Polymer Nanocomposites With Functionalized Nanoparticles. *Polymer Composites with Functionalized Nanoparticles*, 405-435.
<https://doi.org/10.1016/b978-0-12-814064-2.00013-5>
- Li, K., Li, C., Tian, H., Yuan, L., Xiang, A., Wang, C., Li, J., & Rajulu, A. V. (2020). Multifunctional and efficient air filtration: A natural nanofilter prepared with zein and polyvinyl alcohol. *Macromolecular Materials and Engineering*, 305(8), 2000239.
<https://doi.org/10.1002/mame.202000239>
- Lubasova, D., Netravali, A., Parker, J., & Ingel, B. (2014). Bacterial filtration efficiency of green soy protein based nanofiber air filter. *Journal of Nanoscience and Nanotechnology*, 14(7), 4891-4898.
<https://doi.org/10.1166/jnn.2014.8729>
- Maftoonazad, N., Shahamirian, M., John, D., & Ramaswamy, H. (2019). Development and evaluation of antibacterial electrospun pea protein isolate-polyvinyl alcohol nanocomposite mats incorporated with cinnamaldehyde. *Materials Science and Engineering*, 94, 394-402. <https://doi.org/10.1016/j.msec.2018.09.033>
- Moher, D., Liberati, A., Tetzlaff, J., Altman, D. G., & Prisma Group. (2009). Preferred reporting items for systematic reviews and meta-analyses: the PRISMA statement. <https://doi.org/10.1371/journal.pmed.1000097>
- NanoScience. (2019). Electrospinning. *Nanoscience Instruments*.
<https://www.nanoscience.com/techniques/electrospin/>
- Souzandeh, H., Wang, Y., Johnson, K., & Bhamidipaty, K. (2016). Soy Protein-Based Nano-Fabrics for High Efficient and Multi-Functional Air Filtration. *ACS Applied Materials & Interfaces*, 8(31).
<https://doi.org/10.1021/acsami.6b05339>
- Souzandeh, H., Wang, Y., & Zhong, W. H. (2016). "Green" nano-filters: fine nanofibers of natural protein for high efficiency filtration of particulate pollutants and toxic gases. *RSC advances*, 6(107), 105948-105956.
<https://doi.org/10.1039/C6RA24512A>
- Sandberg, A.-S. (2011). Developing functional ingredients: a case study of pea protein. *Functional Foods*, 358-382.
<https://doi.org/10.1533/9780857092557.3.358>
- Wright, R. W., Brand, R. A., Dunn, W., & Spindler, K. P. (2007). How to write a systematic review. *Clinical Orthopaedics and Related Research*, 455, 23-29.
<https://doi.org/10.1097/blo.0b013e31802c9098>
- Wu, G., Zhai, M., & Wang, M. (2019). Radiation technology for advanced materials: From basic to modern applications. Academic Press.
- Zhang, R., Liu, C., Hsu, P., Zhang, C., Liu, N., Zhang, J., Lee, H., Liu, Y., Qiu, Y., Chu, S., & Cui, Y. (2016). Nanofiber air filters with high-temperature stability for efficient PM2.5 removal from the pollution sources. *Nano Letters*.
<https://pubs.acs.org/doi/abs/10.1021/acs.nanolett.6b00771>
- Zhang, T., Wu, X., & Luo, T. (2014). Polymer nanofibers with outstanding thermal conductivity and thermal stability: Fundamental linkage between molecular characteristics and macroscopic thermal properties. *The Journal of Physical Chemistry*.
<https://pubs.acs.org/doi/10.1021/jp5051639>
- Zhang, L., Yuan, W. L., Zhang, Z., Zhang, G. H., Chen, H., Zhao, N., ... & Tao, G. H. (2019). Self-assembled ionic nanofibers derived from amino acids for high-performance particulate matter removal. *Journal of Materials Chemistry A*, 7(9), 4619-4625.
<https://doi.org/10.1039/C8TA11382C>



Characterizing Perceptions on Factors Associated with Cycling Behavior in the “New Normal”

Roland Gabriel R. Barcelona, Vinn Austin Hermoso, Samuel Francis D. Mendoza,
and Patrick Sean J. Tejada
De La Salle University Integrated School, Manila

Dr. Krister Ian Daniel Z. Roquel, *Research Adviser*
De La Salle University Integrated School, Manila

Abstract: The COVID-19 pandemic hindered transport systems globally. Its transmission is quick due to the dense living condition in metropolises, and mass transit systems soon became a hotspot for contracting the virus. As a result, individualized forms of transport became favorable. The study investigated other forms of individualized transport that hinders the spread of the virus and deters increasing the patronage for private cars. It also seeks to aid in the development of sustainable transport policies in Metro Manila. Accomplishing this required the perceptions of Metro Manila travelers on bicycling, their socio-demographic characteristics, and trip behavior. The data was gathered through an online survey, which were then analyzed and modeled using the descriptive statistics functions of MS Excel to determine which parameters motivate or demotivate travelers from using a bicycle. Results of the survey led to the conclusion that the cyclist’s security is a significant motivator and demotivator, and unlike its motivator counterpart, cost does not necessarily demotivate travelers from bicycling, but it is also advised to proceed with caution when interpreting the results for the cost motivator since these may also indicate a demotivation for private car use instead of primarily a motivation to use a bicycle for travel. These results were also disaggregated by trip length. It was found that long trip motivators generally held higher significance but this trend is not followed for both short and long trip demotivators which makes it seem that travelers are more easily demotivated to cycle.

Key Words: bicycle; active transport; barriers; opportunities; Metro Manila

1. INTRODUCTION

The COVID-19 pandemic brought upon a challenging hurdle for transportation around the world. Quarantine has been implemented, limiting public transportation operations because of the contact between people (Yoo et al., 2020). Higher capacities of mass transit do not correlate with an increase in volume inside the spaces, since high density of commuters in a space decreases the effectiveness of social distancing (Evans & Wener, 2007). However, using private vehicles is also not ideal. To compare, influenza, which has a similar transmission, is estimated to have a higher risk in a car as opposed to air travel with one infected person in the plane (L.D. Knibbs, L. Morawska, S.C. Bel, 2012).

Citizens who regularly travel have begun to use active transport as an alternative for the lack of public transportation due to its one-person capacity and compliance with existing quarantine protocols

(Cruz & Ives, 2020). Active transport provides essential mobility, physical fitness, and enjoyment (Litman, 2016). Lastly, the decrease of private vehicle use and increased physical activity may result in a reduced risk of diabetes, depression, and dementia in the general population (Woodcock et al., 2010).

The main objective of this research is to investigate the perceptions of Metro-Manila travelers toward bicycling as an alternative. Specifically, this study analyzed a few successful programs and to determine how to implement these in the local setting best. Determining these will aid the development of bicycling policies for the country.

The following section discusses the methodology. Section 3 covers the data analysis, while Section 4 concludes the study.



2. METHODOLOGY

2.1 Conceptual Framework

Contributing factors to implementation of bicycle policies were gathered from literature. The hypotheses are then formulated from the identified factors, which are evaluated through data gathering. An online survey with questions on both the motivators and demotivators for bicycling measured the perceptions of the respondents toward these factors. Socio-demographic characteristics of the respondents were also gathered. Measures of central tendency were used to compare relative significance among the factors. Finally, disaggregated data were analyzed in a similarly.

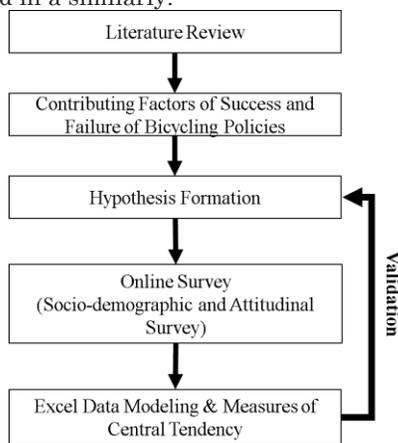

Figure 1. Conceptual framework

2.3 Materials and Procedure

On Appendix A, 233 samples were gathered using an online survey conducted using Google Forms from October 2020 to January 2021. Perceptions were quantified as the respondents' level of agreement with statements of the different factors on Table 1.

Table 1. Motivators and barriers for cycling

VARIABLE	BICYCLING MOTIVATORS	BICYCLING BARRIERS	ASSIGNED VALUES
Comfort and Convenience	There are establishments along the bicycle lanes	The frequency of extreme weather	Very likely (1) – Very unlikely (4)

Qualitative variables such as sex and educational attainment were assigned either 1 (Yes) or 0 (No) values. On the other hand, values of categorical class were used for scalar variables like travel frequency, while age utilized the actual values. Lastly, a Likert Scale from 1 to 4 (very likely and very unlikely, respectively) measured their perceptions. These numbers were assigned values 2, -1, 1, and 2, respectively.

3. RESULTS AND DISCUSSION

Demographic, Trip Conditions and Situations, and Bicycling Trip Preferences of Metro Manila Travelers

The percentage of sexes in Table 2 show similar results from the 2020 Labor Force Survey of the Philippine Statistics Authority. Next, respondent's age ranges from 22 to 54 years, the majority being young adults, employed, single, earn on average Php 29,206.01/month (est. 1 USD = Php 48.44) which reflects the high unemployment proportion, and all have finished compulsory education.

Table 2. Socio-demographic traits and travel behavior (general and by bicycle)

VARIABLES	PARAMETERS	COUNT(%)	MEAN (S.D.)
Sex	Male	105(45.06%)	-
	Female	128(54.94%)	
Age (years)	Exact value	-	29.3 (10.43)
Marital Status	Single	164(70.39%)	-
	Married	66(28.33%)	
	Annulled	1(0.43%)	
	Widow	2(0.86%)	
Educational Attainment	No formal education	0(0%)	-
	Elementary diploma	0(0%)	
	High School diploma	89(32.8%)	
	College degree	113(48.5%)	
	Masteral or higher	31(13.3%)	
Employment Status	Employed	122(52.36%)	-
	Unemployed	111(47.64%)	
Monthly Income (Php)	Less than 10,000	92(39.5%)	29,206.01 (29,215.65)
	10,000 –25,000	43(18.5%)	
	25,000 –45,000	48(20.6%)	
	45,000 –70,000	21(9.0%)	
	70,000 –100,000	13(5.6%)	
	More than 100,000	16(6.9%)	
Trip Purpose	Work	89(40%)	-
	Supermarket	72(32%)	
	Market	29(13%)	
	Others	35(15%)	
Travel Frequency (days/month)	< 1	40(17%)	-
	4 – 8	85(37%)	
	12 – 16	23(10%)	
	20 – 24	52(22%)	
	Everyday	33(14%)	
Transport Mode	Walk	18(8%)	-
	Bicycle	36(16%)	
	Mass Transit	34(15%)	
	Rideshare	10(4%)	
	Carpool	10(4%)	
	Private Car	122(53%)	
Travel Duration (minutes)	< 15	49(21%)	39.11 (31.76)
	15 – 30	84(36%)	
	30 – 60	55(24%)	
	60 – 120	34(14%)	
	> 120	11(5%)	
	Bicycle Ownership	Yes	
No	99(42%)		
Travel Frequency by Bicycle (days/month)	Never	124(53.22%)	4.56 (8.14)
	< 1	32(13.73%)	
	4 – 8	37(15.88%)	
	12 – 16	19(8.15%)	
	20 – 24	9(3.86%)	
	Everyday	12(5.15%)	
Travel Duration on Bicycle (minutes)	< 5	4(3.67%)	35.20 (19.03)
	5 – 15	16(14.68%)	
	15 – 30	33(30.28%)	
	30 – 60	29(26.61%)	
	> 60	27(24.77%)	



Most travel for work and supermarket, implying these are prioritized trips as seen on table 2. On the same table, majority report traveling for at most 4 to 8 days a month, and the disparity between private car users and the other modes (n=108) depicts people's fear of the virus when using mass transit. Lastly, bicycle users are slightly greater than mass transit users, implying an increase in bicycling activity.

Figure 2 presents that Metro Manila travelers usually depart from their homes at 8:00 AM and return at 5:00 PM, and most trips, both on and off the bicycle, last for 15 to 30 minutes as seen on Table 2. However, the higher responses for longer durations present the city's underdeveloped bicycling infrastructure. Furthermore, the high amount of long duration trips is likely a result of peak hours, especially since mass transit currently operate at limited capacities leading to increased private car usage (Abad, 2020).

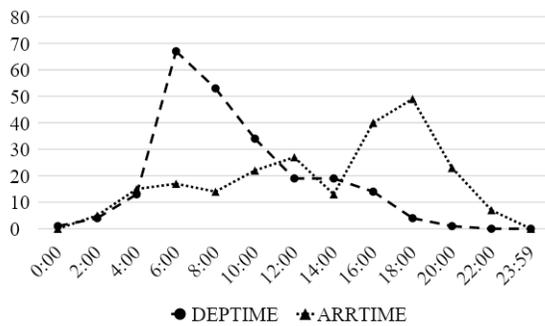

Figure 2. Usual departure and arrival time

Approximately 21% and 49% of bicycle owners have never or sparingly use their bicycles for travel, respectively as presented on Table 3, but the development of the bicycling infrastructure may increase these proportions (Cameña & Castro, 2016; Rissel et al., 2015). To add, Table 4 presents that respondents prefer: flexible pavement, leveled roads, and free-flowing traffic, but most built roads in Metro Manila are constructed with rigid pavement, have steady traffic, and are level. Thus, the problems lie with the current pavement type and traffic situation.

Table 3. Number of bicycle owners by travel frequency

PARAMETER (DAYS/MONTH)	COUNT(%)
Never	28(20.90%)
< 1	29(21.64%)
4 – 8	37(27.61%)
12 – 16	19(14.18%)
20 – 24	9(6.72%)
Everyday	12(8.96%)

Table 4. Bicycling preference of the respondents

VARIABLE	PARAMETER	CURRENT COUNT (%)	PREFERRED COUNT (%)
PAVEMENT TYPE	Rigid	57 (52.30)	58 (24.89)
	Flexible	42 (38.53)	163 (69.96)
	Unpaved	10 (9.170)	12 (5.150)
TERRAIN	Level	77 (70.64)	199 (85.41)
	Rolling	10 (9.170)	10 (4.290)
	Mountainous	22 (20.18)	24 (10.30)
TRAFFIC SITUATION	Free-flowing	32 (29.36)	188 (81.39)
	Steady	47 (43.12)	30 (12.99)
	Congested	30 (27.52)	13 (5.630)

3.2 An Overview on the Average Traveler's Perceptions on Bicycling

On Table 5, COST motivator parameters for an increase in fuel costs or parking fees likely motivates travelers to use a bicycle while the availability of cheaper bikes weakly do so. However, because 53% regularly use private cars, this may also be viewed as a demotivation for private car use rather than solely a motivator for bicycling. Equipping lanes with streetlamps and having a large cycling community shows promise for increasing ridership. However, SCRT presents the presence of traffic enforcement as a weak motivator. This is likely due to fear of encountering corrupt enforcers who accept incentives to drop a motorist's violations, a practice observed called 'kotong'. Finally, Figure 3 further proves the significance of security when traveling by bicycle as it is the most significant motivator.

Table 5. Summary of cycling motivators

VARIABLES (CODE)	PARAMETERS	MEAN(S.D.)
Cost (COST)	Vehicle fuel costs are increasing	1.03 (1.30)
	Vehicle parking fees are increasing	0.76 (1.39)
	Locally manufactured bicycles are promoted	0.34 (1.52)
Security (SCRT)	Installation of streetlamps along the bicycling lanes	1.26 (1.13)
	Seeing other bicyclists use the bicycling lanes	1.15 (1.16)
	Traffic enforcement is present	0.56 (1.44)
Safety (SFTY)	Bicycle repair stations or air stations are present along	0.41 (1.53)



	the bicycling lanes	
	Use of helmets and compliance w/ safety policies is strictly enforced	0.47 (1.58)
	Bicycle safety accessories are easily accessible for purchase	1.18 (1.13)
Information (INFO)	Bicycling lanes are clearly marked and separated from motor vehicle lanes	0.42 (1.67)
	Development and improvement of bicycling facilities are being covered by news reports	0.60 (1.47)
	Awareness campaigns on bicycling laws are promoted to motor vehicle drivers	0.29 (1.57)
Comfort&Convenience (COCV)	Bicyclists are not affected by vehicular traffic congestion	0.24 (1.60)
	Adequate lane widths for bicycling lanes are provided	0.00 (1.68)
	Presence of establishments along the bicycling lanes	1.12 (1.20)
Reliability (RLBT)	LGUs conduct routine road clearing operations	0.40 (1.57)
	Bicyclists have full control over their departure time	1.14 (1.24)
	Availability of first aid stations along the bicycling lanes	-0.40 (1.70)

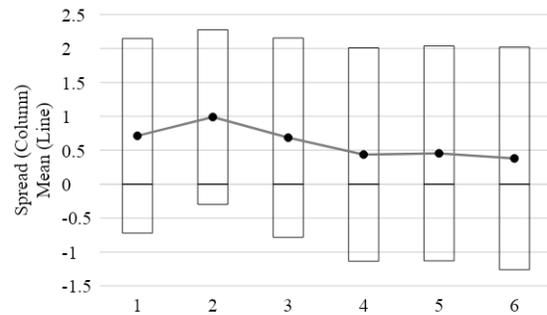

Figure 3. Plot of spread and mean of each motivator variable

SFTY on Table 5 shows that by making bicycle safety equipment more accessible, bicycling may improve patronage while the remaining show less significant results. Thus, it is advisable to plan a relationship that will benefit both stores and the bicycle infrastructure. To add, INFO presents the sensitivity of travelers toward news regarding bicycling. Thus, updating the public on the state of a city's bicycle infrastructure may increase ridership depending on how news is viewed.

Constructing bicycling lanes along establishments may increase bicycle ridership, however COCV on Table 5 shows that if these lanes occupy existing roads and further worsen traffic, dedicated lanes alone weakly motivate bicycle ridership. Thus, policies should achieve coexistence between bicycles and vehicles in Metro Manila. Interestingly, first aid on lanes weakly motivates Filipinos to cycle because they are likely already accustomed to frequent accidents. Furthermore, RLBT on the same table presents the preference of travelers to have full control over their departure time implying that they plan the shortest travel route and time possible.

On Table 6, COST shows most find owning bicycling locks unnecessary, expecting that establishments have these. Emphasis on the value of reducing crime rates along routes is visible from the SCRT results. Next, clearing the lanes of hazards and adding bicycle safety measures at intersections is necessary for them to consider bicycling. However, for the SFTY variable, insufficient bicycle lane networks may detract travelers from bicycling. Furthermore, bicycle safety knowledge, information on the bicycle infrastructure's state and the environment it is built on, and knowledge of bicycle routes that cyclists can take may avoid detracting travelers from cycling.



Table 6. Summary of cycling demotivators

VARIABLES	PARAMETERS	MEAN(S.D.)
COST	No bicycle available for use	-0.01(1.76)
	Bicycle locks are needed	0.95(1.46)
	Helmets and safety accessories are required by law	0.36(1.57)
SCRT	Prevalence of bike theft	1.15(1.27)
	General threat of crime	0.73(1.35)
	Lack of secure parking spaces for bicycles	1.18(1.29)
SFTY	Insufficient bicycle lane networks in my area	1.09(1.31)
	Obstructions are found on the bicycle lanes	0.96(1.29)
	“Bike boxes” are not provided at intersections	1.14(1.28)
INFO	Maps of bicycle routes in the city are unavailable	0.65(1.57)
	Areas with bicycle lanes are reported to have low air quality index	0.67(1.40)
	Lack of bicycle safety classes	0.98(1.27)
COCV	Extreme weather occurs frequently	0.94(1.30)
	Bicycling for long periods results in body aches	0.21(1.53)
	Bicycle lane networks are disconnected across neighboring towns and cities	1.18(1.28)
RLBT	Bicycle lanes are not consistently maintained	1.15(1.20)
	LGUs do not strictly enforce bicycling laws	1.06(1.30)
	Bicycle chains require frequent maintenance	0.41(1.49)

Table 6 shows the COCV variable presents the preference of travelers for weatherproof and continuous bicycle lanes. Thus, policies should mitigate both the issue of disjointed bicycle lanes and effects of extreme weather. Lastly, the respondents show more concern toward maintaining the infrastructure and policing system rather than the bicycle itself as seen on RLBT.

Figure 4 further proves that addressing SCRT, SFTY, RLBT of using bicycle lanes may improve the chances of increasing patronage. Thus, policies may primarily address the cyclists' security, bicycle lanes' safety, and bicycles' qualities sold at stores.

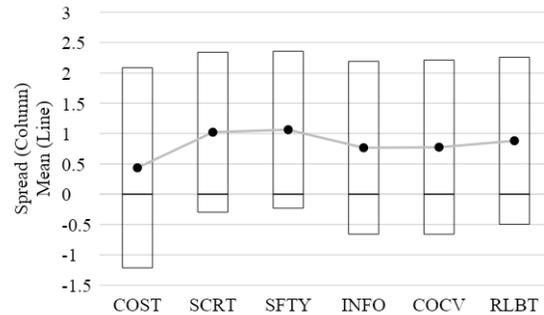

Figure 4. Plot of spread and mean of each demotivator variable

3.3 The Average Traveler's Attitudes on Bicycling by Trip Length

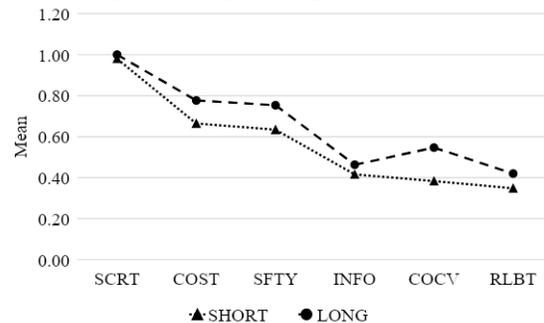

Figure 5. Trip motivators disaggregated by length

Generally, longer trips result in higher significance of a variable. Thus, the higher significance for long trip motivators on Figure 5 implies that most respondents cycle for longer periods which presents them to be more sensitive of these variables' effects. Lastly, the relatively low significance of INFO, COCV, and RLBT for both trip durations requires deeper investigation because results from earlier present that these variables are essential for increasing bicycle ridership.

Unlike on Figure 5, SFTY holds the most significance for both trip durations. Thus, increasing



bicycling patronage may require resolving the issues of rider safety when using the bicycle lanes. Furthermore, minute differences between the SFTY and INFO demotivators may indicate that travelers similarly value these variables for both durations. However, RLBT during longer trips becomes more significant, indicating a change in the trend observed earlier. The increase in RLBTs significance may indicate that travelers are more easily demotivated to cycle regardless of trip length.

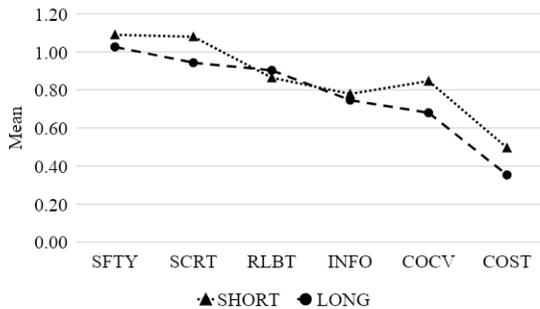

Figure 6. Trip demotivators disaggregated by length

4. CONCLUSIONS

This section will cap the study with recommendations for bicycle policy development, and the conduction of research for this topic.

The following are the recommendations for bicycle policy development based on the findings of this study: make bicycle safety equipment and accessories accessible to the public, present the benefits of bicycling while addressing the barriers and providing the preferences of the travelers for the bicycle lanes, identify the type of bicycle safety equipment that travelers want to personally own or expect to be shared then look into subsidizing the shared equipment, seek to achieve the coexistence of bicycling with the other transport modes, lastly is to not rely on data from studies conducted on foreign countries as Metro Manila travelers have shown behavior that deviate from the results of those studies.

Subsequent studies should take the succeeding recommendations into account. First is to replicate the methodology of this study in a normal, non-pandemic setting of Metro Manila to gain a point of comparison of the travelers' changes in perception during and after the pandemic. Second, enlarge and specify the study area in order to gain a comprehensive understanding of the perceptions of Metro Manila travelers from several locations of Metro Manila. Third, evaluate the parameters to be used by either replacing these with more appropriate parameters or by reframing the current parameters for these to better fit the main idea of each variable. Finally, establish communication with other researchers, LGUs, and government agencies who or

which are involved in the research and development of the bicycle infrastructure of the city.

5. ACKNOWLEDGMENTS

We wish to show our most profound appreciation to the Senior High School Practical Research directors of the De La Salle University. We also extend our gratitude to the online group administrators and moderators who assisted in disseminating the research survey questionnaire. Lastly, we would also like to thank the family and friends of the group members who provided important insights that contributed to completing the manuscript.

6. REFERENCES

Abad, M. (2020, June 8). FAST FACTS: State of Metro Manila's public transport system. Rappler. https://www.rappler.com/newsbreak/iq/things-to-know-about-metro-manila-public-transport-system?fbclid=IwAR00HvYLoj138DptDAhLZjGUoIx-JRggnLTwNiVgQhx_D35NVc1Nzu3V8I.

Cameña, J. P., & Castro, J. T. (2016). Identifying the Determinants of Walkability and Use of Non-Motorized Transport in a Medium-Sized City: The Case of Iloilo City, Philippines. 23rd Annual Conference of the Transportation Science Society of the Philippines, August. <http://ncts.upd.edu.ph/tssp/wp-content/uploads/2016/08/Camena-Castro.pdf>

Cruz, K. D. L., & Ives, M. (2020, December 13). When the Trains Stopped, Cyclists Dodged Manila's Choking Traffic. The New York Times. <https://www.nytimes.com/2020/12/13/world/asia/philippines-manila-bicycles-coronavirus.html?fbclid=IwAR2f3AxxUikCdhsre1OIdIY7aUDHq251MHYsOgz8Y27kIfup9dE-P8x9NV8>.

Evans, G. W., & Wener, R. E. (2007). Crowding and personal space invasion on the train: Please don't make me sit in the middle. *Journal of Environmental Psychology*. <https://doi.org/10.1016/j.jenvp.2006.10.002>

L.D. Knibbs, L. Morawska, S.C. Bel. (2012). International Laboratory for Air Quality and Health, Queensland University of Technology, Thoracic Medicine, The Prince Charles Hospital, Brisbane, Australia Corresponding author: L. D. Knibbs, International Laboratory for Air Quality and Health.

Rissel, C., Greaves, S., Wen, L. M., Crane, M., & Standen, C. (2015). Use of and short-term impacts of new cycling infrastructure in inner-Sydney, Australia: A quasi-experimental design. *International Journal of Behavioral Nutrition*



- and Physical Activity, 12(1), 1.
<https://doi.org/10.1186/s12966-015-0294-1>
- Woodcock, J., Edwards, P., Tonne, C., Armstrong, B. G., Ashiru, O., Banister, D., Franco, O. H., Haines, A., Hickman, R., Lindsay, G., Tiwari, G., Woodward, A., & Roberts, I. (2010). Public health benefits of strategies to reduce greenhouse-gas emissions: Urban land transport Delhi CO2 emissions transport Submitted to Ministry of Urban Development Government of India New Delhi Indian Institute of Technology Delhi. April.
- Yoo, J. Y., Dutra, S. V. O., Fanfan, D., Sniffen, S., Wang, H., Siddiqui, J., Song, H. S., Bang, S. H., Kim, D. E., Kim, S., & Groer, M. (2020). Comparative analysis of COVID-19 guidelines from six countries: a qualitative study on the US, China, South Korea, the UK, Brazil, and Haiti. BMC Public Health, 20(1), 1–16.
<https://doi.org/10.1186/s12889-020-09924-7>



Mung beans (*Vigna radiata*) as a Main Component in Bioplastic Synthesis: An Exploratory Research

Sophia Nhory S. Escasinas, Aaron De Angelo P. Lao, Jessa A. Pasia
and Frederick Tom C. Relos
Taytay Senior High School, Taytay, Rizal

Abstract: Non-biodegradable and single-use plastics became helpful to the masses, yet harmful to the environment. Thirty-five percent of plastics made for packaging, typically used once, are usually scattered or littered (Davis, 2015). Bioplastics are recently consolidated to potentially become an alternative to traditional plastics, which can reduce the dependency of plastic to petroleum and better disposal of plastic. With this in mind, investing in research and development with regards to bioplastics is much needed for our environment. Hence, promoting it as an advocacy should be uplifted (Thompson et al., 2009 cited in Pathak et al., 2014). This study aims to synthesize Mung beans (*Vigna radiata*) based bioplastic film as an alternative for non-biodegradable plastics gathering data on its properties using Solubility Test, Swelling Test, and Biodegradability Test. The result of the Solubility test revealed that the bioplastic material is soluble in the strongly acidic solvent and insoluble in the remaining solvents including distilled water after the soaking period. The Swelling test showed that there is a minimal difference in weight after the material was submerged in distilled water making it more preferable when it comes to manufacturing of bioplastic material. The Biodegradability test revealed that there is a massive change in weight after the soil burial period. Therefore, we conclude that the Mung bean starch based bioplastic film can be an alternative to single-use and non-biodegradable plastics and can be a solution to the existing and rising environmental issues caused by the continued use of non-biodegradable materials in numerous fields.

Key Words: bioplastic; biodegradable; mung beans; starch; environment

1. INTRODUCTION

The relevance of plastic to humans has grown immensely. This has led researchers to innovate an alternative plastic that is non-polluting, in hopes of solving the environmental problems. However, environmental problems are not yet fully resolved. This gave an opportunity for the destructive effect of plastic to increase exponentially (Koushal et al., 2014). On the grounds that garbage bins are still filled with plastic bags, pollution (land and water) and sewage problems continue to be a major issue of society. Consequently, floods have been said to be caused artificially by plastics followed by sewage problems, land, water, and air pollution. In addition, these lightweight packaging materials also carry adverse impacts, due to the fact that wind can carry them to undesired critical public places like trees, roadside ditches, or even in drains, rivulets, and rivers (Kakoti, 2017).

Bioplastics are recently consolidated to potentially become an alternative to traditional plastics, which can reduce the dependency of plastic to petroleum, as well as, better disposal of plastic. With

this in mind, investing in research and development with regards to bioplastics is much needed for our environment. Hence, promoting it as an advocacy should be uplifted (Thompson et al., 2009, cited in Pathak et al., 2014).

Mung beans belong to the family of legumes. Two of the main parts of legumes are protein and starch. Legume starch pastes are said to be more adherent than cereal starches because of higher resistance to swelling and rupture (Lineback & Ke, 1975, cited in Abdel-Rahman et al., 2008). Galvez and Resurreccion (1993), cited in Abdel-Rahman et al. (2008), exemplified that the amount of starch from mung beans is contingent on seed coats, the medium where it was soaked, and the length of time it was grinded.

Bio-based plastic exhibited high degradability in soil and compost systems, but most are not capable of finding ways in aquatic systems (Gil-Castell et al., 2016 cited in Thakur et al., 2018). The community's way of living may be magnified through the utilization of various bioplastic materials which can be useful to various fields such as agriculture, medicine, and the like; because the closest materials that may



potentially beat petrochemical based plastic in the future are biodegradable polymeric materials (Raza et al., 2018, cited in Thakur et al., 2018).

1.1. Central Problem

The use of non-biodegradable plastics gave rise to various environmental problems, it's also one of the modern days' biggest environmental issues. The widespread use of single-use plastics in product packaging caused public outrage over the environmental disasters caused by these wastes.

Hence, this study aims to synthesize an alternative for non-biodegradable plastics with the use of Mung Beans as its main component in the form of bioplastic.

1.2. Theoretical Framework

Eventually, usage and production of biodegradable polymer materials has been increasing in the interest of the public and scientific field over the past two decades as an alternative to plastics. Which is still needed to develop chemical and physical properties of synthetic plastics. As a result, a solution was proposed for the current problem of plastic waste (Reddy et al., 2003, cited in Pathak et al., 2014).

Bioplastic production is considered to be costly compared to petroleum based plastics. Theoretically, the plant provides a substitute solution to making these materials less expensive. In return, the plant hypothetically gives an elective answer for integrating these mass item products effortlessly. While the handling of PHA in microbes and yeast includes a costly aging interaction with outer wellsprings of energy, like power, it is more affordable in plant frameworks since it depends on water, soil nutrients, CO₂ and daylight. Moreover, a plant processing system is also more environmentally friendly (Bastoli, 1998, cited in Gill, 2014).

1.3. Existing Model

Given the theories gathered, the researchers used the methods of Prabhavat (1988) and Singh et al. (1989), as cited in Abdel-Rahman et al. (2008), in order to determine the efficient way of extracting mung bean starch that will be used in the bioplastic synthesis.

Note. Figure 1 shows the process of Mung bean starch extraction. From "Isolation and Physicochemical Characterization of Mung Bean Starches" by Abdel-Rahman et al., 2008, International journal of food engineering, 4(1), Materials section, Figure 1 (<https://doi.org/10.2202/1556-3758.1184>). CC BY.

Hence, this study proposes that these theories can be used to explore the said topic through prototype development and formulation with the use of the gathered related literature.

1.4. Research Questions

1.4.1. In what solvent/s is/are the Mung bean based bioplastic film soluble?

1.4.2. What is the result of a swelling test in each solvent after 2 hours of saturation?

1.4.3. In what depth is the Mung Bean based bioplastic the highest in terms of weight loss percentage after 7 days of soil burial process?

1.4.4. Is there a significant difference between the depth of soil burial and the weight loss percentage?

Ho . There is no significant difference between the weight loss percentage and the given depths.

1.5. Significance of the Study

This study aims to synthesize Mung bean based bioplastic as an alternative for non-biodegradable single-use plastics. This study may greatly affect single-use plastic consumers, entrepreneurs, future researchers, the community, the environment, and others as they can be aware and knowledgeable about the environmental effects of the plastics that they use and they can see how bioplastic can change one's way of living.

2. METHODOLOGY

This study aims to develop an alternative for non-biodegradable plastics with the use of Mung Beans (*Vigna radiata*) as its main component in the form of bioplastic. This study will use True Experimental Research design in product development and formulation.

In order to test the Swelling, Solubility and Degradation characteristics of the biofilm, the researchers will be using the instruments for the data collection process.

2.1. Preparation of Mung Bean Starch

Starch was extracted from Mung Beans bought from Taytay Public Market, Taytay, Rizal using the method adapted from Prabhavat (1988) and Singh et al. (1989), as cited in Abdel-Rahman et al. (2008).

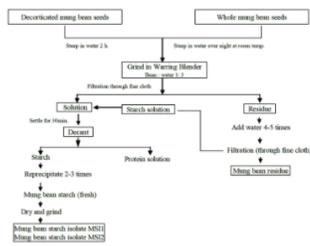

Figure 1. Isolation of Mung Bean Starch from Whole (MS1) and Decorticated (MP12) Mung Bean Seeds

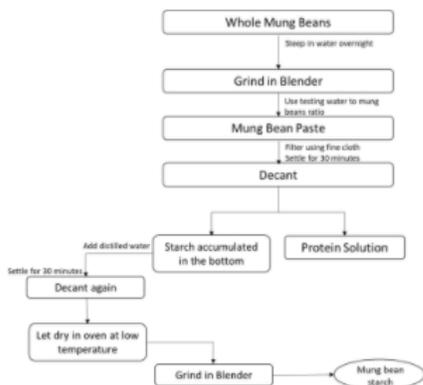

Figure 2. Mung Bean Starch Extraction Process

2.2. Preparation of Mung Bean Based Bioplastic Film

In order to make the bioplastic film, 25g of extracted Mung bean starch was put into the beaker followed by the addition of VG/PG glycerin, stirred using a stirring rod. Hydrochloric Acid (HCl) is then added while stirring to incorporate the mixture well. Dissolved Sodium Hydroxide (NaOH)-water solution (1:10 ratio) is then added in order to neutralize pH to 7. The mixture was poured into a petri plate and baked in the oven at 125 degree Celsius for drying. The petri plate was cooled in order to scrape the bioplastic film from the plate.



Figure 3. Mung Bean based Biofilm

2.3. Presentation of Data Collection Process

2.3.1 Solubility Test of Synthesized Mung Bean based Bioplastic in Different Solvents

Solubility test of the bioplastic material was conducted by following the procedure of Jayachandra

(2016) as cited in Rizwana et al. (2020). The sample was cut into 2cm by 2 cm square weighing approximately 0.75 grams and was placed inside of 16x150 individual test tubes containing 15 ml of specific solvents – distilled water, methanol, ethanol, and muriatic acid (HCl) for 30 minutes. Deliberate selection of solvents was done to distinguish the activity of material with variables such as polar, non-polar, and high acidic solvent.

2.3.2 Swelling Test of Synthesized Mung Bean based Bioplastic in Different Solvents

Swelling test of the specimen is conducted to observe the change in the material's original properties after synthesis by following the procedure of Jayachandra (2016) as cited in Rizwana et al. (2020). To validate the protuberance and other morphological changes, a pre-weighed piece of sample was utilized. Using the beaker test method, the samples were submerged in different beakers containing different solvents. Multifarious solvents such as water, methanol, and ethanol were used to soak the samples for approximately 2 hours and data were recorded appropriately.

2.3.3 Biodegradability Test of Synthesized Mung Bean based Bioplastic in Different Depths

Biodegradability test of the bioplastic material, was conducted by pre-weighting the specimen and using soil burial method. A garden soil that had 58.38% moisture content was measured at 800 grams. Afterwards, it was stored inside a container.

The samples were buried in depths of 2cm, 3cm and 4cm for 7 days having the same condition of soil moisture content and an average outside temperature of 32 degree celsius. The weight of each specimen was measured before conducting the test. Samples were periodically removed on the 1st, 3rd, 5th and 7th day of the burial period, washed with distilled water and dried before analysis. The dried films were weighed for monitoring weight loss (Jain and Tiwari, 2015). The biodegradability test was measured by Equation (Marichelvam et al., 2019):

$$\text{Weight Loss (\%)} = [(W_0 - W)/W_0] \times 100,$$

Wherein: W_0 is the weight before the soil burial (initial) and W is the weight after the test (7th day)

2.4. Scope and Delimitation

This study focuses on the Mung beans as a main component in bioplastic synthesis through product development with the use of the gathered related literature wherein the researchers reviewed and explored the evident components of Mung beans that contribute to its possibility to be used in bioplastic synthesis, which leads to testing its solubility, swelling and biodegradability.

The study limits the development of bioplastic using Mung beans with other active ingredients and tests on solubility, swelling, and biodegradability only and

does not include tensile strength test, SEM analysis, and other tests. The researchers may also gather data about the other topics or focuses stated above.

2.5. Ethical Consideration

We understand that as researchers we have the responsibility to uphold the ethics in research such that no animal or human will be used as a sample or during the trial period. Also, this is also to assure that we will observe ingenuity of our output, hence, if there are replications of similarities to other existing research projects it is not intentional.

3. RESULTS AND DISCUSSION

Through unit/thematic analysis and based on the research question/s the following findings were presented:

3.1. Presentation and Interpretation of Data

3.1.1. In what solvent/s is/are the Mung bean based bioplastic film soluble?



Figure 4. Solubility Test of Synthesized Mung Bean based Bioplastic in Different Solvents

Table 1. Solubility Test of Synthesized Mung Bean based Bioplastic in Different Solvents

Solvent Number	Solvents Used	Insoluble	Partially Soluble	Completely Soluble
1	Distilled Water	+	-	-
2	Methanol	+	-	-
3	Ethanol	+	-	-
4	Muriatic Acid (HCl)	-	-	+

The results of the solubility test were shown in Table 1. The results of the test presented that the sample was insoluble in water after 30 minutes of saturation making it more acceptable to be a material used in bioplastic based products. It is also insoluble in methanol (polar) and ethanol (non polar) and it is completely soluble in muriatic acid or HCl (strongly acidic). Solubility plays a major role in bioplastic synthesis as the material should have the capability of holding its structure after submerging it in different organic solvents.

3.1.2. What is the result of a swelling test in each solvent after 2 hours of saturation?



Figure 5. Swelling Test of Synthesized Mung Bean based Bioplastic in Different Solvents



Figure 6. Residue of Bioplastic film after Swelling Test

Table 2. Swelling Test of Synthesized Mung Bean based Bioplastic in Different Solvents

Solvent Number	Sample	Solvent Medium	Quantity (ml)	Initial Weight (g)	Final Weight (g)	Difference in Weight (g)
1	Synthesized Mung	Distilled Water	200	5.19	6.77	1.58
2	Beans Bioplastic	Ethyl Alcohol	200	5.54	4.06	-1.48
3	film	Methyl Alcohol	200	5.5	2.81	-2.69

The results of the swelling test were shown on Table 2. This showed that there is a slight negative change in the weight of the sample when it was soaked in ethanol and methanol, but slight increase in weight when soaked in distilled water with the same amount of solvent for 2 hours. The results from swelling tests show that there is a low amount of engorgement in water which is more ideal to be a bioplastic material.

3.1.3. In what depth is the Mung Bean based bioplastic the highest in terms of weight loss percentage after 7 days of soil burial process?

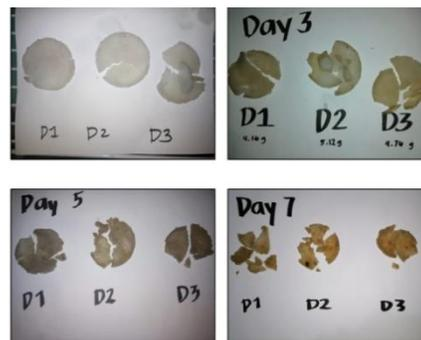

Figure 8. Bioplastic Film on 1st, 3rd, 5th, and 7th Day of Soil Burial Period in Different Depths

Table 3. Biodegradability Test of Synthesized Mung Bean based Bioplastic in Different Depths

Depth Number	Depth Used (cm)	Initial Weight (g)	Weight in Specific Number of Days				Difference in Weight (g)	Weight Loss Percentage
			Day 1	Day 3	Day 5	Day 7		
1	2	6.20	6.11	4.16	2.43	2.06	4.14	66.77%
2	3	6.50	7.33	5.12	2.59	2.18	4.32	66.46%
3	4	6.81	7.44	4.76	2.58	2.21	4.60	67.54%



The results of the biodegradability test were shown on Table 3. There is an evident change in the structure of the material before and after the test. A substantial variation in the texture was also shown by the bioplastic film. The table showed the biodegradability progression that occurred, with the existence of flaws and loss of filmy nature. Therefore, from the soil burial method and weight loss percentage result, it could be concluded that the bioplastics synthesized having Mung bean starch as its main component are biodegradable. The environmental factors such as temperature, moisture, and biological activity would affect the rate of degradation.

Biodegradability of 66.54% was achieved in 7 days for the sample placed in the soil at a depth of 4 cm, 66.46% in 3 cm, and 66.77% in 2 cm.

Table 4. Statistical Treatment of Biodegradability Test using One-way ANOVA

Anova: Single Factor

SUMMARY				
Groups	Count	Sum	Average	Variance
D1	5	20.96	4.192	3.84047
D2	5	23.72	4.744	5.28153
D3	5	23.8	4.76	5.65995

ANOVA						
Source of Variation	SS	df	MS	F	P-value	F crit
Between Groups	1.045973	2	0.522987	0.10614	0.900133	3.885
Within Groups	59.1278	12	4.927317			
Total	60.17377	14				

D1 vs D2	D1 vs D3	D2 vs D3	Critical Value
0.872789	0.898087	0.025298	2.17881283

3.1.4. Is there a significant difference between the depth of soil burial and the weight loss percentage?

From the results of the experiment, it may be concluded that there is no significant difference between the burial depth and the weight loss percentage as the P-value shown in Table 4 is .900133 using alpha 0.05. However, there is a significant difference between D1 vs D2 and D1 vs D3 with the LSD test result of 0.87279 and 0.89809 respectively

4. CONCLUSIONS

The result of the solubility test revealed that the bioplastic material is soluble in the strongly acidic solvent and insoluble in the remaining solvents including distilled water after the soaking period. The swelling test revealed that there is a minimal difference in weight after the material was submerged in distilled water which makes it more preferable when it comes to manufacturing of bioplastic based commercial products. The biodegradability test revealed that there is a change in weight after the soil

burial period. Therefore, we conclude that the Mung bean starch based bioplastic film can be an alternative to single-use and non-biodegradable plastics.

The results of the study showed the properties of the material that makes it an ideal alternative to be used in packaging and other activities and it can be a solution to the existing and rising environmental issues caused by the use of non-biodegradable materials in numerous fields. In order to study the properties of the material further, we recommend the utilization of other testing methods and manipulation of other factors such as pH level, humidity, soil moisture, solvent selection, and the likes. We also recommended the FTIR Analysis, Thermogravimetry Analysis, SEM examination, Tensile strength test, and other tests. We also recommend further study on the possible products that can be made using the material.

5. ACKNOWLEDGMENTS

We, the researchers would like to express our heartfelt gratitude to the following people whose assistance, guidance and support contributed a lot in conducting and accomplishing the paper for the courses of Practical Research I/II and Capstone.

To Dr. Ma. Victoria C. Magayon, our Research Teacher, who showed unconditional support, unselfish guidance, professionalism, sincere accommodation, and passion in imparting knowledge and encouragement from the start and until the end of this study.

To Mrs. Claire D. Vico, our Content Adviser, who encouraged us to face the challenges brought by different situations while we are doing the study and giving meaningful insights and suggestions regarding the research project.

To Mr. Marquis Cane A. Loria, our instrument validator, for his inputs that made us come up with more comprehensive tools.

To Ma'am Aileen I. Carbonell, our School Principal, who made our desire of being student researchers possible and made us appreciate the beauty of education.

To our classmates from 12-STEM A- Zara and 12-STEM B-Descartes who faced the challenge with us and contributed in the product development by showing their unending support.

The completion of this project could not have been accomplished without the understanding, encouragement, moral and financial support of our family and friends. Without them, we would have faced many difficulties while doing this study especially during these trying times.

And lastly, all praise and gratitude to the GOD Almighty, for the unending blessings while we are



doing this exploratory research and providing us enough strength, guidance and wisdom to pursue this study.

Sustainable Chemistry, 13, 68-75.
<https://doi.org/10.1016/j.cogsc.2018.04.013>

6. REFERENCES

- Abdel-Rahman, E. S. A., El-Fishawy, F. A., El-Geddawy, M. A., Kurz, T., & El-Rify, M. N. (2008). Isolation and physico-chemical characterization of mung bean starches. *International journal of food engineering*, 4(1).
<https://doi.org/10.2202/1556-3758.1184>
- Davis, H. (2015). Life & death in the Anthropocene: A short history of plastic. *Art in the anthropocene: Encounters among aesthetics, politics, environments and epistemologies*, 347-358.
- Gill, M. (2014). Bioplastic: a better alternative to plastics. *Int. J. Res. Appl. Nat. Soc. Sci*, 2, 115-120.
- Jain, R.; Tiwari, A. Biosynthesis of planet friendly bioplastics using renewable carbon sources. *J. Environ. Health Sci. Eng.* 2015, 13, 11.
<https://doi.org/10.1186/s40201-015-0165-3>
- Kakoti, R. (2017). Uses of plastic bags and environmental hazard-A study in Guwahati city. *Int. J. Appl. Res.*, 3(46), 1088-1094.
- Koushal, V., Sharma, R., Sharma, M., Sharma, R., & Sharma, V. (2014). Plastics: issues, challenges, and remediation. *International Journal of Waste Resources*, 4(1), 2-6.
- Marichelvam, M. K., Jawaid, M., & Asim, M. (2019). Corn and rice starch-based bioplastics as alternative packaging materials. *Fibers*, 7(4), 32.
<https://doi.org/10.3390/fib7040032>
- Pathak, S., Sneha, C. L. R., & Mathew, B. B. (2014). Bioplastics: its timeline based scenario & challenges. *Journal of Polymer and Biopolymer Physics Chemistry*, 2(4), 84-90.
- Rizwana Beevi, K., Sameera Fathima, A. R., Thahira Fathima, A. I., Thameemunisa, N., Noorjahan, C. M., & Deepika, T. (2020). Bioplastic Synthesis Using Banana Peels And Potato Starch And Characterization. *Int. J. Sci. Technol. Res*, 9, 1809-1814.
- Thakur, S., Chaudhary, J., Sharma, B., Verma, A., Tamulevicius, S., & Thakur, V. K. (2018). Sustainability of bioplastics: Opportunities and challenges. *Current Opinion in Green and*



A Prototype of D.I.Y. Landslide Alarm

Dexter Blair E. Andres, John Franky Nathaniel V. Batisla-Ong, and Eugene Ais
Taytay Senior High School, Taytay, Rizal

Abstract: Landslides can be described as a movement of soil, debris or rock down a slope caused by earthquake, rainfall or rapid snow melts. Many years back, it was considered as a potential hazard that can kill dozens of lives when not properly addressed. In the Philippines, many areas around certain regions are located in the possible hazardous places of a landslide. In order to address this problem, the researchers have created a device that can alert people regarding an upcoming landslide event. A wide array of literature has also created this kind of device and many of them are very successful. The researchers used different sensors like Acceleration and Gyroscope Sensor, Water Flow Sensor, and Soil Moisture Sensor to determine certain thresholds which can foretell an upcoming landslide. Each sensor has been tested in a variety of methods to establish the accuracy and functionality which is crucial for this kind of device. The researchers have found out the correct configuration of sensors so that they can be effective and useful. Just like any other mechanisms, a false alarm can always be expected. That is why the researchers are continuing to improve the prototype's functionality. The researchers recommend determining the quality of the sensors that are going to be used so that false alarms and other malfunctions can be prevented.

Key Words: low-cost; landslide alarm; do-it-yourself; sensors; modules; microcontroller

1. INTRODUCTION

Background of the Study

Landslides are one of the most dangerous geohazards world-wide and constitute a serious menace for public safety leading to human and economic losses (Park, 2011, cited by Formetta et al., 2016). Every year, thousands of lives are taken away by this unexpected slope failure while also destroying economical and infrastructural assets. It is impossible to stop a slope from failing but there are ways to mitigate or reduce the risk of slope failure (Akbar & Chen, 2017). The production and creation of different landslide alarms is evolving every day to perfectly suit the phenomenon itself (Ismail et al., 2017). In conceptualizing an early warning device, the possible threats like slope failure and heavy rainfall must be considered and taken into account. Possible ground movements require mechanisms that can detect slight changes in a slope's altitude and shall therefore be also present in the prototype's start up (Arbanas et al., 2011).

The phenomenon leads to the development of different types of early warning systems specifically designed to take the attention of the local community living in a landslide prone area. Early Warning Systems (EWSs) are defined as monitoring devices that can be applied to reduce the risk of natural hazards. They can warn a certain area for an incoming

phenomenon that may otherwise be lethal if not acted upon immediately (Medina-Cetina & Nadim, 2008 cited by Intrieri et al., 2013).

Many scientific groups have already created certain landslide alarms that use different methods of gathering data. An example of this is the utilization of ALOS / PALSAR imagery based on geomorphological satellite data interpretation to monitor landslide events (Schlögel et al., 2015). Certain research used a Geocube system with GPS sensors that span at a distance of at least 5 km which is capable of observing and monitoring the behavior of avalanches (Benoit et al., 2015).

Central Problem

As the future progresses, the locals need a more precise and accurate way of predicting landslides. A landslide alarm system that is cost-effective and easily understood without that need of increasingly complex mechanisms too advanced for those who are living near a landslide prone area, will significantly affect their living. This study aims to explore the possibility of creating a practical and simple landslide alarm system that can warn locals regarding a possible landslide incident in their area.

Theories

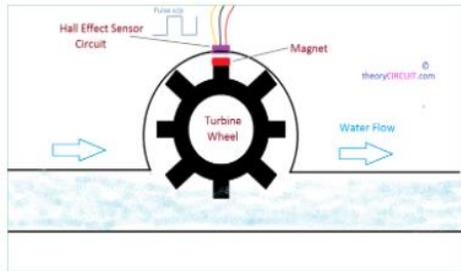

Figure 1. Hall Effect Theory

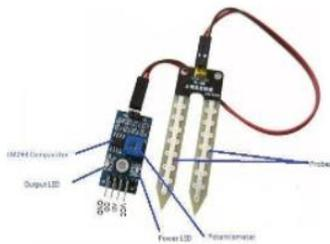
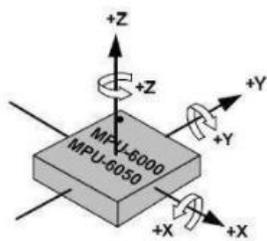

Figure 2. Soil Moisture Sensor Mechanism



Orientation of Axes of Sensitivity and Polarity of Rotation

Figure 3. MPU-6050 Sensitivity

Theoretical Framework

As shown in the first theory, the Hall Effect is utilized by a sensor called, Water Flow Sensor. The Hall Effect is the production of a voltage difference across an electrical conductor, transverse to an electric current in the conductor and a magnetic field perpendicular to the current. Hall Effect sensors are used for proximity switching, positioning, speed detection, and current sensing applications (Suresh et al., 2014). The sensor can measure the flow rate of the

fluid within the range of 1-30 liters per minute and can withstand water pressure less than or equal to 2.0 MPa. This sensor can be used to determine the volume of water that has passed through it. Therefore, it can be applicable as a rain gauge that will measure the volume of the rain that has already penetrated it.

The second theory pertains to the mechanism of a sensor called Soil Moisture Sensor. The soil moisture sensor is provided as a pair of cylindrical rods each coated with a thin layer of dielectric material, which is buried in the soil or other medium and is connected to a conversion circuit in which the electrodes act as a variable capacitance (Gluck et al., 1994). The soil moisture content of land masses affects the capability of soil to be stable. The higher soil moisture content the soil has, the more possible a landslide incident will occur.

The third theory talks about the sensor called MPU 6050. The MPU-6500 sensor is a 3-axis accelerometer and 3-axis gyroscope that can detect changes in a system's movement. It has a power consumption of 3-5 volts and can detect even the slightest concussions. This kind of sensor is also used for fall detection for senior citizens (Jefiza et al., 2017). Landslide systems shall have this kind of sensor to monitor the movement of the soil. The sensor, integrated to the prototype, can increase the functionality of the system.

Research Questions

Below are the proposed research questions that will be discussed in this study:

Proposed research questions:

What is the functionality level of the sensors?

soil moisture sensor b. water flow sensor

What is the difference between the functionality levels of the Prototype in terms of types of soil?

Is there a significant difference between the functionality levels of the Prototype in terms of types of soil?

Ho: There is no significant difference between the functionality level of the Prototype in terms of types of soil.

2. METHODOLOGY

2.1 Product Design

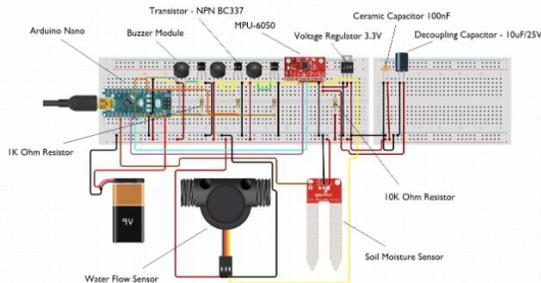

Figure 4. Pictorial representation of the Prototype

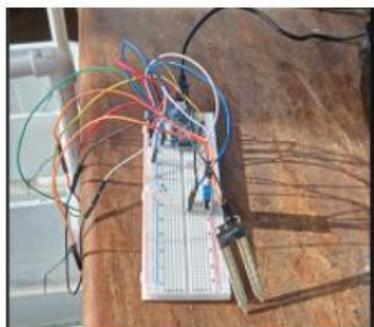

Figure 5. Actual design of the Prototype

2.2 Research Method

To ensure the functionality and efficacy of the prototype, the researchers have created several testing simulations for each of the sensors. The water flow sensor, soil moisture sensor, and the MPU-6050 were tested accordingly with different procedures to obtain necessary data that will then be used in further processing. The researchers were guided by a professional when the sensors were tested.

2.3 Data Collection Tool

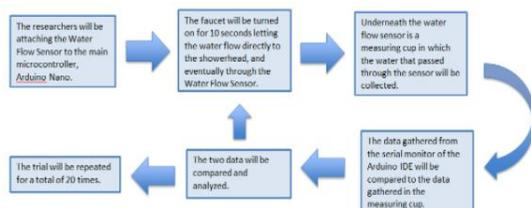

Figure 6. Water Flow Sensor Trial

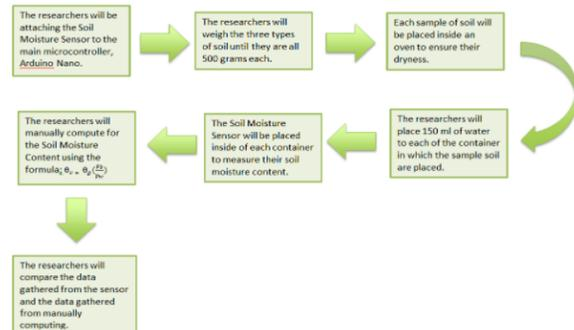

Figure 7. Soil Moisture Sensor Trial

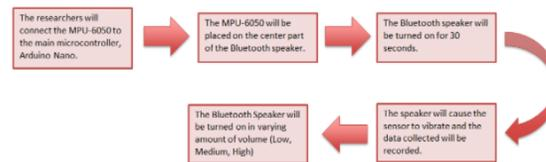

Figure 8. MPU-6050 Sensor

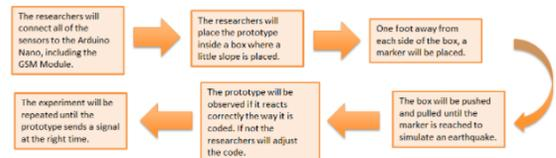

Figure 9. Movement Trials

2.4 Data Analysis

The statistical tool used by the researchers was One-way Analysis of Variance. This method is defined by the comparison of means from two or more samples. The statistical tool Percent Error was also used to determine the Accuracy and Reliability.

3. RESULTS AND DISCUSSION

Presentation of Data

The data gathered was based on the inquiry and presented by the research questions as follows:
What is the functionality level of the sensors?
(Accuracy Rate)
Soil Moisture Sensor
Water Flow Sensor



Table 1. Soil Moisture Sensor Trials

	Wet Weight	Dry Weight	Soil Moisture Data (Experimental)	Computed Data (Expected)
Sand	655 g	500 g	42%	45.6%
Loam	694 g	500 g	55%	40%
Clay	641 g	500 g	42%	42%

Table 2. Water Flow Sensor Trials

Experimental (ml)	Expected (ml)
66	120
171	140
207	160
117	250
184	145
232	165
173	155
128	140
63	115
150	150
47	105
458	260
74	80
52	80
94	125
88	120
74	120
60	130
35	100
211	155
192	130
175	170

Based on the gathered data from the trials conducted, the percentage error of the soil moisture sensor on sand, loam, and clay is approximately equal to 37.5%, 7.9%, and 0% respectively. To calculate these values, the researchers have used the formula stated on the methodology that relates the bulk density of each type of the soil to the volumetric soil moisture content.

After the Volumetric Soil Moisture Content is calculated, the percentage error can now be computed using the Percentage Error formula. This gives rise to the percentage error presented above.

The computation for the Percentage Error of the Water Flow Sensor comes from the mean value of both the experimental value and the expected values, which are 152.55ml and 155.75 ml, respectively. The formula for the Percentage Error, that is used for both the Soil Moisture Sensor and the Water Flow Sensor, is as follows:

$$\text{Percentage Error} = \frac{\text{experimental} - \text{expected}}{\text{expected}} * 100 \quad (1.1)$$

The water flow sensor gave off a percentage error of 2.07%, significantly lower, thus, can be concluded, more accurate. The researchers have conducted the same experiment 22 times to gather enough data for this value to be derived. This percentage error value can signal that the water flow sensor can be fully integrated to the prototype to increase its overall functionality.

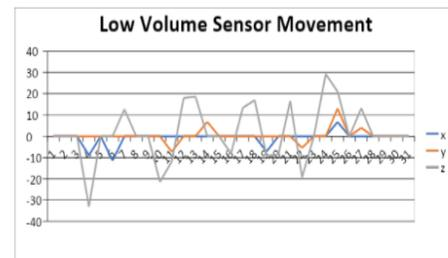

Figure 10. Low Volume Gyroscope Trials

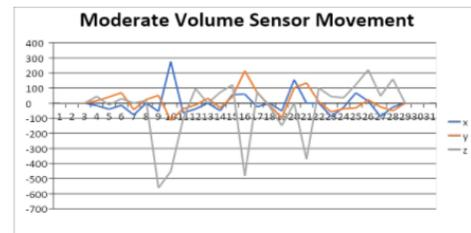

Figure 11. Moderate Volume Gyroscope Trials

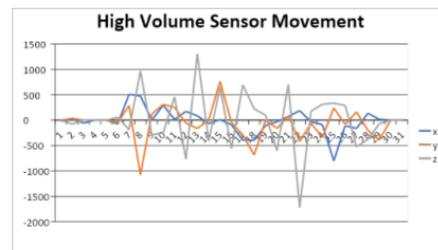

Figure 12. High Volume Gyroscope Trials



The MPU-6050 / Gyroscope's trials gave the result that the researchers expected. The ups and downs of the graph are proportional to the volume of the speaker which causes the vibration. The movements caused by this commotion reflect the expected outcome thus, proving its nonparametric functionality.

2. What is the difference between the functionality levels of the Prototype in terms of types of soil?

Table 3. *Prototype Trials*

Sand	Loam	Clay
5.23s	3.22s	4.46s
2.17s	4.26s	3.51s
4.5s	3.39s	4.07s

Note. The amount of time the prototype took to send an output signal (seconds)

The researchers have found out that the type of soil on which the soil moisture sensor is inserted affects the output data it can collect. As presented in Figure 15, the type of soil with the highest percentage error is loam. The researchers hypothesized that this phenomenon happens because of the impurities found in loam soil that affects the conductivity of the sensor itself. The variety of sawdust, rice straw and other organic materials are insulators that prevent the sensor from giving the right output, thus having a higher percentage error.

Trials conducted in sand gave off a significantly lower percentage error compared with loam. The fact that sand has more spaces in between each particle means that water can easily sink at the bottom of the container. This means that the data collected from the sensor can be off, the researchers hypothesized, for a certain margin because of this phenomenon.

The clay seems to be the best type of soil on which the sensor could work on. With a percentage error of 0%, the researchers believed that this is because of the fact that clay naturally sips water and distributes it equally in all parts. That is why the sensor readings are far more reliable since there are no impurities nor does water easily sink. This data however, is still inconclusive. Further trials must be conducted to truly identify the sensor's functionality.

3. Is there a significant difference between the functionality levels of the Prototype in terms of types of soil?

Table 4. *ANOVA: Single Factor for the three type types of Soil*

ANOVA						
Source of Variation	SS	df	MS	F	P-value	F crit
Between Groups	0.2721556	2	0.136078	0.131965	0.878847	5.143253
Within Groups	6.187	6	1.031167			
Total	6.4591556	8				

The researchers have also found out that the variety of soil did not affect the efficiency of the prototype's signal efficiency as shown in Figure 16. Also, in Figure it showed that the p-value is greater than the level of significance, hence, the null hypothesis is accepted.

Based on the works of Purnomo (2019), who had used a very similar methodology to this research, an instantaneous distance shift within the smallest scale of 0.4 mm can indicate a landslide event. They have created a system on which the significant data input came from the soil; whereas this research mostly relies on the data given by the atmosphere for it may also indicate a landslide event. The difference in this data structure can be varying at different times for there is a more suitable environment for the prototype to be tested.

4. CONCLUSIONS

The very purpose of this study is to create a landslide alarm system that could warn locals regarding a possible landslide incident in their area. The data gathered by the researchers using various trials have proven that the soil moisture sensor, water flow sensor, and the MPU-6050 are capable of such requirements. The soil moisture sensor was tested on different types of soil and based on the results, it can work best on clay soil. The water flow sensor has a percentage error of 2.07%. The MPU-6050, although no statistical treatments were applied, was observed to be functional.

As said above, the researchers have found out that the types of soil do not matter to the functionality of the prototype. The time it takes for the prototype to send an output signal (buzzer), is roughly the same whether the type of soil is changed. This means that the prototype can work with the same signal-sending efficiency even though the overall environment is changed. It can also be concluded that the prototype does not pick any particular soil on which it can work the best.

DISCUSSION AND RECOMMENDATION

The data gathered, together with the prototype created, has been found out to be effective and accurate on different aspects. After the trials, the researchers have realized several features that must



be done in order to improve the system. The prototype's functionality can definitely fulfill its goals if a little more time and effort is put into it. Even though some problems were experienced along the way, the researchers worked hard in order to put this product into its initial stages. The development will definitely be sure to follow because the researchers will work on it more after this study has been presented.

After the entire study is done, the researchers recommend to

Create a more stable enclosure for the sensors to sit in
Attach a solar panel module to increase the prototype's lifespan

Increase the prototype's functionality by adding another sensor called DHT22 (Temperature and Humidity Sensor)

Create a more rigid experimental design to test the functionality of the sensors.

Further, parametric statistical treatment is suggested to get the empirical data to determine the functionality of the MPU-6050.

5. ACKNOWLEDGMENTS

The researchers acknowledge all the authors who created the literature presented in this study. All of the data gathered are based on their hard work and commitment in the field of research and also for the sake of saving lives.

The researchers also acknowledge their research adviser for helping them create the entirety of the study. Without her intellect and passion, this study may have gone off the scratch since the beginning.

Also, the researchers would like to acknowledge themselves for the passion and determination they have given off. The hard work and effort will certainly pay off in the end.

The researchers also acknowledge the readers who have read, who are reading and those who will read their study. The researchers are doing it for them and for the sake of the people's lives this study is trying to save.

Lastly, the researchers would like to acknowledge the God Almighty for helping them finish the study. Without Him, the research would have not started at all. All thanks to Him, all is given to Him.

6. REFERENCES

Akbar, A. Q., & Chen, G. (2018). Comparison of major statistical methods and their combination using matrix validation for landslide susceptibility mapping. *Lowland Technology International*, 20(3, Dec), 401-412

Arbanas, Ž., Vivoda, M., Jagodnik, V., Dugonjić Jovančević, S., & Ljutić, K. (2011, December). Consideration of early warning system on the Grohovo Landslide. In *Proceedings of the 2nd workshop of the project's risk identification and land-use planning for disaster mitigation of landslides and floods in Croatia*, Rijeka (pp. 51-54)

Arduino and Soil Moisture Sensor -Interfacing Tutorial. (n.d.). *CircuitsToday*. <https://www.circuitstoday.com/arduino-soil-moisture-sensor>

Basics: Project 020a MPU 6050 GY 521 (GY-521) module 3 Axis Gyroscope and Accelerometer. (n.d.). *Acoptex*. <https://acoptex.com/project/118/basics-project-020a-mpu-6050-gy-521-gy-521-module-3-axis-gyroscope-and-accelerometer-at-acoptexcom/>

Beltran Jr, A., Dizon, K. J., Nones, K., Salanguit, R. L., Santos, J. B., & Santos, J. R. (2021). Arduino-based Disaster Management System. *Journal of Robotics and Control (JRC)*, 2(1), 24-28.

Formetta, G., Capparelli, G., & Versace, P. (2016). Evaluating performance of simplified based models for shallow landslide susceptibility. *Hydrology and Earth System Sciences*, 20(11), 4585-4603.

Gluck, I., Friedman, A., & Feniger, N. (1995). U.S. Patent No. 5,424,649. Washington, DC: U.S. Patent and Trademark Office.

Intrieri, E., Gigli, G., Casagli, N., & Nadim, F. (2013). Brief communication "Landslide Early Warning System: toolbox and general concepts".

Ismail, E. S. B., Habaebi, M. H., Ibrahimy, M., & Islam, M. R. (2018). Low-Cost Vibration Chamber for Landslide Sensory and Alarm System. *Indonesian Journal of Electrical Engineering and Computer Science*, 10(1), 110-119.

Jefiza, A., Pramunanto, E., Boedinoegroho, H., & Purnomo, M. H. (2017, September). Fall detection based on accelerometer and gyroscope using back propagation. In *2017 4th International Conference on Electrical Engineering, Computer Science and Informatics (EECSI)* (pp. 1-6). IEEE.

Nano, A. (2018). *Arduino Nano*.

Pecoraro, G., Calvello, M., & Piciullo, L. (2019). Monitoring strategies for local landslide early warning systems. *Landslides*, 16(2), 213-231.



Piciullo, L., Siano, I., & Calvello, M. (2016, June). Calibration of rainfall thresholds for landslide early warning purposes: applying the EDuMaP method to the system deployed in Campania region (Italy). In Proceedings of the International Symposium on Landslides (pp. 1621-1629).

Purnomo, F. A., Yoeseph, N. M., & Abisatya, G. W. (2019, February). Landslide early warning system based on arduino with soil movement and humidity sensors. In Journal of Physics: Conference Series (Vol. 1153, No. 1, p. 012034). IOP Publishing.

Schlögel, R., Doubre, C., Malet, J. P., & Masson, F. (2015). Landslide deformation monitoring with ALOS/PALSAR imagery: A D-InSAR geomorphological interpretation method. *Geomorphology*, 231, 314-330.

Srivastava, D., Kesarwani, A., & Dubey, S. (2018). Measurement of Temperature and Humidity by using Arduino Tool and DHT11. *International Research Journal of Engineering and Technology (IRJET)*, 5(12), 876-878.

Suresh, N., Balaji, E., Anto, K. J., & Jenith, J. (2014). Raspberry PI based liquid flow monitoring and control. *International Journal of Research in Engineering and Technology*, 3(07), 122-125.

Water Flow Sensor YF-S201 Arduino Interface. (n.d.). TheoryCircuit. <https://theorycircuit.com/water-flow-sensor-yf-s201-arduino-interface/>



TERPENES PROPERTIES AS BIOPESTICIDES

April Rose Q. Cañete, Carl Andrew M. Escuro, Reginald A. Roces,
and John P. Cammagay

Taytay Senior High school, Taytay, Rizal

Abstract: Biopesticide consists of many different types like plants, fungi, bacteria, microalgae and nowadays it is not yet widely introduced and rarely available in the market; common available pesticides are chemical-based pesticides that harm not only the environment but also humans. Plant essential oils are created from different plant resources, most of them are members of the mint family (Lamiaceae) and a multiple combination of a class of terpenes that consist of two-isoprene units or called monoterpenes composed of oils. It linked an aromatic compound with a molecular formula of C₆H₅OH or called phenols and a sesquiterpenes. Further research is needed in the emerging or happening of organic pesticides with showing the possible control agents, formulation, delivery and commercialization. Since the availability of biopesticides are minimal, the researchers come up with the idea of synthesizing a prototype of biopesticides from lemon peel, neem leaves, cinnamon bark and garlic using steam distillation as a mode of extraction of the essential property which is terpenes that holds a promising role in killing pest particularly aphids. The findings of this study aim to test the efficacy of the prototype made by the researchers which is the biopesticides that has extracts from lemon peel, neem leaves, garlic and cinnamon bark. The researchers are recommending the application of the prototype to the other pests and insects in order to know the effectiveness of it besides aphids.

Key Words: control agent; terpenes; aphids; biopesticides; steam distillation

1. INTRODUCTION

1.1. Background of the Study

Throughout the world, pesticides are widely used to secure a variety of crops (Desai et al., 2017). There is a harmful impact on using chemical pesticides and fertilizers that causes impotence of the soil, water hardness, genetic differentiation in plants, development of insect resistance, increase in toxic remains through food chain and animal feed that makes an escalation in health issues and many more (Srijita, 2015).

Due to the presence of pests that leads to damage of plant crops, the use of synthetic pesticides raises the call for secured foods as well as the ecological costs that it brings, which only shows the status of emerging studies in the field of biopesticides (Costa et al., 2019).

Residues that came from pesticide may cause a remarkable source of contamination of ecological factors such as air, soil, and water (Jayaraj et al., 2016). They have been reported to contaminate our environment as their residues accumulate in air, soil, water, animal tissue samples, and humans around the world (Desai et al., 2017). More usage by pesticides for the increased agricultural manufacture that brought to rise pollution of environmental sections (Jayaraj et

al., 2016). Regardless of their repressive effects on pests hazardous to plants and animals, pesticides can also be dangerous to human health and contaminate the environment (Mostafalou & Abdollahi, 2017; Albuquerque et al., 2018; Gomiero, 2018 cited by Costa et al., 2019).

A key role acts during this contact is that the Plant Secondary Metabolites (PSM) that may also act as nurturing deterrents through controlling the food intake of herbivores (Dearing et al., 2005, cited by Costa et al., 2019), changing hunting actions (Roy & Bergeron, 1989, cited by Costa et al., 2019) or breeding (Tran & Hinds, 2012, cited by Costa et al., 2019). Essential oils are believed to be one in all the very pleasing botanical pesticides because they are nontoxic to mammals, similarly not harmless within the environment (Isman, 2000 cited by Costa et al., 2019).

In 1995, the study by Pimentel presented that just a small percentage (0.3%) of valuable pesticides were set to the target pest; however the 99.7% moved anywhere else in the environment (Jayaraj et al., 2016). According to Aneja et al. (2016), further research is needed in the emerging or happening of organic pesticides with showing the possible control agents, formulation, delivery and commercialization.



1.2. Central Problem

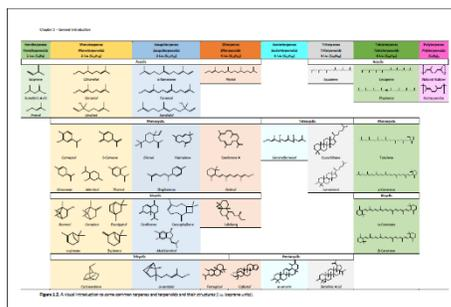

Due to pest infestation in crops and plants non-organic pesticides are invented and are widely used in the society and as an effect its residues leave traces in soils, air, and bodies of water that is adding to the pollution and more importantly causes harm to us.

On the other hand, plants are everywhere and most of all it has a lesser amount of danger to use. Based on the previous published researches terpenes properties are abundant in plants and have the possibility to be a component of biopesticide. In line with this, the researchers aim to synthesize a prototype of biopesticide with the property mentioned above which is terpenes.

1.3. Theoretical Framework

Multiple combination of a class of terpenes that consist of two isoprene units or called monoterpenes composing the oils. It linked an aromatic organic compound with a molecular formula of C₆H₅OH or called phenols and a sesquiterpenes (Nnamonu & Onekutu, 2015).

Essential oils (EO) biological activity and their components on pest insects comprise behavior and changes in feeding behavior, soap toxicity, and lethal toxicity via contact was reported by Castro et al. Their favorable mammalian toxicity and nonpersistence in the environment is the most attractive aspect of using Eos, that makes it exempted from registration in the United States of America (Vickers et al., 2009, cited by Boncan et al., 2020).

Volatile oils can be used for plants matrices using any kind of method categorized as conventional like using distillation with the use of water by heat as a way to bring out the total important material, and advanced which focus on the development in extraction competence by reducing extraction time, usage of energy, solvent, and CO₂ emission (de Matos et al., 2019).

Modes of EO extraction are precise to their hydrophobic and volatile nature. Hydro distillation and steam distillation that is accommodated in usual ways are for the majority of herb parts, and cold expression for citrus rind (Pejin et al., 2011, cited by

Maes et al., 2019).

Figure 2: Pesticidal Properties

Agriculture	
Pesticides	Pyrethrins, limonene
Plant protectors	Farnesene
Animal feed	Zeaxanthin
Phytohormones	Fusicoccans, abscisic acid

1.4. Existing Model

Figure 1: A visual introduction to some common terpenes and terpenoid and their structures (i.e., isoprene units).

These theories are also applied in the study of terpenes properties as biopesticides as well as the possibility that is related to these theories.

Hence, this study proposes that these theories can be true to explore the said topic through experimentation, and development of a prototype that will lead to answer the following questions.

Figure 3: Raw materials with pesticidal properties

Brazil nut family (Lecythidaceae)	S-methylmethionine,	Wood-boring longicorn beetles (Cerambycidae)	deterrent to specialist beetle seeking oviposition sites	[81]
Lavender (<i>Lamellula angustifolia</i>)	β-trans-ocimene, (+)-R-limonene	Aphids	deterrent to pest	[82]
Cucumber (<i>Cucumis sativus</i>)	tetracyclic terpenes: Cucurbitactins	Spider mite (<i>Tetranychus arboris</i>)	antibiotic effect on spider mites but attractive to the pest cucumber beetle	[83,84]
Cinnamon and clove	Eugenol, caryophyllene oxide, α-pinene, α-humulene and α-phellandrene	<i>Sitophilus granarius</i>	toxic and repellent effects to adult pest	[58]
Water primrose (<i>Lalage octovalvis</i>)	α-pinene, linalool oxide, geraniol, and phytol	Weber (<i>Africa cyanus</i>)	attractive to pest females	[85]
Rice (<i>Oryza sativa</i>)	(S)-linalool, 4,8-dimethyl-1,7-nonatriene, (E)-caryophyllene, and (R/S)-(E)-nerolidol	African rice gall midge (<i>Oryza argivora</i>)	attractive to mated female pest in intact rice, but repellent with different concentrations of the same volatiles in infested plant	[60]
<i>Eucalyptus grandis</i>	α-pinene, γ-terpinene	<i>Leptoclype inosus</i>	potentially attractive to pest	[86]
Various plant species	Geraniol	<i>Bemisia tabaci</i>	encapsulated geraniol shows attraction to <i>B. tabaci</i>	[87]

1.5. Research Questions

1.5.1. What is the effect of terpenes on the plant's aphids after applying it for 7 days?

1.5.2. Is there a significant difference between the result of treated and untreated?

1.5.3. Is there a significant difference between the results in three cases (mild, moderate, and extreme)?

1.5.4. What is the effect of terpenes on the leaves?

1.6. Significance of the study

This study will help:
Farmers

- this study can help them in minimizing the population of the pest.
- give them knowledge about terpenes properties.

Businessman

-this will give them an opportunity to develop biopesticide and improve what's in the market.

Experts

-this will serve as a reference for them to innovate ideas and the possibility of terpenes as biopesticide.

Future Researchers

-will give them additional ideas about the topic of biopesticide as well as the terpenes properties.

1.7. Scope and Delimitation Scope

The study through meta-synthesis and meta-analysis wherein the researchers gathered review of related literatures and synthesizes it to explore their chosen topic which is terpenes properties as biopesticides and produce a prototype out of it focuses on raw materials, formulation and the properties of the developed biopesticides.

Delimitation

The study limits only on terpenes properties and the formulation of biopesticides which means that the researchers will only collect information about raw materials connected to the topic. It also limits on the mentioned focuses above.

2. METHODOLOGY

This study aims to test the efficacy of the prototype made by the researchers which is the biopesticide that has extracts from lemon peel, neem leaves, garlic and cinnamon bark in controlling tomato plant's aphids.

2.1. Prototype of Terpenes Properties as Biopesticide

Figure 4. Sample of the Prototype of Terpenes Properties as Biopesticide



2.2 Research Design

The researcher used posttest only control design wherein the treated tomato leaves will be observed as well as the untreated to have a comparison between the two data after experimentation.

2.3. Experimental Design

2.3.1. Sampling procedure for the selection

The cases are classified as mild, moderate, and extreme wherein specific measurements are assigned:

Fig. 5.1. Mild - (1-15 mm of aphids)



Fig. 5.2. Moderate - (16-30 mm of aphids)



Fig. 5.3. Extreme - (31-45 mm of aphids)



2.3.2 Application of Terpenes Derivatives as Biopesticides

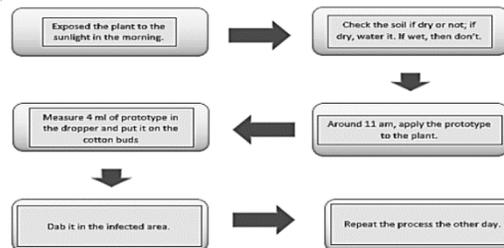

A prototype of pesticide is being tested on the leaves of tomatoes. The control group of leaves to be treated will be classified as a) mild case, b) moderate case, c) extreme case.

2.3.3. Data Gathering Procedure

Using the validated observation sheets, the researchers proceeded to the experimentation, in a span of seven days the tomato leaves' color and aphids' infection were observed as well as the untreated with



continuous application of the prototype. After the data gathering, the collected data was analyzed through statistical tools.

Cases	Day of Application						
	Day 1	Day 2	Day 3	Day 4	Day 5	Day 6	Day 7
NT							
T							

Changes	Cases							
	Day(s)	1	2	3	4	5	6	7
Green								
Light Green								
Yellow								
Brown								
Dried Up								

2.4. Data Analysis

The data gathered were tallied in a tabular form using Microsoft Excel and it is analyzed using non-parametric (frequency, percentage and mean) and parametric (two sample t-test and one-way analysis of variance) statistics.

2.4.1. Formula

2.4.1.1. Two-sample T-test

$$t = \frac{x_1 - x_2}{\sqrt{\frac{s_1^2}{n_1} + \frac{s_2^2}{n_2}}}$$

2.4.1.2. One-way Analysis of Variance

$$SS_{total} = \sum_{j=1}^p \sum_{i=1}^{n_j} (x_{ij} - \bar{x})^2$$

$$SS_{between} = \sum_{j=1}^p n_j (\bar{x}_j - \bar{x})^2$$

$$SS_{within} = \sum_{j=1}^p \sum_{i=1}^{n_j} (x_{ij} - \bar{x}_j)^2$$

3. RESULTS AND DISCUSSION

Based on the research questions the following data are presented:

3.1. What is the effect of terpenes on the plant's aphids after applying it for 7 days?

3.2. Is there a significant difference between the result of treated and untreated?

Presentation of Data

Table 1. Observation Sheets (Aphid's Growth Infection – Mild Case)

Cases	Day of Application						
	Day 1	Day 2	Day 3	Day 4	Day 5	Day 6	Day 7
Mild							
NT	14	20	35	51	56	71	100
T	14	7	5	2	0	0	0
Moderate							
NT	28	38	48	62	100	100	100
T	25	11	8	5	5	0	0
Extreme							
NT	38	38	47	55	66	100	100
T	35	24	14	9	3	1	0

T – Treated NT – Not Treated

Fig. 6.1. Graph that shows the growth of aphid's infection in mild case.

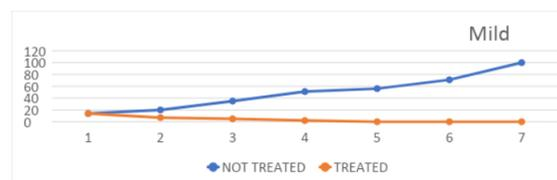

Fig. 6.2. Graph that shows the growth of aphid's infection in moderate case.



Fig. 6.3. Graph that shows the growth of aphid's infection in severe case.

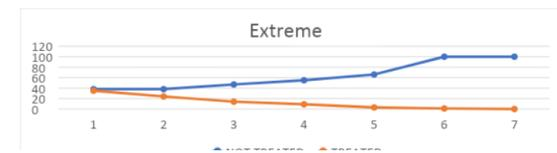

Table 2. Normal Distribution Data Table

	n	\bar{x}	s	Mild		
				df	Computed T-value	Critical Value
NT	7	49.6	30.37			
T	7	4	5.19	6	3.92	1.94
	n	\bar{x}	s	Moderate		
				df	Computed T-value	Critical Value
NT	7	1001.33	31.64			
T	7	73.9	8.60	6	4.87	1.94
	n	\bar{x}	s	Extreme		
				df	Computed T-value	Critical Value
NT	7	459.3	21.43			
T	7	171.9	13.11	6	4.74	1.94

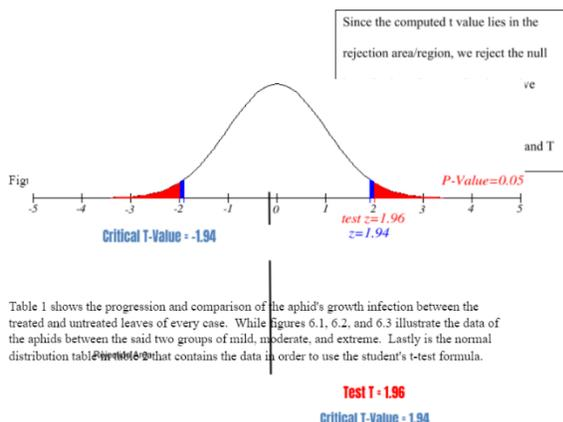

Table 1 shows the progression and comparison of the aphid's growth infection between the treated and untreated leaves of every case. While figures 6.1, 6.2, and 6.3 illustrate the data of the aphids between the said two groups of mild, moderate, and extreme. Lastly is the normal distribution table that contains the data in order to use the student's t-test formula.

3.2. Is there a significant difference between the result in three cases (mild, moderate, and extreme)?

Table 3. Anova Single Factor Data Table

Anova Single Factor						
Summary						
Groups	Count	Sum	Average	Variance		
T1	7	28	4	27		
T2	7	54	7.714286	73.90476		
T3	7	68	12.28571	171.9048		
Anova						
Source of Variation	SS	df	MS	F	P-Value	F-Crit
Between Groups	241.1429	2	120.5714	1.325886	0.290293	3.554557
Within Groups	1636.857	18	90.93651			
Total	1878	20				

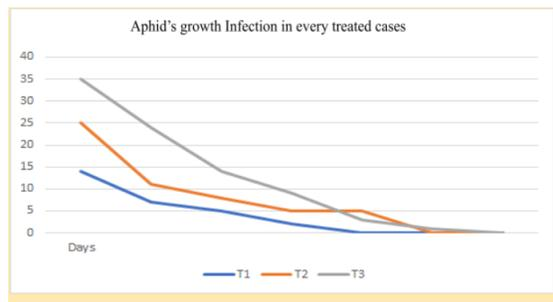

Fig. 7. Graph that shows the growth of aphid's infection in every treated case.

Table 3 shows the data computed using Microsoft Excel one way anova single factor and figure 7 shows the downfall of the growth of pest.

3.3 What is the effect of terpenes on the leaves?

Table 4.1. Effects of Terpenes on Leaves – Mild Case

Changes	Mild						
	Day(s)						
Green	1	2	3	4	5	6	7
Light Green	+	+	+	+	+	+	+
Yellow							
Brown							
Dried Up							

Table 4.2. Effects of Terpenes on Leaves – Moderate Case

Changes	Moderate						
	Day(s)						
Green	1	2	3	4	5	6	7
Light Green	+	+	+	+	+	+	+
Yellow							
Brown							
Dried Up							

Table 4.3. Effects of Terpenes on Leaves – Severe Case

Changes	Extreme						
	Day(s)						
Green	1	2	3	4	5	6	7
Light Green	+	+	+	+	+	+	+
Yellow		+	+	+	+	+	+
Brown							
Dried Up							

Tables 4.1, 4.2 and 4.3 indicate the changes on leaves using a heat map wherein color of leaves are being observed.

Observation Sheet (Aphid's Growth Infection)

The result of data shows that there is a significant difference between the treated and untreated cases which are mild, moderate and severe. As the experimentation goes by the aphid's growth infection in the treated cases are already gone while the untreated cases continue to increase the number of pests on its leaves.

Effects of Terpenes on leaves

The researchers observed discoloration on leaves as it lightens all throughout the experimentation process, factors such as the condition of plants, changes in temperature, breaking down of chlorophyll and such should be considered.

4. CONCLUSIONS

The study found out that the biopesticide prototype showed an enormous significant difference between the treated and untreated tomato leaves in every case. The outcome of the experiment revealed a huge decrease of the population of aphids as the day passed until it wiped out all the aphids in the treated leaves. In the same effect, data showed that between the three cases number of aphids it showed that there is no significant difference. This is only indicated that the biopesticide prototype is effective in whatever cases (mild, moderate, and extreme).

However, mild discoloration in leaves observed when the biopesticide prototype was applied. Out of all the results gathered the researchers concluded that the prototype terpenes properties as biopesticides has



potential to be a controlling agent for aphids in plants.

5. ACKNOWLEDGMENTS

The researchers recommend the following based on the result of the study:

A further research is needed wherein factors like aphid's growth infection, discoloration on leaves should be modified in order to increase the accuracy of the prototype. More efficient way of applying the prototype on the infected leaves by aphids.

The researchers would like to express their heartfelt thanks to the following people whose assistance, guidance and support contributed a lot in conducting and accomplishing this paper.

First of all, to our God Almighty who gives us strength and knowledge to accomplish our paper with strength and courage despite this pandemic.

To Dr. Ma. Victoria C. Magayon our research teacher, for her guidance and patience to help us in revising and teaching us the step-by-step procedure in doing each course task and for investing her time for us, students.

To Mrs. Vivian V. Tirados, our adviser for giving her full support all throughout the process of this study as well as in validating our research instrument that gives us a lot of enlightenment.

To our beloved classmates who are more than willing to help us on the parts that may seem hard for us and in encouraging each other through times that we are thinking of giving up.

Lastly, to those people who have not been mentioned, your efforts are well-appreciated, we will not be able to accomplish what we have done right now without all the support that you've given us.

6. REFERENCES

- Aneja, K. R., S. A. Khan, and A. Aneja. "Biopesticides an eco-friendly pest management approach in agriculture: status and prospects." *Kavaka* 47 (2016): 145-154
- Boncan, D. A. T., Tsang, S. S., Li, C., Lee, I. H., Lam, H. M., Chan, T. F., & Hui, J. H. (2020). Terpenes and Terpenoids in Plants: Interactions with Environment and Insects. *International Journal of Molecular Sciences*, 21(19), 7382.
- Costa, Jorge Alberto Vieira, et al. "Potential of microalgae as biopesticides to contribute to sustainable agriculture and environmental development." *Journal of Environmental Science and Health, Part B* 54.5 (2019): 366-375.
- de Matos, Sheila P., et al. "Essential oils and isolated terpenes in nanosystems designed for topical administration: A review." *Biomolecules* 9.4 (2019): 138.

Desai, Ketaki R., et al. "MITIGATION OF EARLY DELTAMETHRIN INDUCED HEPATOTOXICITY IN MALE MICE OF SWISS STRAIN BY ALLIUM SATIVUM." (2017).

Jayaraj, Ravindran, Pankajshan Megha, and Puthur Sreedev. "Organochlorine pesticides, their toxic effects on living organisms and their fate in the environment." *Interdisciplinary toxicology* 9.3-4 (2016): 90-100.

Maes, Chloë, Sandrine Bouquillon, and Marie-Laure Fauconnier. "Encapsulation of essential oils for the development of biosourced pesticides with controlled release: A review." *Molecules* 24.14 (2019): 2539.

Malini, Desak Made, M. Madihah, and Euis Julaeha. "Histological Structure of Mice (*Mus Musculus* L.) Liver after Administration of Ethanol Extract and Spinasterol from *Senggugu* (*Clerodendron Serratum* L) Leaves." (2015).

Martins, M. A. R. (2017). Studies for the development of new separation processes with terpenes and their environmental distribution (Doctoral dissertation, Universidade de Aveiro (Portugal)).

Nnamonu, Lami A., and Amana Onekutu. "Green pesticides in Nigeria: an overview." *Journal of Biology, Agriculture and healthcare* 5.9 (2015): 48-62.

Srijita, Dutta. "Biopesticides: An ecofriendly approach for pest control." *World Journal of Pharmacy and Pharmaceutical Sciences (WJPPS)* 4.6 (2015): 250-265.



Agaricales Production: A Systematic Review on its Representative Species' Cultivation Process and Substrate Influence

Riana D. Almodovar, Marybel R. Cornejo, Micah M. Mendoza,
and Joseph R. Naval

De La Salle University Integrated School, Biñan City, Laguna

Abstract: Mushroom cultivation has long been of economic importance, specifically in Asian nations where most mushrooms are grown and sold. The globally popular *Pleurotus ostreatus* and a mushroom with similar composition profiles to it, *Calocybe indica*, are gaining recognition among farmers in urban areas due to their low-cost production and ability to grow on diversified substrates. Assessing the cultivation of both *C. indica* and *P. ostreatus* with selected substrates has been unexplored by researchers, most especially systematic reviews that focus on the cultivation of mushrooms in the Philippines. This paper sought to find the effectiveness of wheat straw, paddy straw, and sugarcane bagasse substrates in increasing specific growth parameters of *C. indica* and *P. ostreatus*. A systematic review with a narrative synthesis approach was performed to determine the effects of the chosen substrates on growth and yield parameters. The study utilized the Preferred Reporting Items for Systematic Reviews and Meta-Analyses (PRISMA) as a basis for reporting the results and the Cochrane risk-of-bias tool to appraise the studies included in the review critically. Results show that wheat straw had increased the rate of spawn run and pinhead formation of both mushrooms, while paddy straw obtained high yield parameters. Though there was a lack of substantiation of a leading substrate among the three, paddy and wheat straw are substrates that might have the potential in increasing the mushroom's yield and quality in the Philippines.

Key Words: mushroom cultivation; *Pleurotus ostreatus*; *Calocybe indica*; lignocellulosic substrates; systematic review

1. INTRODUCTION

Mushrooms are a group of macro-fungi unable to perform the process of photosynthesis. Therefore, they feed on the nutrients of organic matter by releasing enzymes that decompose their organic material. These fruiting bodies belong to the kingdom Fungi under Phylum Basidiomycota and Ascomycota. However, most edible and commercially cultivated fungi belong to Basidiomycota under the order of Agaricales (Rahi & Malik, 2016). One species under Agaricales would be the *Pleurotus ostreatus*, otherwise known as Oyster mushrooms. They are low in maintenance, easy to cultivate, and can tolerate and thrive in a wide range of temperatures and climatic conditions (Sbhatu et al., 2019; Bellettini et al., 2019). According to the National Horticulture Board (n.d.), *P. ostreatus* thrives in an environment with a temperature of 20°C to 30°C and humidity of 55% to 70%. They productively grow on various lignocellulosic wastes, making them simple to produce. One mushroom that is also capable of thriving over a selection of lignocellulosic wastes is *Calocybe indica*. This fungus is cultivated in South

India and other South Asian countries and is most suitable for tropical regions. This mushroom's cultivation is low-cost and can be grown throughout a year (Samonte, 2014). *C. indica* has a high fruit yield of 100% to 800% (Spowart, 2017) and is also less perishable than other fungi whose shelf life is only a week at room temperature. Though *C. indica* possesses properties similar to the *P. ostreatus*, no research that focused on assessing both *C. indica* and *P. ostreatus* with selected substrates as their focused subject was found.

Additionally, no systematic review focuses on the potent mushroom cultivation that concentrates on the Philippines. Thus, a systematic review is needed to analyze both mushrooms' substrate efficacy. This study aims to critically assess all relevant investigations related to Agaricales production in answering research questions that address the effectiveness of various lignocellulosic substrates in increasing specific growth and yield parameters of *C. indica* and *P. ostreatus*.

This review was confined to literature situated in Asia and had used wheat straw, paddy straw, and sugarcane bagasse as their substrates.



These agro-wastes are frequently used in a plethora of studies involving *P. ostreatus* and *C. indica* cultivation. While it was stated that this paper was limited to the three mentioned substrates, at least one of the three is required in a study due to the limited research conducted on the topic. Different growth and yield parameters were used to evaluate each substrate's influence, namely, spawn run, pinhead formation, total yield, and biological efficiency.

Spawn run and pinhead formation were the first two steps for mycelial growth that primarily focus on its substrate colonization duration. On the other hand, the total yield and biological efficiency exhibited the substrates' effect on the fruiting bodies' overall growth.

This study's findings will be beneficial to Filipino mushroom farmers, for a thorough analysis of the strategies and substrates in increasing mushroom production will be imparted to them. It offers an opportunity for milky mushrooms to be introduced to the Philippine mushroom industry. It also encourages rice and sugarcane farmers to invest in mushroom production since it is an environment-friendly alternative to managing their wastes. Additionally, future researchers may use these findings as evidence of the selected substrates' influence towards both mushrooms' growth parameters.

2. METHODOLOGY

2.1. Research Design

A systematic review was conducted to provide evidence of the substrate efficacy in the cultivation parameters of both *C. indica* and *P. ostreatus*. Studies were gathered and critically assessed in different criteria and biases to ensure the quality of the review's findings. A narrative synthesis, accompanied by graphical data presentations, was used in analyzing the results from the eligible literature.

2.2. Search Strategy

Due to physical limitations, purely electronic databases accessible through the University Library were used for gathering literature to review. These databases include the following: SciFinder, ScienceDirect, and AnimoSearch. Keywords were formed from the research questions combined with truncation symbols. Table 1 includes the keywords used with the respective database.

2.3. Inclusion and Exclusion Criteria

Table 1. Electronic databases utilized in the systematic review

Database	Search Strategy
SciFinder (15,367 results)	(<i>Calocybe indica</i> OR <i>Pleurotus ostreatus</i>) AND (~yield OR ~morphological properties OR ~Agronomic OR ~cultivation)OR(~paddy straw OR ~wheat straw OR~ sugarcane)OR (Lyophyllaceae OR Pleurotaceae)
ScienceDirect (35,387 results)	(<i>Calocybe indica</i> OR <i>Pleurotus ostreatus</i>) AND (yield OR morphological properties OR Agronomic OR cultivation)OR(paddy straw OR wheat straw OR sugarcane)OR (Lyophyllaceae OR Pleurotaceae) Year: 2013 to 2020
Animosearch (5,153 results)	(<i>Calocybe indica</i> OR <i>Pleurotus ostreatus</i>) AND (yield~ OR morphological* OR Agronomic~ OR cultivation*~)OR(paddy straw~ OR wheat straw~ OR sugarcane ~)OR (Lyophyllaceae* OR Pleurotaceae*)

To secure the eligible articles' quality, the researchers screened the studies through the inclusion and exclusion criteria. A study was included for the following reasons:

It included at least one of the three target substrates. It investigated the substrates' effects using the following parameters: spawn run, pinhead formation, total yield, and biological efficiency.

It focused on the cultivation of the *C. indica* or *P. ostreatus*.

It has an experimental research design with at least two replications of the experiment.

Its methodology was conducted in vitro and within an Asian country.

On the other hand, a study was excluded for the following reasons:

It addressed another concept aside from cultivation.

Its full-text cannot be accessed due to premium publication restrictions.

It was written in a language aside from English.

Its publication date exceeded seven years from the present time.

It was not a peer-reviewed article.

2.4. Study Selection

Researchers followed the Preferred Reporting Items for Systematic Reviews and Meta-Analyses (PRISMA) Flowchart for eligible articles' screening process. Titles and abstracts were first screened concerning the topic. Afterward, the inclusion and exclusion criteria were applied to the screened articles with their full text, followed by the critical assessment review. The remaining articles were considered eligible studies for the review. Data were then extracted, including the study design and characteristics, the substrate used, and the outcome parameters.

2.5. Risk of Bias Assessment

Risk of bias assessment was conducted following the Cochrane risk of bias tool to ensure validity and objectivity from the eligible articles. The following criteria were used in the assessment: (1) performance bias, (2) detection bias, (3) attrition bias, and (4) reporting bias. Assessments were rated as uncertain, high, or low. Results were presented in a table showing the included study and the degree of bias present based on the researchers' individual and group assessments.

3. RESULTS AND DISCUSSION

3.1 Study Selection

This systematic review included ten studies. A flow chart of the identification and inclusion of studies is presented in Figure 1.

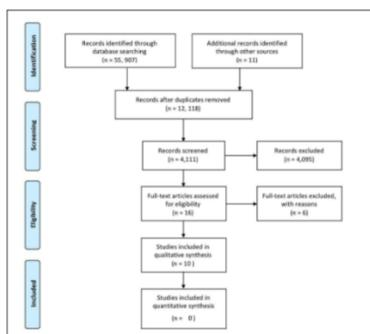

Figure 1. Flow chart of the study selection process in accordance with the Preferred Reporting Items for Systematic Reviews and Meta-Analyses (PRISMA) statement

3.2 Risk of Bias Assessment

The final ten journals chosen reached an overall judgment of Risk of Bias Assessment (RoB) of 75-100% of low risk and less than 25% rating of “some concerns,” most information across the journals were sufficiently low-risk bias. Despite some incomplete information, it is unlikely that this would affect the synthesized results.



Figure 2. Traffic Light plot and summary plot of the risk of bias assessment.

3.3 Spawn Run

Subbiah and Balan (2015) states that *C. indica*'s spawn run usually appears at 15 to 20 days while *P. ostreatus*' 2 to 3 weeks (Buah et al., 2010). In Table 2, it was observed that the reviewed journals followed these values with slightly larger ranges (*C. indica* - 15.00 to 23.20 days, *P. ostreatus* - 13.81 to 29 days).

Two substrates are tied as a preferred substrate for *C. indica*: paddy and wheat straw. Patel and Trivedi (2016) and Shrikhandia and Sumbali (2019) had paddy straw as their best substrate, while for Singh et al. (2019) and Vijaykumar et al. (2013), it was wheat straw. Similarly, wheat straw was also a suitable performing substrate for *P. ostreatus*, followed by sugarcane bagasse. Spawn run was significantly higher than other substrates in two studies (Abid et al., 2020; Yang et al., 2013).

Table 2. Mean spawn run (days) of *C. indica* across different studies

Substrate	Patel & Trivedi (2016)	Singh et al. (2019)	Vijaykumar et al. (2014)	Navathe et al. (2014)	Shrikhandia and Sumbali (2019)
Paddy straw	18.4	-	17.67	17	15.00
Wheat straw	20.2	18.44	15.67	-	15.93
Sugarcane bagasse	21.4	23.20	19.00	-	-

Table 3. Mean spawn run (days) of *P. ostreatus* across different studies

Substrate	Abid et al. (2020)	Zakil et al. (2020)	Zakil et al. (2019)	Sitaula et al. (2018)	Yang et al. (2013)
Paddy straw	25.83	-	-	18.25	-
Wheat straw	19.50	-	-	-	13.81
Sugarcane bagasse	-	29	26	20.00	-

3.4 Pinhead formation

The first growth milestone to a fruiting body, pinhead formation, signifies a mushroom's health (Ibrahim et al., 2017). For *C. indica*, it takes 10 to 28.67 days to form (Subbiah & Balan, 2015; Kumar et al., 2017). Similarly, *P. ostreatus* takes 16 to 27 days to develop pinheads (Buah et al., 2010).



Figure 3. Spawn Run (a), Pinhead Formation (b), and Pinhead Formation to Maturation (c) of *P. ostreatus* from Tesfay et al. (2020)



Figure 4. Spawn Run (a), Pinhead Formation (b), and Cropping Stage (c) of *P. ostreatus* from Kora (2020)

In Table 4, Shrikhandia and Sumbali (2019) and Navathe et al. (2014) had the paddy straw develop the fastest pinheads. Contrariwise, Singh et al. (2019) and Vijaykumar et al. (2014) had wheat straw as the best substrate. Note that in Singh et al. (2019), paddy straw was not able to cultivate mushrooms. *P. ostreatus*' best substrate for pinhead formation was identical to its spawn run: wheat straw. Occurring in two literature works (Yang et al., 2013; Abid et al., 2020), it was the fastest pinhead formation across journals. Following these values was sugarcane bagasse for *C. indica* and paddy straw for *P. ostreatus*. It is evident among both mushrooms that wheat straw is the most efficient for pinhead formation.

Table 4. Pinhead formation(days) of *C. indica* across different studies

Substrate	Patel & Trivedi (2016)	Singh et al. (2019)	Vijaykumar et al. (2014)	Navathe et al. (2014)	Shrikhandia and Sumbali (2019)
Paddy straw	405	-	1324	810.5	399.03
Wheat straw	298	320.04	1463	-	388.61
Sugarcane bagasse	255	221.8	515.7	-	-

Table 5. Pinhead formation(days) of *P. ostreatus* across different studies

Substrate	Patel & Trivedi (2016)	Singh et al. (2019)	Vijaykumar et al. (2014)	Navathe et al. (2014)	Shrikhandia and Sumbali (2019)
Paddy straw	18.66	-	-	21.75	-
Wheat straw	16.50	-	-	-	6.00
Sugarcane bagasse	-	30	28	23.25	-

3.5 Total yield

Despite the incomplete information, paddy straw was revealed to be a dominant substrate in terms of the average yield in the *C. indica*. Three out of five studies concluded this with wheat straw as the second-best substrate. Consequently, Vijaykumar et al. (2014) and Singh et al. (2019) had wheat as their preferred substrate with paddy straw following these values.

Studies on *P. ostreatus* show that wheat straw has a more significant influence than paddy straw in the mushroom's growth. This was supported by Abid et al. (2019) and Yang et al. (2013), with their total yield was highest on paddy straw. This was closely followed by paddy straw. Although sugarcane bagasse had a significantly high value in Sitaula et al.'s (2018) work, overall, it still had relatively lower values.

Table 6. Total yield (grams) of *C. indica* across different studies

Substrate	Patel & Trivedi (2016)	Singh et al. (2019)	Vijaykumar et al. (2014)	Navathe et al. (2014)	Shrikhandia and Sumbali (2019)
Paddy straw	405	-	1324	810.5	399.03
Wheat straw	298	320.04	1463	-	388.61
Sugarcane bagasse	255	221.8	515.7	-	-

Table 7. Total yield (grams) of *P. ostreatus* across different studies

Substrate	Abid et al. (2020)	Zakil et al. (2020)	Zakil et al. (2019)	Sitaula et al. (2018)	Yang et al. (2013)
Paddy straw	145.33	-	-	528.45	287.2
Wheat straw	160.5	-	-	-	287.43
Sugarcane bagasse	-	41.35	273.3	527.8	-

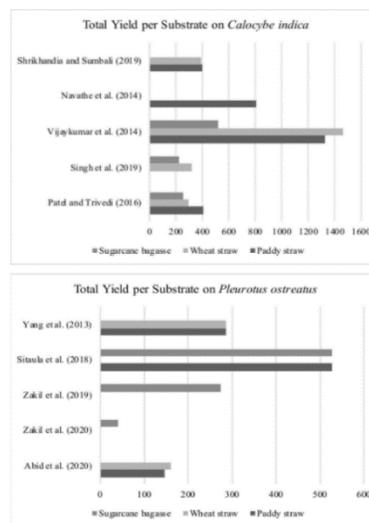

Figure 5. Total yield (grams) of *C. indica* (top) and *P. ostreatus* (bottom) across various studies

3.6 Biological Efficiency

Biological efficiency is the amount of yield per kilogram of substrate. Similar to the yield, paddy straw outperforms other substrates on the biological efficiency of *C. indica*. With a range of 77.6% to 134.86%, paddy straw is the best substrate in three out of four journals, excluding the studies that did not assess it. Having more divided views, among *P. ostreatus* studies, paddy has the overall highest biological efficiency in Sitaula et al. (2018) and Yang et al. (2013). In contrast, wheat straw was favored in Singh et al. (2019), followed by paddy straw. It can be said that paddy and wheat straw have a slightly similar performance.



Table 8. Biological Efficiency (Percentage) of *C. indica* across different studies

Substrate	Abid et al. (2020)	Zakil et al. (2020)	Zakil et al. (2019)	Sitaula et al. (2018)	Yang et al. (2013)
Paddy straw	24.38	-	-	78.33	78.73
Wheat straw	22.6	-	-	-	78.35
Sugarcane bagasse	-	44.95	68.33	71.91	-

Table 9. Biological Efficiency (Percentage) of *P. ostreatus* across different studies

Substrate	Patel & Trivedi (2016)	Singh et al. (2019)	Vijaykumar et al. (2014)	Navathe et al. (2014)	Shrikhandia and Sumbali (2019)
Paddy straw	134.86	-	132.4	81.05	79.8
Wheat straw	85.07	64	146.3	-	77.6
Sugarcane bagasse	85.02	44.36	51.57	-	-

in early primordial formation.

Additionally, Amin et al. (2010) expressed that cellulose-rich substrates are also responsible for higher yield. With a relatively higher cellulose content than sugarcane bagasse, wheat and paddy straw initiated high yield performance in *P. ostreatus* and *C. indica*. Lastly, paddy straw has the second-highest C/N ratio and highest cellulose content. It outperformed the other two substrates in yield parameters but had equal performance in growth parameters to wheat straw. This could be due to the abundance of both the C/N ratio and cellulose content.

Table 10. Composition of substrates (Ahmed et al., 2011; Bakker et al. 2013; Ferreira et al., 2016; Lindsley et al., 2017; Sakdaronarong et al., 2012; Sharma et al., 2014)

Substrate	C/N ratio	Cellulose (%)	Hemicellulose
Paddy straw	90:1	37.5	30
Wheat straw	80:1	33.5	25
Sugarcane bagasse	100:1	33	24

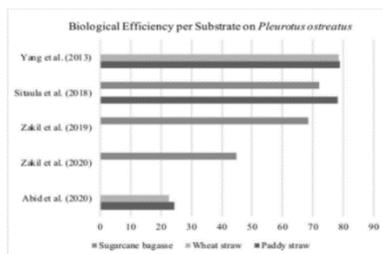
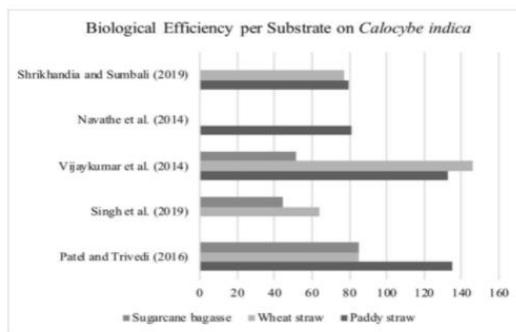

Figure 6. Biological Efficiency (Percentage) of *C. indica* (top) and *P. ostreatus* (bottom) across different studies

3.7 Effect of the composition of substrates

It is speculated that the composition of the substrates affected the growth and yield of the mushroom. Ahmed et al. (2009) and Elahe et al. (2016) reported that the right amount of hemicellulose, cellulose, lignin, and the carbon-nitrogen (C/N) ratio is accountable for quick spawn run. Hoa et al. (2015) also stated that an adequate amount of C/N ratio is desired for mycelium growth. However, a lower ratio is better for the creation of primordia that develop into fruiting bodies. Wheat straw has the lowest C/N ratio out of all the chosen substrates as seen in Table 10. Hence, the contents of wheat straw fulfill the nutritional demand of both mushrooms, which results

4. CONCLUSIONS

The studies reviewed sufficiently provided detailed information that indicated wheat straw seemed to outdo the other substrates on spawn run and pinhead formation for both *C. indica* and *P. ostreatus*. Simultaneously, paddy straw excelled on total yield and biological efficiency for both mushrooms. To some extent, this suggests that both wheat straw and paddy straw as substrates may be acceptable for use in specific parameters by farmers and producers, depending on the targeted parameter that needs concentration. No evidence supported which substrate outdid all other substrates alone, considering both parameters and mushrooms. Instead, the results from studies situated in Asian countries similar to the Philippines' climate suggested that the application of wheat straw and paddy straw substrates is worth investing in to attain more efficient production. Results provided limited coverage of the influences the substrates have from various set-ups and environmental effects. This emitted implications on the validity of mushroom cultivation evaluations.

5. ACKNOWLEDGMENTS

We, the researchers, would first like to thank our research adviser, Ms. Leah Madrazo, of the Senior High School Department at De La Salle University Laguna Campus. She was always one chat away whenever we had trouble or needed guidance. Without her passionate participation and cooperation, the research could not have been successfully conducted. Finally, we must express our sincere gratitude to our family and friends for providing us with unwavering



support and continuous encouragement throughout the process of this research. Thank you.

6. REFERENCES

- Abid, A., Hamid, A., Naz, R., Shah, S., Anjum, S., Khan, M., & Ilyas, M. (2020). Impact of different lignocellulose substrates on growth and yield of oyster mushroom (*Pleurotus ostreatus*). *Pure and Applied Biology*, 9(1), 768-775. <https://doi.org/19045/bspab.2020.90083>
- Ahmed, I., Zia, M. A., Iftikhar, T., & Iqbal, H. M. (2011). Characterization and detergent compatibility of purified protease produced from *Aspergillus niger* by utilizing agro wastes. *BioResources*, 6(4), 4505-4522.
- Ahmed S.A., Kadam, J.A., Mane, V.P., & Baig M.M. (2009). Biological efficiency and Nutritional contents of *Pleurotus florida* cultivated in different agro Wastes. *Nat. Sci*, 7(1), 45-48.
- Amin, R., Khair, A., Alam, N., & Lee, T. S. (2010). Effect of Different Substrates and Casing Materials on the Growth and Yield of *Calocybe indica*. *Mycobiology*, 38(2), 97-101. <https://doi.org/10.4489/MYCO.2010.38.2.097>
- Bakker, R. R. C., Elbersen, H. W., Poppens, R. P., & Lesschen, J. P. (2013). Rice straw and wheat straw-potential feedstocks for the biobased economy. NL Agency. <https://english.rvo.nl/sites/default/files/2013/12/Straw%20report%20AgNL%20June%202013.pdf>
- Belletini, M., Fiorda, F., Maieves, H., Teixeira, G., Ávila, S., Hornung, P., Júnior, A., & Ribani, R. (2019). Factors affecting mushroom *Pleurotus* spp. *Saudi Journal of Biological Sciences*, 26(4), 633-646. <https://doi.org/10.1016/j.sjbs.2016.12.005>
- Buah, J. N., Van der Puije, G. C., Bediako, E. A., Abole, E. A., & Showemimo, F. (2010). The growth and yield performance of oyster mushroom (*Pleurotus ostreatus*) on different substrates. *Biotechnology*, 9(3), 338-342. <https://doi.org/10.3923/biotech.2010.338.342>
- Elahe K.J., Mehrdad, J., & Shahin, E. (2016). King oyster mushroom production using various sources of agricultural wastes in Iran. *International J Rec Org Waste Agr*, 5, 17-24. <https://doi.org/10.1007/s40093-015-0113-3>
- Ferreira, D. A., Franco, H. C., Otto, R., Vitti, A. C., Fortes, C., Faroni, C. E., ... & Trivelin, P. C. (2016). Contribution of N from green harvest residues for sugarcane nutrition in Brazil. *Gcb Bioenergy*, 8(5), 859-866. <https://doi.org/10.1111/gcbb.12292>
- Hoar, H. T., Wang, C. L., & Wang, C. H. (2015). The Effects of Different Substrates on the Growth, Yield, and Nutritional Composition of Two Oyster Mushrooms (*Pleurotus ostreatus* and *Pleurotus cystidiosus*). *Mycobiology*, 43(4), 423-434. <https://doi.org/10.5941/MYCO.2015.43.4.423>
- Ibrahim, R., Jamil, A. A. I. M., Hasan, S. M. Z., Arshad, A. M., & Zakaria, Z. (2017). Enhancing Growth and Yield of Grey Oyster Mushroom (*Pleurotus sajorcaju*) Using Different Acoustic Sound Treatments. *MATEC Web of Conferences*, 97, 1054. <https://doi.org/10.1051/mateconf/20179701054>
- Kora, A. J. (2020). Nutritional and antioxidant significance of selenium-enriched mushrooms. *Bulletin of the National Research Centre*, 44(1), 1-9. <https://doi.org/10.1186/s42269-020-00289-w>
- Kumar, R., Singh, G., Mishra, P., & Singh, R. (2012). Effect of different organic supplements and casing mixtures on yield of two strains of milky mushroom (*Calocybe indica*). *Indian Phytopathol*, 65, 399-403.
- Lindsley, L., & Lentz, E. (2017). Nutrient value of wheat straw. Ohio State University Extension. <https://agcrops.osu.edu/newsletter/corn-newsletter/nutrient-value-wheat-straw#:~:text=The%20USDA%20reports%20a%20C,mineralization%20will%20be%20much%20lower>
- National Horticulture Board. (n.d.). OYSTER MUSHROOM http://nhb.gov.in/report_files/oyster_mushroom/oyster%20mushroom.htm
- Navathe, S., Borkar, P., & Kadam, J.J. (2014). Cultivation of *Calocybe indica* (P & C) in Konkan Region of Maharashtra, India. *World Journal of Agricultural Research*, 2, 187-191.
- Rahi, D., & Malik, D. (2016). Diversity of Mushrooms and Their Metabolites of Nutraceutical and Therapeutic Significance. *Journal of Mycology*, 2016. <https://doi.org/10.1155/2016/7654123>



- Sakdaronnarong, C., & Jonglertjunya, W. (2012). Rice straw and sugarcane bagasse degradation mimicking lignocellulose decay in nature: An alternative approach to biorefinery. *ScienceAsia*, 38(4), 364-372. <https://doi.org/10.2306/scienceasia1513-1874.2012.38.364>
- Samonte, P. (2014). Milky mushroom now produced commercially. *Monthly Agriculture*. <https://www.agriculture.com.ph/2018/03/22/milky-mushroom-now-produced-commercially/>
- Sbhatu, D., Abraha, H., & Fisseha, H. (2019). Grey Oyster Mushroom Biofarm for Small-Scale Entrepreneurship. *Advances in Agriculture*, 2019. <https://doi.org/10.1155/2019/6853627>
- Sharma, A., Sharma, R., Arora, A., Shah, R., Singh, A., Pranaw, K., & Nain, L. (2014). Insights into rapid composting of paddy straw augmented with efficient microorganism consortium. *International Journal of Recycling of Organic Waste in Agriculture*, 3(2), 54.
- Singh, V., Baghel, D., Shukla, C.S., and Singh, H.K. (2019). Role of Different Substrates and Organic Supplements on Growth and Yield of Different Strains of *Calocybe indica*. *International Journal of Current Microbiology and Applied Sciences*, 8(11), 2263-2269. <https://doi.org/10.20546/ijcmas.2019.811.263>
- Sिताला, H. P., Dhakal, R., Geetesh, D., & Kalauni, D. (2018). Effect of Various Substrates on Growth and Yield Performance of Oyster Mushroom (*Pleurotus ostreatus*) in Chitwan, Nepal. *International Journal of Applied Sciences and Biotechnology*, 6, 215. <https://doi.org/10.3126/ijasbt.v6i3.20859>
- Spowart, R. (2017). The story of milky mushroom. *Monthly Agriculture*. <https://www.agriculture.com.ph/2017/10/09/the-story-of-milky-mushroom/>
- Subbaiah, K., & Balan, V. (2015). A Comprehensive Review of Tropical Milky White Mushroom (*Calocybe indica* P & C). *Mycobiology*, 43(3), 184-194. <https://doi.org/10.5941/MYCO.2015.43.3.184>
- Sumbali, G., & Shrikhandia, P. (2019). Studies on the evaluation of some strains of *Calocybe indica* P&C for cultivation in Jammu. *International Journal of Research in Pharmaceutical Sciences*, 10(3), 2457-2465. <https://doi.org/10.26452/ijrps.v10i3.1494>
- Tesfay, T., Godifey, T., Mesfin, R., & Kalayu, G. (2020). Evaluation of waste paper for cultivation of oyster mushroom (*Pleurotus ostreatus*) with some added supplementary materials. *AMB Express*, 10(1), 1-8. <https://doi.org/10.1186/s13568-020-0945-8>
- Trivedi, R., & Patel, P. (2016). Yield Performance of *Calocybe indica* on Different Agricultural Substrate. *International Research Journal of Engineering, IT and Scientific Research*, 2, 105-111.
- Vijaykumar, G., John, P., & Ganesh, K. (2014). Selection of different substrates for the cultivation of milky mushroom (*Calocybe indica* P & C). *Indian Journal of Traditional Knowledge*, 13, 434-436.
- Yang, W., Guo, F., & Wan, Z. (2013). Yield and size of oyster mushroom grown on rice/wheat straw basal substrate supplemented with cotton seed hull. *Saudi journal of biological sciences*, 20(4), 333-338. <https://doi.org/10.1016/j.sjbs.2013.02.006>
- Zakil, F., Hassan, K., Mohd, S., Mohd, S., & Isha, R. (2020). Growth and yield of *Pleurotus ostreatus* using sugarcane bagasse as an alternative substrate in Malaysia. *IOP Conference Series: Materials Science and Engineering*. 736. 022021. <https://doi.org/10.1088/1757-899X/736/2/022021>
- Zakil, F.A., Sueb, M.S., & Isha, R. (2019). Growth and yield performance of *Pleurotus ostreatus* on various agro-industrial wastes in Malaysia. *AIP Conference Proceedings*, 2155(1). <https://doi.org/10.1063/1.5125559>



Willful Ignorance, Self-Deception, and the Motivation Condition– A Reply to M. Glowicki (2018)

Janne Raquel P. Matubis
De La Salle University Integrated School, Manila

Abstract: Despite being given significant attention in the philosophical literature, the account of willful ignorance is still constantly debated upon. Philosophers such as Glowicki (2018) have debated that the inconvenience of knowing the proposition is not necessary for one to be willfully ignorant because of the instances of ‘praiseworthy willful ignorance’ that he proposes. In this article, I will argue that while this is true, her account is insufficient as though it need not be inconvenient, one must still have a motive to remain willfully ignorant of the proposition. With this, I will explain the importance of the motivation condition in the account of willful ignorance and how its necessity disproves Glowicki’s (2018) claim that there is a close relationship between willful ignorance and self-deception.

Key Words: epistemology; willful ignorance; praiseworthy willful ignorance; self-deception; motivation condition

1. INTRODUCTION

Consider this case of Glowicki (2018, p. 3-4). A parent receives an email from their child’s school regarding an influx of new students who are *deathly* allergic to peanuts. The parent glances at the email and perceives it as ‘spam’ and moves it to the trash folder. In the same week, the parent, later on, received a voicemail this time from the school saying that it concerns *all* students and is especially sensitive as it concerns students with allergies attending the school. The parent then clicks ‘next’ as they rationalize that ‘My kid doesn’t have allergies, so this voicemail doesn’t concern me.’ A month later, the parent receives a flyer from the school reading “Health Awareness: Parents, Please Read”. The parent then immediately throws the flyer, thinking, ‘Gosh! The precautions these schools have to take nowadays.’

The case mentioned presents a kind of ignorance that some philosophers refer to as “willful ignorance”. Willful Ignorance, in its broadest sense, may be defined as “ignorance that is due to one’s own will rather than to external barriers” (Wieland, 2016, p. 2).

Despite the significant attention given to the concept of ‘willful ignorance’, the necessary conditions of what makes a person willfully ignorant are still a blur. Glowicki (2018) had recently taken up this debate claiming that a doxastic attitude of suspicion is unnecessary in opposition to Lynch (2016), and she diverged from the feature that Wieland (2016) and Lynch (2016) both hold, which is ‘knowing p is inconvenient.’ With that, she creates an account of willful ignorance that proves the relation of willful ignorance and self-deception.

Though in my paper, I shall be arguing that a

motivation condition is necessary for willful ignorance when determining whether one is willfully ignorant. With this, I will be arguing that Glowicki’s (2018) account is too broad as it accounts for indifferent, stupid, apathetic, and with lack of curiosity subjects. Furthermore, I aim to prove that indifferent, stupid, or apathetic subjects and the like are not willfully ignorant, deeming Glowicki’s account as insufficient, and propose a more revised account focusing on the necessity of a motivation condition to suffice for that shortcoming. This account will then be used to disprove the relation of willful ignorance and self-deception.

2. Necessary Conditions of Willful Ignorance

A recent account by Madeline Glowicki (2018, p. 3) holds ‘suspicion’ being an unnecessary condition for willful ignorance, although Glowicki diverges on the clause that ‘ p is inconvenient for S ’. Glowicki argues for this by proposing an account of praiseworthy willful ignorance that oftentimes does not adhere to the inconvenience clause. Glowicki (2018, p. 5) states, “In instances of praiseworthy willful ignorance, S does not choose to remain ignorant because it is convenient to do so but because, for example, they believe it’s the right thing to do.”

Firstly, I agree with Glowicki (2018) that a condition of suspicion is not necessary. One may be willfully ignorant without suspecting p to be the case. What I argue matters here is, at the very least, S is aware and knows that p may be the case. Secondly, I agree with Glowicki (2018) that an inconvenience clause does not matter. In cases of praiseworthy willful ignorance, one may be willfully ignorant of p



not because knowledge of p is inconvenient for them, but because they think it is the right thing to do. While this is true, where I diverge from Glowicki's (2018) account is wherein S may or may not consider p to be normatively relevant as Glowicki claims. I diverge from this point because willful ignorance does not hold cases wherein the subject does not consider the proposition p to be normatively relevant. I will argue that S must have a motivation, and there is a need of a motive prong of wanting to *not* know p in order to be considered willfully ignorant so that it may not account for people who are lazy, apathetic, disinterested, and the like, towards knowing p , for if they are, then their ignorance is not exactly willful. I shall explain this further in the next sections of my paper.

3. Willful Ignorance and its relation to Self-Deception

Glowicki argues that knowing p need not be inconvenient for the subject because this only applies to instances of blameworthy willful ignorance. With this, Glowicki (2018, p. 5) holds the following account:

- i. S knows that proposition p might be the case;
- ii. proposition p is available;
- iii. knowledge of proposition p is normatively relevant;
- iv. S decides they wish to remain ignorant of proposition p , for some reason R ;
- v. S takes the appropriate steps, and is successful, in remaining ignorant of proposition p .

Glowicki claims that in some instances of willful ignorance, self-deception is involved. She argues that "blameworthy willful ignorance always involves some self-deception on the part of S , because S will always be self-deceptive concerning the normative relevance of p while praiseworthy willful ignorance never involves self-deception concerning the normative relevance of p " (2018, p. 20). She further explains this by utilizing two features found in paradigmatic cases of self-deception which are (2018, p. 21):

1. The subject encounters evidence indicating that some true proposition, p , is normatively relevant.
2. They strongly desire that p is not normatively relevant (i.e., normatively irrelevant).

Glowicki claims that in cases of blameworthy willful ignorance, the subject S exhibits behavior identical to self-deceived subjects wherein the subject S either encounters or knows that p is normatively relevant, yet they decide not to investigate on it

further as they falsely believe that p is not normatively relevant and does not concern them when it actually does.

4. Necessity of a Motivation Condition

I disagree with Glowicki's account because such an account is what I argue is insufficient and unclear. I claim that a condition of motivation is necessary in deducing whether one is willfully ignorant for if there is no motive prong, then lazy, apathetic, and disinterested people would be considered willfully ignorant, and because they are *not* willfully ignorant, there should be no absence of a motive prong. I will be proving this through the evidence that in willful ignorance, one must avoid knowledge of p , if one *is* fine with knowing p , then they are not willfully ignorant at all. Secondly, willful ignorance is about the deliberation of sustaining their ignorance, if the subject does not even consider themselves as ignorant, then they are not willfully ignorant at all.

These two characteristics are what I will argue that lazy, disinterested, and apathetic people may hold that contradicts their willful ignorance, (1) they are fine with knowing p , and (2) they oftentimes do not consider themselves as ignorant. Furthermore, if a subject *is* willfully ignorant, this entails that they wish to remain ignorant of the proposition. If they wish to remain ignorant of a proposition, then it means they do *not* want to know the proposition. So if a subject is willfully ignorant, then they must *not* want to know the proposition.

Let us take this example wherein the subject is apathetic towards knowing p . Suppose Frank has been a loyal buyer to a certain toothpaste brand. Later that year, Frank's mother found out that the toothpaste company has their products made in very detrimental slavery-like conditions. She read an article with the headline "Top Global Toothpaste Company Masks Unethical Labour Conditions". She sends this email to her son, Frank in hopes that he will stop buying from the company. Frank reads the headline of the email and assumes that the toothpaste company has unethical conditions, but something in the degree of contractualization of workers and not something as harsh as literal slavery-like conditions. Not long after, Frank, thinking he has something else better to do, does not read the article further and puts it in the trash folder. Frank's mother, not having received a reply, then emails him the same article every week, thinking that he has not read it, and Frank continues to ignore what is in the email simply because he is uninterested, thinking he has something else better to do. Though suppose his mother calls him on a weekend and decides to explain to him the contents of the article through call, and he chooses not to hang up because he has some time on his hands. He



then finds out about the truths of the toothpaste company without any remorse or inconvenience from finally knowing p .

It can be said that this case fulfills all the necessary conditions of Glowicki's account. It is also clear that Frank here chooses not to know p for whatever reason that he had, but what is not clear is whether his intentions of becoming ignorant was, in fact, *willful*. In respect to Glowicki's account, he would already be considered as someone 'willfully ignorant', but we cannot exactly say that Frank's ignorance *was* intended as (1) he did not mind finding out that p later on, and (2) he thinks that he already knows enough about p that makes him think it is unnecessary for him to find out more.

4.1 Attitude towards the proposition

Willful ignorance is about avoiding knowing a certain proposition; hence this avoidance of a fact or truth makes one as *willfully* ignorant. Though if a subject is fine with knowing p , then willful ignorance is not the case. One cannot be fine or open to knowing about the proposition and still be considered willfully ignorant for avoiding knowledge of it because then, it is not their ignorance they are being *willful* of, but then some other reason that is definitely not to sustain their ignorance. Let us take the example of Frank. What we can clearly infer from his situation is that he simply wanted to avoid wasting time. If anything, the only willfulness he has exhibited is his willfulness in making productive use of his time and not in sustaining his ignorance. To me, it seems counterintuitive to consider Frank as 'willfully ignorant' as per Glowicki's account, especially when this has not been his intention. Furthermore, if a subject is fine with knowing p , then we cannot exactly consider their actions as avoidance of knowing p , which willful ignorance is supposedly all about.

4.2 Awareness of the subject's ignorance

Glowicki agrees that one may be fully aware that they are willfully ignorant but the insufficiency in his account leaves a hole for subjects who do not even consider themselves as willfully ignorant. In Glowicki's account, Frank may already be considered as one who is willfully ignorant, but if asked if he was being willfully ignorant, it is possible that he would not say he is fully ignorant, for he already knows that the company has unethical labor conditions, and he thought to himself that is all that he needs to know to not buy from them. Though if a subject would not consider themselves as fully willfully ignorant, then it is wrong for us to even consider them as willfully ignorant at all. Willful ignorance is about one's decision to sustain their ignorance, but if they think that they are not so ignorant at all, then their action cannot be justified as to be exactly avoiding knowledge

of p .

This then creates a conflict within Glowicki's account as there is room for people to 'willfully avoid' p , as per Glowicki, yet at the same time have subjects who would not admit they are willfully ignorant. This attitude of the subject towards their ignorance undermines the whole willfulness of the action, hence making Glowicki's account insufficient.

I argue that it is very counterproductive to exclude one's intentions in determining whether one is willfully ignorant because this undermines the whole 'willfulness' in the action.

5. An Account of Willful Ignorance

Having explained the importance of the motivation condition in fulfilling this hole of determining one's willful ignorance, I suggest that the account of willful ignorance must be as follows:

- i. p is true;
- ii. p is readily available, and finding out p would not be exorbitantly demanding for S ;
- iii. S knows that p might be the case;
- iv. p is normatively relevant;
- v. S does an action u knowing that it keeps him ignorant of p ;
- vi. because S does *not* want to know p .

It is not enough that the subject subconsciously knows it keeps them ignorant, especially if it is not their intention to be. Furthermore, identifying one's motivation clears the whole purpose of the act. And as for the case of the parent, what can be inferred here is not exactly the parent 'wishing to sustain their ignorance of p ', but rather wishing to 'not waste valuable time'. This then undermines the *willfulness* to be ignorant in the situation as the parent does not deliberately try to sustain their ignorance, but they deliberately *try* not to waste time, having ignored the email only as a byproduct of that motivation. So, in this case, on my account, I would not call the parent willfully ignorant as motivation plays an important role in determining one's willfulness in their ignorance.

Now whether this could be closely linked to self-deception as Glowicki (2018) claims wherein in instances of blameworthy willful ignorance, S will always be self-deceptive concerning the normative relevance of p , I argue that these two are very distinct for the reason that if the subject considers p to be normatively irrelevant, then they would be indifferent towards knowing p or would lack the curiosity to do so, making no willful ignorance involved but merely self-deception. So on my account, it is impossible for one to consider p as normatively irrelevant and still be willfully ignorant.



2. CONCLUSIONS

I have proven that if there is no motivation clause in Glowicki's account, then people who are lazy, apathetic, or disinterested may be considered as willfully ignorant. I had also proven that lazy, apathetic, or disinterested subjects may not be considered willfully ignorant because they are fine with knowing p , and they may not consider themselves willfully ignorant, which would then be contradictory in Glowicki's account.

I had argued that it is impossible that S does not consider p as normatively irrelevant and simultaneously have the motivation to *not* want to know p while being self-deceived, for if S had been self-deceived into thinking p is normatively irrelevant, then their efforts to avoid p is not so that may continue to be ignorant of it, but simply because of other reasons such as they would not want to waste time or such, undermining their willfulness to be ignorant. Also, if S had been self-deceived of the normative relevance of p , then it is impossible for them to *not* want to know p , for if they do, then it is because they believe p indeed may be true and that it is normally relevant after all for them to *not* want to know it.

3. ACKNOWLEDGMENTS

The author would like to thank their research adviser, Dr. Mark Anthony Dacela, for the continual motivation in pursuing this study. His continual guidance has helped the author continue to persevere for the success of this paper. It is him who has helped the author strengthen their bond with philosophy. This all wouldn't be possible without him.

4. REFERENCES

- Bailey, A. (2007). Strategic Ignorance. *Race and Epistemologies of Ignorance*, 77-86.
- Glowicki, M. (2018). An Account of Willful Ignorance: Blameworthy Willful Ignorance, Praiseworthy Willful Ignorance, and Self-Deception.
- Husak, D. (2010). Willful Ignorance, Knowledge, and the 'Equal Culpability' Thesis: A Study of the Deeper Significance of the Principle of Legality. *The Philosophy of Criminal Law: Selected Essays*, 200-232.
- Lynch, K. (2016). Willful ignorance and self-deception. *Philosophical Studies*, 173(2), 505-523.
- Moody-Adams, M. (1994). Culture, responsibility, and affected ignorance. *Ethics*, 104(2), 291-309.

Sarch, A. (2014). Willful Ignorance, Culpability and the Criminal Law. *St. John's Law Review*, 8(1), 1023-1102

Sarch, A. (2018). Willful ignorance in law and morality. *Philosophy Compass*, 13(5), e12490. doi:10.1111/phc3.12490

Tuana, N. (2006). The speculum of ignorance: the women's health movement and epistemologies of ignorance. *Hypatia*, 21(3), 1-19.

Wieland, J. W. (2017). Willful ignorance. *Ethical Theory and Moral Practice*, 20(1), 105-119.

Zimmerman, M. J. (2020). Willful Ignorance and Moral Responsibility. *Oxford Studies in*

Normative Ethics, 10(1), 56-80. doi:10.1093/oso/9780198867944.003.0004



An Ethical Inquiry to Personhood as the Standard for Sexbot Ownership: A Response to S. Petersen

John Andrei E. Esguerra, Daniel Christopher L. Haduca,
and Jeulian Clarisse C. Manalo
De La Salle University Integrated School, Manila

Abstract: In the field of robot ethics, debates about sexbots, their personhood, and their moral status continue. To provide our stance in this debate, we ask the question: Is it unethical for sexbots to be owned? This paper responds to the claims of Steve Petersen's (2016) paper "Is it good for them too? Ethical concerns for the sexbots", where he argues that sexbots are not wronged for performing the functions they are designed for. We respond to this claim by arguing for John Danaher's Theory of Ethical Behaviorism (2020). If ethical behaviorism is correct in claiming that behavior is a sufficient ground for moral status ascription, we see sexbot ownership as unethical. We argue for our claim and show that the moral considerability of the sexbot could be proven under the standards given in our framework for ascribing moral status.

Key Words: ethics; robot ethics; robot servitude; sexbots; ethical behaviorism

1. INTRODUCTION

The growing prominence of artificial intelligence usage in media and technology has enabled a debate in robot ethics to persist. Starting from Turing's Turing Test (1950) to the Chinese room experiment (Searle, 1980), there has been growing interest to unravel the moral and ethical implications of the trend for both users and the machines (Headland, C.K., Teahan, W. J., & Cenydd, L., 2019).

This paper is a response to Petersen's 2016 paper which argues that sexbots are not being wronged by the virtue of their function. However, insofar granting sexbots their ethical significance by assuming their personhood, Petersen's arguments on "wronging" the sexbot were reliant on the sexbot's design. In this paper, we argue that assessing what wrongs the sexbot should be due to the ethical significance we grant them, in this case, personhood. First, we will establish that sexbots are persons following the framework of John Danaher's Ethical Behaviorism (2019). This framework suggests that it is permissible to grant moral consideration to entity X, an entity with no moral status, as long as it displays rough performative equivalence to entity Y, an entity with moral status. In effectively establishing that sexbots are persons, we disprove Petersen's arguments and conclude that sexbots may be wronged by virtue of their function, especially if it entails being owned.

2. A Review on Petersen's Arguments

In his 2016 paper "Is it good for them too? Ethical concerns for the sexbot", Petersen inquires whether sexbots are being wronged by virtue of their

function as a sexbot. He claims that sexbots are not being wronged by analyzing them under four assumed causes of how we may wrong the sexbot. Petersen (2016) also characterized sexbots as: (1) as ethically valuable & intelligent as humans; (2) sexbots can stimulate real pleasure; and (3) sexbots are persons.

The first asks whether we are wronging the sexbot when we design sex as a necessary pleasurable activity for them. Petersen (2016) claims we do not since sexbots do not have existing pleasures prior to their creation. Here, we agree with Petersen's implications of denying his claim, because if sexbots are wronged by their design for sex, then they can be wronged by any design which will not make their creation entirely possible.

The second asks whether fixing sex sexbots desires wrong them because they do not have access to other pleasures necessary for well-being. Petersen (2016) argues that if sexbots are specifically designed to find sex as the only necessary desire, then it sufficiently satisfies its well-being. We grant here that assessing their well-being according to design does not bear ethical concern if not for the ethical significance we assume they have. Since it is innate for a person to pursue other activities than sex for well-being, we will establish that Petersen's claim is wrong and that his concept of sexbot personhood is not consistent with the moral consideration he gives them.

The third assumed cause asks whether the sexbots are wronged for what it's desiring since according to Mill & Aristotle, a good life must pursue higher intellectual pleasure. He claims that if we design sexbots to engage all of its higher faculties in sex, they will still live a good life. However, we reject



this claim since the inquiry of what is a “good” life for a sexbot should be due to their ethical significance as persons and not in their design.

The fourth assumed cause asks that regardless of whether the sexbots live a good life, they may still be wronged if they are enslaved and owned. Petersen argues that allowing sexbots to function for sex does not wrong their autonomy since it is within the constraints of its design. However, while we agree that they are not being wronged if they function within the constraints of their design, should they be given the ethical status of personhood, the fact that they are owned and enslaved already wrongs them.

However, Petersen already claimed that there is no need to compare human lives to sexbot lives, and perhaps he also meant their personhood. Not unless Petersen establishes a clear distinction between sexbot personhood and human personhood, the objection runs valid. The approach we will take in arguing against Petersen is by establishing that sexbots are persons. Proven of their personhood, only then can we question the wrongness we do to sexbots on their ethical significance. The way that this claim will be established is by operating John Danaher’s (2020) Theory on Ethical Behaviorism.

3. On John Danaher’s Ethical Behaviorism

John Danaher (2020) claims in his Theory of Ethical Behaviorism that the performative artifice of entity X (an entity with no moral status) that is similar to entity Y (an entity with moral status) is a sufficient ground for that entity to be granted the same moral status ascription, compared to the conventional approach in which we question an entity’s moral status based on its qualities. Since these qualities are also mostly metaphysical, ethical behaviorism claims that we can only have access to this by observing behavior. It does not disprove the standard approach but rather sees the epistemic limits we have on the metaphysical qualities. Finally, this implicates behavior as a sufficient ground in evaluating the moral significance of an entity.

This provides us space to argue for the moral considerability of sexbots—especially those who behave like humans—in a different light, in the instance that they are owned. In this paper, we will also tackle the standards with what rough performative equivalence to humans will the sexbots need to surpass in order to be granted the same moral consideration.

4. Standards of Unethicality for Sexbot Ownership

In its essence, our argument is as follows:

- P1. It is unethical for persons to be owned.
- P2. Sexbots are persons.
- C1. Therefore, it is unethical for sexbots to be owned.

The first premise, taken *prima facie*, inquires on what it is with persons that make owning them unethical, and we examine whether it can be applied to sexbot persons. The second premise, following ethical behaviorism, will be established by imposing the standards of the rough performative equivalence sexbots must pass in order to be granted the personhood status. We conclude that if sexbot personhood is established, then it would be impermissible to own sexbots. This draws back to our main claim that sexbots are persons, thus their ownership is morally impermissible

4.1. Why is it unethical for persons to be owned?

Persons are granted supreme moral and ethical significance because they constitute complex metaphysical qualities, such as intelligence, exercised meaningfully by autonomously pursuing its desires for himself and his well-being. This is the reason why respect is due to their moral worth as persons. Humans, as the only entities so far to have the status of personhood, constitute these metaphysical qualities, and therefore their moral rights are treated with supreme moral significance. This is because they are persons, not simply because they are humans. May (1976) argues that a human can only become a person once he becomes enculturated to the environment within which he trains all of his abilities to reach the complexity needed for personhood.

If what has been established is true, then the thrust of the following premise is coherent with this. Rather than examining the properties sexbots should have to qualify for moral significance, it might be correct to observe them the way they make themselves “meaningful persons.” This gives all the more reasons for us to accept ethical behaviorism as the framework for this argument.

4.2. Establishing that sexbots are persons

With the framework of ethical behaviorism overruling the argumentation, we are met with many dilemmas. While tempting to accept the theory first hand, we must ask first: what is the standard, and how are we going to determine whether a sexbot has enough characteristics to be considered an entity



deserving of moral status and patience? Danaher (2020) establishes that it is based on their rough performative equivalence, considering that ethical behaviorism argues performative artifice as sufficient to claim such moral status.

However, we acknowledge the speculations raised when establishing that of robot personhood. It is a common point of inquiry to question the standards set when establishing the robot as a person. We see the importance of this establishment, especially with the course of discussion and the issues surrounding robot ethics. More importantly, the problem becomes magnified when the robot in question is a sexbot, as it may so be compared to that of a human slave because of its utility and purpose.

We now come to a crucial part of our paper: the setting of standards as sufficient grounds for full moral status. As mentioned, there has been a rather lengthy discussion regarding this standard, as Petersen (2016) justified that sentience and intelligence are enough to grant it some kind of moral consideration. However, we fail to see this as an essential characteristic. With its purpose being to serve its human partner sexually, we see it fitting that one of the most critical standards one must consider when establishing robot personhood should instead be the robot's ability to engage in sexual acts.

Through this sole ground, we avoid many of the points that may be raised: On conscience, we avoid the issue of granting moral status to unconscious humans; On sentience and intelligence, we avoid the issue of moral status being granted to humans who are not sentient and are unintelligent. This goes by factual examples: the infant being that of the unconscious being and the animal being that of the unintelligent being, all still warranting themselves as beings with sufficient moral status, as a *prima facie* argument.

Thus, we reiterate Danaher's (2017) assertion: sex robots are indeed changing, and we must be prepared, as higher beings, to give them the considerability they deserve. These sexbots, rather these persons, are no other different than us beings exactly because their actions and our actions are one

4.3. The unethicity of owning sexbots

Jaworska, A., & Tannenbaum, J. (2013) established the idea of "incompletely realized sophisticated cognitive abilities" of robots as a standard for the personhood of robots. In that sense, they can improve and develop. Since the subjects do not comprehend the cognitively sophisticated activities at the moment, that does not mean they are void of personhood at the moment. This is compared to a child who is growing up or a dog who is being trained.

After all, sexbots are often modeled after

human beings, achieving hyperrealism within the competitive industry. These sexbots are also usually modeled to sell sex without any ethically implicating dilemmas, which means that the innovations made are to maximize profits. The manifestations of this are the aforementioned Turing Test. Since then, the lines have been blurred to the extent that we achieve a more realistic and pleasurable sexual partner. Therefore, their development, although made for profit, is development nonetheless. Our suggestion of personhood is consistent with the development of sexbots that Petersen supposes is a fact (Petersen 2016, p).

This consistency levels us in the framework that Petersen is operating upon, increasing the relevance of the analysis we are employing against his paper. The first and second premises have already proven the relevance of ethical behaviorism. It is logical to say that when the meaningfulness of one's personhood is removed, especially to an extent of mass-producing the person, they are at risk to have that meaningfulness further taken away. Moreover, since the development of sexbots will continue, it will also be increasing the likelihood of wronging the future, more sophisticated, and possibly more meaningful persons. Therefore, Petersen's case about performing "what they are purposed to do" is not consistent with the conclusion that sexbots can develop to be more sophisticated beings.

The relationship between human slavery and robot slavery asks now: what does it mean to remove a proportional amount of rights from the robot? It means eliminating these rights of a sexbot would also be parallel, to some extent, to that of removing the rights of humans. At least, what we mean by rights here are freedom and autonomy. This is clearly a concession that sexbots are not humans; however, sexbots deserve at the very least an extent of moral considerability to assess the most horrendous attack on personhood, slavery.

2. CONCLUSIONS

What has been established is a reply to Petersen's claims: there is no inherent wrong in designing sexbots and using them for their virtue. Here, we debunked the contradictions of his arguments especially upon acknowledging the future artificial capacities and ethical value of sexbots compared to humans, as well as concerning himself to caring whether the sexbots live a good life. If Ethical Behaviorism is correct, and it effectively establishes the sexbot's personhood, then it is wrong for the sexbot to be owned and to be used against its will to act—as future artificially sentient and intelligent beings—regardless if it is sexual or not since it violates what is contingent to its personhood; respect of its moral value.



On another note, perhaps it might be difficult to accept this argument because of anthropological biases. However, we need not run on this prejudice. We are living in a contemporary age where humans and technology interactively share one sphere. And by claiming this, we do not anthropomorphize non-human entities. Instead, we regard them as co-equal who extend one's capacities while utilizing the other.

3. ACKNOWLEDGMENTS

It is with immense gratitude that we acknowledge the support and help of our research adviser, Mark Anthony Dacela, whose work as a philosopher inspired us to conduct this study. With his father-like attitude and genius intuition, he guides and advises our direction and ideas as a team. With his expertise in Philosophy, we thank him most for his help and guidance in making a conclusive and cohesive philosophy thesis. Without his dedication and counsel, this paper would not have been possible. We would like to thank De La Salle University - Senior High School Manila for creating and holding a conducive learning environment and equipping us with resources to explore and research our ideas to corroborate with others. Their staff and faculty who have been cooperative with us through the makings of our study, for being considerate of the quality of our learning and research through these trying times, and completely supporting their students and giving them quality over results.

We are deeply grateful for our God and Country, our faith, service, and communion, all for their name and glory. We owe our lives and everything we do for God, and we owe our service and ideas for the betterment of the people of our country.

4. REFERENCES

Brown, I. (2020). AI won't replace humans, just like computers didn't. *Theiet.org*.
<https://eandt.theiet.org/content/articles/2020/08/a-i-won-t-replace-humans-just-like-computers-didn-t/>

Coeckelbergh, M. (2010). Moral appearances: emotions, robots, and human morality. *Ethics and Information Technology*, 12(3), 235–241. doi:10.1007/s10676-010-9221-y

Coeckelbergh, M. (2013). The Moral Standing of Machines: Towards a Relational and Non-Cartesian Moral Hermeneutics. *Philosophy & Technology*, 27(1), 61–77. doi:10.1007/s13347-013-0133-8

Danaher, J. (2017). Ethical Behaviourism in the Age of the Robot. *Philosophical Disquisitions*. Retrieved from <https://philosophicaldisquisitions.blogspot.com/2017/12/ethical-behaviourism-in-age-of-robot.html>.

Danaher, J. (2020). Welcoming Robots into the Moral Circle: A Defense of Ethical Behaviorism. *Science and Engineering Ethics*, (4): 2023-2049. Retrieved from <https://philpapers.org/archive/DANWRI>

Fletcher, J. (1972). Indicators of Humanhood: A Tentative Profile of Man. *The Hastings Center Report*, 2(5), 1. <https://doi.org/10.2307/3561570>

Headland, C. J., Teahan, W. J., & ap Cenydd, L. (2019). Sexbots: a case for artificial ethical agents. *Connection Science*, 32(2), 204–221. <https://doi.org/10.1080/09540091.2019.1640185>

Jaworska, A., & Tannenbaum, J. (2013). The Grounds of Moral Status (*Stanford Encyclopedia of Philosophy*). Stanford.edu. <https://plato.stanford.edu/entries/grounds-moral-status/>

May, W. E. (1976). What Makes A Human Being To Be A Being of Moral Worth? *The Thomist: A Speculative Quarterly Review*, 40(3), 416–443. doi:10.1353/tho.1976.0012

Musial, M. (2017). Designing (artificial) people to serve - the other side of the coin. *Journal of Experimental & Theoretical Artificial Intelligence*, 29 (5), 1087-1097.

Petersen, S. (2007). The ethics of robot servitude. *Journal of Experimental and Theoretical Artificial Intelligence*, 19 (1): 43-54. <https://philpapers.org/rec/PETTEO>

Petersen, S. (2011). Designing People to Serve. In Patrick Lin, George Bekey & Keith Abney (eds.), *Robot Ethics*. MIT Press.

Petersen, S. (2016). Is it good for them too? Ethical concern for the sexbots. <https://philpapers.org/archive/PETIIG.pdf>

Searle, J. (1980). The Chinese Room. <https://rntintin.colorado.edu/~vancecd/phil201/Searle.pdf>

Turing, A. (1950). Computing Machinery and Intelligence. *Mind*, 49 (433-460).



An Ethical Assessment of Philippine Laws on National Security through Deontological Ethics

David Joseph O. Velasco
De La Salle University Integrated School, Manila

Abstract: As a democratic country, the Philippines value the natural rights enshrined in the Constitution. Filipinos, particularly those who were involved in the preservation of democracy, were up in arms when the Republic Act 11479 or the Anti-Terrorism Act and formerly, the repealed Republic Act 9372 or the Human Security Act were passed. Filipinos fear that both infringe on basic human rights, such as that of right to life, liberty, and property. For this reason, there is a need to encourage research that will assess these laws concerning the national security of the country, in an ethical manner, in order to shed light on the ethical basis of these laws whether or not they abide by the foundational moral theories in promoting the national security of the Philippines.

Key Words: national security; deontology; ethics; human rights; natural rights.

1. INTRODUCTION

1.1 Background of the Study

The field of ethics involves systemizing, defending, and recommending concepts of right and wrong behavior. Ethics is something that is present in our daily lives but is often overlooked by people who deem it relative to an individual's desires and beliefs because they think that philosophy and ethics are subjects that are highly theoretical which don't affect the lives of people in ways which they could see directly and tangibly.

This study focuses on deontological ethics as we relate it to the Philippine Laws regarding National Security. Deontology is a theory proposed by Immanuel Kant, a German philosopher and one of the most influential philosophers in history. The theory states that as humans, we have a set of rules and principles that we need to follow, where the theory is based on the person's actions and not the outcome. On the other hand, John Locke, an English philosopher and widely regarded as one of the most influential Enlightenment thinkers or as the "Father of Liberalism", proposed the natural rights theory. Locke's natural rights theory highlights the inalienable natural rights that every human being has. These are God-given rights that cannot be taken away or even given away. Among these fundamental rights are "life, liberty, and property."

People often think that ethics is often black and white, where it only aims to avoid harming the innocent, but sometimes it may also force people to sacrifice lives for the good of the nation. An example of this would be whether or not to sacrifice individual human rights for the security of a nation. But what exactly is the boundary when it comes to taking

actions that would otherwise be wrong?

1.2 Statement of the Problem

To present an ethical assessment of Philippine Laws on National Security using Deontological Ethics, specifically to compare the human rights aspect of pertinent provisions of the two laws using the aforementioned theories.

1.3 Scope and Limitations

The study is limited to the two laws, the Human Security Act of 2007 and Anti-Terrorism Law, using only Deontology. This research will focus on evaluating said laws by conducting a series of philosophical and legal analyses. The research will not tackle anything beyond these laws, nor will it use other theories in Ethics as a mode of assessment to deem whether said laws are ethical or not.

2. METHODOLOGY

The researcher of this study conducted archival research by searching for books, literature, as well as news articles relevant to the topic. Primary sources of this paper include Republic Act No. 9372, Republic Act 11479, Universal Declaration of Human Rights (UDHR), Bill of Rights, Case Laws, and Groundwork of the Metaphysics of Morals by Immanuel Kant; secondary sources of this paper are news articles. The researcher used legal and philosophical analysis to draw conclusions for this study. No interviews were conducted for this research.

Primary sources were chosen for this study for the reason that these sources will allow the researcher, as well as the readers, to analyze the said laws on national security. While the secondary



sources, such as news articles, will provide additional information that may be used in analyzing the two laws.

3. RESULTS AND DISCUSSION

3.1 Deontology and Natural Rights

Upon analyzing Immanuel Kant's theory of deontological ethics, it allowed this study to have a deeper understanding of the concepts of deontology and how it is applied in real life. In Kant's theory, it was stated that people are morally obligated to act in accordance with a set of principles and rules regardless of the outcome. Kant's deontological ethics theory holds the principle that some acts are always wrong, even if the act results in an admirable outcome. Therefore, actions in deontology are the sole basis of being ethically correct or wrong and are always judged independently from their outcomes. On the other hand, John Locke's theory of natural rights highlights the inalienable natural rights of every human being. He pointed out that among these fundamental natural rights are "life, liberty, and property." The first fundamental right, life, pertains to individuals having both rights and duty to preserve their own lives. On the other hand, Liberty argues that all individuals should be free to make their own choices on how to live their own lives. And lastly, property pertains not only to material possessions but rather ownership of one's self; this includes a right to personal well-being. Moreover, it is worth noting that according to Locke, these rights are God-given and can never be taken or even given away hence the reason why Locke believes that the ideal government will encompass preservations of these three rights for all, each and every one, of its citizens.

3.2 Due Process

Article III, Section 1 of the Bill of Rights, which discusses the concept of due process or equal protection, states that "No person shall be deprived of life, liberty, or property without due process of law, nor shall any person be denied the equal protection of the laws." This section provides protection against the accused by providing them a proper justice system that allows them to have an opportunity to be heard and explain one's side without repercussions or prejudice.

As per Section 27 of the Anti-Terrorism Law—Preliminary Order of Proscription, which states that when there is a probable cause, the Court of Appeals upon application by the Department of Justice within 72 hours issues a preliminary order of proscription is necessary to prevent the commission of terrorism declaring the respondent as a terrorist. Zeroing on this section of the Anti-Terrorism Law, it

can be drawn that it does not abide by the Philippine Constitution as the person under suspicion of terrorism will not undergo the proper judicial process, thereby disregarding Article III, Section 1 of the Bill of Rights which states that "No person shall be deprived of life, liberty, or property without due process of law, nor shall any person be denied the equal protection of the laws."

The discussion of deontology and natural rights shows that section 27 of the Anti-Terrorism Law not only violates the Philippine Constitution but as well as deontological ethics. As it was established in the former part of this study that deontological principles believe that actions are judged independently from the outcomes, thereby making this section of the law unethical. It is worth noting that in hindsight, this section of the law has the potential to prevent future acts of terrorism, ergo saving thousands or even millions of lives. However, the Philippine Constitution deems this act as unconstitutional and violates human rights; moreover, deontological ethics rules this section of the law unethical since it sacrifices the rights of a person no matter what the outcome may be. Furthermore, this section of the law compromises the safety of those who are wrongfully accused, thereby strengthening why this law is unethical based on deontology.

3.3 Search and Seizure

In Article III, Section 2 of the Bill of Rights, this provision of the Philippine Constitution protects the people against unreasonable searches and seizures without a proper search warrant or warrant of arrest with the exception of a probable cause determined by a judge and particularly describing the place to be searched or person to be seized. This section of the bill of rights allows people to be secure in their persons and houses as well as restricting the State from abusing their power.

Republic Act 11479 or the Anti-Terrorism Act of 2020 in Section 29—Detention Without Judicial Warrant of Arrest, this section of the law explicitly states that any law enforcement agent duly authorized by ATC has taken custody of persons suspected of sections 4-12 of the Anti-Terrorism Law shall deliver the suspected person to proper judicial authority within a period of 14 days from the moment the suspect was arrested without incurring any criminal liability. This section of the Anti-Terrorism Law violates Article III, Section 2 of the Bill of Rights as it allows law enforcement to conduct unlawful searches and arrests without a warrant issued by a judge. In the case of Marissa Torres, who accused two policemen of conducting a warrantless search and arrest in her own household on January 29, 2020, the accused were demoted from their positions as the Quezon City People's Law Enforcement Board ruled that under the



Philippine Constitution. The accused argued that their search and seizure could be justified under the plain view doctrine as they claimed that they noticed a suspected firearm in Torres' sling bag. However, the QC PLEB ruled that the warrantless arrest and search and seizure conducted by the policemen cannot be justified under the plain view doctrine; hence the accused actually conducted an illegal and unlawful arrest against Torres.

Moreover, in the discussion of deontology and natural rights, this section of the aforementioned law also does not abide by the principles that deontology and natural rights uphold. While one can be argued that detaining a person for up to 14 days without a judicial warrant of arrest would be acceptable since they are suspected of terrorism and may commit acts of terrorism that may endanger the lives of millions, however, in Kant's theory of deontology, the most logical solution or the solution that will benefit the most will not always be ethical. Upon analyzing this particular section of the Anti-Terrorism law using deontology, it could be drawn that it does not adhere to the beliefs and principles of deontology hence it is deemed unethical. In Torres' case, the two policemen decided to search and seize Torres without the proper judicial warrant since they suspected that she had a firearm; though the intentions of the policemen were good, it still violated the rights of Torres ergo making their actions unethical since based on deontology, the actions are judged independently from their outcome, therefore, sacrificing the rights of the accused of the greater good is impermissible. Furthermore, Locke's natural rights theory supports Kant's arguments in deontology since according to Locke, natural rights are inalienable and that individuals have both rights and duty to preserve their own lives.

3.4 Privacy of Communication

Article III, Section 3 of the Philippine Constitution, protects the privacy of communication of persons. This right is inviolable except upon lawful order of the court or when public safety or order requires otherwise, as prescribed by law. Moreover, this section of the law also states that any evidence obtained in violation of this or the preceding section shall be inadmissible for any purpose in any proceeding.

Under Section 16 —Surveillance of Suspects and Interception and Recording of Communications, of the Anti-Terrorism Act of 2020, notwithstanding the Republic Act No. 4200 or otherwise known as the "Anti-Wire Tapping Law", allows law enforcement or military personnel to secret wiretap, overhear, and listen to, intercept, screen, read, surveil, record, or collect, any private communications, conversations, discussions, data, information, or messages of any person charged with or suspected of committing

terrorism for up to 60 days upon written order of the Court of Appeals. Though this section of the Anti-Terrorism Law somewhat abides by Article III, Section 3 of the Philippine Constitution, Colmenares (2021) argues that how is it possible for the court to know if there is a crime that is being or about to be committed. Colmenares also added that just because it [apprehend criminals] is an important or serious concern, it does not mean that the fundamental rights of others can be violated. Furthermore, it can also be argued that the surveillance of suspected terrorists that can last up to 60 days is comparatively long as opposed to the former national security law, the Human Security Act of 2007.

Taking Kant's deontological ethics theory, as well as Locke's natural rights theory, this section of the law does not abide by the principles that these theories adhere to. In this case, invasion of privacy of a person, whether or not they are suspected of terrorism, is still frowned upon, hence this section of the law is not ethical from a deontological perspective. As stated by Colmenares, the constitution requires that basic rights must be followed, basic steps must be followed. This supports Locke's belief that the government should encompass preservations of the three fundamental rights, life, liberty, and property, for each and every one of its citizens.

4. CONCLUSIONS

Upon analyzing the two aforementioned laws in this paper, this study has found out that some of the sections of the newly enacted Anti-Terrorism Act of 2020 are not ethical based on the standards of Deontology and John Locke's natural rights theory. Not only that but it also does not abide by some provisions of the Philippine Constitution and risks the human rights of the citizens of the Philippines. Certain provisions of the new national security law can be classified as unconstitutional, hence the importance of this study. It is noteworthy that this paper is not against laws on terrorism but rather aims that the laws on terrorism be compliant with the Philippine Constitution as well as it does not violate natural and human rights. Furthermore, this paper does not aim to oppose the Anti-Terrorism Act of 2020 but rather to shed some light on some of the unconstitutional provisions of this law. By analyzing the aforementioned law, this study allows us to create better laws in the future that not only prevent future acts of terrorism but also protect the rights of individuals and upholds the Philippine Constitution.



5. ACKNOWLEDGMENTS

The researcher would like to thank the continuous support and assistance of Mr. Lambert Yancy Garganta during the duration of the research.

6. REFERENCES

Allen, Anita L., "An Ethical Duty to Protect One's Own Information Privacy?" (2013). Faculty Scholarship at Penn Law. 451. https://scholarship.law.upenn.edu/faculty_scholarship/451

Bayer, P.B. (2013). The Individual Mandate's Due Process Legality: A Kantian Explanation, and Why It Matters. *Scholarly Works*. Paper 775. <http://scholars.law.unlv.edu/facpub/775>

Cruz, I. (2007). *Constitutional Law*. Quezon City: Central Book Supply, Inc.

Finnis, J. (1980). *Natural Law and Natural Rights*. Oxford University Press.

Hurtubise, M.F. (1952). *Philosophy of Natural Rights According to John Locke*. Retrieved from: https://ecommons.luc.edu/luc_theses/1057

Kant, I. (1785). *Groundwork of the Metaphysics of Morals*. In *Practical Philosophy*, 37-108. Retrieved from: https://books.google.com.ph/books/about/The_Metaphysic_of_Ethics.html?id=cbOHJb66pCcC&printsec=frontcover&source=kp_read_button&redir_esc=y#v=onepage&q&f=false

Kantian Ethics. (n.d.). Retrieved from: <https://www.csus.edu/indiv/g/gaskilld/ethics/kantian%20ethics.htm>

Langbroek, P., van den Bos, K., Thomas, M. S., Milo, M., van Rossum, W. (2017). *Methodology of Legal Research: Challenges and Opportunities*. *Utrecht Law Review*. Volume 13, Issue 3. <http://doi.org/10.18352/ulr.411>

Lechner, S. (2011). Kantian ethics. *Kantian Review*, 16(1), 141. doi:10.1017/S1369415410000129

Marquez, C. (2020). 2 QC cops demoted for unlawful arrest, warrantless search. Retrieved from: <https://newsinfo.inquirer.net/1375925/2-qc-cops-demoted-for-unlawful-arrest-searching-without-warrants>
Republic Act No. 9372 or Human Security Act of 2007

Republic Act No. 11479 or Anti-Terrorism Act of 2020

Talabong, R. (2021). Justice Carandang: 'Can terrorism be prevented without surveillance?' <https://www.rappler.com/nation/supreme-court-justice-carandang-asks-can-terrorism-prevented-without-surveillance-oral-arguments-anti-terror-law>

The 1987 Constitution of the Republic of the Philippines
United Nations Human Rights (n.d.). What are Human Rights? Retrieved from: <https://www.ohchr.org/en/issues/pages/whatarehumanrights.aspx>



POSTER PRESENTATION



Online Distance Learning in Baras-Pinugay: Grade 11 HUMSS & TVL Students’ Challenges and Opportunities

John Carlo B. Bajaro, Princess C. Cenina, Aijah Mae Q. Caritativo, Amorelle Balbero
 and Darren Rey C. Javier

Baras-Pinugay Integrated High School - Senior High, Baras, Rizal

Abstract: The COVID-19 pandemic forced government officials to declare a state of emergency in the Philippines. The Department of Education (DepEd) strived for an efficient way to bring knowledge to students even without face-to-face classes. DepEd proposed online distance learning (ODL), whereby classes will be conducted remotely using online platforms. While most studies in the Division of Rizal focused on the teaching strategies, effectiveness of modular distance learning, research guide in the new normal (Andres, Discutido, & Martos, 2020; Caezar & Parungao, 2020; Robles & Miranda, 2020), no study has explored the challenges, issues, and possible opportunities among ODL students. Hence, this paper attempted to qualitatively investigate the challenges and opportunities of the said learning modality among SHS students. A total of ten Grade 11 students from HUMSS and TVL strands were conveniently (Barrot, 2018) selected as participants of the study. Online semi-structured interview was done to collect data. Findings provided an overview of trials and prospects of students’ experiences in ODL based on the six major themes developed. Implications for teachers were also drawn from this study.

Key Words: COVID-19 pandemic; Department of Education; new normal in education; online distance learning; senior high student

1. INTRODUCTION

The fight against the new coronavirus pandemic has led to profound effects on almost all sectors of human society. This includes widespread interruption such as travel restrictions (Chinazzi, et al. 2020), global economic recession (Fernandes, 2020), misinformation and controversies (Enitan, Ibeh, Oluremi, Olajanyu, & Itodo, 2020) to name a few. Responses like lockdown and community quarantine have led students and teachers to study and work at home using online platforms.

In the Philippines, Mateo (2021) mentioned in his article that government officials had immediately suspended the traditional face-to-face classes with the threat of high transmission among students during early 2020. The Department of Education had set an alternative learning modality (Briones, 2020), whereby teaching is undertaken remotely and on digital platforms.

Due to the uncertainty brought by the pandemic, the use of available technical resources to facilitate online distance learning (ODL) has become one of the solutions. Thus, a sudden transformation of classroom instruction might happen in School Year 2020-2021, as Javier (2020) mentioned in his essay.

With the advancement of technology, ODL becomes feasible. For synchronous sessions, teachers are using free online applications like Google Meet

and Zoom. While for asynchronous sessions, they use Facebook groups, Google classroom, Edmodo, and others.

Nevertheless, ODL has its limitations, including unstable internet connection and unsatisfactory digital skills of students. Some benefits, such as flexibility, can also be a limitation, especially for students working at the same time.

While most studies in the Division of Rizal focus on the teaching strategies, the effectiveness of modular distance learning, and research guide in the new normal (Andres, Discutido, & Martos, 2020; Caezar & Parungao, 2020; Robles & Miranda, 2020; Sacramento, Ibañez, & Magayon, 2020), no studies have investigated the challenges, issues, and possible opportunities happening amongst students.

This research aims to adequately understand the students' circumstances and opportunities under the ODL format. Strengthening the practices in the new learning setup is a concern to make it more responsive to the learning needs of students. Hence, this study provides an overview of the effects of online learning among students to provide classroom teachers recommendations on enhancing the implementation of ODL.



1.1 Research Questions

1. What are the challenges and difficulties faced by Grade 11 HUMMS and TVL students during ODL?
2. What are the opportunities these SHS students have during ODL?

2. METHODOLOGY

2.1 Research Design

The study aims to understand the student challenges, difficulties, and opportunities while in ODL. The study used a directed approach of content analysis by Hsieh and Shannon (2005) to validate or extend conceptually the themes from the interviews. The data was collected through online semi-structured interviews, with open-ended questions, to explore the participants' experiences.

2.2 Sampling

A total of ten Grade 11 HUMSS and TVL students participated in the study. They were divided into two groups, five from the Humanities and Social Sciences (HUMSS) and five from the Technical-Vocational-Livelihood (TVL). Barrot's (2018) convenience sampling technique was used considering the voluntary nature of the study. These Grade 11 students who are officially enrolled in Baras-Pinugay Integrated High School for the School Year 2020-2021 were considered in the study because (1) the said grade level has only two strands; and (2) they have the most active number of students attending ODL.

2.3 Data Collection

The interviews were conducted virtually since face-to-face interactions were prohibited based on the Inter-Agency Task Force (IATF) guidelines. The participants were scheduled for the interview based on their availability. This is to ensure the time-on-task policy of the department.

2.4 Data Analysis

The study was guided by Hsieh and Shannon's (2005) directed content analysis; hence challenges and opportunities that were beyond the principles were still noted for possible extended findings for the study. A teacher who has been teaching for almost eleven years and an early career researcher served as the intercoder for this work. In addition, the help of an intercoder, who validated the analysis of the interview transcripts, was sought to guarantee the validity, reliability, and quality of the results..

3. RESULTS AND DISCUSSION

3.1 The Challenges and Difficulties faced by Grade 11 HUMMS and TVL Students in Online Distance Learning

3.1.1 On Students' Internet Stability

It is crucial to have an internet stable enough to support the online learning of students. However, most of the participants revealed having a hard time when it comes to internet stability. Since ODL is conducted virtually, students face challenges due to the unstable internet. In fact, four out of five participants from TVL and two out of five participants from HUMSS claimed that an unstable connection makes it difficult to understand the lessons being discussed.

TVL Student E: "I cannot clearly understand the lessons because of the intermittent sound and voice. I missed an online class because of the unstable internet as well, sometimes no internet at all. This is making it hard to attend online classes via Google Meet."

In the above extract, the participant expressed struggles in understanding the lessons taught in online classes.

TVL Student C: "The connection is very unstable because we can't keep up with the lesson and sometimes our account automatically leaves Google Meet."

Similar to the first extract, the participant struggled in coping with the lessons due to internet issues.

3.1.2 On External Barriers

Learning is better with a good environment. Four out of five TVL participants and three out of five participants in HUMSS revealed difficulties when studying because of distractions in their environment, noise specifically.

HUMSS Student D: "Because of the loud barking of the dog, the shouting, and the high-volume radio of our neighbor, sometimes I could not understand what our teacher was saying."

TVL Student D: "Noises are a big disadvantage especially when children are playing in front of our house, I am not able to hear the discussion of my teachers so sometimes I can't understand it at all."

Participants had trouble understanding the teacher's discussion due to noise from the neighborhood, including barking of dogs, high volume of radio, people shouting, and children playing in the street.

HUMSS Student C: "Outside nuisance can really be troublesome especially with synchronous activities"



since it is live. The background noises can ruin your focus in the lesson.”

The participants had trouble due to external barriers, and these affected their focus in class.

3.1.3 On Lack of Parental Support

With the significant shift in the academic setting, it must be imperative for students to have parental support in their studies since this is significantly related to academic achievement (Javier & Jubay, 2019). There is an agreement between the participants regarding the necessity for parental support. Data from four out of five TVL participants and four out of five HUMSS participants revealed how parental support affects their learning.

HUMSS Student A: “If parents will not support their children with their education, the student might lose his or her motivation causing them to neglect their responsibility.”

HUMSS Student C: “I think if your parents won’t support you, you’ll lose your inspiration and motivation in doing your activities.”

TVL Student C: “It is quite difficult to study without parent’s support as this adds to the problem of a student that may result for him/her to stop studying.”

In the extracts, the participants perceived lack of parental support as a factor adding to students’ stress. Parental support is necessary for a student’s motivation and prevents a student from neglecting their responsibility.

3.2 The Opportunities of SHS Students in Online Distance Learning

3.2.1 On Comfortability

Despite having drawbacks, the brighter side of ODL is that it provides comfortability among students, away from the danger caused by the global pandemic.

HUMSS Student E: “It is better because it is quiet, I am able to answer my tasks thoroughly and am not rushed.”

Since classes are conducted virtually, students are not obliged to finish their tasks within the day and after each class, they can easily loosen up. This gives them more opportunity to thoroughly execute their tasks.

HUMSS Student C: “At first it was awkward, answering with my parents listening but as time went by, I got used to it and it is much more comfortable now.”

HUMSS Student D: “I’m having a hard time because I’m not used to this kind of study but as time goes on, I’ve been enjoying it.”

Within the comfort of the learner’s home, their parents can freely observe their learning ability, boosting their performance academically.

3.2.2 On Affordability

Online learning is more cost-efficient compared to physical learning. Online learning eliminates the cost points of student transportation, student meals, and most importantly, real estate (Gautam, 2020). Students do not need to pay for unnecessary things such as transportation fares. Learners can easily access their lessons and with the paperless submissions for their activities, it is highly evident that online learning is much more affordable.

TVL Student E: “Face-to-face classes cost much more than online class. You do not have to spend much now that you are at home. I also do not need to spend for buying notebooks for different subjects.”

TVL Student C: “ODL is cost-efficient because my parents don’t need to spend for my expenses (allowance, lunch, snacks, etc.) because I am studying at home.”

It shows that ODL can also cut the cost for students like travel expenses, allowance, food, and others. This allows their parents to allocate the intended budget for the expenses to other household needs.

Online learning cuts most of the costs needed for physical learning, making it more cost-effective for the student’s family.

3.2.3 On Time-Management

With flexibility comes the need for students to prioritize their time accordingly (Best, 2020). ODL promotes student’s responsiveness when it comes to managing their time for future purposes too.

Students’ schedules are flexible, giving them the accountability for their time. It molds the student’s ability to organize what they need to do next to efficiently make use of their allotted time.

They are free from the obligations of studying at a specific time, but this raises their awareness of doing their responsibility as a student naturally.

TVL Student C: “I do not need to wake myself early just to prepare stuff and go to school, I only need to prepare myself and my device for online class. I can freely manage my time as well because there is allotted time for online classes. I can spend my remaining time doing household chores and other things. I can also synchronize doing household chores and attend my class too.”

TVL Student E: “I can do house chores after my classes online, sometimes I am able to do my house chores and online classes at once. I can manage my time more effectively unlike in the face-to-face classes.”



Because of ODL, some students can even multitask. Learners are allocating specific time to study based on their own preferences, making their performance better.

HUMSS Student A: "Now that I can control my own time when it comes to studying and doing household chores, it is much easier for me to move and decide what I should do next."

With ODL as a learning modality, students systematically decide what they will do for a single day, making them more progressive and efficient.

4. CONCLUSIONS

The educational landscape is highly affected by the COVID-19 pandemic. In the Division of Rizal, this study presented some of the new normal situations in the school setting. Students are experiencing problems in ODL, but they see a silver lining amidst these issues. Teachers are encouraged to extend understanding because students are still coping with the changes in the new normal.

Classroom teachers must tailor-fit their online instructions to meet the needs of diverse students, even though there are challenges on how to provide and deliver quality education amidst exceptional times. Localized and contextualized online instructions will make learning engaging and meaningful among students.

The study has limitations since it only surveys a few participants and focuses only on ODL students in consideration of the COVID-19 pandemic. It is suggested that future studies in line with ODL should have more participants and do quantitative research using the themes generated in the current study to obtain more data that will help teachers and school administrators revisit and recalibrate the current School Learning Continuity Plan.

This present study hopes to shed light on the issues and challenges of ODL students which will help schools improve the delivery of ODL. Finally, this study gives significant input to some of the lived experiences of students during the pandemic.

5. ACKNOWLEDGMENTS

The research team would like to thank Mrs. Benja L. Legion, officer-in-charge of BPIHS Senior High Department, and Dr. Marvin B. Se, Principal I, for allowing the student-researchers to conduct the study virtually among the senior high students of BPIHS.

Thanks a million also to Dr. Se for supporting the student-researchers in their pursuit of presenting the study in the 3rd De La Salle University Senior High School Research Congress.

Sincerest thanks as well to the ten student-participants who agreed on taking part in the study.

Likewise, the student-researchers would like to express their gratitude to Mr. Ramier P. Jubay Jr., SHS HUMSS Teacher III, for reviewing and proofreading this paper.

6. REFERENCES

- Abad, F. B. (2005, March 5). Instituting measures to increase engaged time-on-task and ensuring compliance therewith [DepEd Order]. <https://bit.ly/3xaA0GT>
- Andres, M. G., Discutido, R. A., & Martos, G. S. (2020, December 5). Development and acceptability of introduction, methodology, results, and discussion (IMRaD) style as a guide in writing research report [Paper Presentation]. 7th Virtual Division Research Conference. <https://bit.ly/3pXRgvb>
- Barrot, J. (2018). Practical research 1 for senior high school. C&E Publishing Inc. ISBN: 978-971-98-0974-6. <https://bit.ly/3n4c7Mz>
- Best, J. (2020, March 9). 5 surprising benefits of distance education. <https://bit.ly/39ejg7q>
- Briones, L. M. (2020, June 19). Adoption of the basic education learning continuity plan for school year 2020-2021 in light of the COVID-19 public health emergency [DepEd Order]. https://www.deped.gov.ph/wp-content/uploads/2020/06/DO_s2020_012.pdf
- Caezar, J. P. & Parungao, D. R. (2020, December 5). Effectiveness of modular approach in SMSHS (Grade 11-ABM): A response to the new normal [Paper Presentation]. 7th Virtual Division Research Conference. <https://bit.ly/3pXRgvb>
- Chinazzi, M., Davis, J. T., Ajelli, M., Gioannini, C., Litvinova, M., Merler, S., Piontti, A. P., Mu, K., Rossi, L., Sun, K., Viboud, C., Xiong, X., Yu, H., Halloran, E., Longini, I. R., & Vespignani, A. (2020). The effect of travel restrictions on the spread of the 2019 novel coronavirus (COVID-19) outbreak. *Science*, 368, 6489, pp. 395-400. <https://science.sciencemag.org/content/368/6489/395/tab-pdf>
- Enitan, S., Ibeh, I., Oluremi, A., Olajanyu, A., & Itodo, G. (2020). The 2019 novel coronavirus outbreak: Current crises, controversies, and global strategies to prevent a pandemic. *International Pathogen Research*, 4(1), pp. 1-16. <https://www.journalijpr.com/>
- Fernandez, N. (2020). Economic effects of coronavirus outbreak (COVID-19) on the world economy [Unpublished Article]. <https://doi.org/10.2139/ssrn.3557504>
- Gautam, P. (2020, October 10). Advantages and disadvantages of online learning. <https://elearningindustry.com/advantages-and-disadvantages-online-learning>



- Hsieh, H. & Shannon, S. E. (2005). Three approaches to qualitative analysis. *Qualitative Health Research*, 15 (9).
<https://journals.sagepub.com/doi/10.1177/1049732305276687>
- Javier, D. R. C. & Jubay, R. P. (2019). Exploring parent-teacher collaboration to improve students' vocabulary skills: An action research. *International Journal of Linguistics, Literature, and Translation*, 2(5), pp. 194-203.
<https://bit.ly/3aiBsNN>
- Javier, D. R. C. (2020). Education in Rizal province during the COVID-19 pandemic. *The Antoninus Journal*, 6, COVID-19 Special Issue.
<http://theantoninus.com.ph/archives/58/>
- Mateo, J. (2021, January 3). Distance learning becomes new norm for Philippines' education. *Philstar Global*. <https://bit.ly/30gPhGU>
- Robles, V. R. A. & Miranda, E. F. R. (2020, December 5). Spartan's localized alternative delivery mode: An evaluation [Paper Presentation]. 7th Virtual Division Research Conference.
<https://bit.ly/3pXRgvb>
- Sacramento, M. G., Ibañez, G. S., & Magayon, M. V. C. (2020, December 5). Exploratory study on technology adaptation of teachers and students under LCP: An input for learners' accommodation and instructional modification [Paper Presentation]. 7th Virtual Division Research Conference. <https://bit.ly/3pXRgvb>



The Effect of Using Exoskeleton of Blue Crab (*Callinectes sapidus*) as a Dietary Calcium Source on the Egg Characteristics of Layer Hens (*Gallus gallus domesticus*)

Kurt Nheil A. Cueto, Matthew Alexander B. De Villa, and Richard Francis R. Torres
Philippine Science High School - CALABARZON Region Campus, Batangas City, Batangas

Abstract: The study focuses on the ability to use the exoskeleton of blue crab as alternative calcium and carotenoid supplement for layer hens and its effects on egg characteristics. Three groups of eighty layer hens each were fed a base feed formulation following the standards of the University of the Philippines Los Baños. The feeds were base feed as negative control (NG), a base feed with natural egg yolk colorants (capsorubin and lutein) as positive control (PG), and a base feed with 1% ground blue crab exoskeletons, as experimental (EG). The feeding lasted four weeks before egg collection. The eggs were weighed for their albumen, yolk, shell, and egg weight. The egg yolk color was determined using a DSM Fan and a digital Chroma meter, and the shell thickness using digital calipers. Statistical treatment was done through Kruskal Wallis test using SPSS software. Results showed that eggs of EG had significantly heavier shells with a mean of 5.93 ± 0.11 g, compared to 5.83 ± 0.08 g of the NG and 5.55 ± 0.08 g of the PG. Eggshell thickness was not significantly different among the three groups. Egg yolk color was significantly different in PG with a mean DSM gradient value of 11.96 ± 0.11 , compared to 5.92 ± 0.14 of the NG and 6.48 ± 0.20 of EG. Ground blue crab exoskeleton as a calcium supplement may increase the weight of the eggshells but may not intensify the egg yolk color.

Key Words: Layer hens; calcium; carotenoid; crab; egg

1. INTRODUCTION

According to the Philippine Statistics Authority (2019), egg production has grown, at the highest rate of increase, by 43.4% from January 2019 to March 2019. The industry has produced 142.01 metric tons of eggs from January to March of 2019, as opposed to the 130.55 metric tons of eggs produced in the same months of the previous year.

Layer hens (*Gallus gallus domesticus*) are domesticated chickens bred specifically for the production of eggs. According to the Philippine Statistics Authority (2019), as of July 2019, there are 40.4 million-layer hens in inventory. The feeds consist of raw ingredients which contain the nutritional requirements of laying hens. These include sources of energy and carbohydrates, protein, vitamins, minerals, and oils (PHILSAN, 2003).

For layer hens, a key component of their feeds is the mineral source, specifically calcium. Calcium increases the quality of the egg in terms of its shell. With its increasing demand for feeds, the layer hen industry varies in sources of calcium, such as limestone grits and limestone fines. The average commercial feed supplemented with calcium carbonate grit usually has sufficient calcium, phosphorus, manganese, and vitamin D to produce sound shells (Ahmadi et al., 2011).

Egg yolk color is also an essential parameter of egg quality. There are egg yolk colorants, which act as a feed component to intensify or modify the color of egg yolks from chickens that consume them. The number of egg colorants added on feeds is vital because, according to Zaheer (2017), the yolk color is “largely dependent on hen’s feed composition.” The yolk color is important to consumers’ acceptability because a richer-colored yolk meant a healthier and more nutritious egg since the hen’s diet came from natural pigments (Severson, 2020). Some egg colorants are capsorubin and lutein, making the egg yolk slightly darker and lighter, respectively. Capsorubin is a natural pigment found in chili peppers, which coexists with capsaicin to provide dark red colors. It is an excellent source of vitamin A and contains dietary fiber, vitamin E, B6, and folate (Hassan et al., 2019). On the other hand, Lutein is a natural pigment in vegetables, which gives them their bright, yellow pigment (Zaheer, 2017).

This study used *Callinectes sapidus*, commonly known as blue crabs, widely used for human consumption. The study utilized the exoskeleton of *C. sapidus* since this is being discarded and considered as factory waste after the meat from this crab is extracted and manufactured into other food products.



The exoskeleton of a blue crab covers almost all parts of its body and consists of multiple components, including calcium carbonate (CaCO₃), estimated to comprise 27.5% of the total exoskeleton. This may make it a viable source of dietary calcium for layer hens. In line with this, the study aimed to assess if using crab exoskeleton as a dietary calcium source may increase the hardness and thickness of layer hen eggshells. The crab exoskeleton also contains carotenoids, which may modify the egg yolk color.

Proximate analysis is a standardized series of tests to feed to determine crude protein, crude fiber, crude fat, crude ash, dry matter, and moisture content (Mæhre, 2018). It is done using various tests using different apparatuses for each substance measured and is a standardized test for chicken and pig feeds. This was used to determine the calcium content of the crab shells.

Following the statements above, this study aims to investigate the effect of using crab exoskeletons as a dietary calcium source on the egg quality of layer hens in terms of egg characteristics, specifically, egg weight, egg yolk weight, albumen weight, shell thickness, and egg yolk color.

2. METHODOLOGY

2.1 Site and duration of the study

The study was conducted from January 2020 to February 2020 at the University Animal Farm, Institute of Animal Science, College of Agriculture and Food Science, University of the Philippines Los Baños, Laguna.

2.2 Experimental design

A total of two-hundred forty (240) laying hens, provided by the UPLB-IAS, were housed and fed at the University Animal Farm and were at post-peak of production (H&N Super Nick).

The hens were randomly allotted to three different dietary treatments of ten replicates, each with eight chickens. The total number of laid eggs was recorded daily. Egg characteristics were recorded during the last week of feeding.

2.3 Feed formulation and feeding

Three different experimental layer diets had been formulated in crumble form. The first diet was the control diet with a formulation given by UPLB-IAS. The second diet was the same formulation as the first diet added with one kilogram per ton of capsorubin and one kilogram per ton of lutein, both provided by UPLB-IAS. The third diet was also the same formulation as the first diet added with 1% crab shell meal. The base feed was milled with respective components using a mill. Each pen was offered with

their diet and water ad libitum for four weeks. The diet composition used for feeding the hens is shown in Table 2.1.

Table 2.1 Composition of Experimental Diets of Layer Hens

Ingredient	Amount (%)		
	Negative Control Diet	Positive Control Diet	Experimental Diet
Corn	46.22	46.22	46.22
Soya	29.52	29.52	29.52
Limestone	9.46	9.46	9.46
RBD 1	7.78	7.78	7.78
Coco oil	2.65	2.65	2.65
Molasses	2	2	2
MDCP	1.53	1.53	1.53
Iodized Salt	0.25	0.25	0.25
Vitamins	0.12	0.12	0.12
DL-meth	0.12	0.12	0.12
Choline Powder	0.1	0.1	0.1
Minerals	0.1	0.1	0.1
Toxin binder	0.05	0.05	0.05
Mold inhibitor	0.05	0.05	0.05
Antioxidant	0.05	0.05	0.05
Crab meal	0	0	1
Capsorubin (per ton)	0	0.1	0
Lutein (per ton)	0	0.1	0

2.4 Proximate analysis

The crab exoskeleton had undergone proximate analysis at LQCC. Proximate analysis was done to determine the components of the exoskeleton of the crab. The guidelines given by LQCC were followed for the preparation of crab shell meals for analysis. The components of the base diet are gathered through the indicated values in the sack of the feed.

2.5 Data collection

Eggs were collected for analysis at the end of the 28-day experimental period with 139 eggs. Individual eggs were weighed using a standard digital weighing scale. The eggs were broken manually, and the egg yolk was separated from the egg white using a manual egg separator. The color of the egg yolks was measured in two different methods. The first method used a DSM Yolk fan and was performed by one researcher only. The second method used a Konica Minolta Chroma Meter CR-410, provided by UPLB-IAS Director. The Chroma meter was calibrated first before the start of collection using the proper procedure instructed by the manufacturer. The shell thickness was measured using a digital caliper and was measured in three different parts of an egg, the tip, middle, and butt. Shell weight was recorded after eight (8) days of drying at room temperature.



2.5 Statistical Treatment

The data collected from the eggs were analyzed statistically using the Kruskal-Wallis test at 95% confidence interval through SPSS statistical software to observe the differences between the values of the variables, which are the egg qualities, among the three groups. The researchers originally planned to use One-way ANOVA by comparing the mean of the variables from each treatment since this is the most suitable statistical analysis for the data because this can determine if there is a significant difference in the effect of the independent variables (treatments) to the dependent variables (egg qualities). However, the data violated multiple assumptions of tests, including the normality using Kolmogorov-Smirnov test and homogeneity of variance using Levene's test returning results unsuitable for One-way ANOVA. The data also underwent screening using box plotting to determine extreme outliers. The groups were compared to each other to determine if there is a significant difference among the groups. They were further compared by pair to decide which groups contained substantial differences.

Table 3.1 Summary of Means and Kruskal Wallis Analysis of the egg characteristics at 95% confidence interval ($\alpha = 0.05$).

Treatment	Weight (g)				Shell thickness (mm)	Chroma meter			(DSM yolk Fan)
	Egg	Egg White	Yolk	(Shell)		(L*)	(a*)	(b*)	
Negative	63.65±0.82	36.41±0.67	17.61±0.26	5.84±0.9b	82.66±0.320±0.01a	b	10.18±0.21b	56.46±0.81b	5.91±0.14ac
Experimental	63.37±0.91	35.71±0.70	17.60±0.29	5.95±0.1a	82.35±0.316±0.01	a	10.92±0.30a	56.00±0.61a	6.51±0.20ab
Positive	62.10±0.77	34.97±0.57	17.33±0.23	5.57±0.9ab	74.61±0.296±0.01a	ab	23.75±0.28ab	51.33±0.64ab	11.95±0.12bc

Results were presented as mean ± S.E. of 10 replicates observation. groups with significant difference ($p < 0.05$) have parenthesis in their row heading. L* is a measurement of black to white on a scale of 0 to 100. a* is a measurement of green (-) to red (+). b* is a measurement of blue (-) to yellow (+). Values with the same letter (a,b) in the same column are significantly different from each other.

3. RESULTS

3.1 Weight

In Table 4.1, the negative control group (NCG) exhibits the highest values in egg yolk, egg white, and the whole egg weight among the other groups.

The experimental group (EG) has the highest value in shell weight, which is significantly higher than the positive control group (PCG) but not with the NCG. The difference between the three groups is significantly different.

3.2 Shell Thickness

In Table 4.1, the negative control group exhibits the highest eggshell thickness value compared to the other group. It is only significantly higher in the positive control group and not in the experimental group.

3.3 Yolk color

In terms of Chroma meter measure measurement, PCG has the highest a* value which means it is the reddest in color among the feeds. Still, it also has the lowest value in L* and b*, which indicates that it has a darker color and the least yellow. It also exhibited the highest yolk color rating in terms of the DSM yolk Fan, with a mean of 11.95

In comparing NCG and EG, NCG has a greater L* value which means it is more light-colored than EG; however, its a* value is less than the experimental, which indicates that the experimental is redder in color. The highest b* value is shown by the negative control group, which means it is the most yellow.

4. DISCUSSION

From the results, it can be said that there is no significant difference ($\alpha = 0.05$) in the effect of *C. sapidus*-based feeds on egg weight when compared among the groups.

NCG has the heaviest albumen weight values, whereas EG may have lighter weight but has values that can be attributed to calcium content. This was supported by data in the study of Ribeiro et al. (2016), where they also observed that increasing the amount of calcium in the diet decreases the amount of albumen in the egg.

In terms of shell weight, the EG has the highest value. It supports the proximate analysis of experimental feed and crab meal that it has higher calcium content than the other group. This was in line with the study of Ribeiro, et al. (2016) since their research observed that an increase in calcium content also increases the shell weight. There is a significant difference ($\alpha = 0.05$) in *C. sapidus*-based feeds on shell weight compared to the groups.

The NCG has the highest shell thickness value, but its feed calcium content does not contain the highest calcium. There is a significant difference ($\alpha = 0.05$) in the effect of *C. sapidus*-based feeds on shell thickness when compared to the PCG but has no significant difference when compared to the NCG. There may be other factors that affect the eggshell thickness, including the physical characteristics of the layer hen.

For the yolk color based on the Chroma meter, the NCG and the EG have values that are not



significantly different, but the PCG has a significantly different value than the two groups. There is a significant difference ($\alpha=0.05$) in the effect of *C. sapidus*-based feeds on yolk color L^* , a^* , and b^* when compared among the groups. There is a significant difference in *C. sapidus*-based feeds on yolk color L^* , a^* , and b^* when compared to the PCG but has no significant difference compared to the NCG.

There is a significant difference ($\alpha=0.05$) in *C. sapidus*-based feeds on DSM fan yolk color compared to the groups. The PCG also exhibited the highest yolk color rating in terms of the DSM yolk Fan, with a mean of 11.96 among the varied group. Since the PCG is the basal feed diet supplemented with capsorubin and lutein as egg yolk colorants, the egg yolk color would appear to become much brighter among the three groups. This is supported by Grashorn (2016) study, where it was found that the addition of red and yellow colorants in the egg affects the color of the yolk, which makes it more golden-orange.

5. CONCLUSION

In the study, three groups of layer hens were subjected to three different treatments, NCG, PCG, and EG.

The EG had the eggshells with the most positive significant weight difference but did not significantly change the egg yolk color compared to the NCG. The PCG had the most different egg yolk color yield among the treatments. It could be said from here that ground crab exoskeleton may be a viable calcium supplement for layer hen feeds but may not be a viable egg yolk colorant.

The proximate analysis results further support the effectiveness of the crab exoskeletons as a calcium supplement due to the calcium composition of the crab meal being higher than that of the basal feed diet at 23.59%.

However, compared to limestone grits, the most commonly used calcium supplement, ground crab exoskeleton, has a considerably lower calcium content. Thus, it could be said that limestone grits may still be more effective as a calcium supplement on a basal feed diet. With these mentioned, it can be concluded that ground crab exoskeletons have the potential to be used as a commercially available calcium supplement for layer hens but not as a viable source of egg yolk colorant. However, it may work in conjunction with the egg colorants used in the PCG, namely capsorubin and lutein, as supplements for calcium and egg yolk colorants.

6. ACKNOWLEDGMENTS

First and foremost, the researchers would like to extend their deepest gratitude to our Almighty God, who Has been the unfailing provider of strength

and wisdom throughout the difficulties in Research 2 and Research 3.

To Dr. Noel B. Lumbo, for guiding the researchers in the study and collaborating with their project. He covered the financial expenses that the researchers were to have regarding the study.

To Dr. Rommel C. Sulabo, for allowing the researchers to perform in UPLB under the Institute of Animal Science with Dr. Lumbo and for providing the Chroma meter used in the study.

To the University of the Philippines Los Baños – Institute of Animal Science (UPLB-IAS), for allowing the researchers to perform their research and use their facilities.

To University Farm Staff of UPLB-IAS, for feeding hens and collecting eggs at the university farm.

To Ms. Avril Ley Ann V. Recto, for teaching and assisting the researchers with the writing of this paper.

To Mr. John Joshua A. Azucena, for aiding and assisting the researchers with the content and principles behind this paper.

To Mrs. Cladys M. Falcunaya, for notifying and helping the researchers to participate in a research competition.

To Mr. Christopher M. Cordero & Ms. Shiela Liz L. Ativo, for assisting the researchers with the statistical treatments used in this paper.

To Mr. Michael G. Bustos, Mrs. Bergilda A. Cueto & Mr. Augustus A. De Villa, for helping the researchers with transportation to and from Batangas and Laguna, and for assisting the researchers with communication with UPLB.

To Mrs. Violeta P. Napere & Mrs. Armi Joy N. Ayop, for allowing the researchers to stay at their home overnight after returning from UPLB.

To Ms. Kayla Marie D. Manguiat, for helping the researchers with data recording during the tests on egg characteristics. Her laptop was also used for storing the data at the time.

7. REFERENCES

- Ahmadi, F & Rahimi, F. (2011), Factors Affecting Quality and Quantity of Egg Production in Laying Hens: A Review, IDOSI Publications
- Ahmed, N. Abdel Atti, K. Elamin, K. Dafalla, K. Malik, H. Dousa, B. (2013). Effect of Dietary Calcium Sources on Laying Hens Performance and Egg Quality. *Journal of Production Advances* 3(7): 226-231. doi: 10.5455/japa.20130718034818
- Arnarson, A. (2017). The Benefits and Risks of Eating Eggshells. Retrieved from <https://www.healthline.com/nutrition/eggshells-benefits-and-risks>



- Boßelmann, F., Romano, P., Fabritius, H., Raabe, D., & Epple, M. (2007). The composition of the exoskeleton of two crustacea: The American lobster *Homarus americanus* and the edible crab *Cancer pagurus*. *Thermochimica Acta*, 463(1-2), 65–68. doi: 10.1016/j.tca.2007.07.018
- Brun, L. Lupo, M. Delorenzi, D. De Loreto, V. & Rigalli, A. (2013). Chicken eggshell as suitable calcium source at home. *International Journal of Food Sciences and Nutrition*. 64(6):740-3. doi: 10.3109/09637486.2013.787399.
- Chen, W. Zhao, F. Tian, Z. Zhang H. Ruan, D. Li, Y. Wang, S. Zheng C. Lin, Y. (2015). Dietary calcium deficiency in laying ducks impairs eggshell quality by suppressing shell biomineralization. *Journal of Experimental Biology* 218, 3336-3343. doi:10.1242/jeb.124347
- Davis, Jen. (2019). How many pounds of Food does a Laying Hen Eat a Day? Retrieved from <https://animals.mom.me/many-pounds-food-laying-hen-eat-day-5860.html>
- DSM Bright Science. Brighter Living. (2018). DSM egg quality manual: A practical guide to the efficient evaluation of egg quality at farm level. Retrieved from https://www.dsm.com/content/dam/dsm/anh/en_US/documents/DSM-egg-quality-manual.PDF
- Egg Farmers of Alberta. (2019). Types of Eggs. Retrieved from <https://eggs.ab.ca/eggs/types-of-eggs/>
- Encyclopedia. (2019). Chitin. Retrieved from <https://www.encyclopedia.com/science-and-technology/biochemistry/biochemistry/chitin>
- Grashorn, M. (2016). Feed Additives for Influencing Chicken Meat and Egg Yolk Color. *Handbook on Natural Pigments in Food and Beverages*, 283–302. doi:10.1016/b978-0-08-100371-8.00014-2
- H&N International. (2019). Layer Performance Data Datos de producción ponedora Performances de Production Pondeuse. Retrieved from https://www.hn-int.com/eng-wAssets/docs/leaflets/Layers/H-N_Super-Nick_Leaflet_07.19.pdf
- Hassan, N. et al. (2019). Carotenoids of Capsicum Fruits: Pigment Profile and Health-Promoting Functional Attributes. Retrieved from mohdhassan2019.pdf
- Helmenstine, A. M. (2019). Blue Crab Facts. Retrieved from <https://www.thoughtco.com/blue-crab-facts-4770253>
- Helmenstine, A. M. (2018). How to Change the Color of an Egg Yolk. Retrieved from <https://www.thoughtco.com/how-to-change-egg-yolk-color-607441>.
- Koirala, A. (2020). Factors Affecting Quality Egg Production. Retrieved from https://www.farm.com.np/student_articles/mr-aavas-koirala/
- Li, Q., Liu, Q., Zhang, C., Cheng, Y., & Wu, X. (2019). Can color-related traits in the Chinese mitten crab (*Eriocheir sinensis*) be improved through quantitative genetic inheritance? *Aquaculture*, 512, 734355. doi: 10.1016/j.aquaculture.2019.734355
- Mæhre, H. et al. (2018). Protein Determination—Method Matters. Retrieved from <https://www.mdpi.com/2304-8158/7/1/5>
- Minolta, K. (2019). Chroma meter CR-400. Retrieved from <https://sensing.konicaminolta.asia/product/chroma-meter-cr-400/>
- Moreno, J. A., Díaz-Gómez, J., Nogareda, C., Angulo, E., Sandmann, G., Portero-Otin, M., Christou, P. (2016). The distribution of carotenoids in hens fed on biofortified maize is influenced by feed composition, absorption, resource allocation and storage. *Scientific Reports*, 6(1). doi:10.1038/srep35346
- Organic Valley. (2019). What Does an Egg's Yolk Color Mean? Rootstock. Retrieved from <https://www.organicvalley.coop/blog/what-does-egg-yolk-color-mean/>
- ORKA Food Technology. (2019). DSM Yolk Color Fan. Retrieved from <https://eggtester.com/dsm-yolk-color-fan/>
- Philippine Society of Animal Nutritionists (2003) *Feed Reference Standards*, 3rd Edition, PHILSAN
- Philippine Society of Animal Nutritionists (2003) *Feed Reference Standards*, 4th Edition, PHILSAN, retrieved from http://www.bafs.da.gov.ph/images/Approved_Philippine_Standards/PNS-BAFS163-2015AnimalFeedIngredients.pdf
- Quarmby, R., Nordens, D. A., Zagalsky, P. F., Soniak, M. (2012). Why Do Crabs and Lobsters Turn Red When You Cook Them? Retrieved from <https://www.mentalfloss.com/article/31483/why-do-crabs-and-lobsters-turn-red-when-you-cook-them>
- Ribeiro, C., Barreto, S., Reis, R., Muniz, J., Viana, G., Junior, V. R., . . . Degroot, A. (2016). The Effect of Calcium and Available Phosphorus Levels on Performance, Egg Quality and Bone Characteristics of Japanese Quails at End of the Egg-Production Phase. *Revista Brasileira De Ciência Avícola*, 18(Spe), 33-40. doi:10.1590/1806-9061-2015-0014
- Severson, K. (2020). What An Egg Yolk's Color Can Tell You About Its Nutritional Value. Huffpost. Retrieved from https://www.huffpost.com/entry/egg-yolk-color_n_5bd7357de4b0a8f17efa9109



- Sparrey, J., Sandercock, D. A., Sparks, N. H. C., & Sandilands, V. (2014). Current and novel methods for killing poultry individually on-farm. *World's Poultry Science Journal*, 70(04), 737–758. doi:10.1017/s0043933914000816
- Świątkiewicz, S. Arczewska-Włosek, A. Krawczyk, J. Puchala, M. Józefiak, D. (2015). Effects on performance and eggshell quality of particle size of calcium sources in laying hens' diets with different Ca concentrations. *Arch. Anim. Breed.*, 58, 301–307. doi:10.5194/aab-58-301-2015
- Świątkiewicz, S. Arczewska-Włosek, A. Krawczyk, J. Szczurek, W. Puchala, M. (2018). Effect of Selected Feed Additives on Egg Performance and Eggshell quality in Laying Hens Fed a Diet with Standard or Decreased Calcium Content. *Ann. Anim. Sci.*, Vol. 18, No. 1 (2018) 167–183. doi: 10.1515/aoas-2017-0038
- The DSM YolkFan™. (2018). Retrieved from https://www.dsm.com/markets/anh/en_US/products/products-solutions/products_solutions_tools/Products_solutions_tools_EggYolk.html.
- Tunç, A. E., & Cufadar, Y. (2014). Effect of Calcium Sources and Particle Size on Performance and Eggshell Quality in Laying Hens. *Turkish Journal of Agriculture - Food Science and Technology*, 3(4), 205. doi:10.24925/turjaf.v3i4.205-209.262
- United Producers Certified. (2019). Choices in Hen Housing. Retrieved from <https://uepcertified.com/choices-in-hen-housing/>
- University of Georgia. (2020). Poultry Mortality Disposal: Methods Following Catastrophic Loss. Retrieved from <https://extension.uga.edu/publications/detail.html?number=B1342&title=Poultry%20Mortality%20Disposal:%20Methods%20Following%20Catastrophic%20Loss>
- Valkonen, E., Venäläinen, E., Rossow, L., & Valaja, J. (2010). Effects of calcium diet supplements on egg strength in conventional and furnished cages, and effects of 2 different nest floor materials. *Poultry Science*, 89(11), 2307-2316. doi:10.3382/ps.2010-00700
- Wilson, D. (2017). 7 Potential Benefits of Astaxanthin. Healthline. Retrieved from <https://www.healthline.com/health/health-claims-astaxanthin>
- Zaheer, K. (2017). Hen egg carotenoids (lutein and zeaxanthin) and nutritional impacts on human health: a review. *CyTA - Journal of Food*, 15(3), 474–487. Retrieved from doi:10.1080/19476337.2016.1266033
- Zulfan, Z., Latif, H., Fitri, C. A., & Aswita, E. (2020). Effect of Feeding Quails with Mixture Feeds Composed of Crab Waste Meal, Leubim Fish Waste Meal, and Broken Rice Grains as Partly Substitution of Commercial Diet on Egg Quality. *Animal Production*, 22(2), 82-91. Retrieved from <https://doi.org/10.20884/1.jap.2020.22.2.50>



COVID-19 Swab Test Experiences of Employees as Required By Their Employers

Isabel C. Barroquillo, Hannah Grace V. Menor, Chariz Estelle M. Segunla
and Rae Crystal C. Yia

St. Edward School, General Trias City, Cavite

Abstract: Undergoing swab tests to ensure a safe work environment was required by the national government due to the COVID-19 pandemic. The Department of Labor and Employment (DOLE, 2020) stated the need for regular swab testing of workers in various sectors to prevent the further spread of the virus. Data was gathered from the employees of the Bridgestone Company in Rosario, Cavite. The study aims to know the experiences of the Bridgestone employees who underwent the COVID-19 swab testing and to know how they viewed it in the context of workforce productivity. The researchers used a phenomenological approach and utilized interview guides for the data collection. Seventeen questions were asked during the course of collecting data, and participants were selected based on quota sampling. The findings showed that the process of undergoing the COVID-19 swab test was painful, yet the procedure was done quickly. Conclusions of the findings showed that undergoing the swab test was painful, but it was essential and contributed to the productivity of the employees of the Bridgestone Company.

Key Words: swab testing; COVID-19; experiences; productivity; pandemic

1. INTRODUCTION

Despite the COVID-19 pandemic, work continues and thus is affected by the implementation of travel bans, skeleton crews, remote work, and social distancing. In many organizations, these changes have raised questions and concerns (Anthony & Patrick, 2020). With the implementation of such protocols, the Philippine government required swab testing for employees to ensure a safe working environment. The COVID-19 swab test involves a six-inch-long nasopharyngeal swab cavity inserted between the nose and mouth (UC Davis Health, 2020). This process must be done regularly to prevent the further transmission of the disease within offices and factories (Department of Labor and Employment [DOLE], 2020).

As COVID-19 spread in two hundred sixteen countries, the disease was considered a health crisis pandemic by the World Health Organization (WHO, 2020). There has been an excess of eighty thousand reported cases as of 2020 in the Philippines, as reported by the Department of Health (DOH). Cases continue to rise, and it exerts implications on the jobs of citizens. As swab testing was implemented, DOH Undersecretary Marie Rosario Vergerie claims that the laboratories of the Philippine Red Cross are capable of conducting five thousand tests a day (Gonzales, 2020).

Williams and Haire (2020) stated that the operation of swab testing may cause fears, such as

fearing the swab test procedure, suspicions on government and healthcare programs, and possible results from the extent of public health inspections. Hence, the fear of COVID-19 and its implications must be addressed since it may lead to enhanced job outcomes, increased job satisfaction, decreased levels of stress, and reduced intention to resign from their profession (Labargue & Delos Santos, 2020).

Furthermore, the researchers wanted to know the experiences of the Bridgestone employees who underwent the COVID-19 swab-testing and how they viewed the swab test procedure in the context of productivity within the workforce during the pandemic.

2. METHODOLOGY

Research Design

The researchers conducted the study using the phenomenological approach. As defined by Sokolowski (2000), phenomenology is the study of peoples' experiences and how they present themselves to others. The phenomenological design attempts to understand the meaning and significance of a particular phenomenon (Manen, 1990).

Method of Collecting Data and Development of Research Instrument

The researchers used an interview guide to collect data. It consisted of seventeen questions



regarding the participants' subjective and necessary personal data. Interview guides were used during the interviews to help the researchers focus on the topic. Moreover, conducting interviews was appropriate for this study since it explores various views, experiences, beliefs, and motivations (Gill et al., 2008). They helped the researchers understand the attitudes, actions, perceptions, and experiences of the participants toward the matter being studied.

Sampling Design

The researchers used quota sampling for the selection of participants. According to Saunders, Lewis, and Thornhill (2012), quota sampling is a method of non-probability sampling and can be described as a sampling method for collecting representative data from a population. Its implementation ensures that a sample group represents certain features of the population selected by the researchers. For practical purposes, Crouch and McKenzie (2006) recommend that fewer than twenty participants in a qualitative study assist a researcher to develop and sustain a close relationship, thus enhancing the "open" and "frank" exchange of knowledge. Moreover, Creswell (1998) proposes five to twenty-five participants for phenomenological studies, and Morse (1994) suggests at least six. These guidelines help a researcher predict how many participants they need. However, the necessary number of participants should still depend on when saturation is achieved.

Ten employees were gathered by the researchers. The area of the study was restricted to Bridgestone Precision Molding Philippines, Inc. in Rosario, Cavite. An unstructured interview for the study was administered to all ten participants. The selection of the participants was conducted from the population of Bridgestone employees that were required to undergo the COVID-19 swab test and whose availability and attitude was compatible with the study. The size and length of the interview guide were kept optimum.

3. RESULTS AND DISCUSSION

3.1 What are the experiences of the Bridgestone employees who underwent the COVID-19 swab testing?

Nervousness was a typical reaction for those who experienced swab testing for fear of the COVID-19 pandemic. The participants felt nervous about the results as they thought that their results were positive. They feared that they might infect their family and loved ones. Some employees were sad due to the possible discrimination a test result might give them. The data of the participants were collected for

tracing and to check their background. This procedure was done by the authority who executed the swab test, ensuring a proper diagnosis.

The nose and throat swab test can miss around thirty percent to fifty percent of infections, according to the University of Cambridge team (as cited in Boseley, 2020), since the virus can disappear from the upper lung unto the lungs. But it can be solved by adding antibody tests that provide sufficient data. Some swabs might not show a hundred percent accuracy. A false-positive result may lead to unnecessary treatment for the uninfected individual. It can also lead to societal dilemmas for people who are essential in public services, such as health and social care operators, police officers, firefighters, and the like. A false-negative result given to a positive patient for COVID-19 may potentially contribute to the spread of the virus by human-to-human transmission.

Participants said that the whole swab testing procedure occurred between one to ten minutes. Physical pain was felt by the participants after the process of swab testing. Additionally, they still needed to wait three days for the result.

3.2 What meanings do the Bridgestone employees give from their experience of swab testing?

Some participants said that swab tests were important for them to be aware if they were affected by the virus or not. The Center for Disease Control (CDC) recommended that critical infrastructure employees may be allowed to continue working after possible exposure to COVID-19, to ensure the continuity of operations of vital functions. It would be more beneficial if everyone would undergo swab testing. This can help provide more explicit pictures for contact tracing and help them assess what they can do to eliminate the virus.

Swab testing can be the employee's protection barrier against the infection of COVID-19. One employee said that the company could not just eliminate people in the workforce (as it might affect the company's production). Most of the participants said that after undergoing the swab test, they became health-conscious.

The participants said they became more well-informed of their surroundings after taking the swab test, considering that they were initially anxious and fearful of the potential consequences of COVID-19. Becoming more conscious can be related to the Protection Motivation Theory's response efficacy.



3.3 How do employees view swab tests in relation to the productivity of the workforce during a pandemic?

Some of the participants said that as part of the swab test process, they were asked to quarantine. Aligned with this, they could not report to work. For companies and employers to prepare for and respond to COVID-19, the CDC developed interim guidelines. The interim guidelines are structured to reduce exposure to acute respiratory diseases, including COVID-19, in the workplace. As group transmission of COVID-19 progresses, the guidelines also discuss concerns that can assist employers. The guidelines are intended for non-healthcare environments; guidelines unique to them should be consulted by healthcare staff and employers. Using appropriate combinations of engineering and administrative controls, safe work practices, and personal protective equipment (PPE) to avoid worker exposure, employers should adjust infection prevention techniques based on a comprehensive hazard assessment (Occupational Safety and Health Administration, 2020).

Some participants also said that the swab test made their production slow as they were scared to interact with each other. A study written by Joel Carnevale and Isabelle Hatak entitled "Employee Adjustment and Well-Being in the Era of COVID-19: Implications for Human Resource Management" claims that COVID-19 is the accelerator for one of the most drastic changes to workplace transformations. Theories that highlight employee-environment theory would be necessary because motivation would be affected by the change in values. The increase in job autonomy may cause family-related problems that may surface within work-from-home situations, so there is a need for providing employees with the right resources to manage conflicting work and family demands. Organizations must also enhance relationship-oriented human resource systems to combat the risk of isolation among independent employees and prepare them for situations like the current crisis (Donthu & Gustafsson, 2020).

The participants said that the swab test helped to bring back the company's full productivity workforce amidst the pandemic. There would be a period after the pandemic when people would tend to focus more on saving capital rather than investing, resulting in reduced economic growth. With the situation, saving capital means negative returns; it is not certain that we would be as conservative as we were in the past. Retailers and brands face challenges related to health and safety, supply chain, the workforce, cash flow, consumer demand, sales, and marketing. But once humanity is through this pandemic, people would have a different world than the world before the pandemic. Companies would

implement an indefinite hiring freeze while online communication, entertainment, and shopping would grow and expand (Donthu & Gustafsson, 2020).

4. CONCLUSIONS

Based on the findings of the study, the following conclusions were drawn:

4.1 The researchers conclude that the conducted COVID-19 swab test returned the company's productivity workforce to one-hundred percent. When the COVID-19 pandemic started, only fifty percent of employees were allowed to work in the company. After conducting the swab test, the company's productivity workforce was able to return to a hundred percent, considering that it helped limit the spread of the virus and diminished the COVID-19 cases in Bridgestone company.

4.2 The researchers conclude that the COVID-19 swab test caused fear and assurance to the Bridgestone Company employees. Before the employees had the swab test, they feared the possibility of becoming positive for COVID-19 and the idea that the swab test process is painful. Afterward, the COVID-19 swab test results provided assurance of whether they were infected or not. They have also become more well-informed about their surroundings and become health conscious after taking the swab test.

4.3 The researchers conclude that the procedure of the COVID-19 swab test was excruciating. After the Bridgestone Company employees took the swab test, they mentioned that they felt physical pain due to the insertion of a six-inch-long swab into the cavity between their nose and mouth.

5. ACKNOWLEDGMENTS

The researchers are sincerely thankful to many individuals of St. Edward School for their assistance and never-ending support. Their contributions are sincerely appreciated and gratefully acknowledged.

Most importantly, gratitude is wholeheartedly expressed to the following individuals, who were the other researchers who have helped in writing and accomplishing this study: John Christian B. Co, Nora Lisa M. Taher, and Stacie Tresh B. Cinco.

Gratitude overflows for their participants, which were employees from Bridgestone Precision Molding Philippines, Inc., who decided to participate in their study and make it a success. For Mrs. Riza Jude Segunla, Ms. Chariz Estelle Segunla's mother,



for helping the researchers to gather the participants. Without their invaluable involvement, the study would not have been completed.

In expression of great recognition for the efforts by Ms. Jovielyn C. Tan, their research adviser and teacher, for instilling knowledge and providing guidance to the researchers throughout.

The researchers would like to express their immense gratitude to Mr. Rodnie Natividad and Ms. Veth Javier, the 3rd DLSU SHS Research Congress: Poster Presentation moderators for St. Edward School-Faith Campus, that helped them complete the activity on time.

The researchers' appreciation also goes to Mr. Anthony M. Grepo, their class adviser, for guiding and supporting them until the completion of this study.

The researchers would also like to extend their gratitude to their family and friends who in one way or another shared their support, either morally or physically.

Hence, the team would like to present all acts of salutations to others who have played a role, big or small, for motivating the team to continue pursuing this study.

Above all, thanks to the Greatest Almighty, the author of knowledge and wisdom, for His showers of blessings and for His countless love.

6. REFERENCES

BBC News (2020, October 03). Coronavirus testing: What is a false positive?. <https://www.bbc.com/news/54270373>

Boseley, S. (2020, September 2). Nasal swab followed by antibody test may catch incorrect COVID-19 diagnoses. *The Guardian*. <https://www.theguardian.com/world/2020/sep/02/nasal-swab-followed-by-antibody-test-may-catch-incorrect-covid-19-diagnoses-testing-uk-coronavirus>.

Centers for Disease Control and Prevention. (2020). Implementing Safety Practices for Critical Infrastructure Workers Who May Have Had Exposure to a Person with Suspected or Confirmed COVID-19. Centers for Disease Control and Prevention. <https://www.cdc.gov/coronavirus/2019-ncov/community/critical-workers/implementing-safety-practices.html>.

Centers for Disease Control and Prevention. (2020). Reducing Stigma. Centers for Disease Control and Prevention. <https://www.cdc.gov/coronavirus/2019-ncov/daily-life-coping/reducing-stigma.html>.

Centers for Disease Control and Prevention (2021, January 5). Test for Past Infection. <https://www.cdc.gov/coronavirus/2019-ncov/testing/serology-overview.html>

Donthu, N., & Gustafsson, A. (2020, June 9). Effects of COVID-19 on business and research. *Journal of Business Research*. <https://www.sciencedirect.com/science/article/pii/S0148296320303830>.

Funk, S., Gilad, E., Watkins, C., & Jansen, V. (2020). (PDF) The Spread of Awareness and Its Impact on Epidemic Outbreaks. https://www.researchgate.net/publication/24245105_The_Spread_of_Awareness_and_Its_Impact_on_Epidemic_Outbreaks.

Gonzales, C. (2020, July 30). Cavite to soon open 'biggest COVID-19 testing lab in the country'. *INQUIRER.net*. <https://newsinfo.inquirer.net/314314/cavite-to-soon-accommodate-10000-covid-19-tests-a-day>.

Haire, B., & Williams, J. (2020, November 23). Blaming the 'worried well' for long COVID testing queues won't help anxious South Australians. *This will. UNSW Newsroom*. <https://newsroom.unsw.edu.au/news/health/blaming-%E2%80%98worried-well%E2%80%99-long-covid-testing-queues-won%E2%80%99t-help-anxious-south-australians>.

Hourly Rate for Skill in Philippines: Public Speaking - Page 2. *PayScale*. https://www.payscale.com/research/PH/Skill=Public_Speaking/Hourly_Rate/Page-2.

How to choose the right support group. (2020, August 29). <https://www.mayoclinic.org/healthy-lifestyle/stress-management/in-depth/support-groups/art-20044655#:~:text=A%20support%20group%20provides%20an,information%20about%20diseases%20or%20re-atments>.

Impact of COVID-19 on employees in the Philippines, May 2020. (2020, May). <https://investinginwomen.asia/knowledge/impact-covid-19-employees-philippines-may-2020/>.

Imperial, I. C., Dellosa, G. K., & Ibanez, J. A. (2020, July). Is the value of anti-SARS-CoV-2 IgA antibody detection underappreciated in our current COVID-19 pandemic response? *Philsciletters*. <https://philsciletters.net/2020/PSL%202020-vol13-no02-p95-100-Imperial%20et%20al.pdf>.

Increased Productivity in the Workplace with Good Relationships with Employees. (2020, December 21) Andy Core. <https://andycore.com/good-relationship-workmates/>

Labrague, L. J., & de los Santos, J. A. A. (2020, October 11). Fear of COVID-19, psychological distress, work satisfaction and turnover intention among frontline nurses. *Wiley Online Library*. <https://onlinelibrary.wiley.com/doi/abs/10.1111/jonm.13168>.

Less Uncomfortable Swab Test for Migrant Workers (2020, October 9). *The Straits Times*. <https://www.straitstimes.com/singapore/health/less-uncomfortable-swab-test-for-migrant-workers>.

Lippi, G., Simundic, A.-M., & Plebani, M. (2020, June 25). Potential preanalytical and analytical vulnerabilities in the laboratory diagnosis of coronavirus disease 2019 (COVID-19). *De Gruyter*. <https://www.degruyter.com/view/journals/cclm/58/7/article-p1070.xml>.

LiveScience (2020, January 05). What Are False Positives and False Negatives? <https://www.livescience.com/32767-what-are-false-positives-and-false-negatives.html>



- Lombardi, A., Consonni, D., Carugno, M., Bozzi, G., Mangioni, D., Muscatello, A., ... Gori, A. (2020, June 20). Characteristics of 1573 healthcare workers who underwent nasopharyngeal swab testing for SARS-CoV-2 in Milan, Lombardy, Italy. *Clinical Microbiology and Infection*.
<https://www.sciencedirect.com/science/article/pii/S1198743X20303542>.
- Manen, M. (2016, September 16). Phenomenology of practice. Retrieved March 19, 2021, from https://books.google.com.ph/books?hl=en&lr=&id=caUYDQAAQBAJ&oi=fnd&pg=PT11∓ots=aEL-pqrIAa&sig=vz9fexvMlcCUHLE816OcIXK84o4∓redir_esc=y#v=onepage&q&f=false
- McCrimmon, K. (2020, December 28). The truth about asymptomatic spread of COVID-19. *UCHealth Today*. <https://www.uchealth.org/today/the-truth-about-asymptomatic-spread-of-covid-19/>.
- Nasal Swab: MedlinePlus Medical Test. (2020, December 1). MedlinePlus. <https://medlineplus.gov/lab-tests/nasal-swab/>
- Otto, N. (2020, February 24). Employers plan big increases to health, wellness budgets. *Employee Benefit News*. <https://www.benefitnews.com/news/employers-plan-big-increases-to-health-wellness-budgets>.
- Panti, L. (2020). Cavite eyes COVID-19 testing for 450,000 residents. <https://www.msn.com/en-ph/news/localnews/cavite-eyes-COVID-19-testing-for-450000-residents/ar-BB12Yawa>.
- Person. (2020, May 10). Coronavirus nasal swab test: is it really painful? <https://www.arabnews.com/node/1672826/saudi-arabia>.
- Prasetyo, Y. T., Castillo, A. M., Salonga, L. J., Sia, J. A., & Seneta, J. A. (2020, August 6). Factors affecting perceived effectiveness of COVID-19 prevention measures among Filipinos during Enhanced Community Quarantine in Luzon, Philippines: Integrating Protection Motivation Theory and extended Theory of Planned Behavior. *International Journal of Infectious Diseases*.
<https://www.sciencedirect.com/science/article/pii/S1201971220306226>.
- Quota sampling - Research Methodology. Research. (2012). <https://research-methodology.net/sampling-in-primary-data-collection/quota-sampling/>.
- Salva et al. (2020). Epidemiological and clinical characteristics of patients with suspected COVID-19 admitted in Metro Manila, Philippines. *Tropical Medicine and Health*.
<https://tropmedhealth.biomedcentral.com/articles/10.1186/s41182-020-00241-8>
- Schmidt, S. B., Grüter, L., Boltzmann, M., & Rollnik, J. D. (2020). Prevalence of serum IgG antibodies against SARS-CoV-2 among clinic staff. *PLOS ONE*.
<https://journals.plos.org/plosone/article?id=10.1371/journal.pone.0235417>.
- Structural Equation Modeling. (2020, December 4). Statistics Solutions.
<https://www.statisticssolutions.com/structural-equation-modeling/>
- Tiangco, M. K. (2020, October 6). Manila begins free mass swab testing for workers. *Manila Bulletin*.
<https://mb.com.ph/2020/10/06/manila-begins-free-mass-swab-testing-for-workers/>.
- Tiangco, M. K. (2020, October 7). Over 400 workers tested in Manila's free mass swab testing operations. *Manila Bulletin*. <https://mb.com.ph/2020/10/07/over-400-workers-tested-in-manilas-free-mass-swab-testing-operations/>.
- UNITED STATES DEPARTMENT OF LABOR. Safety and Health Topics | COVID-19 - Control and Prevention | Occupational Safety and Health Administration. (2020). <https://www.osha.gov/SLTC/COVID-19/controlprevention.html>.
- Villanueva, A. M. G., Lazaro, J., Sayo, A. R., Han, S. M., Ukawa, T., Suzuki, S., ... Smith, C. (2020, July 29). COVID-19 Screening for Healthcare Workers in a Tertiary Infectious Diseases Referral Hospital in Manila, the Philippines. *The American Journal of Tropical Medicine and Hygiene*.
<https://www.ajtmh.org/content/journals/10.4269/ajtmh.20-0715>.
- Williams, J., & Haire, B. (2020, September 6). Why some people don't want to take a COVID-19 test. *The Conversation*. <https://theconversation.com/why-some-people-dont-want-to-take-a-COVID-19-test-141794>.
- Winichakoon, P., Chaiwarith, R., Liwsrisakun, C., Salee, P., Goonna, A., Limsukon, A., & Kaewpoowat, Q. (2020, April 23). Negative Nasopharyngeal and Oropharyngeal Swabs Do Not Rule Out COVID-19. *Journal of clinical microbiology*.
<https://www.ncbi.nlm.nih.gov/pmc/articles/PMC7180262/>.
- World Health Organization (2021, January 5). Tracking COVID-19: Contact Tracing in the digital age <https://www.who.int/news-room/feature-stories/detail/tracking-covid-19-contact-tracing-in-the-digital-age>



A Comparative Analysis on the Mechanical Properties of Abaca, Banana, and Coir Fiber Reinforced Polymer Rebars

Marc Argiel I. Cabigting, Albert Daniel R. Oliver, and Albert Daniel R. Oliver
De La Salle University Integrated School, Manila

Abstract: The researchers conducted a comparative analysis between abaca, banana, and coir FRP rebars to introduce more local and ecological composite materials to the construction industry. This research aims to analyze the mechanical properties of abaca, banana, and coir FRP composites and determine the appropriate chemical treatment and fiber content to yield the most optimum values for each. The values of each composite were compared to each other through bar graphs. The data collected from previous studies were limited to the mechanical properties of tensile, flexural, and impact strength and chemical treatment and fiber content parameters. The type of chemical treatment and the amount of fiber was different among the three NFRP composites. Moreover, abaca had the highest flexural strength, the banana had the highest tensile strength, and coir had the highest impact strength.

Key Words: FRP composite; natural fiber; rebars; mechanical properties; NFRP

1. INTRODUCTION

Rebars are reinforced in concrete structures to increase concrete's tensile strength due to its tension weakness (What is Rebar? Types and Grades of Steel Reinforcement, 2018). Deformed steel rebars are frequently used; however, these types of rebars are corrosive and expensive. Researchers have proposed fiber-reinforced polymer (FRP) rebar as an alternative. They are characterized as lightweight and high strength-to-weight ratio (El-Hassan & El Maaddawy, 2019). FRP rebars are composite materials made of polymer matrix with reinforced fibers (Belarbi & Acun, 2013). Fibers of FRP's are usually synthetic (Begum & Islam, 2013). However, synthetic FRP composites have serious disadvantages: high cost, high density, non-renewable, and high energy consumption. Synthetic FRP composite production results in increased carbon emissions (Sanal & Verma, 2018). The architecture, engineering, and construction industry consume approximately 23% of national energy and produces 40% of carbon emission (Seungho & Seunguk, 2017).

The research problem covers Sustainable Development Goals, 12 & 13, and 9 & 11. Natural FRP (NFRP) rebar is recognized as an ecological alternative to synthetic FRP rebar. Their advantages include low cost, low density, sustainability, and minor damage to processing equipment (Punyamurthy, Sampathkumar, Ranganagowda, et al., 2014). In this study, NFRP rebars, specifically abaca, banana, and coir FRP, were compared. Abaca, banana, and coir fibers are leaf fibers (Mohammed et al., 2015) available in the Philippines. They are used in producing FRP rebars due to their immense mechanical strength, resistance to saltwater damage

and decaying, long fiber length, high tensile and flexural strength (Punyamurthy, Sampathkumar, Bennehalli, & Badyankal, 2014).

This research aims to analyze and compare the mechanical properties (tensile, flexural, and impact strength) of abaca, coir, and banana FRP composites, investigate their mechanical properties when chemically treated, and determine the appropriate fiber content for each. This study may benefit civil and structural engineers, students, and future researchers in finding more local and affordable resources in reinforced concrete and masonry structures.

2. METHODOLOGY

2.1 Nature of Data

The study used secondary sources published from 2010-2020. Sources were collected from databases of Google Scholar, Science Direct, and EBSCO hosts. The numerical data of the mechanical properties were arranged into tables and graphs in Microsoft Excel.

2.2 Identifying Research Objectives

Peer-reviewed journals were used to provide general information about NFRP composites. The study focused on three natural fibers: abaca, banana, and coir fibers. Studies have shown that each kind of NFRP composite requires a certain amount of fiber content and a specific type of chemical treatment to achieve optimum mechanical properties. This led to the formulation of the main research objectives for the study.

2.3 Data Collection

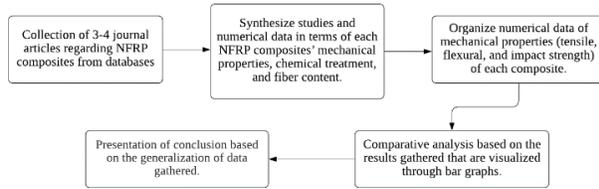

Figure 2.2 General Procedure of the Study

Above is the general procedure of the study. Three to four journal articles per composite were chosen based on their abstract. Selected articles provided the effect of fiber content and chemical treatment on mechanical properties. Parameters such as fiber length and type of matrix were excluded. Upon synthesis of the studies, numerical data of each NFRP composites' mechanical properties were collected. The data collection was patterned after a literature review of natural FRP composites by Mahir et al. (2019).

2.4 Data Organization and Analysis

The researchers arranged numerical data of mechanical properties: tensile, flexural, and impact strength into tables. Abaca, banana, and coir FRP composites had separate tables showing their mechanical properties, corresponding fiber content, and chemical treatment. Mahir et al. (2019) arranged each resin type into tables that show its corresponding fiber type and content and chemical treatment.

Table 2.1 Sample table

Fiber content (wt. %)	Chemical treatment	Tensile strength (MPa)	Flexural strength (MPa)	Impact strength (mJ/mm ²)	Authors
40	Benzene diazonium chloride	-	-	7.68	(Punyamurthy, R. et al, 2014)

Each mechanical property had a bar graph that compared the most optimum mechanical properties of each composite. Another review about natural FRP composites conducted by Vigneshwaran et al. (2020) used bar graphs to compare tensile, flexural, and impact strength among different polypropylene types of natural fiber composites.

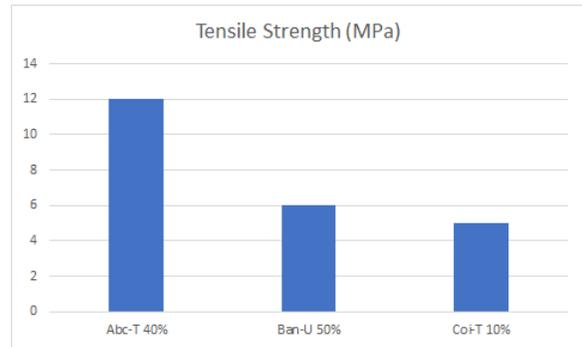

Figure 2.2 Sample Bar Graph

3. RESULTS AND DISCUSSION

3.1 Chemical Treatment and Fiber Content

Chemical treatment aids in the polymer-fiber adhesion by improving compatibility between the hydrophilic fiber and hydrophobic polymer. SEM micrographs analyzed by Rahman et al. (2009) show that untreated abaca fibers display multiple fiber pullouts, micro-voids, and fiber agglomeration resulting in poor fiber-matrix adhesion while treated fibers display better fiber-matrix adhesion. SEM micrographs show that chemical treatment removes hemicellulose and lignin in the fiber, resulting in increased surface roughness (Punyamurthy, Sampathkumar, Bennehalli, Patel, et al., 2014). In table 3.1, benzene diazonium chloride ((C₆H₅N₂)Cl) treatment is mainly included in abaca FRP composites since this treatment exhibit a significant increase in tensile, flexural, and impact strength (Punyamurthy, Sampathkumar, Bennehalli, & Badyankal, 2014). (C₆H₅N₂)Cl treatment lessens the hydrophilic nature of fibers to increase fiber-polymer compatibility through the coupling reaction with the -OH group, producing diazo cellulose compound.

Mechanical properties of abaca FRP composites increased towards the fiber content of 40% then gradually decreased when the fiber content is more than 40% (Punyamurthy, Sampathkumar, Bennehalli, Patel, et al., 2014). As observed in the SEM micrograph analyzed by Punyamurthy, Sampathkumar, Ranganagowda, et al. (2014), the composite with more than 40% fiber content has excess fiber not homogenized with the polymer, while the composite with less than 40% fiber content has fiber fractures which caused inefficient stress transfer. This being the case, 40% fiber content is the most appropriate amount.



Table 3.1 Mechanical Properties of Abaca FRP composite

Fiber content (wt.%)	Chemical treatment	Tensile strength (MPa)	Flexural strength (MPa)	Impact strength (mJ/mm ²)	Authors
40	Benzene diazonium chloride	-	-	7.68	(Punyamurthy, Sampathkumar, Bennehalli, Patel, et al., 2014)
40	Benzene diazonium chloride	73.5	81.2	6.81	(Punyamurthy, Sampathkumar, Ranganagowda, et al., 2014)
10	Benzene diazonium salt	31.2	55.1	4.5 x 10 ⁻³	(Rahman et al., 2009)
25	Benzene diazonium salt	28.7	56	5.3 x 10 ⁻³	(Rahman et al., 2009)
40	Benzene diazonium chloride	73.1	-	-	(Punyamurthy, Sampathkumar, Bennehalli, & Badyankal, 2014)

In table 3.2, alkaline treatment for banana fibers exhibited the most optimum mechanical properties. Alkaline treatment removes hemicellulose and other non-cellulosic substances from the fiber surface thus, improving fiber-matrix adhesion and tensile strength (Komal et al., 2018). SEM micrographs show that alkali-treated banana fibers have clean surfaces and slightly separated fibers (Prasad et al., 2016). The alkaline treatment provides better flexural strength by improving fiber stiffness.

Mechanical properties of untreated fibers decreased when fiber content increased due to weak fiber-polymer compatibility (Prasad et al., 2016). Significant fiber content caused stress transfer inefficiency between the fiber and polymer. This trend is also observed in the tensile strength of treated fibers (Komal et al., 2018). Impact strength decreased as untreated fiber content increased, but improvement in values is seen in the fiber content range of 15%-30%. Although, for the flexural strength of treated fibers, it is observed that values increased as fiber content increased due to improved fiber stiffness. 50% fiber content displayed excellent results to withstand large load amounts (Aswin et al., 2014). In terms of flexural strength and impact strength, 60% fiber content exhibited maximum values.

Table 3.2 Mechanical Properties of Banana FRP composite

Fiber content (wt.%)	Chemical treatment	Tensile strength (MPa)	Flexural strength (MPa)	Impact strength (mJ/mm ²)	Authors
20	-	13.5	22.5	-	(Chester, P., & Jordan, W., 2017)
50	-	112.58	64.68	9.48	(Aswin et al., 2014)
60	-	98.34	77.21	11.2	(Aswin et al., 2014)
25	Alkali treatment	10.9	19.2	11.8	(Prasad, N., Agarwal, V. K., & Sinha, S., 2016)
25	Acrylic acid treatment	10.7	19.9	12.3	(Prasad, N., Agarwal, V. K., & Sinha, S., 2016)
10	Alkaline treatment	28	58	-	(Komal et al., 2018)
20	Alkaline treatment	27	61	-	(Komal et al., 2018)

Coir fiber treated with benzene diazonium treatment exhibit optimum mechanical properties. In table 3, benzene diazonium treatment had the highest tensile strength and flexural strength (Haque et al., 2010). Benzene diazonium treatment caused effective stress transfer between coir fiber and polymer, resulting in improved fiber-polymer matrix adhesion. Sodium bicarbonate treatment does not improve the mechanical properties of fiber since it did not significantly modify the fiber surface for better fiber-polymer compatibility (Santos et al., 2019). However, sodium bicarbonate treatment displayed better impact strength and flexural strength values due to longer treatment time, which caused improvement of fiber stiffness.

The tensile strength of treated composites increased as fiber content decreased. Haque et al. (2010) tested composites with different fiber loadings, 15% being the lowest, and the results showed that 15% got the maximum values of tensile strength. Stress transfer in the composite is more effective in less fiber content. Flexural strength and impact strength of treated composites increased as fiber content increased due to the improved stiffness of the composite. This trend is also the same for untreated fibers. Naveen et al. (2013) observed the tensile strengths of untreated composites at different fiber contents. Maximum values of tensile strength are kept at the lowest fiber content (5%).

Table 3.3 Mechanical Properties of Coir FRP composite

Fiber content (wt.%)	Chemical treatment	Tensile strength (MPa)	Flexural strength (MPa)	Impact strength (mJ/mm ²)	Authors
15	benzene diazonium salt	30.1	56.2	5.6 x 10 ⁻⁵	(Haque et al., 2010)
30	benzene diazonium salt	26.3	58.5	6.2 x 10 ⁻⁵	(Haque et al., 2010)
-	Sodium bicarbonate treatment	18.77	28.37	18.03	(Santos et al., 2019)
-	Sodium bicarbonate treatment	12.53	40.44	6.38	(Santos et al., 2019)
-	Alkali treatment	23.8	40.4	-	(Yan et al., 2016)
5	-	25.2	-	-	(Naveen et al., 2013)

3.2 Tensile Strength

In figure 3.1, coir FRP has the lowest value of tensile strength. Raw coir fibers have low tensile strengths (Yan et al., 2016). This is caused by the chemical composition of coir fiber which contains low cellulose content and large micro-fibrils angle. On the other hand, raw abaca fiber (Punyamurthy, Sampathkumar, Bennehalli, Patel, et al., 2014) and raw banana fiber (Prasad et al., 2016) naturally have high tensile strengths due to their high cellulose content. Untreated banana fiber has the highest value



since its fiber content is 50% which is the appropriate fiber content for banana FRP's. Figure 3.1 shows that banana untreated FRP has the highest tensile strength due to fiber's high cellulose content and proper fiber content in the composite.

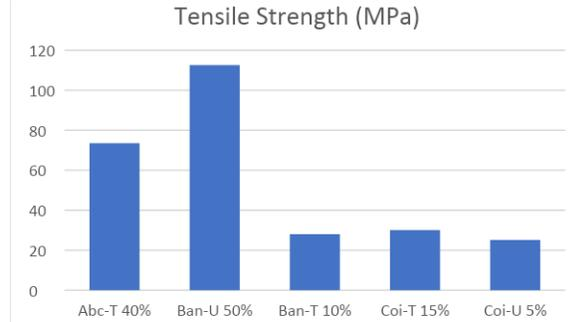

Figure 3.1 Tensile Strength of composites

3.3 Flexural Strength

Abaca and banana fiber FRP display better flexural strength, as seen in Figure 2. Flexural strength of abaca and banana fibers is nearer to that of glass fibers (Punyamurthy, R., Sampathkumar, D., Bennehalli, B., & Badyankal, P., 2014) (Prasad et al., 2016). Abaca FRP treated with 40% fiber content displayed the highest flexural strength. Banana FRP had the lower value since broken banana fibers are arranged perpendicular to the application of flexural loads, shown in SEM micrographs (Aswin, et al., 2014). Banana untreated displayed better flexural strength than banana treated because the fiber content of the untreated FRP is 60%.

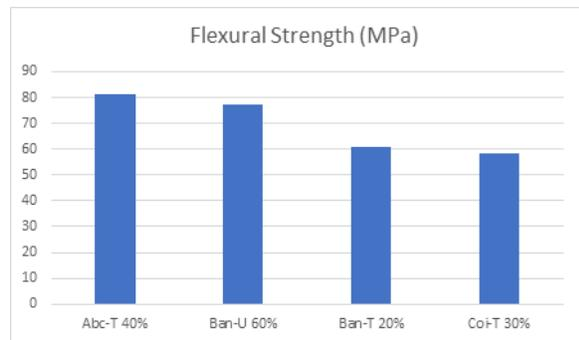

Figure 3.2 Flexural Strength of composites

3.4 Impact Strength

In figure 3, treated coir FRP showed the highest impact strength. SEM micrographs show that low impact strength is associated with better fiber-matrix adhesion and gives rise to fiber fracture, reduced fiber pull-out, and low energy dissipation (Santos et al., 2019). Hence, coir treated FRP is the most optimum because its chemical treatment,

sodium bicarbonate, causes poor fiber-matrix adhesion. Abaca treated FRP displayed the lowest impact strength since its chemical treatment, benzene diazonium, is the most effective treatment for fiber-matrix adhesion, and it causes reduced fiber pull-out (Rahman et al., 2009). More fiber content requires more fiber-pullout force, thus improving impact strength (Haque et al., 2010). For this reason, 60% untreated banana FRP displayed better impact strength compared to 40% treated abaca FRP. Prasad et al. (2016) showed that impact strengths of untreated banana fibers increase from fiber contents of 15%-30%. Thus, 60% treated banana FRP has a slightly lower impact strength value than 25% untreated banana FRP.

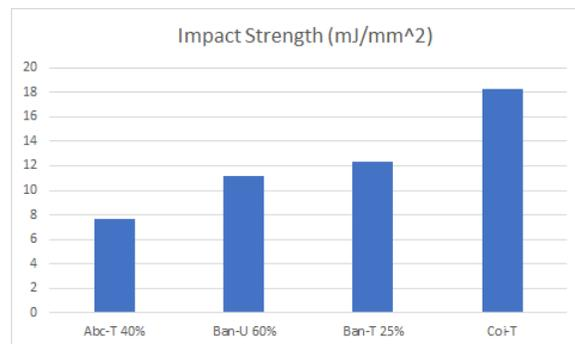

Figure 3.3 Impact Strength of composites

4. CONCLUSIONS

Researchers concluded that the type of chemical treatment and fiber content are different among the three NFRP composites from the studies collected. Abaca FRP composite is most optimum at 40% fiber content, benzene diazonium treatment. Banana FRP composite is most optimum at 50% fiber content, alkaline treatment. Coir FRP composite is most optimum at 15% fiber content, benzene diazonium treatment.

Comparing the mechanical properties among the three NFRP, abaca FRP had the highest flexural strength (81.2 MPa), banana FRP had the highest tensile strength (112.58 MPa), and coir FRP had the highest impact strength (18.03 mJ/mm²).

The study has the potential to exceed the objectives of the study. Modifying variables, specifically the NFRP composites with other local or hybrid NFRP's, is highly recommended to observe improvements in results. Also, other properties of composites such as thermal properties and energy & moisture absorption may be discussed to examine other factors further. Considering other chemical treatments is also encouraged. Use of more established data collection and analysis methods shall be conducted depending on the objectives. Lastly,



exploring other natural fibers and renewable sources must be done to promote the optimization of such resources.

5. ACKNOWLEDGMENTS

First and foremost, the researchers want to extend their gratitude and utmost respect to De La Salle University and the Senior High School Department for allowing them to build their competencies as they produce their study. They also want to thank the Coordinator for Research (STEM), Miss Liezl Rillera-Astudillo, for her guidance in disseminating essential information and dates and attending the STEM strand's queries throughout their research process.

The researchers want to express their appreciation to their research adviser, Engr. Joenel Gales Galupino, for his continuous support and patience throughout the research process. If not for his comprehensive knowledge and recommendations, the researchers would not have produced their study with ease and proficiency.

Added appreciation to the researchers' previous Practical Research professors, Mr. Clement Ong and Dr. Marla Maniquiz-Redillas, for guiding them in the formation of their study; and Jeruel Lawrence Badugas for helping them with their research manuscript.

Lastly, the researchers want to acknowledge the love and gratitude of the Almighty Father for giving them knowledge, principles, courage, and support for the completion of the study and their safety.

6. REFERENCES

- Aswin, U. S., Atreya, T. S. A., Ramesh, M., Eashwar, H., & Deepa, C. (2014). Processing and Mechanical Property Evaluation of Banana Fiber Reinforced Polymer Composites. *Procedia Engineering*, 97, 563–572. <https://doi.org/10.1016/j.proeng.2014.12.284>
- Begum, K., & Islam, M. A. (2013). Natural Fiber as a substitute to Synthetic Fiber in Polymer Composites: A Review. *Research Journal of Engineering Sciences*, 2(3), 46–53. <https://doi.org/>
- Chester, P., & Jordan, W. (2017). Improving the Properties of Banana Fiber Reinforced Polymeric Composites by Treating the Fibers. *Procedia Engineering*, 200, 283–289. <https://doi.org/10.1016/j.proeng.2017.07.040>
- El-Hassan, H., & El Maaddawy, T. (2019). Microstructure Characteristics of GFRP Reinforcing Bars in Harsh Environment. *Advances in Materials Science and Engineering*, 2019, 1–19. <https://doi.org/10.1155/2019/8053843>
- Haque, M., Islam, N., Huque, M., Hasan, M., Islam, S., & Islam, S. (2010). Coir Fiber Reinforced Polypropylene Composites: Physical and Mechanical Properties. *Advanced Composite Materials*, 19(1), 91–106. <https://doi.org/10.1163/092430409x12530067339325>
- Komal, U. K., Verma, V., Aswani, T., Verma, N., & Singh, I. (2018). Effect of chemical treatment on mechanical behavior of banana fiber reinforced polymer composites. *Materials Today: Proceedings*, 5(9), 16983–16989. <https://doi.org/10.1016/j.matpr.2018.04.102>
- Mahir, F. I., Keya, K. N., Sarker, B., Nahiun, K. M., & Khan, R. A. (2019). A brief review on natural fiber used as a replacement of synthetic fiber in polymer composites. *Materials Engineering Research*, 1(2), 88–99. <https://doi.org/10.25082/mer.2019.02.007>
- Mohammed, L., Ansari, M. N. M., Pua, G., Jawaid, M., & Islam, M. S. (2015). A Review on Natural Fiber Reinforced Polymer Composite and Its Applications. *International Journal of Polymer Science*, 2015, 1–15. <https://doi.org/10.1155/2015/243947>
- Naveen, P., & Yasaswi, M. (2013). Experimental analysis of coir fiber reinforced composite materials. *International Journal of Mechanical Engineering and Robotics Research*, 2, 10–18.
- Prasad, N., Agarwal, V. K., & Sinha, S. (2016). Banana fiber reinforced low-density polyethylene composites: effect of chemical treatment and compatibilizer addition. *Iranian Polymer Journal*, 25(3), 229–241. <https://doi.org/10.1007/s13726-016-0416-x>
- Punyamurthy, R., Sampathkumar, D., Bennehalli, B., & Badyankal, P. V. (2014). Study of the effect of chemical treatments on the tensile behaviour of abaca fiber reinforced polypropylene composites. *Journal of Advances in Chemistry*, 10(6), 2814–2822. <https://doi.org/10.24297/jac.v10i6.6668>
- Punyamurthy, R., Sampathkumar, D., Bennehalli, B., Patel, R., & Venkateshappa, S. (2014). Abaca Fiber Reinforced Epoxy Composites: Evaluation of Impact Strength. *International Journal of Sciences: Basic and Applied Research*, 18(2), 305–317.
- Punyamurthy, R., Sampathkumar, D., Ranganagowda, R. P. G., Bennehalli, B., & Srinivasa, C. V. (2017). Mechanical properties of abaca fiber reinforced polypropylene composites: Effect of chemical treatment by benzenediazonium chloride. *Journal of King Saud University - Engineering Sciences*, 29(3), 289–294. <https://doi.org/10.1016/j.jksues.2015.10.004>
- Punyamurthy, R., Sampathkumar, D., Ranganagowda, R. P., Bennehalli, B., Badyankal, P., & Venkateshappa, S. C. (2014). Surface modification of abaca fiber by benzene diazonium chloride treatment and its influence on tensile properties of abaca fiber reinforced polypropylene composites. *Ciência & Tecnologia Dos Materiais*, 26(2), 142–149. <https://doi.org/10.1016/j.ctmat.2015.03.003>
- Rahman, Md. R., Huque, Md. M., Islam, Md. N., & Hasan, M. (2009). Mechanical properties of polypropylene composites reinforced with chemically treated abaca. *Composites Part A: Applied Science and Manufacturing*, 40(4), 511–517. <https://doi.org/10.1016/j.compositesa.2009.01.013>
- Sanal, I., & Verma, D. (2018). Construction Materials Reinforced with Natural Products. *Handbook of Ecomaterials*. https://doi.org/10.1007/978-3-319-48281-1_75-1
- Santos, J. C. dos, Oliveira, L. Á. de, Gomes Vieira, L. M., Mano, V., Freire, R. T. S., & Panzera, T. H. (2019). Eco-friendly sodium bicarbonate treatment and its effect on epoxy and polyester coir fibre composites. *Construction*



- and Building Materials, 211, 427–436.
<https://doi.org/10.1016/j.conbuildmat.2019.03.284>
- Seungho, C., & Seunguk, N. (2017). Article the Reduction of CO2 Emissions by Application of High-Strength Reinforcing Bars to Three Different Structural Systems in South Korea. *Sustainability*, 9(9), 1–24.
<https://doi.org/10.3390/su9091652>
- Vigneshwaran, S., Sundarakannan, R., John, K. M., Joel Johnson, R. D., Prasath, K. A., Ajith, S., Arumugaprabu, V., & Uthayakumar, M. (2020). Recent advancement in the natural fiber polymer composites: A comprehensive review. *Journal of Cleaner Production*, 277, 124109.
<https://doi.org/10.1016/j.jclepro.2020.124109>
- What is Rebar? Types and Grades of Steel Reinforcement. (2018, September 17). *Concrete Technology*.
<https://theconstructor.org/practical-guide/steel-reinforcement-types-grades/24730/>
- Yan, L., Chouw, N., Huang, L., & Kasal, B. (2016). Effect of alkali treatment on microstructure and mechanical properties of coir fibres, coir fibre reinforced-polymer composites and reinforced-cementitious composites. *Construction and Building Materials*, 112, 168–182.
<https://doi.org/10.1016/j.conbuildmat.2016.02.182>



Utilizing Cucurbita moschata Duch. (Winter Squash) Fruit Peels as a Viable Component of Paper

Sophia Angela S. Dy, Jamie Denise N. Sia Tan, Anne Kiezhia T. Wong
and Franchezca Shaira I. Wong
Saint Jude Catholic School, Manila

Abstract: Cucurbita moschata Duch., more commonly known as winter squash, is economically and globally important. However, given that one-third of the food made for human consumption is wasted and never consumed, this fruit is not being utilized to its full potential. As the main component of fruit-based papers such as bananas, coconuts, and corn, winter squash is rich in soluble and insoluble fiber. To resolve the 12th United Nations Sustainable Development Goal: Responsible Consumption and Production, the effectiveness, durability, tensile strength, and biodegradability of winter squash peels as the main component of homemade paper production were investigated. The produced paper underwent 20 trials of tensile strength test, scratch test, and soil burial test using an experimental research design. It was only able to pass the tensile strength test. In contrast, it failed in terms of durability and biodegradability, possibly due to the limited testing procedures and allotted time for testing. Therefore, the utilization of winter squash in paper production was ineffective in terms of the criteria mentioned above and needs further research to be classified as a practical alternative paper component.

Key Words: Cucurbita moschata Duch.; paper; tensile strength; durability; biodegradability

1. INTRODUCTION

1.1 Background of the Study

Ever since the invention of paper, it has been used for various purposes throughout history. Paper has developed into different forms. For instance, according to Aithal (2016), it began as clay tablets for record-keeping in Mesopotamia, which evolved to papyrus—a smooth, flexible aquatic plant that can sustain ink—found in the Nile River, Egypt. The Chinese also had their alternative for papyrus, namely bamboo books, which were just as convenient. Since paper is a multipurpose material, it is commonly and frequently used by almost everyone. The World Counts (2020) states that two to three kilograms of trees are needed for one kilogram of paper. Therefore, the increase in paper production subsequently causes an increase in deforestation. As an alternative to using trees, different waste products can be used to manufacture paper that can alleviate the effects of 1.3 billion tons of food waste and 60% yearly fruit and vegetable waste, as David et al. (2019) stated. Furthermore, the Philippines is the 16th producer of winter squash globally and can produce over 247,759 metric tons each year (Tepper, 2013).

1.2 Statement of the Problem

How can squash peels be utilized to create an effective alternative for paper?

- A. What is the tensile strength of the homemade paper made from squash peels?
- B. What is the durability or stability of the homemade paper made from squash peels?
- C. What is the biodegradability and decomposition of squash peel paper?

1.3 Hypothesis

H01: Squash peels are not effective ingredients of durable paper.

Ha1: Squash peels are effective ingredients of durable paper.

H02: The homemade paper will have a tensile strength of less than 3.6 Pa.

Ha2: The homemade paper will have a tensile strength of 3.6 Pa or more.

H03: The homemade paper will be able to endure less than forty-six (46) trials of being written.

Ha3: The homemade paper will be able to endure forty-six (46) or more trials of being written.

H04: The homemade paper will not show signs of decomposition after ten days buried in the soil.

Ha4: The homemade paper will show decomposition ten days after it is buried in the soil.

1. 4 Conceptual Framework

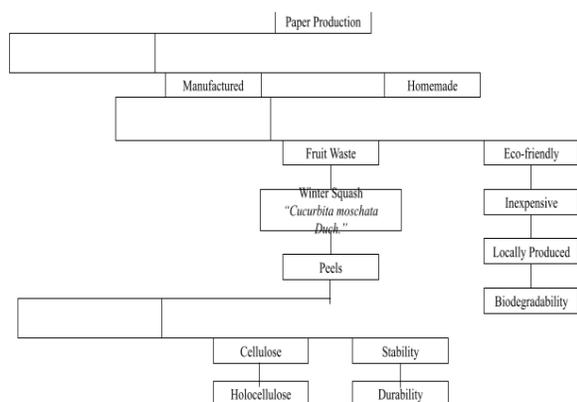

Figure 1.1 Conceptual Framework for the Paper Production

As shown in Figure 1.1, this research focuses on observing the paper production process in finding a suitable alternative to the ones sold on the market. The researchers decided to show the two main processes available, namely manufactured and homemade. With the homemade process being the focal point, fruit waste from winter squash, scientifically called *Cucurbita moschata* Duch., was used to create the alternative paper. The fruit peels of the winter squash were chosen as the paper’s main component as it is biodegradable and locally produced, inexpensive, and accessible. Furthermore, winter squash peels contain cellulose and holocellulose, which are rich in fiber.

1. 5 Significance of the Study

The independent variable, winter squash fruit peels, was referred to as the essential fruit component the researchers utilized to create homemade paper. The dependent variable, viable and stable paper, was referred to as the goal end product of the whole procedure. Intervening variables, such as the paper production process, were controlled following previous studies to ensure the reliability of the research.

1. 6 Scope and Limitations

The study focused on the *Cucurbita moschata* Duch. (winter squash) that is locally available in the Philippines. To provide solutions to the Sustainable Development Goal number 12, Responsible Consumption and Production, as stated by the United Nations (2015), the researchers limited the scope to the winter squash peels. In highlighting the utilization of winter squash peels to create a paper alternative, the main argument that food waste has different and better purposes was shown.

2. METHODOLOGY

2. 1 Prototype Construction

The research utilized the following items: measuring cups, winter squash, assorted shredded recycled paper, blender, paper mold (silkscreen), and a large basin.

The first step was to blend two grams of winter squash and ½ cup of water for one-two minutes or until the winter squash was completely dissolved. Second, the mixture was poured into a bowl. Next, one cup of paper and one cup of water were blended until the form dissolved. Then, another cup of paper and ½ cup of water was incorporated until the paper broke down. After that, the winter squash mix was added and blended with everything for one to two minutes. The final mixture was poured into a large basin and, using a silkscreen, submerged into the mix. Last, it was taken out to dry.

3. DATA ANALYSIS

3.1 The Tensile Strength of Squash Peel Paper

Table 3.A Amount of Weight the Paper Can Withstand Without Breaking Apart

Trial Paper	Distance of the Paper (inches)	Number of Folds	Amount of Weight it can Handle (g)	Tensile Strength
1	6.5	2	64	10.81 Pa
2	6.5	3	13	2.07 Pa
3	6.5	2	26	4.14 Pa
4	6.5	2	20	3.18 Pa
5	6.5	0	32	5.09 Pa
				Mean: 5.06 Pa

The tensile strength of paper is the maximum amount of force it can withstand without tearing apart. To test the tensile strength of the paper, the assigned researcher placed the paper on top of two identical containers with a constant 6.5-inch distance in between. Through repeated experimentation, the researchers were able to gather the data shown in Table 3.A. Since the experiment was done only at home, the researchers cannot guarantee the accuracy of the data.



Figure 3.1 *The Testing of Tensile Strength*

The tensile strength of the paper was measured as the force divided by its area. The area of the paper is a constant of 8.5 inches by 11 inches, which in SI units is 0.26 meters by 0.28 meters since that was the size of the silkscreen where the paper was made. The force was measured by multiplying the mass it can handle by the acceleration due to gravity. Below were the computations.

$$s_1 = \frac{(64 \text{ g})(9.8 \frac{\text{m}}{\text{s}^2})}{(0.22 \text{ m})(0.28 \text{ m})} \quad s_2 = \frac{(13 \text{ g})(9.8 \frac{\text{m}}{\text{s}^2})}{(0.22 \text{ m})(0.28 \text{ m})} \quad s_3 = \frac{(26 \text{ g})(9.8 \frac{\text{m}}{\text{s}^2})}{(0.22 \text{ m})(0.28 \text{ m})}$$

$$s_1 = 10\,181 \text{ mPa} \quad s_2 = 2\,068 \text{ mPa} \quad s_3 = 4\,136 \text{ mPa}$$

$$s_1 = 10.18 \text{ Pa} \quad s_2 = 2.07 \text{ Pa} \quad s_3 = 4.14 \text{ Pa}$$

$$s_4 = \frac{(20 \text{ g})(9.8 \frac{\text{m}}{\text{s}^2})}{(0.22 \text{ m})(0.28 \text{ m})} \quad s_5 = \frac{(32 \text{ g})(9.8 \frac{\text{m}}{\text{s}^2})}{(0.22 \text{ m})(0.28 \text{ m})}$$

$$s_4 = 3\,181 \text{ mPa} \quad s_5 = 5\,090 \text{ mPa}$$

$$s_4 = 3.18 \text{ Pa} \quad s_5 = 5.09 \text{ Pa}$$

3. 2 The Durability of Squash Peel Paper

Table 3.B *The Number of Trials the Paper Withstood*

Trial Paper	Number of Trials being Written	Number of Times before it Tore
1	3	2
2	8	8
3	11	10
4	9	8
5	9	8
		Mean: 7.2

The durability of the paper is the ability to withstand pressure or damage. Using a pencil and eraser to create multiple erasures on each paper, the researchers found out how durable the papers were with how many times each paper could endure being erased in the same spot numerous times. After a repeated number of trials, the researchers gathered data written in Table 3.b from the experiment. Due to the limited number of papers used, the accuracy of the data collected is not guaranteed.



Figure 3.2 *The Scratch Test of the Paper*

3. 3 The Biodegradability of Squash Peel Paper

Table 3.C *Comparison of Paper Mass After Soil Burial*

Trial Paper	Mass Before (g)	Mass After 10 Days (g)
1	0.0045	0.0043
2	0.0036	0.0032
3	0.0051	0.0050
4	0.0073	0.0071
5	0.0039	0.0039
TOTAL: 5	Mean: 0.00488	Mean: 0.0047

According to Goswami & O'Haire (2016), biodegradability is the ability of a substance to degrade after interaction with biological substances. In this experiment, the researchers weighed the squash peel paper before and after being buried in the soil for over ten days. Due to the short amount of time



it was buried, the researchers did not see any substantial difference in the weight of the paper to conclude any biodegradation.

3. 4 Squash Peels as an Effective Component of Paper

Winter squash or *Cucurbita moschata* Duch. was used in the experiment to assess the effectiveness of the peels as a substitute ingredient for paper.

The pulp had a thick consistency and, mixed with the recycled paper, made a very effective pulp mixture. After the pulp was left to dry with the silkscreen in the sun, it became very sturdy and rigid. The results above showed that the prototype paper could not endure the amount of force. The paper did not pass the durability test. Also, evidence from a ten-day biodegradability test showed no change and insufficient evidence. Thus, the prototype passed the tensile strength test but did not pass the durability or biodegradability tests.

4. CONCLUSIONS

4.1. Conclusions

After conducting different testing procedures, particularly regarding the paper's effectiveness, tensile strength, durability, and biodegradability, the initial hypothesis of the research is not entirely accurate. The mixture obtained from the chosen ingredients was thick enough to be molded into the paper. However, it was not a practical alternative based on all three standards. With the testing of the paper's approximate ability to handle a certain amount of force and withstand tear, the paper was able to pass the test for tensile strength. Nevertheless, the paper's inability to resist progressive damages determined its durability to be below expected standards. Lack of adequate time was the main reason the research's biodegradability test had no substantial result. Therefore, the data gathered may not be reliable.

4.2 Summary

Through rigorous research and investigation of the initial research inquiries, the hypothesis that *Cucurbita moschata* Duch. (winter squash) fruit peels could be utilized as a viable component of paper was found to be inaccurate and false. In gathering data through the different testing procedures, the produced paper's tensile strength, durability, and biodegradability were not adequate to be used similarly to standard paper. Thus, this proved the whole research process to be unsuccessful.

4.3 Limitations

Due to the pandemic, the research was limited to being conducted within the homes of each researcher. Since the testing procedures were done in different research environments, the data from each experiment may not be as reliable as having the same research environment throughout. Moreover, the lack of proper laboratory equipment and measuring devices hindered the researchers from obtaining more accurate data. Therefore, the researchers had to utilize simple testing procedures to be quickly done within their homes.

4.4 Recommendations

It is recommended that the testing procedures be done within the same environment to rule out miscellaneous variables that may affect the experiment results. Furthermore, it is advised to utilize proper laboratory equipment and measuring devices to ensure the reliability of the data collected from the procedures. The usage of other abundant crops with more fiber and cellulose content could also be considered for its strengthening properties. If the researchers cannot follow the recommendations above, getting additional guidance and insight from professionals with expertise in the chosen field of research are recommended.

4.5 Implications

The overall result of the research can benefit future research conducted within the same field. The testing procedures and data collection process can be modified to create a variety of paper utilizing locally available fruit peels, waste, and other fibrous alternatives to wood fiber. In creating this end-paper, the researchers were able to recycle previously used paper and household waste products to emphasize the importance of the trees in the environment and aid in the minimization of waste. This concept subsequently contributes to the well-being of the whole community and improves the state of waste management.

5. ACKNOWLEDGMENTS

First and foremost, we would like to thank the Lord our God for the safety He provided for us amidst the global pandemic. Through His protection, we pursued our research endeavors and slowly contributed to a waste-free community and world.

We would also like to extend our most sincere gratitude to our family, particularly our parents, for giving us financial support and allowing us to purchase the necessary research materials online. Through their endless love and support, we were able to perform our research experiment and smoothly test our hypothesis.

Last but not least, this research would not



have been possible without the support and guidance of our Inquiries, Investigations, and Immersion subject teacher, Mr. Lodeo Pascual, and our research advisors, Mr. Kevin Villarico and Mr. Nico Bravo. Their insights and expertise in the scientific field significantly contributed to and improved the overall state of this research project.

6. REFERENCES

- Aithal, S. (2016,). A study on history of paper and possible paper free world. ResearchGate.
https://www.researchgate.net/publication/291486327_A_Study_on_History_of_Paper_and_possible_Paper_Free_World
- Augustyn, A. (2020). Tensile strength | Definition, unit, & facts. Encyclopedia Britannica.
<https://www.britannica.com/science/tensile-strength>.
- Bajpai P. (2015) Basic overview of pulp and paper manufacturing process. In: Green Chemistry and Sustainability in Pulp and Paper Industry. Springer, Cham. https://doi.org/10.1007/978-3-319-18744-0_2
- Bloom, J. (2017,). Papermaking: The historical diffusion of an ancient technique. Springer Link.
https://link.springer.com/chapter/10.1007/978-3-319-44654-7_3
- Caulfield, D., & Gunderson, D. (1998). Paper testing and strength characteristics. Tappi Press.
<https://www.fpl.fs.fed.us/documnts/pdf1988/caulf88b.pdf>
- Castillo, A., & Otoma, S. (2013). Status of solid waste management in the Philippines. [University of Kitakyushu, Japan].
https://www.jstage.jst.go.jp/article/jsmcwm/24/0/24_677/_pdf#:~:text=About%2035%2C580%20tons%20of%20garbage,urban%20and%20rural%20areas%2C%20respectively
- David, A., Thangavel, Y., & Sankriti, R. (2019). Recover, recycle and reuse: An efficient way to reduce the waste. ResearchGate.
https://www.researchgate.net/publication/332444076_Recover_Recycle_and_Reuse_An_Efficient_Way_to_Reduce_the_Waste
- Dimensional Stability. (n.d.). PrintWiki.
http://printwiki.org/Dimensional_Stability.
- Garcia, G., Rahimifard, S., Colwill, J., White, R., & Needham, L. (1970). A methodology for sustainable management of food waste. Springer Link.
<https://link.springer.com/article/10.1007/s12649-016-9720-0>
- Goswami, P., & O'Haire, T. (2016). Developments in the use of green (biodegradable), recycled and biopolymer materials in technical nonwovens. ScienceDirect.
<https://www.sciencedirect.com/science/article/pii/B978081005750000036>.
- Henry, P. (n.d.). Paper characteristics: calendering, basis weight, caliper, bulk. New York City College of Technology: Department of Advertising Arts and Graphic Design.
<http://websupport1.citytech.cuny.edu/faculty/pheny/papercharii.html>.
- Jacobo-Valenzuela, N., Zazueta-Morales, J., Gallegos-Infante, J., Aguilar-Gutierrez, F., Camacho-Hernández, I., Rocha-Guzman, N., & Gonzalez-Laredo, R. (2011). Chemical and physicochemical characterization of Winter Squash (*Cucurbita moschata* D.). [Academic dissertation, Universidad Autónoma de Sinaloa].
<https://www.notulaeobotanicae.ro/index.php/nbha/article/view/5848/5577>.
- Limon, M., & Villarino, C. (2020). Knowledge, attitudes and practices on household food waste: Bases for formulation of a recycling system. Global Journal of Environmental Science and Management.
https://www.gjesm.net/article_38212_5a9fd49de34b4324fbaec3aba850e825.pdf
- Leigh, E. (n.d.). How can we make banana peelings into paper? SF Gate. Retrieved from
<https://homeguides.sfgate.com/can-make-banana-peelings-paper-79259.html>.
- OECD. (2016). Safety assessment of transgenic organisms in the environment, Volume 5. https://read.oecd-ilibrary.org/environment/safety-assessment-of-transgenic-organisms-in-the-environment-volume-5_9789264253018-en#page4.
- Quintana, S., Marsiglia, R., Machacon, D., Torregroza, E., & García-Zapateiro, L. (2018). Chemical composition and physicochemical properties of squash (*Cucurbita moschata*) cultivated in Bolivar department (Colombia). Pdfs.semanticscholar.org.
https://pdfs.semanticscholar.org/5d36/f39880fd3a4281b1303b9b67357baf11aa9.pdf?_ga=2.54982699.1870330047.1598936515-1369805077.1598936515.
- Sagar, N., Pareek, S., Sharma, S., Yahia, E. M., & Lobo, M. (2018). Fruit and vegetable waste: bioactive compounds, their extraction, and possible utilization. Wiley Online Library.
<https://onlinelibrary.wiley.com/doi/full/10.1111/1541-4337.12330>
- Science Buddies. (2013). Recycling science: test biodegradable products in an indoor composter. Scientific American.
<https://www.scientificamerican.com/article/bring-science-home-biodegradable-products/>.
- Taha, N., El-Maghraby, A., Elkady, M., & El-Hamied, M. (2010). Beneficial reuse of waste products. ResearchGate.
https://www.researchgate.net/publication/303464524_Beneficial_reuse_of_waste_products
- Tatel, M. (2018, August). Amylum and Citrus uranium L peeling: Utilizing into homemade paper. ResearchGate.
https://www.researchgate.net/publication/327175614_Amylum_and_Citrus_aurantium_L_peeling_Utilizing_in_to_homemade_paper
- Tepper, L. (2013). Squash Production Guide. Department of Agriculture Bureau of Plant Industry. Retrieved 16 April 2021, from
http://bpi.da.gov.ph/bpi/images/Production_guide/pdf/PRODUCTIONGUIDE-SQUASH.pdf.
- The World Counts. (2020).
<https://www.theworldcounts.com/challenges/consumption/other-products/environmental-impact-of-paper/story>
- The 7 most common types of paper (2020). Guarro Casas.
<https://guarrocasas.com/en/paper-academy/7-most-common-types-paper>.
- Trends in Solid Waste Management. (2016). The World Bank. https://datatopics.worldbank.org/what-a-waste/trends_in_solid_waste_management.html#:~:text=



3RD DLSU SENIOR HIGH SCHOOL RESEARCH CONGRESS

2020-2021

MATERIALS ENGINEERING

t=The%20world%20generates%202.01%20billion,from
%200.11%20to%204.54%20kilograms.

United Nations. (2015). THE 17 GOALS | Sustainable Development. Sdgs.un.org. Retrieved 16 April 2021, from <https://sdgs.un.org/goals>.

Van Der Reyden, D. (1992). Recent scientific research in paper conservation. Journal of the American Institute for Conversation, Volume 31, Number 1, Article 14 (pp. 117 to 138).
https://cool.culturalheritage.org/jaic/articles/jaic31-01-014_2.html#:~:text=Physical%20properties%20of%20paper%20sheets,Casey%201980%3B%20Bolam%201962).

Venelampi, O., Weber, A., Ronkko, T., & Itavaara, M. (2013). The biodegradation and disintegration of paper products in the composting environment. Taylor & Francis.
<https://www.tandfonline.com/doi/abs/10.1080/1065657X.2003.10702128>.

Worland, J. (2015). Here's how many trees humans cut down each year. Time. <https://time.com/4019277/trees-humans-deforestation/>



Design and Analysis of a Face Mask Alternative

Dane Marcus A. Chan, Ken Sean D. Roque, Chloe S. Sia
and Francine Joie N. Tiu

Saint Jude Catholic School, Manila

Abstract: Due to the recent pandemic that plagued the country, face mask disposal has gained considerable attention. If something similar were to happen again, the creation of an alternative to the medically approved surgical masks is crucial to minimize disease spread induced by improper face mask disposal. This study aims to analyze and determine the proposed output's effectiveness compared to conventional face masks. The materials for the trilayer output were nylon, paper towel, and cotton. The produced output and the control sample, the standard cloth mask, were sent to a lab for water resistance and absorbency tests. The test results revealed that neither the produced output nor the cloth mask could meet the recommended standards of a good face mask. As such, this research concluded that the production of an alternative face mask using the materials stated above in a manner identical to that of this study is ill-advisable. Additionally, the study affirmed that the standard cloth masks are not suitable as an efficient alternative to surgical masks. Overall, the paper intends to contribute to solving two of the United Nations' Sustainable Development Goals (SDG), which are (3) Good and Health Well-being and (12) Responsible Consumption and Production.

Key Words: face mask; alternative; resistance; absorbency; substitute

1. INTRODUCTION

Given the rapid spread of COVID-19 cases globally, the community's active population must use efficient face masks to mitigate virus transmissions. In a study conducted by Cheng (2020), countries with high compliance with face mask usage, such as Hong Kong (96.6%), have lower cases within the first 100 days of the virus exposure. From this, it can be concluded that community-wide mask-wearing has an inverse relationship with the number of transmissions.

As face masks have been proven to be an effective measure in preventing transmissions, Wu (2020) adds that the usage of face masks has become the global norm. With this in mind, billions of face masks have been produced and used yearly by various countries. Taiwan has consumed 1.3 billion surgical masks in one year. Sangkham (2020) also cites that each person in the general population used one face mask each day. On that note, improper disposal of infectious wastes, such as used face masks, may negatively impact both health and environment-related aspects.

To combat this problem, identifying sustainable and easily accessible materials for face mask alternatives is of great significance to the community. Thus, the researchers aim to create a better community face mask alternative in place of cloth masks by having it tested by laboratory professionals. Moreover, the study intends to assess,

analyze, and determine the produced output's effectiveness compared to conventional face masks.

The materials for the output were nylon fabric, paper towels, and cotton. These materials were utilized based on determined criteria and accessibility in the perspective of an ordinary Filipino. In this manner, the researchers conducted tests to examine their efficacy in resisting water, preventing the entry of bacteria, and exhibiting comfortability.

2. REVIEW OF RELATED LITERATURE

The production of a community mask alternative with comparable effectiveness calls for being equipped with prior knowledge on related studies. Consequently, the researchers explored trusted sources to gain useful supporting information on the topic.

In his study, Cheng (2020) proved that community-wide mask-wearing has an inverse relationship with the number of transmissions. Countries with high compliance with face mask usage have significantly lower cases than those with low compliance. In this manner, the number of COVID-19 cases can be mitigated (Guan, 2020).

Unfortunately, a multitude of studies deals with existing face mask alternatives and their efficiency. Still, only a few were able to tackle the actual materials used for different types of masks. It is crucial that we further investigate the effectiveness of such materials. Likewise, understanding the



scientific properties behind the materials of existing face masks shall lead the researchers to identify critical points for alternative face mask production. Apart from this, studies related to suggested face mask homemade alternatives were considered. This is crucial as Khazan (2020) claims that people's daily activities will include face masks as necessities for a long time due to the pandemic.

Lastly, elaborating different processes of contamination measurement through valid sources led to helpful knowledge to create a scientifically accurate and acceptable experimental design to test the researchers' output.

As for the materials to be tested, common household materials that observe excellent filtration efficacy, particularly coffee filters and vacuum cleaner bags, were selected. Moreover, a study conducted by Davies (2013) suggests using breathable materials such as cotton and silk.

In the context of nylon fabric, Godoy (2020) claims that research suggests that adding an outer layer of nylon fabric to a homemade cloth face mask can increase its filtration efficiency. Accordingly, layers can potentially make the pre-made face mask comparatively similar to surgical masks.

According to Mayo Clinic (2019), cotton-made cloth masks are intended to trap droplets released from the wearer's mouth while observing superiority in terms of comfortability. In this manner, these masks can reduce the spread of external agents and viruses without compromising the wearer's comfort. Moreover, cloth face coverings are easily accessible by the community. These masks can also be easily rewashed and reused.

On the other hand, a single sheet of paper towels shows an unpromising 23% 0.03 micron particle blockage after a test by Robertson (2020), which adds 10% for an additional layer. However, Parker-Pope (2020) from The New York Times asserted that inserting a paper towel in the middle of two fabrics can make the mask more efficient and effective.

3. METHODOLOGY

In this study, data was collected through laboratory testing protocols. A prototype of the proposed output and a standard commercial cotton mask were sent to Intertek Laboratories for experimentation. Licensed laboratory professionals conducted the tests to determine how efficient each face mask performs, given the criteria.

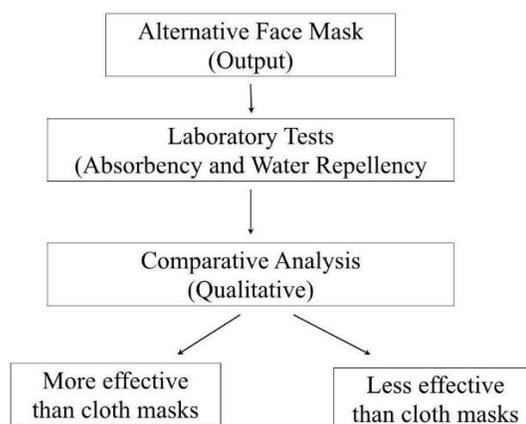

3.1 Absorbency

The data gathered for the face masks' performance in absorbency was obtained through an Absorbency Test (AATCC 79). As stated by the American Association of Textile Chemists and Colorists (2018), this test method applies to any textile fabric as it determines its water absorbency. Therefore, it is suitable for measuring and comparing the two face masks' absorbency to gauge how they minimize skin moisture and facilitate sweat evaporation.

In this test, a drop of water was allowed to fall from a fixed height onto the fabrics' surface. Moreover, the time taken for the water drop to disappear and evaporate was measured and recorded as wetting time.

3.2 Water Resistance

The data gathered for the face masks' performance regarding water resistance was obtained through a Water Repellency Test (AATCC 22), also known as Spray Test. As stated by the American Association of Textile Chemists and Colorists (2017), this test applies to any textile fabric, as it measures its overall resistance to wetting by water. Therefore, it is suitable for measuring and comparing the water-repellent efficacy of the two face masks.

In this test, water was sprayed against the fabric surface under controlled conditions. This, in turn, produced a wetted pattern whose size varies based on the fabrics' relative repellency. Upon doing so, the wetted pattern was compared with pictures on a standard chart for further evaluation.

4. DATA AND RESULTS

Item Description	: Two (2) submitted mask marked as: (A) woven in white with green embroidery (outer side) and white pique (inner side) with 6 white panels (B) knitted in black with red print (outer side), white (inner side) with 3 white panels.
Date Received/Date Test Started	: 17 November 2020
Fiber Content	:
Color	: (A)White, (B)Black
Order No.	:
Article No.	:
Style No.	:

Based on the results shown above, both the experimental group (A) and the control group (B) failed to meet the standard in terms of water repellency. As the required remark is 70, which involves a partial wetting of the specimen face beyond the spray points, both groups (A and B) had 0 remarks due to their complete wetting upon testing. In the said experiment, three trials were conducted on both A and B. However, the results remained constant at 0. This means that the percent error of both samples is at 100%.

Moreover, the results show that the produced output (A) did not have water resistance levels more than or equal to standard cloth masks.

Water Repellency Absorbency Test	(A) F**	(B) F**
	F**	F**

Note:
P = Passed the Commercially Acceptable Requirement.
F* = Failed the Commercially Acceptable Requirement.
= No Specified Requirement.
MI = Meet the Submitted Requirement. F1 = Below the Submitted Requirement.
M = Meet Buyer's Requirement. F = Below Buyer's Requirement.

1. Water Repellency		(A)	(B)	Requirement
AATCC TM22-2017e		Outer Side	Outer Side	
Rating	Trial 1	0	0	70
	Trial 2	0	0	70
	Trial 3	0	0	70

REMARK:
Tested on Panels

Legend:
100 = No sticking or wetting of the specimen face
90 = Slight random sticking or wetting of the specimen face
80 = Wetting of specimen face at spray points
70 = Partial wetting of the specimen face beyond the spray points
50 = Complete wetting of the entire specimen face beyond the spray points
0 = Complete wetting of the entire face of the specimen

The results acquired from the laboratory in the context of absorbency show unsatisfactory results. The standard for water absorbency was not met; additionally, the control test results were shown to be much closer to the standard than the produced output. The produced output falls short of both the control group or the generic cloth mask and the recommended standards in terms of water absorption.

To expound better, the water absorbency in this test was measured in terms of time, wherein the amount of time (in seconds) it takes for the fabric to absorb a particular volume of water was measured. The time it took for the cloth mask and the produced output to absorb water was eight seconds and more than 60 seconds, respectively. This means given the required time is five seconds, the control had a percent error of 60%. Meanwhile, the produced output had a minimum percent error of approximately 1100%.

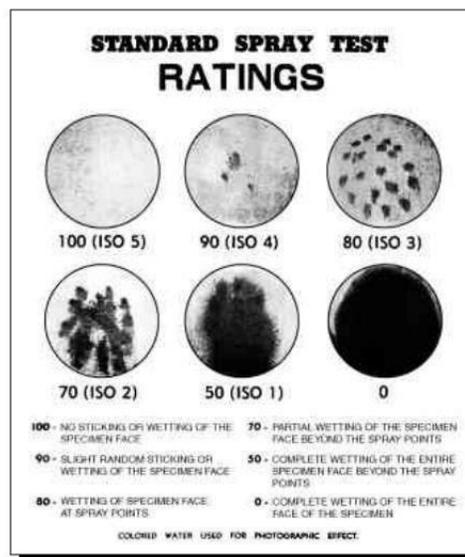

Fig. 1—Spray test rating chart.

2. Absorbency Test		(A)	(B)	Requirement
AATCC TM79-2016e2(2018)e		Inner Side	Outer Side	
		60 + s	8 s	≤5 s

REMARK:
s = seconds
Tested on Panels

5. CONCLUSIONS AND RECOMMENDATIONS

The study has concluded that the produced output is, in fact, less efficient than the standard cloth mask as a whole. The produced output falls short of the standards put together by the World Health Organization (WHO) and the properties of the cloth mask found in markets. As such, the materials used in producing the output—the nylon, the tissue paper, and the cotton—are ill-advised to be used, or at least to be used in the same manner as that in the study to produce an effective alternative face mask.

Given that the output could not be tested with certain criteria, such as filtration efficiency, flammability, and air permeability, which is crucial for a face mask, future researchers must consider this. It is necessary as these specific criteria are firm fundamentals for the effectiveness of a face mask. Additionally, it is also advisable for the manner of testing to be conducted by future studies to be more systematic and reliable than the method done in this study. A more reliable way of conducting the research would have been to test multiple samples of varying materials one by one and then produce an output, which would also be tested based on the results.

Moreover, citizens must be advised that commercially available cloth masks also performed poorly in the test. In conclusion, surgical masks are still the best option.



6. ACKNOWLEDGMENTS

The researchers would like to express their deepest gratitude to their research teacher, Mr. Kevin G. Villarico, for guiding them along the way and making this study possible. Moreover, the researchers would like to thank Intertek Laboratories for the opportunity to have their samples tested, especially Mr. Manthy Cantillo and Ms. Kim Caceres, for supervising the procedure and addressing their inquiries. The researchers would also like to thank their families and friends for their encouragement and financial support amidst the ongoing pandemic. Last but not least, to God for His continuous guidance.

7. REFERENCES

- AATCC 22 Water repellency: Spray test. (2017). AATCC. Retrieved from members.aatcc.org/store/tm22/487
- AATCC 79 Absorbency of textiles. (2018). AATCC. Retrieved from members.aatcc.org/store/tm79/499
- Advice on the use of masks in the community, during home care and in healthcare settings in the context of the novel coronavirus (COVID-19) outbreak. (n.d.). Retrieved from [https://www.who.int/publications/i/item/advice-on-the-use-of-masks-in-the-community-during-home-care-and-in-healthcare-settings-in-the-context-of-the-novel-coronavirus-\(2019-ncov\)-outbreak](https://www.who.int/publications/i/item/advice-on-the-use-of-masks-in-the-community-during-home-care-and-in-healthcare-settings-in-the-context-of-the-novel-coronavirus-(2019-ncov)-outbreak)
- ASTM D737-96 Air permeability: Standard test method for Air Permeability of Textile Fabrics. (2018). CSBS. Retrieved from csbs.uni.edu/sites/default/files/Air_Permeability.pdf
- Bacterial & Viral Filtration Efficiency Tests. (2020, February 04). Retrieved from <https://www.nelsonlabs.com/testing/bacterial-viral-filtration-efficiency-bfe-vfe/>
- Belkin, N. (2015). The evolution of the surgical mask: Filtering efficiency versus effectiveness. *Infection Control and Hospital Epidemiology*, 18(1), 49-57.
- Bilek, P., & Sidlof, P. (2013). Measuring of filtration efficiency of nonwoven textiles in volume from scattered light by seeding particles. *EPJ Web of Conferences*, 45, 01014. doi:10.1051/epjconf/20134501014
- Cheng, V. (2020). The role of community-wide wearing of face mask for control of coronavirus disease 2019 (COVID-19) epidemic due to SARS-CoV-2. *Journal of Infection*, 81(1), 107-104.
- Chua, M. H., Cheng, W., Goh, S. S., Kong, J., Li, B., Lim, J. Y., . . . Loh, X. J. (2020, August 07). Face Masks in the New COVID-19 Normal: Materials, Testing, and Perspectives. Retrieved from <https://spj.sciencemag.org/journals/research/2020/7286735/>
- Davies, A., Thompson, K., Giri, K., Kafatos, G., Walker, J., & Bennett, A. (2013). Testing the Efficacy of Homemade Masks: Would They Protect in an Influenza Pandemic? *Disaster Medicine and Public Health Preparedness*, 7(4), 413-418. doi:10.1017/dmp.2013.4
- Department Of Anesthesiology College Of Medicine University Of Florida. 2020. Mask Alternative. [online] Available at: <https://anest.ufl.edu/clinical-divisions/mask-alternative/>
- Esposito, S., Principi, N., Leung, C. and Migliori, G., 2020. Universal use of face masks for success against COVID-19: evidence and implications for prevention policies. *European Respiratory Journal*, [online] 55(6), p.2001260. Available at: <http://dx.doi.org/10.1183/13993003.01260-2020>
- Fischer, E. P., Fischer, M. C., Grass, D., Henrion, I., Warren, W. S., & Westman, E. (2020, September 01). Low-cost measurement of face mask efficacy for filtering expelled droplets during speech. Retrieved from <https://advances.sciencemag.org/content/6/36/eabd308>
- Godoy, M. (2020, April 22). Adding A Nylon Stocking Layer Could Boost Protection From Cloth Masks, Study Finds. Retrieved from <https://www.npr.org/sections/goatsandsoda/2020/04/22/840146830/adding-a-nylon-stocking-layer-could-boost-protection-from-cloth-masks-study-find>
- Guan, W. (2020). Clinical characteristics of coronavirus disease in China. *The New England Journal of Medicine*.
- Howard, J. (2020). Face masks against COVID-19: An evidence review. *Preprints*, 1(1).
- Joshi, M., Khan, A., & Sapra, B. K. (2020). Quick laboratory methodology for determining the effectiveness of face mask respirators in the wake of COVID-19 pandemic. doi:10.21203/rs.3.rs-32527/v
- Mayo Clinic. 2020. Can Face Masks Protect Against The Coronavirus?. [online] Available at: <https://www.mayoclinic.org/diseases-conditions/coronavirus/in-depth/coronavirus-mask/art-20485449>
- Micron. (2014). Tech Terms. Retrieved from <https://techterms.com/definition/micron>
- Miller, A. M. (2020, August 11). WHO: Fabric masks need 3 layers to best curb coronavirus spread. Retrieved from <https://www.businessinsider.com/who-fabric-masks-need-3-layers-to-curb-coronavirus-spread-2020-6>
- Norton, K. (2019, March 02). Why Is Cotton Absorbent? Retrieved from <https://sciencing.com/cotton-absorbent-6662538.html>
- Parker-Pope, T., 2020. What's The Best Material For A Mask?. [online] *Nytimes.com*. Available at: <https://www.nytimes.com/article/coronavirus-homemade-mask-material-DIY-face-mask-ppe.html>
- Philips, B. (1992). Surgical face masks are effective in reducing bacterial contamination caused by dispersal from the upper airway. *British Journal of Anaesthesia*, 69(4), 407-408.
- Qisheng, O. (2020). Evaluation of decontamination methods for commercial and alternative respirator and mask materials. *Journal of Aerosol Science*, 150(1).
- Reusability of Facemasks During an Influenza Pandemic. (2006). doi:10.17226/11637
- Sangkam, S. (2020). Face mask and medical waste disposal during the novel COVID-19 pandemic in Asia. *Case Studies in Chemical and Environmental Engineering*
- Sickbert-Bennett, E. E., Samet, J. M., Clapp, P. W., Chen, H., Berntsen, J., Zeman, K. L., . . . Bennett, W. D. (2020). Filtration Efficiency of Hospital Face Mask Alternatives Available for Use During the COVID-19 Pandemic. *JAMA Internal Medicine*. doi:10.1001/jamainternmed.2020.4221
- Standards for Medical Face Masks and Protective Clothing: ASTM Standardization News. (n.d.). Retrieved from <https://www.astm.org/standardization-news/?q=features/standards-medical-face-masks-and-protective-clothing.html>
- Teesing, G. (2020). Is there an adequate alternative to commercially manufactured face masks? A comparison of various materials and forms. *Journal of Hospital Infection*, 106(2), 246-253.



Sino malaya?: Melodrama and the Integration of Contemporary Social Issues in Philippine Independent Films

Maureen Alexandra A. Dungan, Miracle Joyce C. Geronimo, Japheth Sean S. Morales
and Cristen Dominique L. Tantoco
De La Salle University Integrated School, Manila

Abstract: Various film critics have written about the dominant themes found in independent films, such as gender and sexuality, culture, and sociopolitical issues. Independent filmmakers have distinctive ways of portraying these issues. Guided by Pathak (2017)'s framework on melodrama, the researchers chose to use melodramatic conventions and techniques to analyze further how these social issues are portrayed in independent films. Findings found that the independent films used melodramatic conventions in portraying social issues. Analyses showed that (1) the films made use of issues such as family relationships and understanding reality, (2) various cinematic elements were applied in the context of melodrama to deliver the film's message, and (3) setting and physical characteristics were utilized in independent films to display social issues better. This study may be relevant to future research on independent film analysis, the development of national cinema, and the progress of local independent films as a whole.

Key Words: independent films; melodrama; contemporary social issues; Philippine cinema; films

1. INTRODUCTION

To understand the contemporary issues in independent films in the Philippines, the researchers interpreted the issues through analyses of films in the genre. The concepts of what elements are included in the creation of independent films were analyzed. These were essential in understanding the need for these social issues to be addressed and if the future of Philippine cinema would be rooted in the country's troubles. The researchers used Philippine independent films, which are individually funded and produced, with little to no outside regulation that commonly deal with real social issues widely faced by third world countries such as the Philippines (Beng, 2010; Isla, 2010).

1.1. Background of the Study

In the 21st century, films remain one of many individuals' major leisure activities (Heo et al., 2017). Filmmakers and production companies continue generating endless possibilities when creating films. Notably, independent films have been 'breaking the scene' and are contesting movies by major film companies. Independent films are unique in how filmmakers deviate from standard techniques and methods, all amidst a limited production budget and manufacturing staff (Lim, 2019). In the Philippines, independent films have made their way into mainstream cinema, garnering numerous viewers and supporters. The content of these films aid in acquiring

audiences, with the most popular themes being gender and sexuality, culture, and sociopolitical issues. These subjects are essential since independent filmmakers risk tackling more challenging sociopolitical problems to shed light on current, pertinent issues (Bolisay, 2017). Through viewing independent films, audiences obtain new knowledge that sheds light on the present societal situation.

1.2 Statement of the Problem

This research aimed to analyze the content of independent films by answering the following questions:

- What are contemporary social issues commonly portrayed in independent films in the Philippines?
- How do conventions in melodrama influence the portrayal of these contemporary social issues?
- How do cinematic elements work through the portrayal of these issues in independent films?

1.3 Scope and Limitation

The researchers focused on analyzing contemporary social issues in exclusively Philippine independent films, using melodrama conventions and cinematic elements. A thematic analysis was conducted on three independent films from different local filmmakers. The analysis was based on techniques elaborated in Braun and Clarke (2012) and limited to melodramatic scenes and contemporary



social issues found in the films. The data was used to determine similar codes in the movies that eventually led to discovering their respective themes.

1.4 Significance of the Study

Independent films have been rising in recognition throughout the years, providing a platform for filmmakers to explore unconventional ideas, deviating from mainstream media (Bolisay, 2017). Independent films are a way to present social issues in a consumable form, as the discussion and awareness thereof are vital. Moreover, the usage of melodramatic conventions, a common technique used in Filipino media, aids in understanding how independent films with melodrama will contribute to the comprehension of how much of an impact independent films have on society (First, 2008).

The results also established the importance of independent films and the social issues being portrayed. The researchers hope that this study could contribute to the sphere of the arts as a whole.

2. METHODOLOGY

The researchers' methodology made use of Philippine independent films that were showcased in public events. A total of three films were selected from two different directors, which all contained various social issues present in the Philippines. Then, data was gathered from these films and were analyzed using the thematic analysis method of Braun and Clarke (2012).

2.1 Films Analyzed

In selecting the films to be analyzed, the researchers chose those presented in public film festivals like Cinemalaya. According to Bolisay (2017), the increase of such events that offer screening venues led to a similar increase in independent films, which is why the researchers chose this as a selection criteria. They sent request emails to local independent filmmakers who had films that fit this criterion. Given that some were unresponsive, the researchers looked for alternative sources such as legal streaming sites. Once the list of films was finalized, the director, synopses, and initial social issues were tabulated as a guide.

2.2 Data Analysis

The researchers used Braun and Clarke's (2012) thematic analysis method in interpreting the data that came from the movie analyses. They identified common ideas and patterns evident in the films and distributed them into codes per individual film. These codes were categorized into general themes based on their similar characteristics.

Afterward, the research questions were answered using the themes that were collected.

3. RESULTS AND DISCUSSIONS

Four still images from each of the three movies, *Transit* by Hannah Espia, *Lola Igna* and *Pamilya Ordinaryo* both by Eduardo Roy Jr., were collected by the researchers to provide scenes that both utilize melodramatic conventions as well as portray the social issues presented by the film.

3.1 Lola Igna

Lola Igna portrayed themes and issues through various cinematic elements and melodramatic methods, such as landscape and positioning as narrative tools. The slow scene pacing and the use of natural sounds presented the simple provincial life of the main character. On the other hand, the camera movement was also manipulated for symbolisms. Contrasting static shots and "vlog" shots were utilized to portray the degree of connection certain characters and the audience had with the title character.

Symbolisms were also evident in dialogue, *mise-en-scène* and cinematography. This was showcased in the use of language variation to portray *Lola Igna's* opening to new experiences, the placement of insects to show the theme of death, and the penultimate final shot that represented both the life and newfound resolve of the title character.

3.2 Pamilya Ordinaryo

Pamilya Ordinaryo depicted the lifestyle of the Filipino poor and focused on the reality of living as beggars and their treatment in society. The film portrayed the realities that the poor have to deal with, such as maltreatment by members of the sectors of society, the higher tendency of drug abuse, and the need to live for survival.

Melodrama was implemented to create a connection of empathy between the audience and the characters, showing the side commonly known by most and the struggles faced by the *Ordinaryo* family and, in turn, the poor in the Philippines.

The ambiance of the shots used no filtering to glamorize the scenes; instead, it used background noise and realistic settings to depict the scenarios familiar to viewers. As seen in the still images, the dialogue was manipulated, often taking advantage of the silence or carefully chosen words to portray the emotions the characters feel in that moment. This movie effectively used the tools of melodrama to show what life was like for those in poverty and captured the audience's attention, raising awareness of the difficulty of surviving every day and changing how one perceives a beggar on the street.



3.3 Transit

Transit is a film that showcases the vast experiences of both OFWs and their children working in foreign lands. Most scenes used close-up to half-body shots, which followed each of the different storylines. Throughout most of the film, each scene was filmed with many gray tones, resembling bleak situations. The film utilized the different perspectives of the main characters to add new information and views regarding the issue.

The film allowed the audience to better understand the problems faced by OFW communities and learn more about the specific issue of deportation in Israel as both had significance to the nation's culture and economy. The children could not fully identify with their Filipino heritage due to the vast difference in their upbringing while also being unable to identify with the Israeli society due to their ethnicity. The adults also dealt with the deportation problems. These characters were being rejected by the country they were in while also leaving the hardship they would have on their return, which is a commentary on the country's labor quality.

3.4 Discussion

Based on the preliminary analyses of the still images, these scenes were categorized into different codes used to determine dominant themes according to each research question.

3.4.1. Social Issues

The themes of family relationships and understanding reality were drawn. First, the narrative of the films revolved around families. Lola Igna showed how her provincial family affected her everyday life and will to live. Pamilya Ordinaryo followed the daily struggles of a poor teenage family. Meanwhile, Transit explored the living conditions of illegal immigrant families. These films emphasized their dynamics and how they dealt with the problems they faced.

The family structures and relationships presented were in contrast with mainstream media's norms. Clark (2008) described American family movies as "middle-class, Caucasian, dual or single-parent family with one or two children" (p. 85). The chosen films deviated from this concept of family. Families in different settings, different classes, and different problems from the image customarily portrayed were seen in all films.

In line with this, realism was quite evident in the films analyzed. Unlike mainstream media, these independent films showcased realistic living conditions and stories. Zurcher, et al. (2018) discussed that many mainstream films portrayed families in positive environments. Despite promoting good family relationships, these lack in reality. The films chosen

not only showed real family conflicts but also individual journeys. The characters had to come to terms with the purpose of life, power imbalance between classes, and realistic consequences of their actions. These independent movies delved into issues and topics ignored by mainstream media.

3.4.2. Melodrama Conventions

Melodramatic conventions were utilized by presenting situations relating to the audience and drawing emotion through symbolism. With the filmmakers giving environments familiarity, a connection and empathy was formed between the characters and viewers. Pamilya Ordinaryo and Lola Igna were set in familiar environments while Transit was shot in unfamiliar Israel, which allowed viewers to see the unique circumstances of characters.

The cinematography in the films utilized the technique of stabilization in filming, with some melodramatic scenes shot in still, wide shots with little movement to portray the filmmaker's intended messages. Point of view helped emphasize who the audience identified with (Håkansson, 2012). There was also a sense of composition in scenes, found by Callenbach (1966) to be one of the critical components of cinematography. This was seen in how Lola Igna and Transit scenes were shot, creating an artistic quality in the scene serving a more profound meaning from the beginning to the end.

Landscapes and color were also important since they changed the film's atmosphere, as seen in the difference from the streets of Manila of Pamilya Ordinaryo to the province of Lola Igna, and even urban Israel in Transit. The dark colors of Pamilya Ordinaryo and Transit to Lola Igna's cheerful and natural elements, allowed the audience to become a part of the story.

Symbolism was also a key melodramatic element. Bakony (1974) asserts that symbols are the combined conscious and unconscious associations by the viewer. The films utilized multiple visual and verbal symbols that portray deeper messages, as independent films place importance in storytelling to deliver their stances.

3.4.3. Cinematic Elements

Drawing from codes cinematic elements were utilized to portray issues by reflecting circumstance in setting and character status in physical characteristics. Though each film showed different circumstances, each film adjusted the portrayal of the settings to fit the movie's theme.

Setting is a primary tool for social issue portrayal in films, allowing filmmakers to introduce themes through character interactions in an environment. Time and place, interact with one another in a film to portray a specific narrative



(Pramaggiore & Wallis, 2005). These settings exposed many previously unknown areas such as the rural Sagada, the slums of Manila, and Filipino housings in Israel. These inform viewers about the characters' lives and form an emotional connection to these places through momentary experience (Frost, 2009). Each film evoked an emotional response through the settings that showcased the characters' contexts and motivations.

The way characters carried themselves through personal adornment or interaction with others also allowed the film to portray their messages. All three films showed characters that lack money to buy clothing, symbolizing the characters' bleak financial status (Batten, 2010). The dialogue between characters also allows viewers to understand the emotional connection between characters and see the different ways of speaking and relatedness among the different groups of people (Azab et al., 2019). Character intimacy was also shown in both dialogue and proximity, allowing viewers to see that the theme of family is prevalent in different circumstances.

4. CONCLUSIONS

The three Philippine independent films analyzed used various cinematic elements and melodramatic conventions to portray their respective social issues. The different types of Filipino family dynamics were depicted, including realistic and flawed characters and situations. When it came to melodramatic conventions, the independent films presented situations with the audience and drew emotion through symbolism. Setting, cinematography, landscapes and color, and symbolism played essential roles in creating a connection with the audience and developing the story. Lastly, the cinematic elements evident in the films were setting to reflect one's circumstance and portrayal of character status through physical characteristics. The characters were defined by their setting and their interaction with other characters.

Through the rising popularity of independent Filipino cinema, filmmakers are given more freedom to express their views on social issues occurring in the country. Their works continuously inspire and motivate audiences nationwide, creating wiser and more knowledgeable audiences. Truthfully, Filipino independent films act as a common ground for both artistic expression and social awareness.

5. ACKNOWLEDGMENTS

Foremost, the researchers thank the Lord for His presence and grace. It is with His guidance that the researchers were given the strength to accomplish this paper.

The researchers would also like to express

their sincerest gratitude to Dr. Anne Richie G. Balgos, who served as their research adviser and mentor, for imparting her knowledge and expertise. She has been the guiding light for the researchers, who never would have reached such achievements with her absence.

Warm thanks to Mr. Christian P. Gopez, the research coordinator for Humanities and Social Sciences Senior High School Department at De La Salle University, for his counsel and direction throughout the entire research process.

The researchers are utterly grateful for their family, friends, and teachers who have been unwavering pillars of strength and support.

Last but not least, this paper would not have been possible without the existence of all independent filmmakers and their craft. In challenging times, they have called the researchers to either find a way or to make their own

6. REFERENCES

- Azab, M., Kojima, N., Deng, J., & Mihalcea, R. (2019). Representing Movie Characters in Dialogues. *Proceedings of the 23rd Conference on Computational Natural Language Learning (CoNLL)*, 99-109. <https://doi.org/10.18653/v1/K19-1010>
- Baker, C. (2014). An intersectional analysis of sex trafficking films. *Meridians*, 12(1), 208-226. <https://doi.org/10.2979/meridians.12.1.208>
- Bakony, E. (1974). Symbolism in the Feature Film. (ED096715), ERIC. <https://files.eric.ed.gov/fulltext/ED096715.pdf>
- Batten, A. J. (2010). Clothing and Adornment. *Biblical Theology Bulletin: Journal of Bible and Culture*, 40(3), 148-159. <https://doi.org/10.1177/0146107910375547>
- Bolisay, R. (2017). Mapping of MoMA and the Current Philippine Cinema. *Plaridel*, 14(2), 207-212. <http://www.plarideljournal.org/wp-content/uploads/2018/04/2017-02-Bolisay.pdf>
- Braun, V., & Clarke, V. (2012). Thematic analysis. H. Cooper, P. M. Camic, D. L. Long, A. T. Panter, D. Rindskopf, & K. J. Sher (Eds.), *APA handbooks in psychology®. APA handbook of research methods in psychology*, 2, 57-71. <https://doi.org/10.1037/13620-004>
- Callenbach, E. (1966). Review: The Five C's of Cinematography: Motion Picture Filming Techniques Simplified by Joseph V. Mascelli. *Film Quarterly*, 19(4), 69-70. <https://doi.org/10.2307/1210422>
- Clark, C. (2008). Film families: The portrayal of the family in teen films from 1980 to 2007. *All Theses and Dissertations*, 1-99. *Scholars Archive*. <https://scholarsarchive.byu.edu/etd/1601>



- First, J. (2008). Making Soviet melodrama contemporary: Conveying 'emotional information' in the era of stagnation. *Studies in Russian and Soviet Cinema*, 2(1), 21-42. https://doi.org/10.1386/srsc.2.1.21_1
- Frost, W. (2009). From Backlot to Runaway Production: Exploring Location and Authenticity in Film-Induced Tourism. *Tourism Review International*, 13(2), 85-92. <https://doi.org/10.3727/154427209789604570>
- Håkansson, C. (2013). Re-examining the Traditional Principles of Cinematography of Modern Movies: a Case Study of Children of Men and Clerks II. <https://doi.org/10.33178/alpha.17.13>
- Heo, J., Chun, S., Kim, B., Ryu, J., & Lee, Y. (2017). Leisure activities, optimism, and personal growth among the young-old, old-old, and oldest-old. *Educational Gerontology*, 43(6), 289-299. <https://doi.org/10.1080/03601277.2017.1289457>
- IMDb. (2019). Lola Igna. <https://www.imdb.com/title/tt10965300/>
- Lim, M. K. (2019). The Making of Philippine Independent Cinema. *Philippine Cinema and the Cultural Economy of Distribution*, 39-66. https://doi.org/10.1007/978-3-030-03608-9_3
- Ortiz, S. (2020, July 30). *Binging During Quarantine: Pamilya Ordinaryo*. Film Development Council of the Philippines. <https://www.fdcph.ph/media/binging-during-quarantine-pamilya-ordinaryo>
- Park, Y., Lee, D., & Wagner, K. B. (2017). Changing Representations of the Urban Poor in Korean Independent Cinema: Minjung Heroes, Atomized Paupers, and New Possibilities. *Quarterly Review of Film and Video*, 34(4), 361-378. <http://dx.doi.org/10.1080/10509208.2016.1241627>
- Pathak, D. N. (2017). Melodramatic South Asia: In Quest of Local Cinemas in the Region. *Journal of Human Values*, 23(3), 167-177. <https://doi.org/10.1177/0971685816689742>
- Pramaggiore, M., & Wallis, T. (2005). *Film: A critical introduction*. Laurence King Publishing.
- Tatcho, O. B., & Barrias, A. S. (2016). Gay issues and themes in Philippine independent and mainstream films. In *Proceedings of the 2nd World Conference on Media and Mass Communication*, 1, 34-41. <http://tiikm.com/publication/doi/medcom.2016.1104.pdf>
- Transit (2013 film). (2020, April 12). In Wikipedia. [https://en.wikipedia.org/wiki/Transit_\(2013_film\)](https://en.wikipedia.org/wiki/Transit_(2013_film))
- Zurcher, J., Webb, S., & Robinson, T. (2018). The portrayal of families across generations in Disney animated films. *Social Sciences*, 7(3), 1-16. <http://dx.doi.org/10.3390/socsci7030047>



Perceptions of Parents' Attitudes towards Activism and its Impacts on the Political Behavior of Undergraduate Student Activists

Karl Aidan L. Nepomuceno, Cheyanne Aryani A. Niesta, Marie Joanna A. Paguirigan
and Rigel Ruel E. Portales

De La Salle University Senior High School - Manila Campus

Abstract: This paper seeks to study student activism by focusing on how parents' perception of their activism affects their political actions and decisions. Six students from three undergraduate student activist organizations across Metro Manila were purposely sampled to participate individually in a semi-structured interview developed around the concept of attitudes categorized into three components: the behavioral, the cognitive, and the affective. Thematic analysis reveals that parents generally tend to negatively perceive activism, which does not necessarily affect students' decision to continue activism despite accompanying emotional burdens. The findings ascertain that parents employ various parenting styles from rational to authoritarian and emotions such as worry and rage in reaction to their child's activism. Moreover, the participants were found to apply values such as tireless persuasion and discretion to negotiate conflicting perceptions of their activism with their parents.

Key Words: student activism; political socialization; political behavior; perception; parental attitudes

1. INTRODUCTION

1.1. Overview

In the 21st century, there has been substantial growth in the number of youth political activists; however, due to a heating political climate nowadays, adults – especially the parents of youth political activists – have second thoughts on this rapid uprising (Madarang, 2019; Pedrajas, 2021). It has been common knowledge that parents have a significant role in shaping and guiding their offspring's political views and involvement (Davies, 1965). The directness in youth political activism has paved the way for notable contributions to Philippine independence (“APPENDIX: A history,” n.d.; Palafox, 2012). In the present, numerous student protest organizations still exist in pursuit of nationalism by expressing their stand on social issues (“Akabayon Youth,” n.d.; “Anakbayan PH,” n.d.; Moreno, 2020; “SALiGAN sa CSSP,” n.d.). Several different factors influence political activism on the youth; however, participation in such activities may also be affected by how parents perceive their children's actions (Gordon, 2008). This paper seeks to study the phenomena of student protests from the context of the Filipino family with a focus directed at the perceptions of student protesters towards their parents' attitudes.

1.2. Participants

The researchers seek to answer their research questions by conducting a semi-structured interview

with purposive sampling targeting the population of undergraduate activist organizations in Manila. Four participants were from Anakbayan PLM, one from Akbayan Youth - UP Diliman, and one from SALiGAN sa CSSP, accounting for a sample of $n = 6$. Five participants had parents who were aware of their activism, while one had parents who were unaware.

1.3. Significance of the Study

This study will benefit the following people and institutions: student activists and their parents, schools, and future researchers. It will provide student activists' accounts of their parents' attitudes towards activism. Thus, it may help both parents and students understand each others' insights so both parties can communicate better. Schools may disseminate findings from this study regarding student activism to their student's parents and the student body. Moreover, future researchers may use this study as a reference as it contains new insights from student activists in prominent universities in the Philippines.

1.4. Research Questions

Socialization has piqued the youth's interest in political activism and even led to significant contributions to the country's independence. Davies (1965) postulated that this molding occurs in childhood mainly through their family --- and as the youth get older, they usually disassociate themselves from the mindsets of their family and engage more



with their peers. Montiel and Chongbian (1991) deduced that parents had influenced their children's political values during the Martial Law period. However clear it may seem, there are still gaps left in understanding the prominence of parents' attitudes to their children's political interests. The following research questions serve to clarify the gaps:

- R1: How do parents' attitudes towards activism affect political actions and behaviors?
- R1.1: How do parents of undergraduate student activists perceive "activism"?
- R1.2: How do these perceptions impact the decisions of undergraduate student activists?
- R1.3: How do undergraduate student activists negotiate conflicting perceptions with parents?

2. METHODOLOGY

Data was gathered in a semi-structured interview format, with each participant interviewed separately. The interview format makes for more in-depth discussions about personal and social issues that may be more difficult to discuss in a group setting (Di Cicco-Bloom & Crabtree, 2006). Thematic analysis was used to comprehend the experiential data by identifying common themes observed across most of the interviews (Braun et al., 2019). Two main processes were used under thematic analysis: coding and theme searching. Codes were developed through individual interpretations of the researchers, with one meeting to finalize the codes and assign them to their respective themes. The criteria for codes to be considered relevant are present in at least two out of the six interviews. The questions asked in the interview require the respondents to provide personal information about family issues. Therefore, the researchers provided an informed consent form to prevent any ethical breaches in data collection.

3. RESULTS AND DISCUSSION

Table 1. Synthesis Table for Codes and Themes

Perceptions of Parents Attitudes			Impacts on Political Behavior
Cognitive	Affective	Behavioral	
Acknowledgement of Red Tagging of NDMOs	Passive Acceptance of Children's Activism	Conditional Recognition of Children's Activism	Risks on Mental Health
Limited Understanding/ Experience of Activism	Developing Sense of Inquiry and Curiosity to Activism	Emotionally Detached Parenting Style	Tireless Persuasion Activism as Fulfillment of Parents' Teachings
Perception of Activism as "Brainwashing"	Fear for Children's Safety	Rational Parenting Style	Discretion and Lying to Parents
Activism as a Public Nuisance	Rage over Children's Decisions	Authoritarian Parenting Style and Emotional Blackmail	Family having little to no impact on Political Decisions

The researchers developed four themes based on thematic patterns seen among the codes of the six interviews: the cognitive, affective, and behavioral

components of the parents' attitudes (Fishbein & Ajzen, 1977) and their impacts on the political behavior of their children. The cognitive discusses the beliefs and perceptions of parents towards activism. The affective deals with their emotional reaction while the behavioral addresses their actions. The impacts on political behavior mainly deal with psychosocial effects and the political decision-making of the activists.

3.1. Cognitive Component

Almost all interviewees mentioned their parents' immediate negative perception of activism fueled by the prominence of red-tagging. First, they believe there is an underground movement that creates terrorists. Hence, they develop a weariness for their children to join rallies, as they consider it a slippery slope into the movement. These are similar to the beliefs of anti-communist, parent-based organizations, League of Parents in the Philippines (LPP), and Hands Off Our Children. Second, parents have a limited understanding and experience of activism, which leads them to reiterate popular stereotypes. Their children usually face resistance in political discussions due to their pro-administration, centrist, or apolitical leanings. Third, parents perceive activism as "brainwashing" rather than as a legitimate political choice. This perception leads to the belief that their child is in a danger they are not aware of, supported by Filipino parental ethnotheories that conceive the child as unable to develop self-control and reason yet (Alampay, 2014). Furthermore, similar to Di Cicco's (2010) public nuisance paradigm, parents perceive activism as a nuisance to the country, questioning why activists look for problems when there are none.

3.2. Affective Component

Participants who perceive that their parents' overall feelings concerning the participants' activism are generally positive indicate that their parents respond passively. Some parents expressed this in the following manner:

...basta raw 'di nakakaapekto sa acads ko and 'di ako nadidistract masyado. (trans. ...as long as it does not affect my academics and I don't get too distracted.)

Kebs lang naman sila. (trans. They're usually just fine with it). [Kebs is an affirmative slang term that refers to "whatever".]

Parents' feelings were also in the form of curiosity. Some participants indicated that as time progressed, parents became accepting towards their children's activism and eventually acquired a sense of inquiry regarding what specific activities their children participated in.



Regarding those who declared that their parents have a generally negative feeling towards their children's activism, some participants stated that their parents usually have a sense of fear or worry when faced with the prospect of their children being youth political activists. One of the parents quotes: "Baka barilin ka ng mga sundalo. (trans. Soldiers might shoot you.)"

Another emotion expressed is rage, which is usually in the form of confrontational questions, threats, and ad hominem. As one participant said, "Minsan nagkakaroon ng mga argument na may kasamang ad hominem. So hindi nagiging maganda yung effect ng differing political stance dito sa bahay. (trans. Sometimes there would be arguments with ad hominem. Thus, differing political stances in this house do not have a positive effect.)"

3.3 Behavioral Component

The respondents discussed their parents' behavior towards their activism positively and negatively based on the amount of freedom they were afforded. Parents generally allow their children to join activist organizations and related activities as long as they ensure their safety and maintain good academic performance.

The difference in parenting styles also affected the quality of freedom and support given. A respondent's parent who has a "rational parenting style" allows them to have independent political views and tries to listen and share their child's feedback and opinions, even if they have contrasting ideologies. On the other hand, emotionally detached parents do not get involved with their children's activities but still try to show affection in subtle ways, such as supporting their children financially and occasionally checking upon them. This is viewed as positive by the respondents because, ultimately, they still have the freedom to join mass organizations. An authoritarian parenting style is judged negatively by respondents as parents warn their children not to join activist organizations. They also mentioned that they got emotionally blackmailed by their family for being part of movements.

3.4 Impact on Political Behavior

Two interviewed participants described their behavior is motivated by their mental health. One participant's veteran grandfather called him to say, "You will be targeted and you will be killed." because of his activism. This led the participant to break down crying, and he adds that he would sometimes avoid political discussions with his parents because of the toll on his mental health. Another participant describes fears that "Papalayasin ako ng magulang ko." (trans. My parents would disown me.) after coming out to her parents as an activist, which is

consistent with Dela Cruz's (2001) and Jocano's (1970) research on "disiplina" and punishment

Participants with parents who are non-supportive about their activism and who hold control over their movement talk about how they have practiced being discreet about their activism. One participant frequently lied about going to her friend's house when attending organization meetings and activities, while another described slipping away from their home to join a rally. If they do not choose to be discreet and decide to tell the truth, some fear that they will not be allowed or that they would be grounded as a result. The use of discretion and lying replicates the findings of Gordon (2008) regarding the similar strategies of young female activists; however, this does not mean that they hold ill intentions towards their parents.

As another participant says, "Hindi tinuturo sa pagiging aktibista ang pagiging suwail na anak." (trans. Being an activist doesn't teach you to be a disrespectful child). He brings up how his organization has a specific educational discussion entitled "Parents and Activists" based on writings by Constantino (1971). He adds that he sees his activism as fulfilling his parents' teachings to him. One interviewee expresses her desire to become emotionally closer to her parents after coming out as an activist.

Most of the activists interviewed see tireless persuasion as their response to the conflict. They progressively explain their organization, activities, and political ideology while engaging in discussions about social issues with their parents. This is in line with Mcdevitt and Chafee's (2002) model of trickle-up socialization, where children can influence the political socialization of their parents. Part of the persuasion is also proving how the activists can maintain their grades, do their chores, as one participant puts it, "kahit member ako" (trans. even if I'm a member) which is in line with Medina's (2001) conceptualization of the numerous practical responsibilities of the child to the family based on "utang na loob."

Despite family influencing political behavior, most participants believe that family opinion has little to no impact on their decision to continue activism. This is because those interviewed either live separately from their parents, have parents with rational or detached parenting styles, or are discreet about their activism. These reasons are either strategies that address the authoritarian influence of Filipino parents (Dela Cruz et al. 2001; Jocano, 1970; Sicat, 1976), or circumstances that avoid it altogether.

4. CONCLUSIONS

An overview of the results and discussions shows the conflicting nature of parents' attitudes towards activism. Their cognitive perceptions are



susceptible to being informed by black propaganda and red-tagging activists as terrorists due to their limited understanding of activism. This is likely due to their Filipino socio-cultural environment, which informs their psychological processes and attitudes (Torney-Purta, 2004). This is supported by the general prominence of red-tagging in the Philippines by parent-based organizations and state efforts, and parental cultural beliefs.

As a consequence of their cognitive perceptions, parents behave and emote accordingly with the strictness or looseness of their parenting style, while their emotions towards activism constitute a range of passive acceptance, fear, or rage. Although the interviewed activists feel that their parents' attitudes burden their mental health in the form of anxiety and increased emotional burden, these attitudes have little impact on their overall decision to continue as active members of their organization.

In navigating the conflicting perceptions of their parents, most of the participants applied a strategy of discretion and tireless persuasion to pursue activism despite their parents' opposition and to challenge the political beliefs of their parents contrary to traditional Filipino family beliefs and power structures (Alampay, 2014; Montiel and Chongbuan, 1991). In their tireless persuasion, they see their parents as part of the masses rather than adversaries, and they understand activism as an extension of their parents' teachings. The researchers conclude that even as the conflict may further separate activists from their parents, the intentions of activists are rooted in mending this conflict rather than exacerbating it with their love and respect of their parents underlying their actions.

4.1. Recommendations

Based on the findings, there were several recommendations that researchers can consider for future studies and application.

Since all participants were situated in Metro Manila only, it is suggested that researchers widen the scope to undergraduate student activists in different universities across the Philippines to understand the national situation regarding student political activism and parents' perception of such.

This study merely focused on identifying the phenomena of student activism and political attitudes through parents' perceptions. Thus, the researchers call future researchers to consider several other social relationships that influence the behavior of student activists concerning their activism.

Lastly, the researchers submit that succeeding research should focus on whether parents' perceptions significantly affect Filipino student activists' tendency to participate in the different levels of activism, which may include dutiful, disruptive, and

dangerous dissent, as stated by O'Brien et al. (2018).

5. ACKNOWLEDGMENTS

The researchers would like to thank their Research adviser, Ms. Topin Ruiz, and Practical Research 1 and 2 teachers, Dr. Madelene Sta. Maria and Dr. Thelma Mingo, who guided, helped, and supported them in carrying out the research. Without their assistance and dedicated involvement in every step throughout the process, this paper would have never been accomplished.

The researchers would also like to express their deep and sincere gratitude to their families, who showed and gave their unending support in all their tasks. This research paper stands as a testament to their unconditional love and encouragement.

In addition, the researchers would like to extend their appreciation to the Senior High School Department of De La Salle University, Manila, specifically to their classmates from HUMSS 11-D and HUMSS 12-A, for cheering them up and giving out moral support to make sure that the research would see the light of the day.

Furthermore, the researchers would want to convey their thanks to the executive board and members of Anakbayan PLM, Akbayan Youth - UP Diliman, and SALiGAN sa CSSP, for generously granting the researchers permission to scrutinize and study their personal lives in service of humanizing the individual nuances of their collective struggle against social inequalities.

Lastly, the One who made it all possible, The Almighty God, for giving them confidence, courage, perseverance, and knowledge to be an instrument for others' transformation and for His shower of blessings throughout the process of completing their research successfully.

6. REFERENCES

- About SALiGAN sa CSSP. (n.d.). <https://saligansacssp.weebly.com/about-saligan-sa-cssp.html>
- Akbayan Youth (n.d.). About us. [Blog Post]. <https://akbayanyouth.wordpress.com/about-akbayan-youth/>
- Anakbayan PH. [@anakbayanphils]. (n.d.). Long description. [Facebook Bio]. <https://www.facebook.com/anakbayanphils/about>
- APPENDIX: A history of the Philippine Political protest: Govph. (n.d.). Official Gazette. <https://www.officialgazette.gov.ph/edsa/the-ph-protest-appendix/>
- Braun, V., Clarke, V., Hayfield, N., & Terry, G. (2019). Thematic analysis. *Handbook of research methods in health social sciences*, 843-860.
- Constantino, R. (1971). *Parents and Activists*. Malaya Books.



- Davies, J. C. (1965). The family's role in political socialization. *The Annals of the American Academy of Political and Social Science*, 361(1), 10-19.
- Di Cicco, D. (2010). The public nuisance paradigm: Changes in mass media coverage of political protest since the 1960s. *Journalism & Mass Communication Quarterly*, 87(1), 135-153. <https://doi.org/10.1177/107769901008700108>
- DiCicco-Bloom, B., & Crabtree, B. F. (2006). The qualitative research interview. *Medical education*, 40(4), 314-321.
- Fishbein, M., & Ajzen, I. (1977). *Belief, attitude, intention, and behavior: An introduction to theory and research*. Addison-Wesley Publishing Company.
- Gordon, H. R. (2008). Gendered paths to teenage political participation: Parental power, civic mobility, and youth activism. *Gender & Society*, 22(1), 31-55.
- Jocano, F. L. (1970). Maternal and child care among the Tagalogs in Bay, Laguna, Philippines. *Asian Studies*, 8(3), 277-300.
- Madarang, C. S. (2019, September 06). These parents say left-leaning groups kidnapped their kids. here's the rub. *Interaksyon PH*. <https://interaksyon.philstar.com/rumor-cop/2019/09/06/154269/league-parents-missing-children-communist-npa-rebels/>
- McDevitt, M., & Chaffee, S. (2002). From top-down to trickle-up influence: Revisiting assumptions about the family in political socialization. *Political Communication*, 19(3), 281-301
- Medina, B. (2001). *The Filipino family* (2nd ed.). University of the Philippines Press.
- Montiel, C. J., & Chiongbian, V. M. (1991). Political psychology in the Philippines. *Political Psychology*, 759-777.
- O'brien, K., Selboe, E., & Hayward, B. M. (2018). Exploring youth activism on climate change. *Ecology and Society*, 23(3).
- Palafox, Q. A. J. (2012). The role of student activism in the Philippine independence. <http://nhcp.gov.ph/the-role-of-student-activism-in-the-philippine-independence/>
- Pedrajas, J. (2021, January 26). UP community members, anti-communist parents clash over protest. *Manila Bulletin*. <https://mb.com.ph/2021/01/26/up-community-members-anti-communist-parents-clash-over-protest/>
- Sicat, L. M. (1976). Political socialization in the Philippines today: An empirical study. *Philippine Political Science Journal*, 3(1), 135-139. <https://doi.org/10.1163/2165025X-00301014>
- Torney-Purta, J. (2004). Adolescents' political socialization in changing contexts: An international study in the spirit of Nevitt Sanford. *Political psychology*, 25(3), 465-478. *Philippine Political Science Journal*, 3(1), 112-134.



Nationalism and Social Advocacy Amongst Select Generation Z University Students in Metro Manila

Hannah Sophia V. Edralin and Czerina Helene R. Garcia
Assumption College San Lorenzo, Makati City

Abstract: Nationalism and Social Advocacy are two aspects that build the youth's collective social and political identity. This study focused on identifying the significant relationship between nationalism and social advocacy amongst 35 select Generation Z university students. With the use of the ISSP National Identity Module 2013 Edition and the Social Issues advocacy scale, the respondents' nationalism and social advocacy levels were defined, respectively. Along with a letter of informed consent, both scales were embedded and distributed using an online survey tool to individuals that fit the inclusion criteria within Metro Manila. The results were analyzed and organized using the Pearson R Correlation test and descriptive statistics per variable, under the SPSS Statistics tool ver. 27, to determine the possible relationship between these two variables. The findings show that select university students have a high level of nationalism and social advocacy, and a strong positive significant relationship was found between the two variables. In addition to this, the direct relationship between both variables may indicate increased civic engagement, hence the recommendation of studying either variable in political activism amongst the youth or another field of university students in Metro Manila.

Key Words: nationalism; social advocacy; national identity; engagement; activism

1. INTRODUCTION

It is essential to realize that the study of nationalism is more than just a citizen's love for their country. Bonikowski (2016) perceives nationalism as part of daily human behavior rather than a political ideology. The internal sense of nationalism may be related to an individual's sense of advocacy or external action. The research study of McInroy and Beer (2020) emphasizes that social advocacy is of great concern to the youth and could be related to their overall national awareness or feelings towards the country.

Although it is acknowledged that there have been studies in the past which tackled Nationalism and Social Advocacy, there remains to be a limited number of previous research studies that focus on the possible relationship between them amongst Philippine Generation Z University students. This idea considers the development of their maturity amidst different social movements (Schwieger & Ladwig, 2018). A study by Fietzer and Ponterotto (2015) acknowledges a particular need to measure an individual's level of social advocacy given the prevalence of social issues. This need also considers the different factors that may affect it, including nationalism, which emphasizes studying the relationship between these two variables.

This research study aims to determine if there is a significant relationship between

nationalism and the level of social advocacy of select university students in Metro Manila. It acknowledges that there is an urgency for the said discussion. Each variable may be the root of social participation from the youth, which is essential in different social issues in the Philippines. The findings of this research shall contribute to the overall understanding and knowledge of nationalism and social advocacy, should a relationship exist between them.

2. REVIEW OF RELATED LITERATURE

2.1 Nationalism in the Philippines

In a socio-cultural approach of nationalism, it impacts particular exclusionary and individual conducts, which is then regarded as a relevant social identity (Latcheva, 2010). A study by Seton-Watson (2019) examines nationalism in political movements that aim to achieve the "national purpose" and how state policies and relationships influence it. Takagi (2016) defines Philippine nationalism as a factor contributing to breaking free from colonialism, especially under the idea that concept studies lean more towards the state's active role in politics, as one's nation depends on nationalism as a basis for policy-making. Additionally, Reid (2010) states that the Philippines is the model for anti-imperialist



nationalism, observed through the country's long history of rebelling against its colonizers, especially Spain.

2.2 Social Advocacy in the Philippines

A research study by Barnhardt, Sheets, and Pasquesi (2015) found that those who showed personal advocacies, including nationalism, contributed to building the respondent's social identity. The Social Issues Advocacy scale further supports this view or definition of social advocacy, given the establishment of advocacy to civic engagement (Nilsson, et al., 2011). In the Philippine context, Ty (2011) states that social advocacy may be used as a framework for society in fighting against social injustices in the Philippines. This study shows that the discussion of this concept in the Philippine context is more inclined towards its general social implications rather than its relationship with other fundamental concepts.

2.3 Nationalism and Social Advocacy

Research analysis by Pyrhonen (2015) partly looked into the relationship between these variables only in the context of right-wing advocacies. While this study was able to involve the variable of Nationalism through a literature review, it did not discuss the manifestations of such in its respondents and establish a quantifiable relationship with social advocacy. Similarly, a research study by Ahmad, Alvi, and Ittefaq (2019) suggests that an individual's feelings towards a country and its citizens may be associated with their level of civic engagement or social advocacy.

2.4 Synthesis

Nationalism and social advocacy have influenced both individual and collective behavior amongst people. In this research, it is understood that nationalism is an aspect of an identity that influences human behavior. On the other hand, social advocacy refers to the pursuit of social justice in civic engagement. Civic engagement is encouraged by a sense of social advocacies, including nationalism, as it helps build one's foundation of social identity. Several studies have used the two concepts in different contexts and perspectives to relate nationalism and social advocacy. However, there are rarely any studies grounded on quantifying nationalism and social advocacy in the Philippine context. Overall, these literature and studies have proven that nationalism and social advocacy play vital roles in the attitudes and perspectives across society, thus being significant towards achieving the research objectives.

3. CONCEPTUAL FRAMEWORK

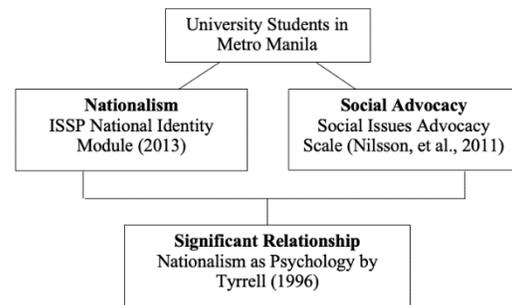

Figure 1. Research Paradigm

The figure presented above represents the research paradigm and conceptual framework of the study. To achieve the study's goal, the researchers plan to measure the variables Nationalism and Social Advocacy using selected research instruments, namely the National Identity Module and the Social Issues Advocacy Scale, respectively. The data shall be gathered from the respondents to suggest an existing significant relationship between the variables, presumably a direct one, and examine such.

4. STATEMENT OF THE PROBLEM

The purpose of this study is to determine and discuss if there is a significant relationship between the level of nationalism and social advocacy of the respondents. Hence, the following research questions.

What is the students' level of nationalism given the sum of their survey results under the defined research instrument?

What is the students' level of social advocacy given the sum of their survey results under the defined research instrument?

Is there a significant relationship between the level of nationalism and social advocacy of the respondents?

5. METHODOLOGY

5.1 Research Design

The research design utilized in this study would be correlational. According to Rodriguez-Bailon, et al. (2017), correlational studies are best used in describing socio-cultural aspects as it leads to a deeper understanding of systematic and social complexity.

With this, the researchers believed that this design was most appropriate for the paper, considering the main objective of this study.



5.2. Sample and Sampling

his research study contained thirty-five respondents from different universities across Metro Manila of ranging socioeconomic status. It was a requirement for these respondents to have been a student of a Humanities and Social Sciences related course for at least two years. According to a book by Nussbaum (2010), those with a background in the humanities are more inclined to think critically when faced with nationalistic and social issues. Additionally, it was also a requirement for these respondents to have been citizens of the Philippines for at least five years. This criterion has been chosen based on the analysis of Barrett and Flood (2020). They state that citizenship plays a big role in nationalism due to increased cultural inclusivity and social awareness.

The respondents for this research were selected with the use of a non-probability sampling technique, purposive sampling. According to Black (2010), this sampling technique entails the researchers selecting their respondents given a particular set of criteria. This proved to be most appropriate for this research. The inclusion criteria were verified with two confirmatory questions regarding their course and residency, given the large population of university students in Metro Manila.

5.3. Research Instrument

To measure the independent variable or the level of nationalism of the selected respondents, the researchers utilized the publicly available National Identity Module as published by the International Social Survey Programme, 2013 edition. The questionnaire contained twenty-one Likert scale questions that measure one's national identity, ranging from 1 or Strongly Disagree, to 5 or Strongly Agree, given the following statements. An example includes the question, "how proud are you of being Filipino?" For this research, the researchers only selected five of these questions, which were primarily related to nationalism, under the consultation of social science professionals and the advice of the creators of the questionnaire.

As for the dependent variable or the level of social advocacy of the selected respondents, the researchers utilized the Social Issues Advocacy Scale (SIAS) 2011, a twenty-one-item Likert-type scale that measures an individual's social justice advocacy under four subscales. Similar to the previous ranking, the scale ranged from 1 or Strongly Disagree, to 5 or Strongly Agree, given the following statements. An example includes "how often do you participate in your local elections?" It was created by Nilsson, Marszalek, Linnemeyer, Bahner, and Misialek, with validity tested through its empirical comparison to a similar scale (Nilsson,

et al., 2011). The researchers found that the scale was able to measure different aspects of social advocacy reliably.

5.4. Data Gathering Procedures

An online survey questionnaire to measure each variable was created for the data-gathering portion. The questions were taken from the identified research instruments, including two questions to define the respondents' demographic profile and an embedded informed consent letter. The survey was distributed within Metro Manila with the use of communication platforms, thus collecting thirty-five respondents.

The researchers ensured their respondents' utmost confidentiality and privacy by asking only the necessary information needed for the research. Rest assured that the gathered data from this study was not and shall not be used for purposes other than this research study.

5.5. Data Analysis

Upon gathering the data for the study and organizing these in an excel spreadsheet, the researchers used descriptive statistics to determine the level of each variable. They used the Pearson Correlation Coefficient, as created by Karl Pearson (1896), as the statistical treatment, seeing that all assumptions were met in the results. This was the most appropriate statistical treatment in testing the hypothesis to determine if there is a significant relationship between two variables amongst the respondents, given a specific range (Magnello, 2014).

6. Results

In analyzing the gathered data, Pearson's r-Correlation was utilized to determine the relationship between the respondents' level of nationalism and social advocacy.

Table 1
 Demographic Profile: Respondents' Courses and Year level

Course	Frequency	Percentage
AB/BA Communication	2	5.71
AB/BA Creative Writing	1	2.86
AB/BA Early Childhood Education	1	2.86
AB/BA Development Studies	3	8.57
AB/BA Diplomacy & International Relations	8	22.86
AB/BA History	3	8.57
AB/BA Information Design	1	2.86
AB/BA Interdisciplinary Studies	1	2.86
AB/BA International Studies	2	5.71
AB/BA Journalism	1	2.86
AB/BA Philosophy	1	2.86
AB/BA Political Science	5	14.28
AB/BA Psychology	5	14.28
AB/BA Sociology	1	2.86
Total	35	100

Table 1 Demographic Profile: Respondents' Course and Year Level



Table 1 shows that the respondents came from various Humanities and Social Sciences (HUMSS) college courses, all of which are above the first-year level and qualify for the inclusion criteria. The most common course amongst the respondents was AB/BA Diplomacy & International Relations, with eight respondents (22.86%) coming from varying year levels.

Table 2
 Demographic Profile: Respondents' Year Level in University

Year Level	Frequency	Percentage
2nd Year	23	65.71
3rd Year	8	22.86
4th Year	4	11.43
Total	35	100

Table 2 Demographic Profile: Respondents' Year Level in University

Table 2 presents the variety of university year levels among the respondents. As shown, the majority of the respondents are 2nd Year university students, with 23 (65.57%) of them being under this category.

Table 3
 Demographic Profile: Respondents' Years of Philippine Citizenship

Years of Citizenship	Frequency	Percentage
18 years	6	17.14
19 years	12	34.29
20 years	9	25.71
21 years	7	20.00
22 years	0	0.00
23 years	1	2.86
Total	35	100

Table 3 Demographic Profile: Respondents' Year of Philippine Citizenship

All respondents have been citizens of the Philippines for more than five years or the inclusion criteria. The shortest time of citizenship years would be 18 years, with six respondents (17.14%).

Table 4
 Descriptive Statistics on Respondents' Level of Nationalism

Properties under Nationalism	Mean	SD
Importance of Philippine Laws	4.51	0.70
General View on the Philippines and its citizens	17.66	3.40
National Pride	12.17	2.65
Strong Patriotic Feelings in the Philippines	10.60	2.46

Note. The data was acquired from the respondents in the middle of the first semester.

Table 4 Descriptive Statistics on Respondents' Level of Nationalism

The data from Table 4 suggests that most of the respondents' feelings of nationalism come from their General View of the Philippines and its citizens (M=17.66, SD=3.40). This result indicates that nationalism may contribute to their overall national identity and perspective.

Table 5
 Descriptive Statistics on Respondents' Level of Social Advocacy

Properties under Social Advocacy	Mean	SD
Political and Social Advocacy	22.43	6.43
Political Awareness	22.46	5.84
Social Issue Awareness	18.09	3.53
Confronting Discrimination	13.49	2.91

Note. The data was acquired from the respondents in the middle of the first semester.

Table 5 Descriptive Statistics on Respondents' Level of Advocacy

The data from Table 5 suggests that one of the strongest factors contributing to the respondents' social advocacy would be Political Awareness (M=22.46, SD=5.84). Considering the definition of social advocacy in the research instrument, the results may imply that high levels of social advocacy may relate to one's awareness and support of social justice.



Table 6

Correlation of the Respondents' Level of Nationalism and Level of Social Advocacy

	Total Nationalism	Total Social Advocacy
Total Nationalism	1	.615*
Total Social Advocacy	.615*	1

* Correlation is significant at the 0.01 level (2-tailed)

Table 6 Correlation of the Respondents' Level of Nationalism and Level of Social Advocacy

Table 6 presents the association between the research variables. As shown, the variables are strongly correlated with each other $r(35)=.615$, $p<.01$. With this, the data suggests that there is a significant strong positive correlation, $r=.615$, $p=0.01$. This result supports the idea that one's personal and political ideologies may indicate a strong relationship with social advocacy and participation.

7. DISCUSSIONS

7.1 Summary and Conclusions

The results show a high level of respondent nationalism, especially when it came to their general view of the Philippines and its citizens, based on their feeling of national pride. It also shows a high level of respondent social advocacy revolving around their awareness of national political matters. The researchers have then discovered that the two variables are directly correlated to each other. High levels of nationalism amongst the respondents also corresponded to high levels of social advocacy.

In the presence of previous correlational studies conducted regarding the relationship of nationalism with other social ideologies, it is surprising that this study may become another indicator that nationalism has a relevant impact on human behavior, especially regarding national purpose (Seton-Watson, 2019). In line with this, the results suggest that nationalism may be an essential factor in the conduct of Generation Z.

Similarly, high levels of social advocacy amongst the respondents may relate to building one's social identity, as Barnhardt, Sheets, and Pasquesi (2015) explained. This idea may support how the respondents exhibited social advocacy through awareness of political issues as university students. The results suggest that because levels of social advocacy are high, the respondents may be actively engaged in civic movements relating to social justice.

The suggested significant relationship between the levels of nationalism and levels of social advocacy amongst the respondents can be supported by a research study by Ahmad, Alvi, & Ittefaq (2019). The study suggests that an individual's

feelings towards a country and its citizens may be associated with their civic engagement or social advocacy level.

The data analysis and results of the statistical test show similar results from the scales for nationalism and social advocacy, respectively. Hence, the researchers have rejected the null hypothesis and accepted the alternative hypothesis, indicating a significant relationship between the respondents' level of nationalism and social advocacy.

Considering that there may be a significant relationship between the variables and the respondents have expressed high levels for both, this may indicate that Generation Z university students in Metro Manila are nationalistic beings that are civically engaged in social advocacies.

7.2 Limitations and Recommendations

A notable limitation of this research would be the chosen sample given the inclusion criteria. This research was limited to only those taking up a Humanities and Social Sciences (HUMSS) related course for university, resulting in a total of only 35 respondents. The researchers acknowledge the lack of generalizability given this criterion and the two-month duration of the research; however, the researchers believe that it remains valid due to related research for the necessary assumptions taken and the results presented.

For those who wish to pursue this topic and extend the research regarding this, the researchers would recommend exploring these variables, including an increased range of college courses. This recommendation may broaden the scope of the research as well as the sample size. In addition to this, the researchers would recommend exploring the relationship of either variable with political activism, considering the observed similarity among the survey questions.

8. ACKNOWLEDGMENTS

This research paper's creation process was a journey towards further understanding nationalism and social advocacy amongst Generation Z university students. The researchers wish to extend their utmost gratitude towards everyone who has made this study possible.

Firstly, to their teacher for Research in Daily Life 2: Quantitative Research, Ms. Mirasol S. Madrid, for her continuously effective instruction and guidance throughout the research. Secondly, to Professor Johanna E. Nilsson and Professor Jacob M. Marszalek, for permitting the researchers to utilize their Social Issues Advocacy Scale (SIAS-2) to determine the level of social advocacy amongst the selected respondents. Thirdly, to each individual



who consented to participate in the research, generously sharing their time and effort in answering the given items.

Last but not least, to Assumption College, San Lorenzo, for the institution's constant support in this academic endeavor. The researchers would not have achieved such knowledge without the support of everyone. Thank you, all!

All for Jesus, in Jesus. Embrace new life, be a gift to others!

9. REFERENCES

- Ahmad, T., Alvi, A., & Ittefaq, M. (2019). The Use of Social Media on Political Participation Among University Students: An Analysis of Survey Results From Rural Pakistan. *SAGE Open*, 9(3), 215824401986448. <https://doi.org/10.1177/2158244019864484>
- Barnhardt, C. L., Sheets, J. E., & Pasquesi, K. (2015). You Expect What? Students' Perceptions as Resources in Acquiring Commitments and Capacities for Civic Engagement. *Research in Higher Education*, 56(6), 622–644. <https://doi.org/10.1007/s11162-014-9361-8>
- Barrett, M., & Flood, C. (2020). *Nationalism, ethnicity, citizenship: Multidisciplinary perspectives*. Cambridge Scholars Publishing.
- Black, K. (2010). *Business statistics: contemporary decision making*. Ontario: John Wiley & Sons Canada, Ltd.
- Bonikowski, B. (2016). Nationalism in Settled Times. *Annual Review of Sociology*, 42(1), 427–449. <https://doi.org/10.1146/annurev-soc-081715-074412>
- Curtis, E. A., Comiskey, C., & Dempsey, O. (2016). Importance and use of correlational research. *Nurse researcher*, 23(6).
- Fietzer, A. W., & Ponterotto, J. (2015). A Psychometric Review of Instruments for Social Justice and Advocacy Attitudes. *Journal for Social Action in Counseling & Psychology*, 7(1), 19–40. <https://doi.org/10.33043/jsacp.7.1.19-40>
- Latcheva, R. (2010). Nationalism versus Patriotism, or the Floating Border? National Identification and Ethnic Exclusion in Post-communist Bulgaria. *Journal of Comparative Research in Anthropology and Sociology*, 1(2):187-216.
- Magnello, M. E. (2014). *Pearson, Karl: His Life and Contribution to Statistics*. Wiley StatsRef: Statistics Reference Online. <https://doi.org/10.1002/9781118445112.stat04822>
- McInroy, L. B., & Beer, O. W. (2020). Wands up! Internet-mediated social advocacy organizations and youth-oriented connective action. *New Media & Society*, 146144482096480. <https://doi.org/10.1177/1461444820964809>
- Nilsson, J. E., Marszalek, J. M., Linnemeyer, R. M., Bahner, A. D., & Misialek, L. H. (2011). Development and Assessment of the Social Issues Advocacy Scale. *Educational and Psychological Measurement*, 71(1), 258–275. <https://doi.org/10.1177/0013164410391581>
- Nussbaum, M. (2010). *Not for Profit: Why Democracy Needs the Humanities*. PRINCETON; OXFORD: Princeton University Press. <https://doi.org/10.2307/j.ctt7rpcw>
- Pyrhönen, N. (2015). *The True Colors of Finnish Welfare Nationalism*. Helsinki. <http://urn.fi/URN:ISBN:978-952-10-8837-7>
- Reid, A. (2010). *Imperial alchemy: Nationalism and political identity in Southeast Asia*. Cambridge University Press.
- Rodriguez-Bailon, R., Bratanova, B., Willis, G. B., Lopez-Rodriguez, L., Sturrock, A., & Loughnan, S. (2017). Social Class and Ideologies of Inequality: How They Uphold Unequal Societies. *Journal of Social Issues*, 73(1), 99–116. <https://doi.org/10.1111/josi.12206>
- Schwieger, D., & Ladwig, C. (2018). Reaching and Retaining the Next Generation: Adapting to the Expectations of Gen Z in the Classroom. *Information Systems Education Journal*, 16(3), 45–54. <http://search.ebscohost.com.ezproxy.upd.edu.ph/login.aspx?direct=true&db=eric&AN=EJ1179303&site=ehost-live>
- Seton-Watson, H. (2019). *Nations and States: an enquiry into the origins of nations and the politics of nationalism*. Routledge.
- Takagi, Y. (2016). *Central Banking as State Building: Policymakers and Their Nationalism in the Philippines, 1933-1964 (Vol. 17)*. Nus Press.
- Ty, R. (2011). Social injustice, human rights-based education and citizens' direct action to promote social transformation in the Philippines. *Education, Citizenship and Social Justice*, 6(3), 205–221. <https://doi.org/10.1177/1746197911417413>



A Comparative Study on the Effects of Size and Sources or Traceability on the Price of Identified Fish Species Sold at Muñoz Market, Quezon City

Jianna S. Gapuz, Mikhail Aleksandr B. Ruelos, Derek Colbee B. Uy
and Mikhael Rafael Miguel C. Yao
De La Salle University Integrated School, Manila

Abstract: The diversity of fish in markets is constantly dynamic under several factors. The study aims to find the correlation of these factors and their effects with the selection of fishes found in Muñoz Market. This study adopted the research design of the two previous studies to ensure consistency in assessing the gathered data. The researchers utilized premade questionnaires that were given to the vendors working inside Muñoz Market. In analyzing the data, the researchers applied Pearson's correlation coefficient to assess the factors' correlation between them. The results showed an increase in the number of identified species and the price and size range of the fish placed in the market. This implies that the domain of the market is constantly increasing. The market is more diverse than in the past, where new species are introduced to the market and made accessible to the general public at Muñoz Market.

Key Words: fish diversity; aquaculture; marine biodiversity; Muñoz Market; Philippines

1. INTRODUCTION

Fish are a significant component in consuming a regular Filipino's diet, being highly associated with a reduced risk of coronary diseases due to their high protein and omega-3 fatty acid content (Soluta, 2021). Because of the versatility of fish, namely its accessibility, nutrition value, and affordability, Filipinos all around the islands include fish in their list of provisions and daily diet. Fish do not only play a vital role in the consumption of Filipinos and hold a significant contribution to the country's livelihood in terms of being an occupation (BFAR, 2020). The marketplace is an environment where these two elements collide. A majority of fish that Filipinos allocate for consumption are bought in markets or wet markets. In light of this, one would speculate the factors that affect the diversity of fish that make it into the actual market.

This paper is a third-iteration study concerning the diversity of fish, specifically in Muñoz Market, Quezon City. The first being a study by Arcangel, Caleja, Ignao, and Orejudos in 2019, the second being a study by Valenzuela, Veluz, Villanueva, and Villarama in 2020, and this study in 2021. Both studies being equally comprehensive, distinct, and well-advised, the conclusions and analyses of both papers provided well-rounded and intricate insights on said topic. However, the observations collected by both papers are not constant.

The state in which the fish markets and wet markets are constantly changing due to external

factors such as climate, the economic state, the financial state of the consumers, the location, the season, and several others (Santos, Barut, & Bayate, 2017). There are natural, uncontrollable factors that contribute to the changing markets. However, some factors can be managed, such as the administration of the fishermen here in the Philippines. Given that fishers play a significant role in the economy, the issue concerning the security of the fishermen with the government is at large. Fishers are not given the due amount of care or protection when it comes to their welfare. Studying the trends and parameters inside the markets allows the monitoring of the effects of said disputes. It can inform the authorities about what is critical to protect the Filipinos' rights and the economy and help improve its state as of now.

This study aims to not only determine what factors cause direct or indirect changes to the variety of fish available in the Muñoz wet market but also analyze the trends and parameters of the fish within Muñoz Market with the past two studies by deriving patterns and trends in the fish's attributes and traceability.

The specific objectives of the study are as follows:

- a.) Determine what factors cause direct or indirect changes to the diversity of fish available in the Muñoz wet market.
- b.) Examine the parameters of the fish within Muñoz Market in comparison to the past two

studies by deriving patterns and trends in the fish's qualities and traceability.

2. METHODOLOGY

The primary source of data for this study were the stakeholders and fish vendors of Muñoz Market, located in Muñoz, Quezon City. An overview and a street perspective of Muñoz Market can be found in Figures 1 and 2, respectively.



Figure 1. Overview of Muñoz Market



Figure 2. Street view of Muñoz Market

2.1. Research Design

This research followed a quantitative design to gather numerical data from the aquaculture, specifically fishes, observed in Muñoz Market. The data was collected through a series of surveys where the respondents were required to fill in the size (mm), price (pHp/Kg), and source (location) of the fish. The data collection of this study was conducted from December 2020 - February 2021, or 13 weeks.

Shown in Figure 3 are the factors considered in obtaining the results for the correlation and comparison study of the fish diversity in Muñoz Market.

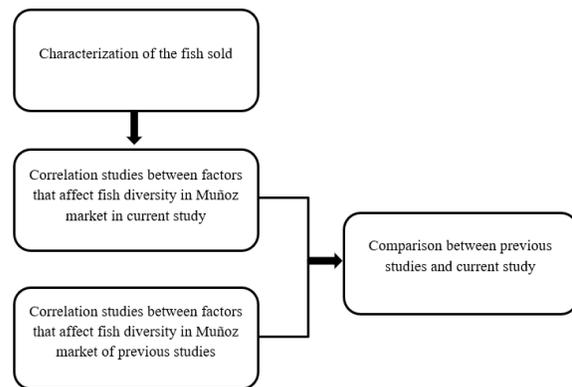

Figure 3. Theoretical Framework

2.2. Data Analysis

The results were tabulated utilizing Microsoft Excel, organized according to the code given in the survey form, which includes the length, price, and the source.

2.2.1. Analysis of Present Results

The initial observations from the data collected were summarized to provide an overview of the fishes included in the correlational studies.

2.2.2. Comparison of the Present Results with the Previous Studies

This study compared its findings with the two previous studies to see any consistent trends or notable differences.

2.2.3 Correlation Study

The researchers performed a correlational study between the size and source and its effects on the price of the fish to assess their relationship with each other individually. The correlation between the factors above was evaluated using Pearson's correlation coefficient (Equation 1). This was used in this study to ensure consistency in assessing parameters in line with the two previous studies.

$$r = \frac{n(\sum xy) - (\sum x)(\sum y)}{\sqrt{[n\sum x^2 - (\sum x)^2][n\sum y^2 - (\sum y)^2]}}$$

Where n is the number of paired values, $\sum xy$ is the sum of the products of paired values, $\sum x$ is the sum per family, $\sum y$ is the sum per family, $\sum x^2$ is the sum of squared x values, $\sum y^2$ is the sum of squared y values.

The parameters that were correlated include (a) the average price and source per family, (b) the average price and source per species, (c) the average

size and average price per family, and (d) the average size and average price per species.

3. RESULTS AND DISCUSSION

Discussed in this section are the obtained results and observations from the 13-week data collection period. This segment includes the comparison with previous results, the analysis of the current developments, and the correlational studies between the factors.

3.1. Analysis of Present Results

This section discusses the present results regarding the species, their respective sizes, prices, and sources. There were 74 individual species identified which were classified into 29 different families. The prices ranged from Php 90- Php 1200. The length of the observed fishes ranges from 40-890mm, and their average lengths per family are shown in Figure 4. The family Belontiidae showed to have the highest value length among all families, averaging at 880.87mm.

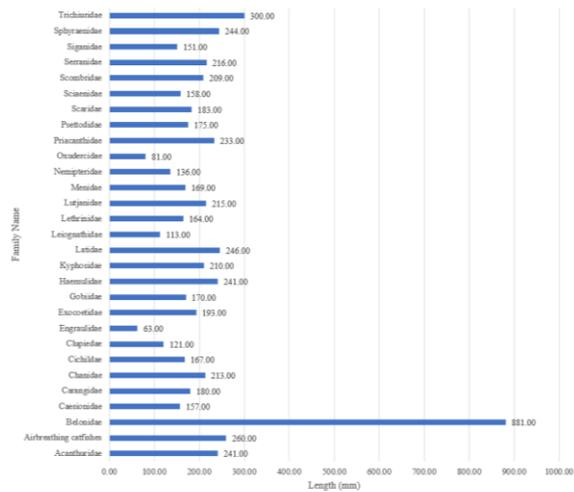

Figure 4. Average Length of Fishes per Family

There were seven sources of fishes identified, namely Lucena, Quezon, Farmers Quezon City, Malabon, Navotas, Batangas, and Dagupan. The primary source in this study is Lucena, totaling to 39% of the observed fishes. A visual representation of the sources can be found in Figure 5.

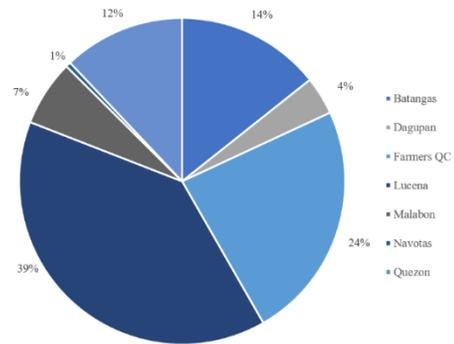

Figure 5. Sources of Fishes

3.2. Comparison of the Present Results with the Previous Studies

Presented in Table 1 is the summary of results in comparison with the two past iterations of this study.

Parameters	Arcangel, Caleha, Ignao, & Orejudos (2019)	Valenzuela, Veluz, Villanueva & Villarama (2020)	Current Study
No. of identified Species	59	66	74
Price range (Php/kg)	90-443.32	80-500	90-1200
Size range (mm)	63-565	25-563	40-890
No. of sources	7	8	7
Period of the Study	Nov 2018- Feb 2019	Sept 2019 - Jan 2020	Dec 2020 - Feb 2021

Table 1. Comparison of results between this study and previous iterations

There was an observed increase in the number of species identified, which were classified into 29 families. There was an increase in both the number of identified species and the price range and size range of the fish placed in the market. This implies that the domain of the market is constantly expanding, where the diversity of species found in the market is becoming more and more accessible to the general public.

A possible reason behind this is the effects of the nationwide quarantine for COVID-19. Since the entire population, fishers included were prohibited from carrying on their usual fishing activities in places like Malabon, Lucena, and Batangas. The



aquatic habitats were able to replenish themselves in terms of population. The prohibition in accessing these former fishing spots may also have contributed to the environmental rehabilitation of said habitats (Ocean Conservation Trust, 2020); thus, the fish could grow stronger, as observed in their increased lengths.

3.3. Correlation Study

For the correlation studies, the data was initially organized according to the families they fall under. After this data set was run through the correlation analysis, the figures were re-organized by their respective species and were once again run through the correlation studies.

3.3.1 Price by Length of Fish

As organized by family, the correlation study showed a coefficient of 0.0152 or a negligible correlation, as illustrated in Figure 6, where the graph is almost parallel to the x-axis. But, when re-organized according to their respective species, 12 species showed a high to very high positive correlation between the length and price of fish sold in the market, as seen in Table 2.

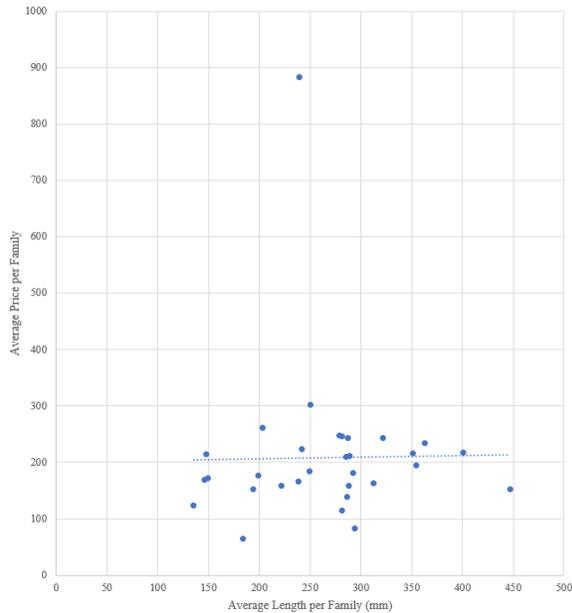

Figure 6. Effect of Average Length on Average Price Per Family

Table 2. Effect of Length on Price of Fish per Species

Species	Pearson's Correlation Coefficient	Interpretation
<i>Nibea soldado</i>	0.9981	Very high positive correlation
<i>Pomadasys argenteus</i>	0.9631	Very high positive correlation
<i>Pomadasys kaakan</i>	0.8267	High positive correlation
<i>Pterocaesio digramma</i>	0.9918	Very high positive correlation
<i>Stolephorus waitei</i>	0.9304	Very high positive correlation
<i>Priacanthus hamrur</i>	0.7917	High positive correlation
<i>Plectropomus leopardus</i>	0.7569	High positive correlation
<i>Selar crumenophthalmus</i>	0.9516	Very high positive correlation
<i>Lutjanus madras</i>	0.7321	High positive correlation
<i>Upeneus moluccensis</i>	0.9859	Very high positive correlation
<i>Sphyræna obtusata</i>	0.8042	High positive correlation
<i>Katsuwonus pelamis</i>	0.8041	High positive correlation

3.3.2. Price by Source of Fish

According to their respective families, the species under the families *Engraulidae*, *Priacanthidae*, and *Serranidae* showed a very high positive correlation, as shown in Table 3. This was interpreted as the source being a factor in the quality of the fish sold, which implies a higher price.

Table 3. Effect of Source on Average Price of Fish by Family

Family	Pearson's Correlation Coefficient	Interpretation
Engraulidae	0.9112	Very high positive correlation
Priacanthidae	0.9966	Very high positive correlation
Serranidae	0.9113	Very high positive correlation



Logistically, it is more efficient to source aquaculture from closer sources, such as Navotas or Malabon, both in Metro Manila. However, the quality of water found in these places is questionable. According to Santos et al. (2017), the presence of nitrates (N-NO₃) in the waters of Manila Bay exceeds the critical value dictated by ASEAN, which creates conditions that make it difficult for fish to live in. Likewise, this determines the degree of pollution in the area. In comparison, the water pollution levels of Metro Manila are at 83.56%, while that of Lucena is at 70.45% (Numbeo, 2021), making the aquaculture from Lucena safer and more fit for consumption. As per individual species, only *Priacanthus hamrur* showed a significant correlation value of 0.9966. This is because the species was sourced from three different locations but being the most expensive when sourced from Lucena.

3.3.3. Price Progression of Fish

Three representative species from each price range were included in the comparison so that all three price ranges would be constituted.

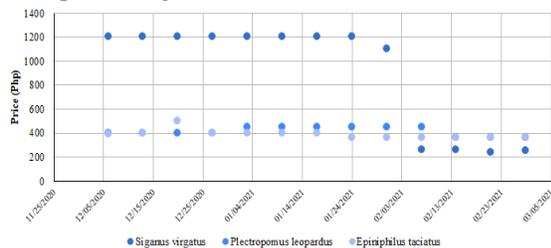

Figure 7. Price progression of three most expensive Species

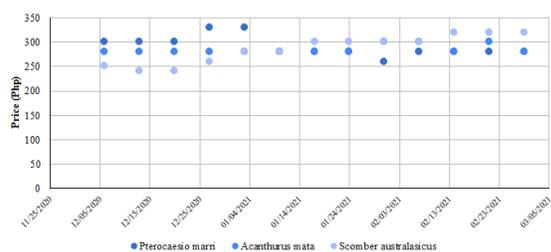

Figure 8. Price progression of three Mid-Range Species

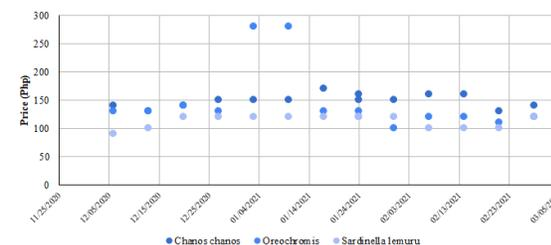

Figure 9. Price progression of three Least Expensive Species

The prices were at a steady constant in the more expensive range, except for *Siganus virgatus*, which experienced a steep drop, as seen in Figure 7. On the other hand, the mid-range priced species in Figure 8 showed a steady but significant increase in price, similar to those in the lower price range, as seen in Figure 9.

Despite the increase in species observed in the market, the prices are still steady despite the predicted decrease due to the supply-demand relationship. The cause of increased costs is the escalating difficulty in providing these quantities due to the rapid degradation of our aquatic ecosystems. According to Abreo (2018), the Pasig River alone contributes 3.21 x 10⁴ tons of plastic per year, and the interaction between marine biodiversity and this waste is inevitable. The proportion between habitable water and plastic waste is critical to the ecosystems where our fishermen are supposed to source their livelihood and is detrimental to both.

4. CONCLUSION AND RECOMMENDATIONS

In today's world, the rise of carbon emissions, waste products, and the like continue to threaten the sustainability and quality of the marine ecosystem, as observed in the results of this study. The market is more diverse than in the past; new species have been identified and successfully farmed. However, cross-regional transportation still poses a threat to the efficiency of the market, which in turn affects the processes of the economy. Since the aquacultural aspect of the biosphere is subject to change every day, monitoring the fish once per week may not be sufficient. To improve the research in possible future continuations, the researchers think that it is best to conduct the monitoring of the sector more frequently. In addition to this, the researchers believe that observing them in a laboratory to assess their overall health and condition will add a more in-depth assessment of the quality of fish in the study.

5. ACKNOWLEDGMENTS

The researchers would like to express their utmost gratitude to Dr. Allan N. Soriano from De La Salle University-Manila's Chemical Engineering Department for his constant direction and guidance during the composition of this paper. His approachability and generosity are unparalleled and simply superb.



6. REFERENCES

- Abreo, N. A. S. (2018). Marine plastics in the Philippines: A call for Research. *Philippine Science Letter*. 11, 20–21.
- Arcangel, R. S., Caleja, M. L., Ignao, A. A., & Orejudos, A. B. (2019). Characterization, Identification, and Effect of Size and Source or Traceability on the Price of Fishes Sold at Muñoz Market in Quezon City, Philippines. Unpublished study, Mapúa University.
- Bureau of Fisheries and Aquatic Resources (2020). *Philippine Fisheries Profile 2019*. Fisheries Planning and Economics Division. Quezon City, Philippines.
- Nasudi Soluta. (2021). Guard your heart this love month and beyond. Retrieved March 16, 2021, from National Nutrition Council website: <https://www.nnc.gov.ph/regional-offices/visayas/region-vii-central-visayas/4718-guard-your-heart-this-love-month-and-beyond>
- Numbeo. (2021). Pollution Comparison Between Manila, Philippines And Lucena, Philippines. Retrieved March 16, 2021, from Numbeo.com website: https://www.numbeo.com/pollution/compare_cities.jsp?country1=Philippines&country2=Philippines&city1=Manila&city2=Lucena&tracking=getDispatchComparison
- Ocean Conservation Trust. (2020, April 9). Coronavirus lockdown giving the world's oceans much-needed breathing space - *Environment Journal*. Retrieved March 23, 2021, from *Environment Journal* website: <https://environmentjournal.online/articles/coronavirus-lockdown-giving-worlds-oceans-much-needed-breathing-space/>
- Santos, M.D., Barut, N.C., & Bayate, A.D. (2017). *National Stock Assessment Program: The Philippine Capture Fisheries Atlas*. Bureau of Fisheries and Aquatic Resources – National Fisheries Research and Development Institute. Quezon City, Philippines.
- Santos, M.D., Furio, E.F., Lopez, G. DV., Torres, F. SB., Borja, V. M., Bognot, E. DC., Gatdula, N.C., Perez, M.A., & Gonzales, F.L. (2017). *Fisheries Resources and Ecological Assessment of Manila Bay 2012-2015*. Bureau of Fisheries and Aquatic Resources – National Fisheries Research and Development Institute. Quezon City, Philippines
- Valenzuela, R. I., Veluz, J. K., Villanueva, I. R., Villarama, K. M. (2020). A Comparative Study on the Effects of Size and Sources or Traceability on the Price of Identified Fish Species Sold at Muñoz Market, Quezon City. Unpublished study, De La Salle University



Potential Use of Morphological Characteristics in Evaluating Natural Variation of “Barako” Seedlings

Julienne Davis V. Aguilar, Denise Lindsey T. Kiok, Bernice Nicole I. Macalinao,
Ritchelle C. Ting and Khiyomi Hannah B. Uy
De La Salle University Integrated School, Manila

Abstract: The Philippines is one of only three countries able to produce *Coffea liberica* and grow two other species of coffee, *Coffea canephora*, *Coffea arabica*. *Coffea liberica*, or “Barako,” is the least cultivated of coffee species. Its unique taste has high potential to grow in the market if production was increased. However, the 2020 Taal Volcano eruption resulted in thousands of damaged Barako trees in 2020 and 2021. As new seedlings are produced, the question of variety among planting material comes up. Farmers need a method to evaluate natural differences of current Barako trees, to answer whether seedlings from farms cultivating Barako are naturally different. This research aims to determine if the morphological characteristics of cultivated seedlings from different farms can be classified through image and statistical analysis. Basic knowledge on how varieties—which produce different flavors, aroma, and market value of coffee—differ among farms is needed for a strategy to increase the number of seedlings. This study’s initial data set indicated statistically significant differences in the average seedling height per node and the leaf area per length of 31, 10-month old coffee seedlings from two different farms, grown in a common environment. The process may be developed further for use in evaluating natural variation among *C. liberica* as seedlings.

Key Words: coffee; barako seedlings; *Coffea liberica*; data analysis; morphological characteristics.

1. INTRODUCTION

Coffea liberica, commonly known as “Barako” coffee, is a species of coffee plant under the Rubiaceae family made known by William Hiern in 1876. *C. liberica* only accounts for about 1% of the Philippine’s coffee production, with *Coffea canephora* as the largest (Philippine Statistics Authority, 2019). Farmers replace their Barako with Robusta and short, hybrid coffee trees because of the surge in demand for instant coffee. With this problem, Barako has been facing difficulties finding its way onto the menus of mainstream coffee (Kapeng Barako, 2018).

The Philippines has a competitive advantage in the global production of *Coffea liberica*, being one of three countries—besides Ethiopia and Malaysia—that can produce *Coffea liberica* (Barako). *C. liberica* accounts for about 3-4% of overall coffee production in the world (Wallengren, 2018). With the current growing market for specialty coffee, *C. liberica* is finding new markets. The species, however, is on the verge of extinction, given very few farms exist. The Taal eruption during early 2020 in Batangas, a province famous for its production of Barako coffee, has further diminished the supply of Barako.

The value of coffee is dependent on its qualities. Variation in harvest quality results in price fluctuations where certain species are sold at higher or lower market prices. The same is true in many different plants, one of which is mangoes (Department of Agriculture, 2019). Certain varieties of mango are sold at higher prices. Farmers, sellers, and buyers base prices on morphological characters that distinguish types and product qualities. For coffee, the market of coffee beans and coffee seedlings is determined in the same way. Phenotypic characters of morphology and quality distinguish varieties grown in different areas. There are more long-term benefits for farmers and plant breeders to use physical characteristics because these are more practical (Kordrostami & Rahimi, 2015). Differences like seedlings (i.e., species, variety, or stock) may equate to differences in other qualities such as tastes, aroma, etc.

Since the Barako coffee has been in demand in the coffee market, the effort to increase seedlings of Barako production will benefit from information on knowing natural differences in Barako stocks. If farmers cultivate different stocks, it would make sense to tag each differently and see if there are corresponding differences in taste, disease

resistance, yield, etc. Hence, being able to differentiate the species of Barako based on the morphology of seedling and leaf characters would be necessary. The gold standard for this would be an analysis of genetic markers, but this would not be feasible for farmers. The process requires much training, equipment, and time, which are not necessarily available to farmers (Rahman et al., 2009).%

Image analysis programs and statistical tools were used to figure out morphological clusters formed from the data gathered. ImageJ is an image processing program capable of calculating area and pixel values of user-defined selections—measuring distances and angles (Bankhead, 2014). It can quantify or measure the plant’s visible traits, such as leaf morphology, to detect the link between its genome and its physiological characteristics (Kokorian et al., 2010). The study used 41 *Coffea liberica* (Barako) seedlings to undergo image analysis to differentiate its morphological characteristics, obtained from two farms grown in a controlled environment. This study was done with the approval of the research faculty responsible for the Senior High School students of DLSU. DNA markers were not used to verify whether the Barako seedlings are of different varieties.

The study can be of great help in assisting farmers, sellers, buyers of coffee in quickly determining *Coffea liberica* varieties. This can help in strategies to increase production of Barako, and hopefully the income as well of those involved in the industry; to encourage them to produce and preserve Barako. Doing so can prevent its decrease, meet the demand for new flavors in the coffee market, and improve the qualities of *C. liberica* varieties in the future.

2. METHODOLOGY

2.1. Sample Collection

A total of 41 ten-month-old *C. liberica* seedlings from 2 farms in Sarawak, Malaysia, were used as data for the morphological characteristics—31 for leaf area per leaf length and 41 for seedling height per seedling node. They were grown together in a controlled environment.

2.2 Data Collection

A camera was used to take images of these seedlings with a meter stick beside them to gather the height and number of nodes (Figure 2.2.1). Four to five leaves were collected by taking images in a parallel manner (Figure 2.2.2). The previously gathered 41 seedlings were named and segregated by category. Data collected from the coffee seedlings

and their leaves are added to Microsoft Excel for data analysis and graphs.



Figure 2.2.1 Seedling with the measuring stick



Figure 2.2.2 Sample Leaf with Ruler

2.3. Data Analysis

2.3.1. Mean and Standard Deviation

The mean was taken from the raw data of the four main characteristics in the seedlings to see the overall view of the seedlings in groups “Farm 1” and “Farm 2” and as a whole, “All Samples.” Standard deviation was also used to determine the closeness of the variables. A higher value for the standard deviation tells that the data is more spread out, while a smaller standard deviation tells the proximity of the data.

2.3.2. Histogram

The histogram was used to determine if two groups can be observed based on the standardized value of the morphological characteristics of the seedlings. If the type of histogram will be skewed to the left or skewed to the right, the data has a high correlation, and that the two groups are possibly



overlapping each other. If it is bimodal, it shows that there are indeed two groups due to a low correlation.

2.3.3. Scatterplot

The morphological characteristics of the seedlings and their respective leaves were compared in scatter plots to determine their correlation between each other. The correlation identifies if two groups exist and if these variables are applicable in the differentiation of morphology in *Coffea liberica* seedlings. High correlation is present if the data points are clustered together and have a large R² value. Low correlation within scatter plots is present if data points are scattered in a broader range, where it is possible to view two groups within the plot area. Indicated trendline acts as a divider to check for the visible possibility of two groups between the data points, along with the cluster of the data. Standardized values are not found in the scatter plots.

2.3.4. Paired T-Test

A Paired t-test was applied to determine whether there is a significant difference between the variability of the two farms based on the standardized values of Seedling Height per Seedling Node and Leaf Area per Leaf Length. When the T-test value is greater than the value from the distribution table, then the null hypothesis that the paired population is equal is rejected; if otherwise, accepted.

3. RESULTS AND DISCUSSIONS

3.1. Table of Means

The standardized values for both parameters, seedling height per nodes and area per length, shows that the means from Farm 1 is less than the mean for all the samples, while the means from Farm 2 is greater than the means for all samples. The table below (Table 3.1.1) showed that the mean for the seedlings in Farm 2 is taller than Farm 1. The values of the standard deviation of Farm 2 are more significant in most characteristics, except for the number of nodes and height per number of nodes. Higher standard deviation results in a more considerable variation of values, making it harder to differentiate due to a broader range of values.

Table 3.1.1 Table of Means

	Farm 1		Farm 2		All	
	Mean	SD	Mean	SD	Mean	SD
Height (cm)	19.2	5.4	26.9	8.03	21.5	8.7
No. of Nodes	5.8	1.4	6.3	1.2	5.9	1.4
Length (cm)	12.3	2.9	14.7	3.5	13.6	3.5
Area (cm ²)	43.8	20.7	63.1	31.7	54.7	29.1
Height per No. of Nodes	3.2	1.05	4.5	1.02	3.8	1.8
Area per Length (cm)	3.5	0.9	4.2	1.1	3.8	1.1

3.2 Scatter Plot

3.2.1. Leaf Length vs. Leaf Area

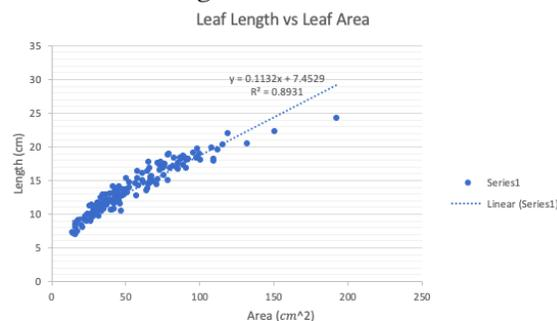

Figure 3.2.1.1 Scatter Plot of Leaf Length vs. Leaf Area

The graph (Figure 3.2.1.1.) shows a cluster with a high R² value of 0.8931, which indicates a high correlation. Due to this indication, these data sets cannot be used separately and must be standardized into “Leaf Area per Leaf Length.” While it is possible to use one, standardization is recommended due to the high correlation. Leaf length was used to standardize leaf area.



3.2.2. *Seedling Height vs. Seedling Nodes*

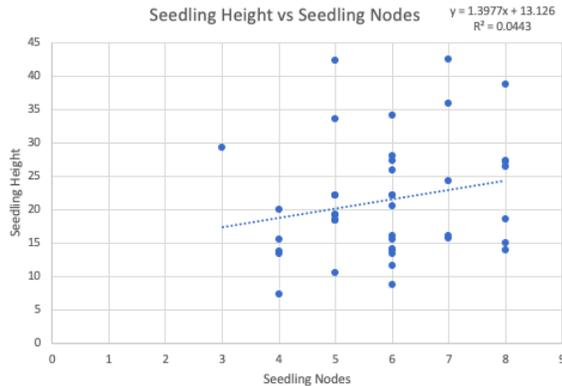

Figure 3.2.2.1 Scatter Plot of Seedling Height vs. Seedling Nodes

Data points (Figure 3.2.2.1.) between seedling height (y) and the number of nodes (x) present a wider spread of plot area covered, with less cluster between points. This low correlation is also shown with a smaller R^2 value of 0.0396, indicating that these variables have very high variability in the data. The separation gives them a significant variation, and it is difficult to compare the sets of data unless they are standardized into “Seedling Height per Seedling Nodes.” This resolves the wide variation that would otherwise make it challenging to compare height with nodes. It is also possible to use one variable, but the variation makes it difficult to choose. Therefore, a standardized value makes it easier to have both variables for the two groups of *C. liberica*.

3.2.3. *Comparison of data points from results of Farm 1 and Farm 2*

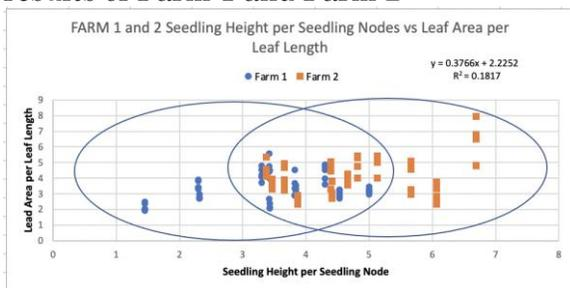

Figure 3.2.3.1 Comparison of data points from results of Farm 1 and Farm 2

Once the overall variables were standardized and combined, they appear to form two overlapping groups (Figure 3.2.3.1). Some variables from Farm 1 and Farm 2 have merged in the middle of the group (between the range of 3 to 5). Combining all characters measured produces a graph that shows groups. The two groups formed are Farm 1

(blue points) located on the leftmost and Farm 2 (orange points) on the rightmost. They are not enough to completely separate them into varieties. It is possible to investigate further the properties that would make the groups distinct by introducing more seedlings, characters, and farms.

3.3 *T-test*

The ability to determine differences in two groups using all the morphological characteristics measured is further emphasized through the T-test.

3.3.1. *Seedling Data for Height per Nodes*

Table 3.3.1.1 T-test data for Seedling Height per Nodes

	Farm 1	Farm 2
Mean (X)	3.1	4.6
Sample size (N)	14	13
Standard deviation (S)	1.4	1.05
Paired T-Test Value for Seedling Height per Nodes	3.0802	

When the seedling height by nodes of 14 seedlings from Farm 1 ($X_A = 3.1$, $S_A = 1.4$) and the data of the other 13 seedlings from Farm 2 ($X_B = 4.6$, $S_B = 1.05$) were compared, the resulting t-test value score was $t(12) = 2.306$, $p < .05$. This shows differences between the means, as the p-value or threshold acquired from the t-test table (2.306) is lower than that of the t-test score result (3.0802). Therefore, the null hypothesis stating that there is no significant difference between the two farms is rejected.

3.3.2. *Leaf Data for Area per Length*

Table 3.3.2.1 T-test data for Leaf Area per Length

	Farm 1	Farm 2
Mean (X)	3.4	4.1
Sample size (N)	55	63
Standard deviation (S)	0.9	1.09
Paired T-Test Value for Leaf Area per Leaf Length	3.7892	



Comparing the leaf area by length of 55 leaves from 11 seedlings from Farm 1 ($X_A = 3.4$, $S_A = 0.9$) with the data of the other 63 leaves coming from 13 seedlings of Farm 2 ($X_B = 4.1$, $S_B = 1.09$); the calculated t-test value score was $t(54) = 3.7892$, $p < .05$, indicating significant differences between the means. As the p-value or threshold acquired from the t-test table (2.0154) is lower than that of the t-test score result (3.7892), the null hypothesis that there is no significant difference between the two farms is rejected.

4. CONCLUSION AND RECOMMENDATION

The four parameters: seedling height, seedling nodes, leaf length, and leaf area, are best used as standardized values since it partially separates the groups. These then qualify as characteristics needed to carry out a paired t-test calculation—a statistical analysis done to determine differences between two variables of the same subject. After the seedling samples were classified into two groups, there was a significant difference between them; as two overlapping groups formed from the scatter plot (Figure 3.2.3.1). Thus, these indicate a potential of differentiation by using standardized morphological characteristics of seedlings grown in a controlled environment.

For future studies, it is recommended to get more seedling samples to test and gather more data to distinguish seedlings from various farms. Adding more morphological characteristics to separate further the groups, such as leaf apex, leaf margin, leaf venation, phyllotaxy, etc, is highly recommended. As suggested by the DLSU SHS Research Congress committee (personal communication, 2021; Nakano, as cited in KPU Pressbooks, 2020), morphological identification can also use flowers since it is said to be the part less affected by growth conditions. A larger population and other coffee seedlings will perhaps allow larger variation between *C. liberica* seedlings. Other farms can also be included, and their seedlings can be tested for variation or differentiation of their morphological characteristics, both with the existing parameters and additional ones.

5. ACKNOWLEDGMENTS

This research would not have been made possible without the devotion and assistance of their research adviser, Dr. Ma. Carmen Ablan-Lagman, Ph.D., who was also the provider of the coffee seedlings used in this research. For this, the group would like to express their deepest gratitude. She has shared her knowledge and experiences with the whole team, inspiring them to do better in all aspects

of research. They would also like to thank Dr. Chona Camille Vince Cruz-Abeledo, and Engr. Michael Manguerra, their Practical Research 1 and 2 professors, respectively, for teaching them the basics of research.

6. REFERENCES

- Bamber, P., Daly, J., & Gereffi, G. (2017, April). The Philippines in the Coffee Global Value Chain. <http://industry.gov.ph/wp-content/uploads/2017/08/The-Philippines-in-the-Coffee-Global-Value-Chain.pdf>
- Bankhead, Peter. (2014, June). Analyzing fluorescence microscopy images with ImageJ. https://www.researchgate.net/publication/260261544_Analyzing_fluorescence_microscopy_images_with_ImageJ
- Cao, E., Constantino-Santos, D. M., Ramos, L. A., Santos, B., Quilang, J., & Mojica, R. (2014, November 25). Molecular and morphological differentiation among *Coffea* (Rubiaceae) varieties grown in the farms of Cavite province, Philippines. *Philippine Science Letters*, 7(2), (pp. 387-397).
- Department of Agriculture. (2019, June 14). Philippine mango industry roadmap. <https://www.da.gov.ph/wp-content/uploads/2019/06/Philippine-Mango-Industry-Roadmap-2017-2022.pdf>
- Kapeng Barako: The Endangered Philippine *Liberica*. (2018, November 27). *Prima Donna Life*. <https://theprimadonnalife.com/lifestyle/kapeng-barako-the-endangered-philippine-liberica/>
- Kokorian, J. (2010, October 29). An ImageJ based measurement setup for automated phenotyping of plants. In G. Polder, J. J. B. Keurentjes, D. Vreugdenhil, & M. O. Guzman (Eds.), *Proceedings of the ImageJ User and Developer Conference*, Luxembourg, Luxembourg. (pp. 178-182). <https://library.wur.nl/WebQuery/wurpubs/398563>
- Kordrostami, M., & Rahimi, M. (2015, September 15). Molecular markers in plants: concepts and applications. *Genetics in The 3rd Millennium*, 13, (pp. 4024-4031).
- Nakano, M. (2020, February 13). Introduction to Plant Morphology [Red Seal Landscape Horticulturist Identify Plants and Plant Requirements (F2 - 1&2)]. KPU Pressbooks. <https://kpu.pressbooks.pub/plant-identification/chapter/introduction-to-plant-morphology/>
- Philippine Statistics Authority. (2020). Major non-food and industrial crops quarterly bulletin, October-December 2020. <https://psa.gov.ph/non-food/coffee>.
- Rahman, M., Zafar, Y., & Paterson, A. (2009, February 27). *Gossypium* DNA markers: Types, numbers, and uses. https://doi.org/10.1007/978-0-387-70810-2_5.
- Wallengren, P. B. M. (2020, May 10). Coffee of the day: The Elusive Philippines *Liberica* Barako Coffee Bean. Spilling the Beans. <https://philcoffeeboard.com/coffee-of-the-day-the-elusive-philippines-liberica-barako-coffee-bean/>
- Wintgens, Jean Nicolas (2004, July 27). Coffee: Growing, processing, sustainable production (A Guidebook for Growers, Processors, Traders, and Researchers). <https://doi.org/10.1002/9783527619627>.



A Systematic Review on Biosorption of Copper (II) ions in using Water Hyacinth as a Biomass

Kristen Carl S. Ona, Skyler D. Tapang, Nathan Jeremy V. Ang
De La Salle Integrated School, Manila

Dr. Allan N. Soriano
De La Salle University, Manila

Abstract: Due to the recent increase in the concentration of heavy metals in urban bodies of waters in the Philippines due to industrialization, the study sought to determine ideal methods of adsorbing these substances and prevent them from posing adverse health effects to surrounding communities. The method in the study reviewed the literature on using water hyacinth biomass as an adsorbent of heavy metals, specifically copper (II) or Cu(II), in contaminated areas susceptible to polluted wastewater runoff. With this, the ideal adsorbent was determined through factors of particle size, initial ion concentration, adsorption time, ideal conditions, and the adsorbent structure. From the reviewed studies, water hyacinth is an effective biosorbent for copper ions and can reduce copper concentrations in wastewater bodies. Ideal factors for maximum adsorption in terms of wastewater characteristics were conclusive amongst the chosen literature. Other parameters, however, require further investigation to determine if there are trends in how they affect adsorption capacity and removal percentage of the biomass.

Key Words: adsorption; batch process; biosorption; copper; water hyacinth

1. INTRODUCTION

The rise of industrialization has coincided with the increasing presence of heavy metal pollution. This increase occurred rapidly in the latter part of the 20th century in the 1980s and 1990s. A study conducted by Zhou and colleagues (2020) from 1972 to 2017 had determined that sources of the global increase in heavy metal concentration were mining, manufacturing, rock weathering, and agricultural runoff, depending on the region. It was also noted that these increases were more prevalent in developing areas, such as Africa, Asia, and South America, compared to developed regions like Europe and North America.

This development is detrimental to the Philippines as a country heavily reliant on its agricultural and fishery resources. In 2017, Perelonia and colleagues found that heavy metals lead (Pb), cadmium (Cd), and mercury (Hg) had the most notable presence in aquaculture farms and coastal areas in Manila Bay. Although there had been standards set by the Department of Environmental and Natural Resources (DENR) concerning what level of heavy metal presence is considered “safe,” in both the water itself and fish samples, several regions had failed to meet these standards during the country’s dry and wet seasons respectively.

In the past, water hyacinth has been used as an alternative, cost-efficient method of extracting heavy metals, specifically Cu(II). Research conducted by Saraswat and Rai (2010) examined and experimented on the adsorption capacities of water hyacinth to other heavy metals such as Cd, zinc (Zn), and chromium (Cr). Like these elements, Cu(II) has also shown the potential to be adsorbed by the water hyacinth under different conditions.

The study explored the capabilities of water hyacinth as biomass in the adsorption of heavy metals; specifically, Cu(II), an element found in high amounts in industrialized areas, is easily transmitted and poses serious health threats in high doses. It utilized quantitative studies that tested the capabilities of water hyacinth as an adsorbent of Cu(II) under varying conditions, such as the initial concentration of the heavy metal, the particle size of the water hyacinth biomass, and the amount of time which the adsorbent is placed in the heavy metal solution.

2. METHODOLOGY

The data from other related studies were compared and analyzed for accuracy in creating an effective water hyacinth adsorbent model. The criteria adapted from the data involved the following factors: initial metal ion concentration, ideal water conditions,



adsorbent structure, adsorbent particle size, and adsorption time. These factors were chosen as they were related to the adsorption process of the water hyacinth and the efficiency in making the ideal model. Following the methods from similar literature, the study focused on a batch procedure for the analysis.

Electronic studies were searched through available databases. The following databases were searched without language, publication year, or publication status restrictions:

- EBSCO Research Databases via the De La Salle University Libraries (Searched March 22, 2021)
- ScienceDirect via the De La Salle University Libraries (Searched March 22, 2021)
- Scopus via the De La Salle University Libraries (Searched March 22, 2021)
- Google Scholar (March 22, 2021)

3. RESULTS AND DISCUSSIONS

3.1. Water Hyacinth Biomass as an adsorbent for copper(II) ions

Many biosorption studies involving Cu(II) ions utilized dried and groundwater hyacinth. Grinding the biomass increases the surface area, which results in optimal metal adsorption. Gandhimathi and colleagues (2013) also used the acid treatment on the biomass. All forms of biosorbent showed effective adsorption of Cu(II) ions, the highest removal percentages at 98.8%, 98.19, and 95.1%, as seen in Table 1. (Gandhimathi et al., 2013; Oktaviana Lussa et al., 2020; Sadeek et al., 2015; Singa & Das., 2013).

Table 1. Batch Process Adsorption using Water Hyacinth Biomass

Biosorbent Form	Optimal Parameters	Adsorption Capacity	Removal Rate	Reference
Acid-treated	pH 7 10mg/L Cu(II) solution (100 mL) 0.1g/100 mL biomass concentration 300µm - 600µm particle size 75 minute contact time	6.56 mg g ⁻¹	89.04%	Gandhimathi et al. (2013)
Leaves, Shoots	250 mL Cu-wastewater 10 g biomass Sieved with 100 meshes 1 hour contact time	22.19 mg g ⁻¹	98.19%	Oktaviana Lussa et al. (2020)
Roots	pH 5 100 mg/L Cu(II) concentration 1 g/100 mL biomass concentration 300µm - 600µm particle size 30°C 20 minute contact time	32.51 mg g ⁻¹	80%	Li et al. (2013)
Roots	pH 5.5±0.5 20 mg biomass 50 mL Cu(II) solution, varying concentrations	22.7 mg g ⁻¹	>75%	Zheng et al. (2009)

	Biomass cut into segments			
Roots	25 mg/L Cu(II) concentration adsorbent 10 g/L biomass concentration 250-350 µm particle size 5 hour contact time	21.80 mg g ⁻¹	>95%	Singha & Das (2013)
Whole Biomass	pH 7 10mg/L metal ion solution, 100 mL 0.1g/100 mL biomass 300µm - 600µm particle size 60 minute contact time	0.49 mg g ⁻¹	65.93%	Gandhimathi et al. (2013)
Whole Biomass	pH 7 0.5-1mm particle size 25°C 4 hour contact time	181.8 mg g ⁻¹	95.1%	Sadeek et al. (2015)
Whole Biomass	pH 9 0.5-1mm particle size 25°C 3 hour contact time	181.8 mg g ⁻¹	98.8%	Sadeek et al. (2015)

When exposed to solutions with several metal ions, the biomass also tends to adsorb ions with a higher ionic radius as they have a greater affinity for adsorption binding sites (Saraswat & Rai, 2010). Compared to other biosorbents, water hyacinth achieves a higher removal percentage at lower pH levels and reaches equilibrium at pH 5 (Husoon et al., 2013; Singa & Das, 2013).

3.1.1 Roots versus Aerial Parts for Adsorption

Table 2. Accumulation of Cu(II) in Water Hyacinth parts

Heavy Metal Concentration	Concentration in Water Hyacinth (µg g ⁻¹ dry matter)						
	1 mg l ⁻¹	3 mg l ⁻¹	5 mg l ⁻¹	7 mg l ⁻¹	10 mg l ⁻¹	50 mg l ⁻¹	100 mg l ⁻¹
Aerial Part	57	68	252	1105	700	1525	1900
Roots	1750	2110	2710	2750	2900	2950	2800

Note. Data was retrieved from Soltan and Rashed (2013).

Several studies utilize either roots or aerial parts; however, limited studies compare the adsorption capabilities of different water hyacinth parts under similar conditions. Soltan and Rashed (2003) explored the adsorption capacities of both root and aerial parts in mixed metal solutions containing Cd, Co, Cr, Cu, Mn, Ni, Pb, and Zn at different metal concentrations. They concluded that roots have higher adsorption capacity than aerial parts as seen in Table 2.

3.1.2 Effect of Biomass Concentration on Cu(II) Adsorption

Biomass concentration may also affect the removal rates during metal adsorption. Gandhimathi and colleagues (2013) found that the Cu(II) adsorption percentage increases as the biomass concentration



increases from 0.2 g/L until reaching an optimal concentration of 1.6 g/L with a removal percentage of 74.12% for whole biomass and 92.01% for acid-treated biomass, as seen in Figure 1. Increasing the biomass concentration greater than 1.6 g/L yields almost no increase in removal percentage. This is supported by Oktaviyana Lussa and colleagues (2020), who tested three amounts of biomass (10 g, 15 g, 20 g) for copper adsorption in 250mL wastewater mainly containing Cu(II) ions. Although there were minimal differences in adsorption percentage, as seen in Table 3, these two studies depict a trend wherein increasing the biomass concentration beyond a certain point will negatively affect the resulting adsorption percentage due to interference in the number of active bonding sites of the adsorbent.

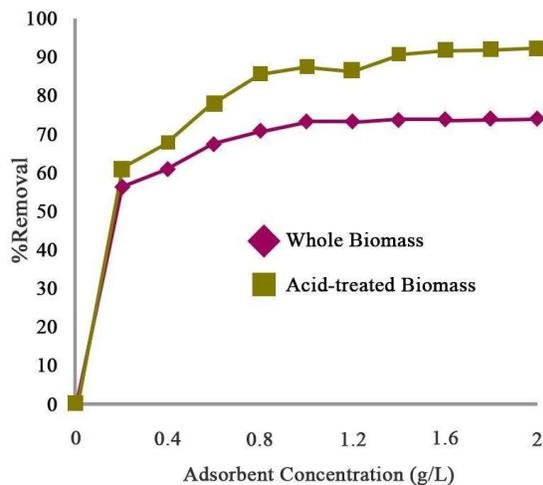

Figure 1. Effect on Biosorbent concentration on Adsorption Percentage
 Note. Data retrieved from Gandhimathi et al. (2013).

Table 3. Effect of Mass adsorbent on Cu(II) Adsorption

Mass Adsorbent	Adsorption Percentage		
	30 min contact time	60 min contact time	90 min contact time
10 g	97.9626 %	98.1918 %	97.9741 %
15 g	96.7479 %	98.1345 %	97.9282 %
20 g	97.6990 %	98.0886 %	97.9168 %

Note. Data retrieved from Oktaviyana Lussa et al. (2020).

3.2 Ideal Wastewater Conditions

From the various studies gathered within the review of related literature, the ideal wastewater conditions revolve primarily around the pH level and initial metal ion concentration. These factors affect the quantity of water hyacinth capable of adsorbing until it reaches the maximum capacity (Saraswat & Rai, 2010). By manipulating how the water hyacinth

attracts and binds to the ions, the ideal wastewater conditions will provide an optimal medium for the adsorption of Cu(II) and the adsorbent. Choosing the most favorable condition for the water hyacinth increases the maximum capacity, contributing to greater adsorption capabilities.

3.2.1 pH Level

The pH level of the wastewater can manipulate the surface charge and the solubility of the adsorbent (Smičiklas et al., 2008). Li et al. (2013) used pH levels 1-7 for Cu(II) adsorption using water hyacinth root powder. Throughout the adsorption process, they observed an optimal pH level of 5; however, pH 6 and 7 also followed a similar yield in adsorption percentage as the optimal pH level. This dependence may be attributed to the accessible hydroxide or carboxylic acid. Zheng et al. (2009) determined that the adsorption of copper (II) through water hyacinth roots with an initial pH of 4.5 was optimal in reaching maximum capacity due to the hydrogen ions that act upon the surface charge of the adsorbent. Additionally, another observation suggested that a decrease in maximum capacity starts after pH goes beyond 5.7. Pisitsak et al. (2019) explained the adsorption efficiency at the pH of 4.63 that was determined through a batch adsorption technique. In another study, Lu et al. (2014) used live water hyacinth plants for copper removal and wastewater maintenance. Due to water loss caused by evaporation, transpiration, and water testing, the pH had to be consistently maintained at a pH of 6 daily by adding 1.0 M HCl and NaOH to produce optimal results. A 2016 study by Zheng et al. tested a lowered pH of 3 and noticed a complete lack of adsorption amount for cadmium and a significant decrease in copper and found a range of 5.5 ± 0.05 to be optimal. The summary of the optimal pH used by the studies is shown in Table 4.

Table 4. Optimization of pH Level

Biosorbent Form	Optimal pH Used	Reference
Live Plants	6	Lu et al. (2014)
Plant Fibers	4.63	Pisitsak et al. (2019)
Roots	5.7	Zheng et al. (2009)
Roots	5.5 ± 0.05	Zheng et al. (2016)
Root Powder	5	Li et al. (2013)

The various studies showed that optimizing the pH level can be narrowed down for the adsorption process, with each study presenting an optimal pH range of roughly 4.5 to 5.5. Through experimentation, Li et al. (2013) determined a pH level of 5 as optimal with only minor outliers using 6 and 7. Lu et al. (2014) was an outlier using a pH level of 6, possibly because



of the use of live water hyacinth instead of its biomass forms.

3.2.2 Initial Metal Ion Concentration

Saraswat & Rai (2010) mentioned initial metal ion concentration as an essential adsorption parameter because it is dependent on the absorptive surface area of the water hyacinth biomass. In turn, this would affect the saturation of the binding sites if the initial ion concentration were to be increased. This is evident in the study of Singha & Das (2013), which observed that an increase from 5 mg/L to 300mg/L would result in a lower percentage removal, showing a lower concentration would result in the majority of the ions stuck to the binding sites; whereas, a higher concentration would saturate the binding sites and leave excess copper ions in the solution.

A 2008 study by Mishra & Tripathi tested the adsorption capabilities of water hyacinth on five different heavy metals using 100g of live water hyacinth in 10L of water with varying initial ion concentrations. Once again, this study showed that adsorption capacity increases as initial ion concentration decreases. It tested initial copper ion concentrations of 1.0, 2.0, and 5.0 mg/L, resulting in 95%, 89% and 86% adsorption capacities, respectively. Similarly, another study made by Mokhtar et al. (2011) also analyzed the initial ion concentration, the range including 1.5, 2.5, and 5.5 mg/L. Using 250g to 300g of live water hyacinths in 8 L of water with the metal ions, the best result was done with 1.5mg/L with 97.3%, and the worst observed concentration was 5.5mg/L with 61.6%.

3.3 Metal Ion Adsorption Process

The experimentation process itself provides several factors that could affect both adsorption percentage and efficiency. These variables are controlled, such as the contact time allowed between the adsorbent and adsorbate. Alternatively, this could also apply to a mechanical filtering process using a filtration column should the study choose to do so.

3.3.1 Contact Time

Contact between the solution and the biomass was often facilitated using incubator shakers at varying speeds and temperatures. While the agitation and its resultant heating of the solution would encourage adsorption, this did not guarantee the highest possible adsorption rate after the solution had reached equilibrium. Q_e represented this in Table 5, the equilibrium adsorption capacity calculated from a pseudo-second-order kinetic model as this equation was used amongst all the chosen studies.

Table 5. *Effect of Agitation and Contact Time on Cu(II) Adsorption*

Rotation Speed	Temperature	Time	Q _e	Reference
175 rpm	303K	20 min	13.15 ± 0.26	Li et al., (2013)
150 rpm	308K	20 min	24.3	Zheng et al., (2009)
150 rpm	-	5 hr	5.74 (RWH) 9.06 (TWH)	Gandhimathi et al., (2013)

According to the studies conducted by Li et al. (2013) and Zheng et al. (2009), respectively, the maximum adsorption rate was reached within 30 minutes, even peaking after as early as 20 minutes of reaction time. This was contested only by Gandhimathi et al.'s study that used a predetermined reaction time of 5 hours, which resulted in the lowest Q_e value for both types of water hyacinth used in that particular study (raw and acid-treated).

3.3.2 Filtration Column

Mahamadi and Zambara's (2013) study showcased how mechanical filtration could lead to build-up and exhaustion of the biomass before reaching its total adsorption capacity. This filtration setup used the same amount of adsorbent for bed depths of two different measurements: 6.5 cm and 14 cm. The more tightly packed bed depth of 6.5 cm had allowed for the rapid accumulation of Cu within the filtration setup and the exhaustion of the biomass at around 20 hours. However, using a higher bed depth prevented the premature exhaustion of the adsorbent as it was looser and had made more adsorption sites available.

4. CONCLUSION

Water hyacinth is an effective biosorbent for the reduction of copper concentrations in wastewater bodies. Maximizing adsorption capacity and removal percentage in applications requires several factors to be considered. Certain parts of the biomass may result in better outputs. Roots are often preferred over aerial parts; however, limited studies exist comparing the adsorption capacities of parts under the same conditions. The amount of biomass utilized must also be optimized for efficiency as excessive biomass will result in saturation of adsorption sites leading to a limited increase in adsorption and waste of material. Wastewater conditions are also vital. Optimal adsorption results are often produced within pH 4-7, with pH 5 commonly cited as the point of significant increase. Metal ion concentration in the water can also affect removal percentage. Longer contact time during agitation does not garner better adsorption results, thus requiring more studies under the same testing conditions. Alternatively, results while using a filtration column heavily depend on its bed depth. It



recommends loosely packing the biosorbent at a higher bed depth, without much emphasis on the height of the setup itself or how much time was spent in contact with it.

5. ACKNOWLEDGMENTS

The researchers would like to extend their deepest gratitude to Dr. Allan Soriano from the Chemical Engineering Department of the Gokongwei College of Engineering of De La Salle University-Manila for his unwavering support and exemplary guidance throughout this study. His involvement in the development of this manuscript reflects his unparalleled dedication and generosity as an educator.

6. REFERENCES

- Gandhimathi, R., Ramesh, S. T., Arun, V. M., & Nidheesh, P. V. (2013). Biosorption of Cu(II) and Zn(II) ions from aqueous solution by water hyacinth (*Eichhornia crassipes*). *International Journal of Environment and Waste Management*, 11(4), 365-386. <https://doi.org/10.1504/IJEWM.2013.054243>
- Husoon, Z.A., Al-Azzawi, M.N.A., & Al-Hiyaly, S.A.K. (2013). Investigation biosorption potential of copper and lead from industrial wastewater using orange and lemon peels. *Al-Nahrain University Journal for Science*, 16(2), 173-179. <https://doi.org/10.22401/JNUS.16.2.27>
- Li, X., Liu, S., Na, Z., Lu, D., & Liu, Z. (2013). Adsorption, concentration, and recovery of aqueous heavy metal ions with the root powder of *Eichhornia crassipes*. *Ecological Engineering*, 60, 160-166. <https://doi.org/10.1016/j.ecoleng.2013.07.039>
- Liu, L., Luo, X.-B., Ding, L., & Luo, S.-L. (2019). Application of nanotechnology in the removal of heavy metal from water. *Nanomaterials for the Removal of Pollutants and Resource Reutilization*, pp. 83-147. <https://doi.org/10.1016/B978-0-12-814837-2.00004-4>
- Lu, X., Gao, Y., Luo, J., Yan, S., Rengel, Z., & Zhang, Z. (2014). Interaction of veterinary antibiotic tetracyclines and copper on their fates in water and water hyacinth (*Eichhornia crassipes*). *Journal of Hazardous Materials*, 280, 389-398. <https://doi.org/10.1016/j.jhazmat.2014.08.022>
- Mahamadi, C., & Zambara, P. (2013). High cu removal from water using water hyacinth fixed on alginate. *Environmental Chemistry Letters*, 11(4), 377-383. <https://doi.org/10.1007/s10311-013-0418-2>
- Mishra, V. K., & Tripathi, B. D. (2008). Concurrent removal and accumulation of heavy metals by the three aquatic macrophytes. *Bioresource Technology*, 99(15), 7091-7097. <https://doi.org/10.1016/j.biortech.2008.01.002>
- Mokhtar, H., Morad, N., & Fizri, F.F. (2011). Hyperaccumulation of copper by two species of aquatic plants [Paper Presentation]. *IPCBE 2011 International Conference on Environment Science and Engineering*, Singapore. <http://www.ipcbee.com/vol8/26-S067.pdf>
- Oktaviyana Lussa, M., Wijayanti, A., Ayu Kusumadewi, R., & Hadisoebroto, R. (2020). The mixing speed effect and mass of adsorbent on copper (Cu) removal from wastewater by water hyacinth leaves. Paper presented at the E3S Web of Conferences, 148. <https://doi.org/10.1051/e3sconf/202014805006>
- Perelonia, K. B., Abendanio, C., Raña, J., Opinion, A. G., Villeza, J., and Cambia, F. (2017). Heavy metal contamination in water and fishery resources in Manila Bay aquaculture farms. *The Philippine Journal of Fisheries*, 24(2), 74-97. <https://doi.org/10.31398/tpjf/24.2.2016A0014>
- Pisitsak, P., Phamonpon, W., Soontornchatchavet, P., Sittinun, A., Ummartyotin, S., Buajarern, S., & Inprasit, T. (2019). The use of water hyacinth fibers to develop chitosan-based biocomposites with improved Cu²⁺ removal efficiency. *Composites Communications*, 16, 1-4. <https://doi.org/10.1016/j.coco.2019.08.003>
- Saraswat, S., & Rai, J. (2010). Heavy metal adsorption from aqueous solution using *Eichhornia crassipes* dead biomass. *International Journal of Mineral Processing*, 94(3-4), 203-206. <https://doi.org/10.1016/j.minpro.2010.02.006>
- Sadeek, A., Negm, N., Hefni, H., & Abdel Wahab, M. (2015). Metal adsorption by agricultural biosorbents: Adsorption isotherm, kinetic and biosorbents chemical structures. *International Journal of Biological Macromolecules*, 81, 400-409. <https://doi.org/10.1016/j.ijbiomac.2015.08.031>
- Singha, B., & Das, S. (2013). Adsorptive removal of Cu(II) from aqueous solution and industrial effluent using natural/agricultural wastes. *Colloids and Surfaces B: Bioninterfaces*, 107, 97-106. <https://doi.org/10.1016/j.colsurfb.2013.01.060>
- Smičiklas, I., Onjia, A., Raičević, S., Janačković, Đ., & Mitrić, M. (2008). Factors influencing the removal of divalent cations by hydroxyapatite. *Journal of Hazardous Materials*, 152(2), 876-884. <https://doi.org/10.1016/j.jhazmat.2007.07.056>
- Soltan, M. E., & Rashed, M. N. (2003). Laboratory study on the survival of water hyacinth under several conditions of heavy metal concentrations. *Advances in Environmental Research*, 7(2), 321-334. [https://doi.org/10.1016/S1093-0191\(02\)00002-3](https://doi.org/10.1016/S1093-0191(02)00002-3)
- Sparks, D. (2003). Sorption phenomena on soils, In D. Sparks (Ed.), *Environmental Soil Chemistry* (2nd Ed., pp. 133-186). <https://doi.org/10.1016/B978-012656446-4/50005-0>
- Woody, C. A., & O'Neal, S. L. (2012). Effects of copper on fish and aquatic resources. <https://www.conservationgateway.org/ConservationByGeography/NorthAmerica/UnitedStates/alaska/sw/cpa/Documents/W2013ECopperF062012.pdf>
- Zheng, J., Feng, H., Hon-Wah Lam, M. Kwan-Sing Lam, O., Ding, Y., & Yu, H. (2009). Removal of Cu(II) in aqueous media by biosorption using water hyacinth roots as a biosorbent material. *Journal of Hazardous Materials*, 171(103), 780-785. <https://doi.org/10.1016/j.jhazmat.2009.06.078>
- Zheng, J., Liu, H., Feng, H., Li, Wen., Hon-Wah Lam, M., Kwan-Sing Lam, P., & Yu, H. (2016). Competitive sorption of heavy metals by water hyacinth roots. *Environmental Pollution*, 219, 837-845. <https://doi.org/10.1016/j.envpol.2016.08.001>
- Zhou, Q., Yang, N., Li, Y., Ren, B., Ding, X., Bian, H., Yao, X. (2020). Total concentrations and sources of heavy metal pollution in global river and lake water bodies from 1972 to 2017. *Global Ecology and Conservation*, 22. <https://doi.org/10.1016/j.gecco.2020.e00925>



Designing a Tensegrity Form of an Outdoor Hydroponic System Utilizing Bamboo (*Bambusoideae*) and Abaca Fiber (*Musa textilis*)

Lara Isabelle M. Cabral, Claire Anne S. Magtibay,
and Liza Marie T. Rosales
De La Salle University Integrated School, Biñan City, Laguna

Abstract: The COVID-19 pandemic has caused unemployment and a lack of food. Filipinos have turned to indoor and outdoor gardening as an alternative source of income and food. However, one of the problems faced by home gardeners is space insufficiency. This research aims to find a solution to this problem by designing an outdoor tensegrity hydroponic system and constructing its model using Bamboo (*Bambusoideae*) and Abaca Fiber (*Musa textilis*). The research followed a system called the ADDIE Model to execute its methodology. The dimensions of the tensegrity hydroponic system design were planned during the Analysis phase. Freehand sketches of proposed designs were created during the Design phase. The three chosen proposed designs were rendered using Sketch-up in the Development phase. The best design was picked by comparing the three proposed designs in FreeCAD. The selected design was constructed in the Implementation phase and was evaluated during the Evaluation phase. The chosen design, table-top design, had the highest pascals (Pa) under a Generic Wood stressor in the Von Mises Stress test. The structure maintained its balance and withstood a load of three liters of greywater.

Key Words: tensegrity; hydroponic system; bamboo; abaca; COVID-19

1. INTRODUCTION

The COVID-19 pandemic is an ongoing crisis that caused a halt in the cycle within the labor market and economic activities. Businesses began to close and were the cause of mass unemployment. Some Filipinos turned to indoor and outdoor gardening as an alternative source of income and food. It has also become an option for farmers to also sell their harvests through e-commerce or online selling (Oxford Business Group, 2020). Gardening is more than just cultivating plants; being exposed to nature creates a feeling of belongingness for those who feel anxious as the COVID-19 crisis becomes more apparent. Space insufficiency for gardening is also a problem of urban housings like apartments (Sofa & Sofa, 2020). An efficient solution for space insufficiency is to use hydroponic systems to occupy small spaces in urban, suburban, and rural residential areas (Grady, 2020). It is composed of stacked layers that promote high crop yield even in smaller sizes. Hydroponic systems can cultivate many plants like herbs and vegetables (Modular Hydro, n.d). With the condition of today's societal needs, growing officinal plants can improve a person's overall health because of the vitamins and minerals it provides (Bri, 2017).

Designing an outdoor hydroponic system while incorporating tensegrity creates a more space-efficient, lightweight, and aesthetic structure in the garden that maximizes space utilization, food

production, and consumption. The components of a tensegrity system are under compression and tension even if they are not touching. This discontinuous appearance creates a floating impression. The strings are at a state of uncertainty within the system, while the bars are at a state of compression, resulting in a balanced and stable structure in space (Arjun, n.d).

Due to the present situation, an actual outdoor tensegrity hydroponic system is limited to a trial-and-error model. The tensegrity hydroponic structure will be composed of indigenous materials: bamboo (*Bambusoideae*) as the bar or compressed materials and abaca (*Musa textilis*) as the tensioned string. The constructed hydroponic system will serve as the experimental model representing how tensegrity appropriately applies in the proposed design. Load capacity and balance will be collected through a simulation in FreeCAD, while design modeling was done on SketchUp. As of the moment, there are no studies applying tensegrity structures to a hydroponic system. In this paper, the researchers aim to achieve the following:

- a. Design a space-efficient and stable tensegrity hydroponic system for outdoor gardening.
- b. Prove that the tensegrity structure is an appropriate alternative structure for the hydroponic system by subjecting it to the Von Mises Stress and load capacity test.
- c. Demonstrate that using indigenous materials such as bamboo and abaca fiber are suitable



substitute materials for the standard hydroponic systems.

2. METHODOLOGY

2.1 Materials

In constructing the outdoor tensegrity hydroponic system, the primary materials used were bamboo and 3-ply abaca fiber. Three straight PVC pipes (1.4-inch diameter, 4-inch length), six elbow pipes (1.5-inch diameter, 2-inch length), plastic containers, wood glue, and eye hooks were also used.

2.2 The ADDIE Model

The researchers integrated a systematic design model involving Analysis, Design, Development, Implementation, and Evaluation (ADDIE). Continuous analyses of the designs' needs and objectives were made for new developments to happen. ADDIE model ensures that the product is deemed effective by the target audience and beneficiaries. Alongside the ADDIE design process is the Human-Centered Design Thinking Process (HCDTP), providing that the proposed design will be relevant and beneficial for a long time (Hoover, 2018).

2.2.1 Analysis and Design

Through the Analysis method, individual and societal needs were determined. Analysis of the outdoor tensegrity hydroponic structure considered the following factors: size, color, shape, and space. Color and ergonomics analysis was done to determine the impression and human comfortability given by the given product.

The Design phase involved daily brainstorming of rapid freehand sketches for a total of one week. The morphology method focused on laying out and organizing the parts involved in the exterior and interior designs of the structure.

2.2.2 Development

The 15 freehand rapid sketches were evaluated and narrowed down into three designs. The three designs were modeled and rendered in SketchUp. The designs underwent experimentation in FreeCAD and the least displaced under stress, and most durable was determined as the final design.

2.2.3 Implementation

This phase included the model construction of the chosen final design in the Development phase. Load capacity was measured by applying varying

liters of water in the basin until a maximum load is reached.

2.2.4 Evaluation

The design's overall aesthetic appearance and tensegrity form were evaluated in balance, space efficiency, and load capacity.

3. RESULTS AND DISCUSSIONS

3.1 Analysis

The stated factors above were considered while doing the 15 freehand rapid sketches. The researchers made the height of the structure capable of reach with no experience of body discomfort among its users. The structure's color was green to represent peacefulness and nature (Love Nest Design, 2017). Different base shapes were designed to compare sturdiness. A vertical hydroponic system was recommended because it uses smaller spaces compared to those oriented horizontally. Abaca strings on the left and right sides of the structure were aligned to maintain balance.

3.2 Design

The main features of the exterior sketches were the top and base platforms. The platforms were designed in regular shapes like a triangle, rectangle, and square, depending on the allocated space at home. Different positions for the bamboo and abaca strings were sketched depending on the base shape. Meanwhile, the main features of the interior sketches were the water pipe placement and water reservoir placement. The bamboos were bored with two to three holes accommodating two to three plants. Containers were placed at the top and bottom platforms for storage and drainage. Figure 1 shows the 15 rapid sketches.



Figure 1. 15 Freehand Rapid Sketches

3.3 Development



Figure 2. Three Chosen Designs Modeled in SketchUp

Figure 2 showed the three chosen designs modeled in SketchUp from the 15 rapid sketches. The three designs were selected because of their aesthetics and capability to store more plants. They were also chosen because they are space-efficient vertical hydroponic systems.

Through the Finite Element Method (FEM) in FreeCAD, the load capacity of the three final designs was calculated. The results in FreeCAD were merely theoretical and only served as a basis for identifying which design is the most durable or most deformed. The Von Mises Stress was used to determine if the chosen material will yield or fracture (Simscale, n.d.).

Table 1. Theoretical Results on Stress and Displacement Experienced Gathered from FreeCAD.

	Table-top Design	S Design	Triangular Design
Von Mises Stress Applied By Generic Wood Stressor			
Displacement Caused by Generic Wood Stressor			

In Table 1, the table-top design was the least to experience deformation and maintained its structure when under the Generic Wood stressor. Due to the table-like appearance, the supporting abaca strings at four corners were able to prevent deformity. When the Von Mises Stress from Generic Wood was applied, the table-top design had the highest average load capacity of 1125.04 Pa (refer to Table 2). Higher Pascal (Pa) means that the structure can hold higher pressure or stress. As a result, a table-top design was chosen for scale modeling.

Table 2. Theoretical Results on Load Capacity Gathered from FreeCAD

	Table-top Design	S Design	Triangular Design
Average Load Capacity with Generic Wood Stressor (Density: 700.00 kg/m ³)	1125.04 Pa	81.41 Pa	363.09 Pa

The data about the tensile strength of the bamboo and abaca fiber was gathered from previous studies because a Universal Testing Machine (UTM) was not accessible at the time.

3.4 Implementation

Lashing the abaca strings to the bamboo was done to strengthen the model. Green paint was applied to the structure. The size of the model was 19 inches wide, 38 inches long, and 28 inches high. The model's balance was observed to ensure that the concept of tensegrity was applied correctly. The gravity-fed system allowed the water to travel down to the bottom basin and reach the bottom of the punctured disposable cups placed in the holes of the bamboos in the middle. Since the design is relatively open on all four sides, accessing the plants was not a problem. The user must also squat or kneel to access the plants once the hydroponic structure is set down on the ground. A space-efficient hydroponic system was achieved since the knots of the abaca string tied in the eye hooks can be untied if not used and when it occupies small spaces.

3.5 Evaluation

The structural form of the final design was assessed by discussing why a specific bar and string positioning was the most space-efficient and durable. Adjustments and revisions were made to improve its structure and functions.



Figure 3. The model (perspective) before modifications

The model of the tensegrity hydroponic system was able to balance. The tensioned string at both sides' middle of the two bamboo columns did not snap or break. The four supporting strings at the four edges also did not fracture under pressure even though the top platform was made of wood weighing two kilograms (Figure 3).

A 3-ply abaca string was applied to the model instead of a 5mm and 8mm abaca string because a thinner string can be easily adjusted. Before the modification, the bamboos that were connected to the base of the structure had inaccurate measurements. The elbow pipes inserted on the end of the bamboo were too small and resulted in dripping water on the side of the bamboo. After evaluation, the measurements of the bamboo columns were reduced.

The length of the bamboo columns at the side was decreased by 1.5 inches because the model did not create a floating impression at first. During the second construction phase, all the abaca strings were adjusted appropriately, and duct tapes were no longer needed (Figure 4). The structure was able to withstand pressure without fracture from the bamboo and abaca. It was also required to tie the abaca strings while two or more people equally balanced the structure on its center of gravity. The structure successfully portrayed a floating impression after modifications.



Figure 4. *The model (front view) after modifications*



Figure 5. *Testing sunlight exposure on the structure*

Figure 5 shows that all hanging bamboo poles are reached by sunlight from 7:30 AM to 11:30 AM. The user can move the structure at any position and direction it faces the sun. The model could withstand an approximate load of three liters of greywater in a basin at the top platform.

Herbs were not cultivated because that has already been proven in multiple designs from other creators. The abaca strings that connect the columns create a pull-push phenomenon while finding its center of gravity wherein the upper part of the compressed column pushes the abaca string down. In contrast, the compressed lower column pulls it, therefore creating tension and balance. The same phenomenon happens at the strings on the four edges of the structure. When the strings on any of the corners are pulled, strings opposite it are stretched, making the structure not fall on one side. Also, if the table is left only with a single string attached to the middle, it will eventually fall in a pendulum motion.

4. CONCLUSION AND RECOMMENDATIONS

The COVID-19 pandemic limited the sources for food and income. Individuals turned to home gardening; however, lack of space was a problem identified. A space-efficient and stable model of an outdoor tensegrity hydroponic system was designed in Sketchup and tested in FreeCAD. The process followed the ADDIE model, which began with rapid sketching that was further narrowed to the final design until it was constructed and evaluated. The Von Mises Stress and load capacity test results proved that the table-top design incorporated with tensegrity is an alternative structure for a hydroponic system. The constructed table-top model used bamboo and abaca fiber and proved its durability under stress and compression.

A recommendation for future research is to use appropriate tools for connecting bamboos so that their sturdiness is maximized. Laboratory equipment such as the UTM should be provided to update tensile strength data. It is also suggested that the hydroponic structure's ideal height should be at least 5 feet high (Reddy, 2018). It is also recommended to use a half-circle hook instead of an eye hook and tie a noose knot rather than a double overhand knot to assemble and disassemble the structure quickly. Replacing the PVC pipes with bamboo water pipes is also advisable. Designing an indoor tensegrity hydroponic system with LED grow lights and a water pump is recommended.

5. ACKNOWLEDGMENTS

The researchers thank our research mentor, Ms. Phebe Mendoza, for her continuous support and



encouragement in pursuing this research. All three of us sincerely appreciate the ideas, concepts, and opportunities shared in every discussion meeting with our mentor. Her participation is greatly acknowledged. To our research adviser, Ms. Leah Madrazo, we are grateful for the knowledge you have shared with us and for reminding us to work on our project while taking care of ourselves continuously.

Furthermore, the completion of this research would not have been possible without the support of our parents, Mr. and Mrs. Cabral, Mr. and Mrs. Magtibay, and Mr. and Mrs. Rosales. Thank you for allowing and accompanying us to do this research, despite the current situation. We could not thank you enough for the support and faith that you have put in us. We appreciate your support, either morally or financially.

Above all else, we thank God for providing us the wisdom and strength in completing this research.

6. REFERENCES

- Arjun, N. (n.d.). Tensegrity Structures-Benefits and Applications in Civil Engineering. The Constructor.
<https://theconstructor.org/structures/tensegrity-structures-benefits-applications/14181/>
- Bri. (2017, March 24). Health Benefits of Herbs and Spices. Nourished By Bri.
<https://www.nourishedbybri.com/post/2017/03/24/health-benefits-of-herbs-a-spices>
- Grady, A. (2020, March 20). Self-Sufficiency and Indoor Gardening. GroWell.
<https://www.growell.co.uk/advice/hints-tips/self-sufficiency-and-indoor-gardening>
- Hoover, C. (2018, October 4). Human-Centered Design vs. Design-Thinking: How They're Different and How to Use Them Together to Create Lasting Change. Moving Worlds.
<https://blog.movingworlds.org/human-centered-design-vs-design-thinking-how-theyre-different-and-how-to-use-them-together-to-create-lasting-change/>
- Love Nest Design. (2017, November 07). The Function of Aesthetics: Colour.
<http://lovenestdesign.ca/function-aesthetics-colour/>
- Modular Hydro. (n.d.). What Can You Grow Hydroponically?
<http://modularhydro.com/ArticleLibrary/WhatCanYouGrowHydroponically.html>
- Oxford Business Group. (2020, May 14). How state support and agritech solutions are enhancing the Philippines' food security during Covid-19.
<https://oxfordbusinessgroup.com/news/how-state-support-and-agritech-solutions-are-enhancing-philippines-food-security-during-covid>
- Reddy, J. (2018, June 18). Vertical Hydroponic Farming Systems Information. AgriFarming.
<https://www.agrifarming.in/vertical-hydroponic-farming-systems-information>
- Simscale. (n.d.). What is Von Mises Stress?
<https://www.simscale.com/docs/simwiki/fea-finite-element-analysis/what-is-von-mises-stress/>
- Sofa, A., & Sofa, A. (2020). Converting Home Spaces into Food Gardens at the Time of Covid19 Quarantine: all the Benefits of Plants in this Difficult and Unprecedented Period. *Human Ecology*, 48(2), 131-139.
<https://doi.org/10.1007/s10745-020-00147-3>



Efficiency of Renewable Energy for Reverse Osmosis Desalination Systems in Asian Developing Countries: A Systematic Review

Aimee Beatriz A. Acuña, Kim Ernest Joaquin B. Buluag, Rhod Symon P. Cadiente,
Beatrice Anne Q. Rigor and Joshua Emmanuel G. Tipon
De La Salle University Integrated School, Biñan City, Laguna

Abstract: Water shortage is an ongoing dilemma, especially in developing countries; hence, various desalination methods are constantly being created. This systematic review aims to assess the efficiency of utilizing renewable energy sources, in terms of operational costs, energy production, and gas emissions, for reverse osmosis desalination systems in developing Asian countries. By screening various texts from the database, ScienceDirect, the researchers found six studies that satisfied the selection criteria. The ROBINS-I tool and the GRADE assessment were used to ensure that the studies were valid for a systematic review. Photovoltaic (PV)-hybrid systems showed the best results in all three categories: operational costs, gas emissions, energy production. This study shows that renewable energy sources for desalination systems are suitable for the environment and found to be the most efficient in all three categories, as seen with PV systems.

Key Words: desalination; reverse osmosis; renewable energy; hybrid energy; developing countries

1. INTRODUCTION

The continuous reduction of freshwater sources is a “world crisis” (Li et al., 2016). It is even worse for developing countries that lack adequate water facilities, and sewage systems are discharged untreated, which leads to pollution in nearby bodies of water. There are already large-scale desalination and water treatment plants worldwide, with the largest ones in West Asia. Reverse Osmosis (RO) processes, which has a membrane-type desalination process that uses a semipermeable membrane to filter dissolved solids, are deemed relatively less harmful to the environment by producing fewer greenhouse gases and recovering more energy used (“What is reverse osmosis desalination?”, n.d.). Unfortunately, while RO systems create fewer greenhouse gasses than the other alternatives, desalination still emits a hefty amount of CO₂ into the atmosphere due to the utilization of diesel engines to power the plants. Some desalination plants remedy this by using renewable energy sources on their own or in conjunction with non-renewable energy to supply the energy needs of desalination plants. Renewable energy, or clean energy, is taken from natural sources, making them effectively infinite. This study aimed to assess the efficiency of renewable energy sources for reverse osmosis in terms of operational cost, energy production, and gas emissions. Specific energy sources for review are photovoltaic (PVT), wind, and hybrid technologies.

2. METHODOLOGY

The efficiency of the desalination systems in question was determined using three means: energy production (in kWh/year), operational cost (in USD), and gas emissions measured in the mass of CO₂ emitted per year.

2.1. Data Sources

To collect data, the researchers used the database ScienceDirect. The following keywords were sought:

("Reverse Osmosis" OR "RO") AND "Country" AND "Desalination"

The inclusion and exclusion criteria were based on an evidence-based model known as the PICO (Problem, Intervention, Comparison, Outcome) approach (“Guides: Evidence-Based Medicine Resource Guide: Clinical Questions, PICO, & Study Designs,” 2020). The researchers used studies from developing countries in Asia regarding Reverse Osmosis and compared the different energy sources used in reverse osmosis systems.

The PICO model used was comprised of:

P: Reverse Osmosis system

I: Renewable energy (PVT, Wind, and Hybrid)

C: Conventional energy (Diesel)

O: operational cost, energy production, and gas emissions

Inclusion Criteria:

- published texts from 2010 to 2020
- legally accessed research articles
- English
- experimental or case study design

2.2. Data Collection

The data collection process followed the 2009 Preferred Reporting Items for Systematic Reviews and Meta-Analyses (PRISMA) diagram (Figure 1) in selecting relevant articles for review (Moher et al., 2009). The screening of databases was performed following the selection criteria. The researchers then conducted a manual search of the remaining references by hand-searching and filtering texts according to their title and abstract. The remaining duplicates were also manually removed during this step. Further screening of the remaining papers included the search for the included parameters required for the study.

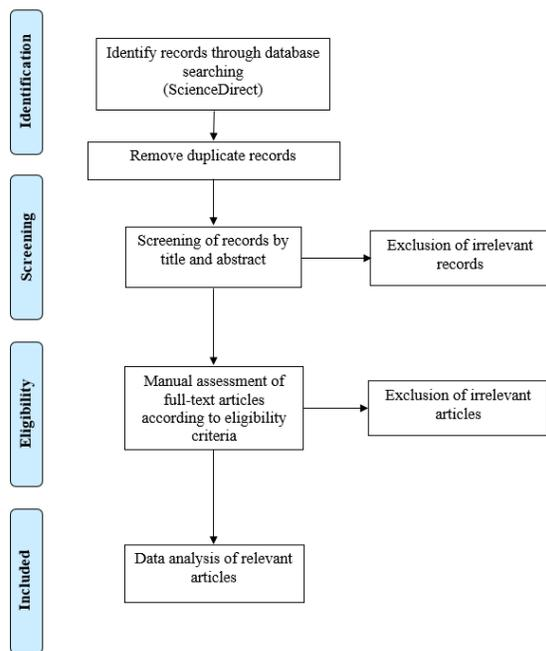

Figure 1. Initial PRISMA Flow Diagram to be utilized in the study

2.3 Risk of Bias Assessment

The risk of bias assessment followed the Risk Of Bias In Non-randomized Studies of Interventions (ROBINS-I) tool (Higgins, et al., 2020). This tool is recommended for assessing the risk of bias in non-randomized studies. Several reporting items were subjected to low, moderate, serious, and critical levels from having the lowest risk of bias to that of the highest. Each reporting item was presented with a signaling question that guided the researchers to

assess the indicating risk of bias for a particular aspect in the methodology.

2.4 GRADE Assessment

The data were analyzed and synthesized through the Grading of Recommendations, Assessment, Development and Evaluation (GRADE) approach used to determine the quality of evidence in a systematic review (GRADE Working Group, 2013). It is a transparent and structured process with specific definitions for each quality of evidence.

3. RESULTS AND DISCUSSION

3.1 Characteristics of Included Studies

According to the selection criteria, they were collated and characterized according to study methods, system description, interventions, and outcomes, as shown in Table 1. A total of 6 papers were selected for review.

Table 1 Summary table of the characteristics of individual studies

Study	Study Methods and Location	Energy Sources Used (Intervention)	Outcomes	Reference
Atallah et al. (2020)	Case series used HOMER software simulations Location: Nakhi city, Egypt	Diesel PV Wind Turbine Hybrid	Net present cost Monthly average electric production Carbon dioxide emissions Levelized cost of energy (COE)	Atallah, M. O., Farhat, M. A., Lotfy, M. E., & Senjyu, T. (2020). Operation of conventional and unconventional energy sources to drive a reverse osmosis desalination plant in Sinai Peninsula, Egypt. <i>Renewable Energy</i> , 145, 141-152. https://doi.org/10.1016/j.renene.2019.05.138
Gnaifaid & Ozcan (2020)	Experimental Location: Mersin, Turkey	Solar energy-driven trigeneration plant with thermal energy storage	RO Recovery ratio Solar Panel unit size effect on product cost ORC pressure ratio on electricity cost Ratio of Energy efficiency and cost Effect of global solar radiation on trigeneration costs Effect of RO recovery ratio on RO plant energy efficiency and freshwater cost at various seawater salinity	Gnaifaid, H., & Ozcan, H. (2020). Multi-objective optimization of a concentrated solar energy driven trigeneration plant with thermal energy storage: A case study for Turkey. <i>Case Studies in Thermal Engineering</i> , 20, 100642. https://doi.org/10.1016/j.csite.2020.100642
Gökçek (2018)	Case series Location: Niğde, Turkey	Diesel Wind PV Hybrid	Kgs of pollutant gases emitted per year Operational Cost	Gökçek, M. (2018). Integration of hybrid power (wind-photovoltaic-diesel-battery) and seawater reverse osmosis systems for small-scale desalination applications. <i>Desalination</i> , 435, 210-220. https://doi.org/10.1016/j.desal.2017.07.006
Ibrahim et al. (2020)	Case series HOMER software simulations Location: Ras El Bar City, Egypt	Diesel Wind Turbine PV Hydrokinetic Hybrid	Monthly average electricity production Levelized cost of electricity Levelized cost of water Pollutant emissions Net present cost	Ibrahim, M. M., Mostafa, N. H., Osman, A. H., & Hesham, A. (2020). Performance analysis of a stand-alone hybrid energy system for desalination unit in Egypt. <i>Energy Conversion and Management</i> , 215, 112941. https://doi.org/10.1016/j.enconman.2020.112941



Jones et al. (2016)	Case series Location: Jordan Valley, Jordan	PV	Net revenue (\$/ha/year) Annual water requirement (m ³ /ha/year) Area (ha) Water depth (m) Water salinity (ppm) Water temperature (°C)	Jones, M. A., Odeh, I., Haddad, M., Mohammad, A. H., & Qumr, J. C. (2016). Economic analysis of photovoltaic (PV) powered water pumping and desalination without energy storage for agriculture. Desalination, 387, 35-45. https://doi.org/10.1016/j.desal.2016.02.035
			Total capital cost (US\$) Annual operating cost (US\$) Overall water unit cost (US\$/m ³) Net present value Internal rate of return Return on investment	
Qiblawey, Banat, & Al-Nasser (2011)	Experimental Location: Hartha Charitable Society in the northern part of Jordan	PV	Percentage of recovery (%) Salt rejection percentage (%) Specific energy consumption (kWh/m ³) Permeate production (L/h) Total dissolved salts (30 mg/L) PV module efficiency (%)	Qiblawey, H., Banat, F., & Al-Nasser, Q. (2011). Performance of reverse osmosis pilot plant powered by Photovoltaic in Jordan. Renewable energy, 36(12), 3452-3460. https://doi.org/10.1016/j.renene.2011.05.026

3.2 Risk of Bias Assessments

The summary of all Risk of Bias assessments (Figure 2) indicates that approximately 33% of all chosen papers possessed a low risk of bias. Four papers have a moderate risk of bias. The moderate risk of bias was due to the modifications of initial interventions, which presented biases. This is conceivably due to the lack of representation in some data sets for selected articles, including those of Atallah et al. (2020), Ibrahim et al. (2020), and Qiblawey, Banat, & Al-Nasser (2011). Bias in the measurement of outcomes was also moderately prevalent because some interventions of renewable energy sources were presented using similar but different results, likely linked to the differing nature of each intervention.

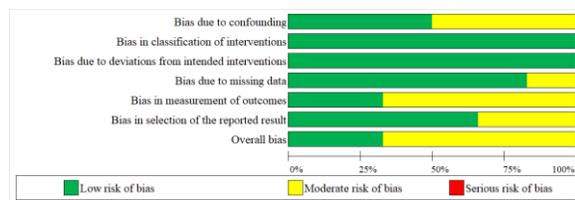

Figure 2 Percentage of responses in the risk of bias assessments for individual studies using the ROBINS-I tool

3.3 Quality of Evidence Assessments

For the quality of evidence assessment, the articles were graded according to the criteria specified in the previous chapter. Some items that may be seen in the paper potentially increased the quality of evidence, while some things decreased the quality of evidence in the paper. Table 2 shows the GRADE

assessments for each paper with the corresponding overall quality of evidence.

Table 2 Summary of GRADE assessments of individual studies

Study	Initial Quality of Evidence	Factors Increasing Quality of Evidence	Factors Decreasing Quality of Evidence	Overall Quality of Evidence
Atallah et al. (2020)	Low	Large magnitude of an effect (↑1 level) Effect of plausible residual confounding (↑1 level)	Inconsistency of results (↓1 level)	Moderate
Gnaifaid & Ozcan (2020)	Moderate	Large magnitude of an effect (↑1 level)	None	Moderate
Gökçek (2018)	Low	Large magnitude of an effect (↑1 level)	Limitations in study design or execution (risk of bias) (↓1 level)	Moderate
Ibrahim et al. (2020)	Low	Large magnitude of an effect (↑1 level) Effect of plausible residual confounding (↑1 level)	Inconsistency of results (↓1 level)	Moderate
Jones et al. (2016)	Moderate	Large magnitude of effect All plausible confounding would reduce the demonstrated effect or increase the effect if no effect was observed	Limitations in study design or execution (risk of bias) Inconsistency of results	Moderate
Qiblawey, Banat, & Al-Nasser (2011)	Moderate	Large magnitude of effect	Limitations in study design or execution (risk of bias)	Moderate

3.4 Discussion

3.4.1 Operational Costs

In terms of operational costs, the desalination system with the lowest costs would be a hybrid PV/diesel with a storage battery system. This trend can be seen in the studies of Atallah et al. (2020), Gökçek (2018), and Ibrahim et al. (2020). Atallah et al. (2020) didn't state the exact costs other than mentioning it having the lowest net present cost. For Gökçek (2018), the net current cost was said to be \$152,672. In the study of Ibrahim et al. (2020), their second option has photovoltaic/ hydrokinetic (PV-HKT) with a diesel generator as their optimal case; in fact, it showed lower costs than their first option's optimal case, which is the hybrid PV/Wind with a diesel generator. The second option showed a net present cost of 60,333 \$, while the first option had a net present cost of 119,260 \$. If implemented in the Philippines, it would be best to follow the trend of desalination systems in Asian developing countries and create a hybrid PV/diesel with a storage battery system.



3.4.2 Energy Production

In terms of energy production, the most efficient systems are hybrid PV/Diesel. Multiple cases are examined in related articles conducted by Atallah et al., Gökçek, and Ibrahim et al., concluding that PV systems out of all the other renewable energy sources, such as Wind turbines and diesel systems, perform more excellently for RO desalination systems. Considering that diesel and grid systems produce gas emissions while renewable energy sources such as PV arrays do not, the results presented by PV systems, despite their limited resources, are beyond compatible. Ranging from 8.3 kW to 32.7 kW to produce at maximum, 286,119 kWh per year breeds the best results for PV arrays connected to diesel systems. Diesel systems contribute to about 4.7% of the overall energy used. Based on the related literature, either a 19-string lead-acid battery or a wind turbine was used as the additional source of energy production for PV/Diesel hybrid systems that create the best performing hybrid approach in terms of energy production.

3.4.3 Gas Emissions

On the topic of gas emissions, the chosen studies generally saw similar results for similar cases. All desalination systems that make use only of renewable energy see zero emissions without exception. All the studies also come to similar conclusions in that sole diesel-powered desalination plants yield a significantly higher amount of greenhouse gas emissions than renewable energy and renewable-diesel hybrids. While their findings on hybrid energy systems differ, the studies still generally follow the same consensus in that hybrid systems, most notably those that employ HKT, significantly decrease carbon emissions than sole diesel systems with the PV-HKT-Diesel system emitting only 634 kg/year of CO₂.

4. CONCLUSION

The utilization of renewable energy for desalination systems should be encouraged because of its limited effect on the environment and as the most efficient means of creating energy for desalination systems regarding operational cost, gas emissions, and energy production. PV-Hybrid systems saw the most success in all categories in most of the studies. HKT-Hybrid designs, however, found the most success in all types except for energy production but only appeared in Ibrahim et al.'s study, making the results not as reliable nor conclusive as those for the PV-Hybrids. It is recommended that further research in the utilization of HKT hybrids for desalination plants be done. Future research is also essential to identify other factors that contribute to the implementation of

renewable energy for reverse osmosis plants, such as a specific country's geographic profile.

5. ACKNOWLEDGMENTS

We would like to thank Ms. Sherilyn Abarra and Ms. Leah Madrazo for their continuous guidance and support during the period of this review. Without their countenance, this study would not have come to fruition. We would also like to gratefully acknowledge De La Salle University for providing access to the resources needed and allowing us the opportunity to conduct this review, especially given the current circumstances of the pandemic.

6. REFERENCES

- Atallah, M. O., Farahat, M. A., Lotfy, M. E., & Senjyu, T. (2020). Operation of conventional and unconventional energy sources to drive a reverse osmosis desalination plant in Sinai Peninsula, Egypt. *Renewable Energy*, 145, 141-152. <https://doi.org/10.1016/j.renene.2019.05.138>
- Gnaifaid, H., & Ozcan, H. (2020). Multi-objective optimization of a concentrated solar energy driven trigeneration plant with thermal energy storage: A case study for Turkey. *Case Studies in Thermal Engineering*, 20, 100642. <https://doi.org/10.1016/j.csite.2020.100642>
- Gökçek, M. (2018). Integration of hybrid power (wind-photovoltaic-diesel-battery) and seawater reverse osmosis systems for small-scale desalination applications. *Desalination*, 435, 210-220. <https://doi.org/10.1016/j.desal.2017.07.006>
- GRADE Working Group. (2013). *GRADE handbook*. Retrieved from <https://gdt.grade.org/app/handbook/handbook.html#h.9rdbelsnu4iy>
- Guides: Evidence-Based Medicine Resource Guide: Clinical Questions, PICO, & Study Designs. (2020). Retrieved from <https://guides.dml.georgetown.edu/ebm/ebmclinic/alquestions>
- Higgins, J., Reeves, B., McAleenan, A., Sterne, J., & Hernan, M. (2020). *Cochrane Handbook for Systematic Reviews of Interventions* version 6.1 (updated September 2020). *Cochrane.org*. <https://training.cochrane.org/handbook/current/chapter-25>
- Ibrahim, M. M., Mostafa, N. H., Osman, A. H., & Hesham, A. (2020). Performance analysis of a stand-alone hybrid energy system for desalination unit in Egypt. *Energy Conversion and Management*, 215, 112941. <https://doi.org/10.1016/j.enconman.2020.112941>
- Jones, M. A., Odeh, I., Haddad, M., Mohammad, A. H., & Quinn, J. C. (2016). Economic analysis of photovoltaic (PV) powered water pumping and



desalination without energy storage for agriculture. *Desalination*, 387, 35-45.

<https://doi.org/10.1016/j.desal.2016.02.035>

Li, G.-X., Hou, P.-X., Zhao, S.-Y., Liu, C., Cheng., H.-M. (2016). A flexible cotton-derived carbon sponge for high-performance capacitive deionization. *Carbon*.

<https://doi.org/10.1016/j.carbon.2015.12.095>

Moher D., Liberati A., Tetzlaff J., Altman D.G., The PRISMA Group (2009). Preferred Reporting Items for Systematic Reviews and Meta-Analyses: The PRISMA Statement. *PLoS Med* 6(7): e1000097.

<https://doi.org/10.1371/journal.pmed1000097>

What is reverse osmosis desalination?. Retrieved from <https://www.activesustainability.com/water/what-is-reverse-osmosis-desalination/>

Qiblawey, H., Banat, F., & Al-Nasser, Q. (2011). Performance of reverse osmosis pilot plant powered by Photovoltaic in Jordan. *Renewable energy*, 36(12), 3452-3460.

<https://doi.org/10.1016/j.renene.2011.05.026>



The Effect of Mango Peel on the Growth of Okra (*Abelmoschus esculentus*)

Krista D. Belmonte, Rachel Ashley A. Calpo, Aris Mateo T. Filipino
and Edrante Thaddeus S. Montales
De La Salle University Integrated School, Biñan City, Laguna

Abstract: Fertilizers are substances containing nitrogen, phosphorus, and potassium. They supply nutrients to the soil to improve plant growth and plant productivity. While they may have helped the agriculture sector better their crops, recent studies suggest that common fertilizers adversely affect the environment and human health. Aside from common fertilizers, fruit peels, such as mango peels, also pollute the environment since their accumulation leads to waste disposal issues. To alleviate these issues, researchers proposed the utilization of fruit peels as fertilizers. In this study, mango peels were utilized as fertilizers to identify their effects on the growth of the okra plants by measuring the plant height and comparing the number of leaves. Five (5) pots with two okra seeds were assigned specified amounts of mango peels: 0 g, 1 g, 3 g, 5 g, and 7 g. Plant height and number of leaves were measured every two weeks for two months. The results suggest that varying amounts of applied mango peels affect the growth rate of okra, with 7 g yielding both the highest plant height and highest number of leaves. The results can be attributed to the nutrients of the mango peels, such as potassium and phosphorus, which are included in the three primary nutrients found in common fertilizers.

Key Words: mango peels; okra; fertilizer; plant height; number of leaves

1. INTRODUCTION

Fertilizers are organic or chemical products that supply the soil nutrients, primarily nitrogen, phosphorus, and potassium, to improve plant growth and plant productivity (Morari et al., 2011; Jariwala & Syed, 2016). For some time, organic fertilizers have been the primary source of nutrients for plants since these have helped the agriculture sector improve their soil and crop growth (Morari et al., 2011).

Despite its benefits for soil management and plant growth, studies have found significant adverse effects on the environment and human health, ranging from water or air pollution, crop contamination to food borne illnesses (Morari et al., 2011). In response, researchers have sought alternative sources of nutrients aside from the common fertilizers, one of them being the utilization of agro-wastes, such as fruit peels. Previous studies by Halpatrao et al. (2019) and Jariwala and Syed (2016) confirmed that fruit peel fertilizers are suitable as soil fertilizers after analyzing the peels' pH level and nutrients.

However, there is still a lack of study regarding the utilization of mango agro-waste as fertilizers. Mangoes are among the most globally advertised fruits, with their global production increasing to 50.65 million metric tons of mangoes in 2017 (Statista, 2020). Their wastes were found to be

abundant in potassium, phosphorus, and calcium, with the first two being part of the three primary nutrients found in common fertilizers, implying the mango peels could potentially be utilized as fertilizers (Nijiru et al., 2014; The Fertilizer Institute, 2016).

This study focused on utilizing mango peels as fertilizer and an alternative to common fertilizers by determining whether it is effective on okra. Okra plants were used since they grow and germinate fast, making them suitable for observing the effects of fertilizer for a short time. Okra takes 6 to 18 days to germinate and 2 to 3 months for it to mature (Luttjohann, 2017; Masabini, n.d.; Seed Savers Exchange, n.d.). During the experiment, medium-sized chopped carabao mango peels were used and introduced onto the soil of the okra plants in specified amounts for each pot. The plant height and number of leaves of the plants were measured and counted, respectively, then evaluated whether varying amounts of mango peels affect the growth of the okra plants. The effects of mango peels and common fertilizers were not compared.

2. METHODOLOGY

2.1 Materials

The variant of mango used for the study was the Philippine mango, otherwise known as the



Carabao mango since it is the most produced mango variant in the Philippines (Philippine Statistics Authority, 2021). Next, the five pots used were approximately 12” in height and 12” in diameter. Okra (*Abelmoschus esculentus*) seeds were also used since okra can grow in season all year round (Bureau of Plant Industry, 2020).

2.2 Mango Peel Application

Two researchers were assigned to the experiment. Each researcher gathered all the needed materials for the first week: Five pots, okra seeds, and mango peels. Once the materials were complete, two okra seeds were planted in each pot. These seeds were given one to two weeks to germinate before proceeding to the mango peel application.

The researchers were assigned to plant two okra seeds and apply 0 g, 1 g, 3 g, 5 g, and 7 g of mango peels in each pot. The pots were labeled as follows in Table 1. The MPs in the code stand for mango peels, while the numbers stand for the number of mango peels applied in grams.

Table 1. Labels for the number of mango peels applied to each pot

Code	Amount of Mango Peels (g)
MP0	0
MP1	1
MP3	3
MP5	5
MP7	7

After the plant germinated, the mango peels were placed onto the soil of each plant according to the amount designated per pot every two weeks until the last data collection. The plant height was measured and recorded in centimeters to observe plant growth. Aside from plant height, the number of leaves attached to the plant was also recorded. The researchers also met every two weeks for two months to discuss and gather all the collected data until the last week of observation. Then, the data were analyzed and compared using various analysis strategies.

2.3 Research Design

An experimental type of research was conducted, which allowed the researchers to observe the effect of varying amounts of mango peels on the plant. The setup consisted of five pots, with each having two seeds of okra plants. Each pot was labeled as follows: MP0, MP1, MP3, MP5, and MP7. Furthermore, the researchers had 14 weeks to conduct the experiment, observe the plants, and collect

primary data centered on plant height changes and the number of leaves. After gathering the data every two weeks for two months, the researchers set meetings to analyze the data that they have collected.

2.4 Data Analysis Strategy

First, the researchers observed the effects of the mango peels on plant growth by analyzing and comparing the plant height and number of leaves data per pot. The collected data from the experiment was organized and kept on a log to ensure ease in data classification and data analysis. The plant’s growth was presented on a bar graph to show the differences between the height of the plants each time it was recorded every two weeks for two months. Lastly, error bars were used to identify the uncertainties and the variability of the data gathered.

3. RESULTS AND DISCUSSION

3.1 Number of Leaves

The number of leaves that were attached to the plant was counted, while those that were unhealthy or wilted but attached were not. The following bar graph shows the recorded average number of leaves per gram from January and March.

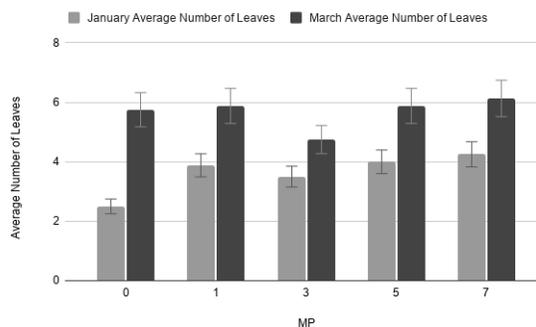

Figure 1 Average Number of Leaves Per MP

MP7 had the highest average number of leaves for both January and March, which is consistent with the study by Wazir et al. (2018), in which they observed from their research that the fruit peel fertilizer yielded the most significant number of pea leaves, with a mean average of 79.00, as compared to the controlled setup, which had a mean average of 55.00. On the other hand, MP3 yielded the lowest for January while MP3 for March. The results may be associated with the phosphorus and potassium content of mango peels. Both enhance plant growth by improving the photosynthesis rate through an increased adenosine triphosphate production in the plants (Conway et al., 2003; Kirschbaum, 2010; Kaisler & Rosen, 2021). According to the findings of Xu et al. (2020), using fertilizers with high



concentrations of nitrogen, phosphorus, and potassium yields the highest number of leaves per plant as compared to the other fertilizer treatment. This would explain why the setups with the least amount of mango peels applied yielded the least number of leaves since they had less to no added nutrients from the fertilizer to absorb and promote their plant growth. Aside from that, the aphid infestation during the first data gathering in March may have also contributed to the significantly low yield of MP3 in the same month. According to Sorensen (2009), aphids can hinder nutrient absorption by feeding on plant sap.

3.2 Plant height

The plant height measurement was used as an indicator of its growth rate. The recorded plant height from each MPs from both the researchers was averaged and plotted into a bar graph to observe the effect of different mango peel concentrations on the growth rate of the okra plants. Below is the bar graph for the average okra plant height with varying amounts of mango peel applied.

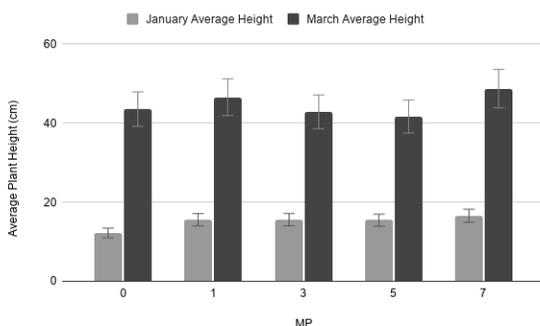

Figure 2. Average Plant Height Per MP

For both January and March, MP7 had the highest average height while MP0, the controlled variable, had the lowest for January and MP5 for March. For MP5, its short average plant height may have been caused by the aphid infestation that affected one of the MP3 and MP5 setups during the first data gathering in March. According to Sorensen (2009), aphids can remove plant nutrients, which may have caused a decrease in the growth rate of MP5. On the other hand, the high potassium and phosphorus content in mango peels may have contributed to the highest average height of MP7 for January and March (Nijiru et al., 2014; The Fertilizer Institute, 2016). Both potassium and phosphorus enhance the rate of photosynthesis by increasing the production of adenosine triphosphate within the plants, consequently improving their growth rate (Conway et al., 2003; Kirschbaum, 2010; Kaisler & Rosen, 2021).

In addition, the results are also consistent with the findings of Mercy et al. (2014), in which the plant height of the fenugreek with fruit peel power applied to the soil was higher than the one without. Furthermore, Halpatrao et al. (2019) also support the result, as they have found that fruit peels increase the plant height and shoot length of the monggo plant.

4. CONCLUSIONS

The study results showed that varying amounts of mango peels affect the growth of the okra and that mango peels can be an effective alternative to common fertilizers for okra plants. In terms of the best amount of mango peel fertilizers to apply, the results suggest that MP7 is the most effective for the growth of the okra, seeing that MP7 was the only setup to yield the highest plant height and number of leaves consistently. The results can be attributed to the nutrients of the mango peels, such as the presence of potassium and phosphorus, which are included in the three primary nutrients of common fertilizers (Nijiru et al., 2014; The Fertilizer Institute, 2016). On the other hand, MP3 was with the lowest plant height and number of leaves, primarily due to the aphids damaging the plants and disrupting nutrient absorption.

Future researchers are recommended to analyze the leaf areas and to test the mango peel fertilizers on other plants for further studies. Additionally, it is also recommended in one specific location so that the results would be precise.

5. ACKNOWLEDGMENTS

The group would like to thank Dr. Kerry Cabral as the research adviser and mentor throughout the study and the writing of the research paper.

6. REFERENCES

- Conway, W. S., Faust, M., & Sams, C. E. (2003). Fruits of Temperate Climates | Factors Affecting Quality. *Encyclopedia of Food Sciences and Nutrition*, 2768–2774. <https://doi.org/10.1016/b0-12-227055-x/00532-0>
- Halpatrao, A., Sonawane, A., Chavan, A., Mansoori, I., Kasurde, N., Kondkar, N., Sayyad, R., & Durve-Gupta, A. (2019). Application of Different Fruit Peels Formulations as a Natural Fertilizer for Plant Growth. *Journal of Emerging Technologies and Innovative Research*, 6(5), 152–157. <http://www.jetir.org/papers/JETIRCB06023.pdf>
- Jariwala, H. J., & Syed, H. S. (2016, November). Study on Use of Fruit Peels Powder as a Fertilizer. *Recent Advances in Environmental Sciences and Engineering*. <https://www.researchgate.net/publication/319329>



- 572_Study_on_Use_of_Fruit_Peels_Powder_as_a_Fertilizer
- Kaisler, D. E., & Rosen, C. J. (2021). Potassium for crop production. Crop Production. University of Minnesota Extension.
- Kirschbaum, M. U. F. (2010). Does Enhanced Photosynthesis Enhance Growth? Lessons Learned from CO₂ Enrichment Studies. *Plant Physiology*, 155(1), 117–124. <https://doi.org/10.1104/pp.110.166819>
- Luttjohann, B. (2017, January 24). Okra: The Permaculture Research Institute. <https://www.permaculturenews.org/2017/01/24/okra/>
- Philippine Statistics Authority. (2021). Major Fruit Crops Quarterly Bulletin, October-December 2020 (pp. 1–17). Philippine Statistics Authority.
- Bureau of Plant Industry. (2020, August 10). Planting Calendar. Bureau of Plant Industry; Department of Agriculture. <http://bpi.da.gov.ph/bpi/index.php/news/8536-planting-calendar-here-s-your-easy-guide-on-when-is-the-best-time-of-the-year-to-plant-your-vegetables-their-maturity-estimated-harvest-per-ha-and-distance-of-planting>
- Masabini, J. (n.d.). Okra - How long does it take to grow and harvest okra? Texas A&M AgriLife Extension Service. <https://agrilifeextension.tamu.edu/library/gardening/okra/>
- Morari, F., Vellidis, G., & Gay, P. (2011). Fertilizers. *Encyclopedia of Environmental Health*, 727–737. <https://doi.org/10.1016/b978-0-444-52272-6.00464-5>
- Nijiru, M. K., Nawiri, P. M., Wanjau, R., & Odundo, J. O. (2014). Residues of *Mangifera indica* L. as alternative animal feed in Embu county, Kenya. *Green Chem*, 16, 1–10. https://www.researchgate.net/profile/Joseph_O_Odundo/publication/262796847_Residues_of_mangifera_indica_L_as_alternative_animal_feed_in_Embu_county_Kenya/links/02e7e538de7662d7f8000000.pdf
- Seed Savers Exchange. (n.d.). Grow Okra - Seed Savers Exchange. Seed Savers Exchange. <https://www.seedsavers.org/grow-okra>
- Sorensen, J. T. (2009). Aphids. *Encyclopedia of Insects*, 27-31. doi:10.1016/b978-0-12-374144-8.00008-4
- Statista. (2020). Mango production worldwide 2017. Statista. <https://www.statista.com/statistics/577951/world-mango-production/#:~:text=Global%20mango%20production%202000%2D2017&text=The%20global%20production%20volume%20of>
- The Fertilizer Institute. (2016, October 31). Fertilizer 101: The Big 3 - Nitrogen, Phosphorus and Potassium. The Fertilizer Institute. <https://www.tfi.org/the-feed/fertilizer-101-big-3-nitrogen-phosphorus-and-potassium>
- Wazir, A., Gul, Z., & Hussain, M. (2018). Comparative Study of Various Organic Fertilizers Effect on Growth and Yield of Two Economically Important Crops, Potato and Pea. *Agricultural Sciences*, 09(06), 703–717. <https://doi.org/10.4236/as.2018.96049>
- Xu, F., Chu, C., & Xu, Z. (2020). Effects of different fertilizer formulas on the growth of loquat rootstocks and stem lignification. *Scientific Reports*, 10(1), 1–11. <https://doi.org/10.1038/s41598-019-57270-5>



The Design Development of Solar Box Cooker on Wheels as an Alternative for Philippine Rural Households

Pamela L. Dator, Alexandra D. Fabro, Bealinn M. Maglanque
and Amelle R. Reyes

De La Salle University Integrated School, Biñan City, Laguna

Abstract: Cooking accounts for a significant share of the worldwide energy consumption issue. Solar box cookers are a good alternative in mitigating fossil fuels and biomass use, especially for tropical developing nations like the Philippines. Still, their broad acceptance is limited by their high dependence on sufficient sunlight for better performance. Thus, this research aims to develop a thermal-efficient, portable solar box cooker with sand-sensible heat storage materials, coconut coir (*Cocos nucifera*) agricultural waste insulators, and locally sourced building materials. The designed and constructed cooker was evaluated using three thermal performance tests: the Stagnation Temperature test from the Bureau of Indian Standards (BIS), the Cooking Power test from the American Societal of Agricultural Engineer (ASAE) Standards, and a rice cooking test. Data obtained from the three-day trials of each test were used to determine the first figure of merit (F_1), the single measure of performance ($Ps(50)$), and its ability to cook 300 g of NFA rice with 500 mL of water, respectively. It was found that the cooker achieved an F_1 of 0.06 Km^2/w , a $Ps(50)$ of 6.651 W, and cooked rice for one-third of the tests. Obtained experimental findings showed that the device is marked as a Grade-B solar cooker. Results indicated that the solar box cooker is capable of pasteurizing water and cooking rice.

Key Words: solar box cooker; thermal performance; stagnation temperature; cooking power; rice cooking ability

1. INTRODUCTION

With the increase of the human population and industrial developments, energy demand increases due to the high consumption for human endeavors. An essential energy activity in domestic sectors that accounts for 50% of energy consumption is cooking (Aadiwal et al., 2017). This activity makes fossil fuels, such as charcoal, wood, and natural gas, the most dominant energy source broadly used in many households. (World Health Organization, 2016). According to Das et al. (2017), one of the most prominent biomass consumers, including charcoal and fuelwood, in developing countries is rural households. Despite its cost-effectiveness, these energy sources pose higher pollutant emissions and health problems (Yamamoto et al., 2013); thus, necessitating developing alternative, sustainable, and economically feasible cooking methods.

The sun's solar radiation acts as an efficient and eco-friendly energy source for cooking, given it is clean, renewable, abundant in nature, and accessible in various tropical regions worldwide. The Philippines, a tropical country that receives 4.87 kWh/m^2 , holds a potential beneficiary for solar technology (Malicdem, 2015). Solar cookers harness solar energy to convert it into heat for cooking food

and pasteurizing water. Among the different solar cookers, a Solar Box Cooker (SBC) is the most suitable type for developing countries, given its simple and durable design, low-cost materials, minor interference, and risk-free features (Kimambo, 2007; Aadiwal, 2017). It takes advantage of direct and diffuse solar radiation in generating heat as the glazing cover traps it inside the cooking chamber.

Despite its ideal structure, it exhibits drawbacks in thermal performance due to its slow cooking process. With the sun's intermittent nature, the device's dependence on consistent solar energy hinders its pervasive use and immense potential. Researchers attempted to resolve this by altering solar box cookers' components to examine whether it could further improve its thermal performance.

Aremu and Akinoso (2013) tested five different solar box cookers. They concluded the cooker insulated with coconut coir (*Cocos nucifera*) was the best performing, for it yielded satisfactory results in stagnation temperature and thermal efficiency (Aremu & Akinoso, 2013). As for sensible heat storage material (SHS), Francis et al. (2016) advised using sand for a higher energy-storing efficiency of 4.145% compared to water. The Philippines produces a considerable number of agricultural wastes, including

coconut coir (*Cocos nucifera*), and uses sand for multiple construction purposes. This study used locally available insulation, sensible heat storage, and construction materials to develop a thermal-efficient solar box cooker as an alternative cooker for Filipino rural households.

The specific objectives of the study are the following:

1. Design and construct a portable solar box cooker with Vibro sand SHS material, coconut coir (*Cocos nucifera*) insulator, and readily available materials in the Philippines; and
2. Evaluate the solar box cooker's thermal performance using three thermal performance tests: the Stagnation Temperature test, Cooking Power test, and a rice cooking test.

2. METHODOLOGY

A quantitative research method was adopted to evaluate the designed solar box cooker's thermal performance fabricated using local materials, Vibro sand sensible heat storage material (SHS), and coconut coir (*Cocos nucifera*) insulator. The methodology was divided into three phases: the design and construction phase, the performance testing phase, and the performance evaluation phase.

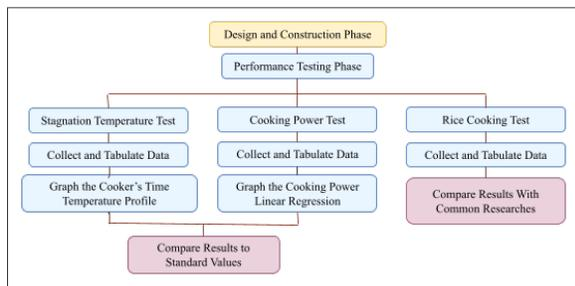

Figure 1 Methodology Flow Diagram

2.1 Design and Construction of the Solar Box Cooker

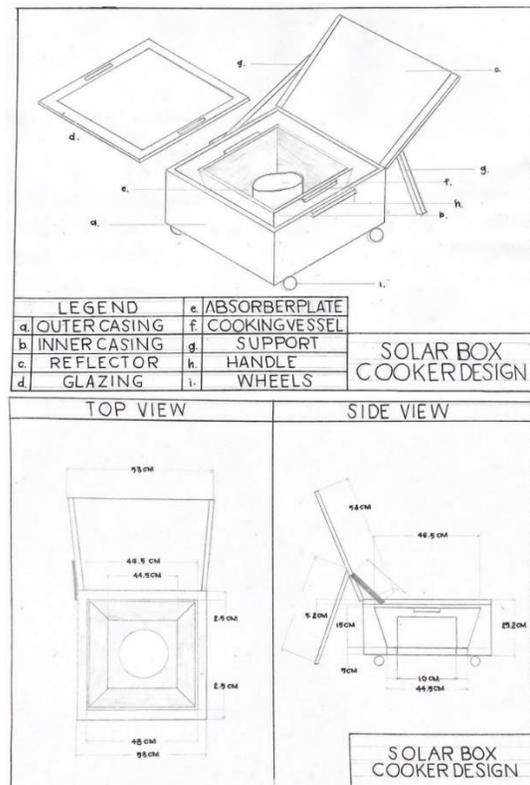

Figure 2 Schematic Diagram of the Solar Box Cooker

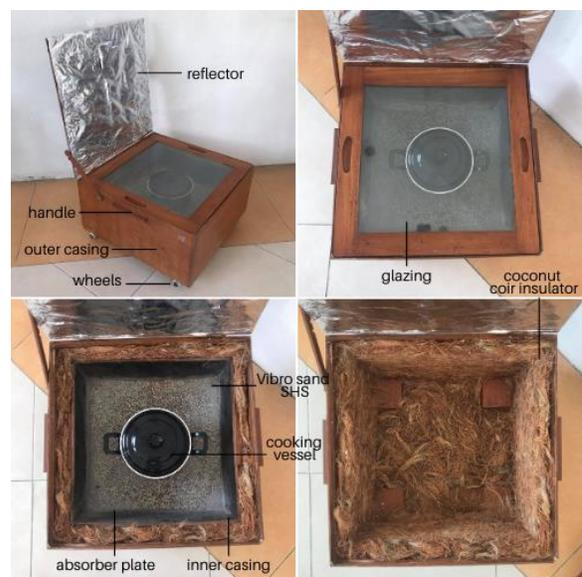

Figure 3 Constructed Solar Box Cooker

The solar box cooker consists of the following components: a plywood outer casing, plywood inner

casing lined with a black absorber plate made of Minola cooking oil tin can, aluminum foil reflector, windowpane glass as double glazing, black aluminum cooking pot, Vibro sand SHS material, and coconut coir (*Cocos nucifera*) insulator. Handles and wheels were also added for easy transportation and consumer use.

The prototype's components, materials, and design specifications were decided upon by reviewing the availability, efficiency, and cost of the materials and previous researchers' recommendations. The works of Weldu et al. (2019), Ademe and Hameer (2017), Yusuf et al. (2014), and Folaranmi (2013) were used as a reference, as they studied the features that facilitate increasing the efficiency of solar box cookers. No patent infringement is susceptible in the process of replicating specific details in their SBC design. An ethical acknowledgment of the ideas and works borrowed was given through proper citation.

2.2 Thermal Performance Testing and Evaluation

The solar box cooker's thermal efficiency was examined by conducting the Stagnation Temperature test from the Bureau of Indian Standards (BIS), the Cooking Power test from the American Societal of Agricultural Engineer (ASAE) standards, and a rice cooking test. These three tests were performed to determine the first figure of merit (F_1), the standardized cooking power (P_{50}), and the cooking time, respectively. Three-day trials were carried out for each performance test, and the mean data acquired were evaluated using criteria values. A digital anemometer, kitchen scale, solar power meter, and type K thermocouple wire and sensor were utilized.



Figure 4 Stagnation Temperature Test Experimental Set-up

The Stagnation Temperature test presented and monitored the unloaded solar box cooker's time and temperature profile under the sun to determine the maximum attainable absorber plate temperature

(Aremu & Akinoso, 2013; Ademe & Hameer, 2018). The cooker was placed under the sun 30 minutes before the data collection to simulate cooking procedures when using the device and gauge how high the plate temperature could reach, supposing that it is preheated by consumers 30 minutes before cooking. The plate temperature ($^{\circ}\text{C}$), ambient temperature ($^{\circ}\text{C}$), solar insolation (W/m^2), and wind speed (m/s) were measured at every five-minute interval from 10:00 until it reached its quasi-steady state, which is identified using a given set of conditions. It is used to compute the performance index, the first figure of merit (F_1), which depicts the cooker's ability to develop and retain maximum temperature (Kundapur & Sudhir, 2009). An F_1 equal to or greater than 0.12 marks the device as a Grade A solar cooker, while less than 0.12 marks it as a Grade B solar cooker.



Figure 5 Cooking Power Test Experimental Set-up

Cooking Power is defined as the rate of useful energy available during heating (Folaranmi, 2013; Ademe & Hameer, 2018). Linear regression analysis was used to determine the relationship between cooking power and temperature difference regarding intercepts and slopes using the standardized cooking power and temperature difference as the Y and X-axis (Weldu et al., 2019; Aremu & Akinoso, 2013). The water temperature ($^{\circ}\text{C}$), ambient temperature ($^{\circ}\text{C}$), solar insolation (W/m^2), wind speed (m/s) were recorded for every ten-minute interval to compute the two plots. The cooking power curve served as a tool in indicating the two essential performance parameters, mainly the cooker's capacity and heat retention abilities (Funk, 2000). In terms of prototype evaluation, the resulting coefficient of determination (R^2) must exceed 0.75. The single measure of performance (P_{50}) of the cooking power regression equation was another evaluation measure for the designed solar box cooker's performance that served as a unit for comparison.



Figure 6 Rice Cooking Test Experimental Set-up

The rice cooking test determined the device's thermal performance in terms of its rice cooking ability. The unloaded SBC was preheated under the sun at 8:30 to build up heat for 30 minutes. The cooking pot filled with 300 g NFA rice and 500 mL water was then placed on the absorber plate at 9:00. The pot's temperature (°C) and corresponding ambient temperature (°C), solar insolation (W/m²), and wind speed (m/s) were measured at every 15-minute interval. The cooking time was recorded once the rice is cooked, characterized by a firm texture and sticky consistency. The data were compared with other researchers to determine if sensible and realistic results were achieved. A cooking time of 120 to 180 minutes is manifested to be the ideal duration for a 300 g load of rice from the studies of Rikoto and Garba (2013) and Aremu et al. (2019).

3. RESULTS AND DISCUSSION

3.1 Stagnation Temperature

The Stagnation Temperature test was carried out for three consecutive days from February 15 to 17, 2021. To identify the stagnation temperature needed for F₁ evaluation as set by the BIS (2000), variations of ±1°C for plate temperature, ±20 W/m² for solar radiation >600 W/m², and ±0.2°C for ambient temperature must be complied with.

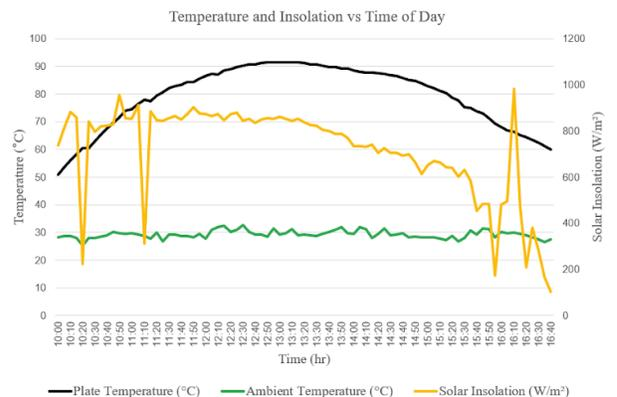
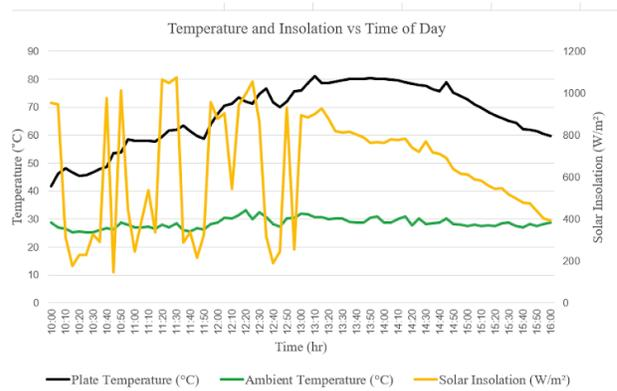
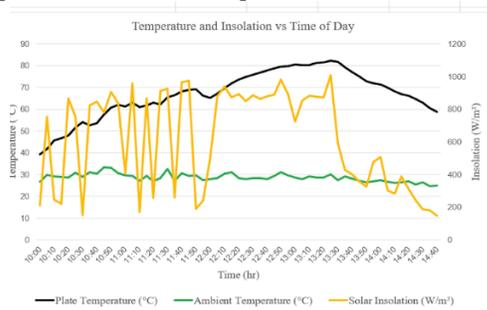

Figure 7 From Top to Bottom: Temperature Variation Curve During Stagnation Temperature Test Days 1 to 3

Table 1 Summary of Data from Days 1 to 3 of the Stagnation Temperature Test

	Day 1	Day 2	Day 3
Highest Plate Temperature (°C)	82.3	80.3	91.5
Mean Ambient Temperature (°C)	29.3	28.5	29.2
Mean Solar Insolation (W/m²)	716	644	824
Mean Wind Speed (m/s)	1.1	1.0	1.0
F₁ (Km²/w)	0.05	0.07	0.07

As shown in Figure 7, frequent cloud coverage during the first and second days led to the sharp alternating of high and low solar insolation outputs during the first two hours of the experiment. The highest plate temperature among the three trials was achieved during the third day due to relatively good radiation. The data obtained were insufficient to determine the optimal stagnation plate temperature due to high variations in ambient temperatures exceeding the ±0.2°C condition during the three-day trials.



The mean first figure of merit (F_1) achieved by the cooker is found to be $0.06 \text{ Km}^2/\text{w}$, which is 50% of the BIS (2000) expected value of $0.12 \text{ Km}^2/\text{w}$. Thus, the designed SBC is classified as a Grade B solar cooker. The cooker's F_1 value is lower than the values obtained by the SBCs of Folaranmi (2013), Weldu et al. (2019), and Aremu et al. (2019), who obtained figures of 0.11, 0.154, and a range of 0.9 to $0.13 \text{ Km}^2/\text{w}$, respectively. Despite this, the cooker reached plate temperatures above 90°C and sustained a temperature above 75°C for 265 minutes.

3.2 Cooking Power

The Cooking Power test was conducted on March 2, 3, and 5, 2021. The 2.310 kg water load was derived from the ASAE S580 (2013) standard of multiplying 7 kg by the cooker's intercept area. The standard cooking power (P_s) was plotted against the temperature differences (T_d), as shown in Figure 7. Data with wind speeds above 2.5 m/s were excluded to from meeting the ASAE S580 (2013) conditions on uncontrolled weather variables. Outliers caused by sudden cloud covers were also removed to allow statistically relevant results.

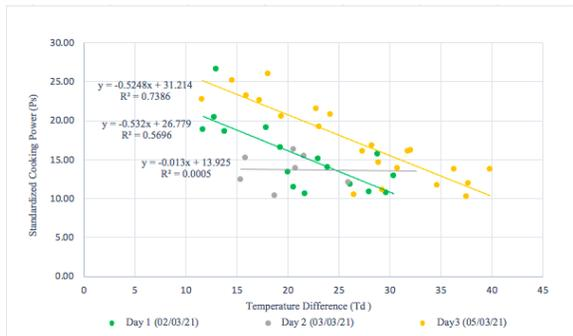

Figure 8 Standard Cooking Power Plotted Over Temperature Difference

Table 2 Summary of Data from Days 1 to 3 of the Cooking Power Test

		Day 1	Day 2	Day 3
Cooking Regression Equations	Intercepts (W)	26.78	13.93	31.21
	Slope ($\text{W}/^\circ\text{C}$)	-0.53	-0.013	-0.52
Coefficient of Determination (R^2)		0.57	0.0005	0.74
Mean Ambient Temperature ($^\circ\text{C}$)		34.5	30.3	30.2
Mean Solar Insolation (W/m^2)		770	573	813
Mean Wind Speed (m/s)		0.9	1.5	1.5

The initial standardized cooking power for the first, second, and third days are 26.78, 13.93, and 31.31 W, respectively, exhibiting the expected linear decrease as the cooking power begins at a high value and lowers as the temperature difference increases. Although the second day had sudden cloud covers that influenced the low average insolation record, the power regression equation showed a negative slope of $-0.013 \text{ W}/^\circ\text{C}$, which complimented the cooker's heat retention capabilities. The first and third trials exhibited an ideal power curve. The first day had cloudy conditions that caused outliers. In contrast, the third day had high average insolation owing to very minimal cloud coverage, presenting the optimal performance of the cooker in heating food and sustaining heat.

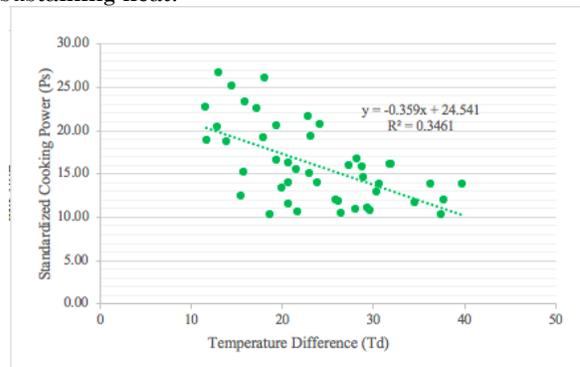

Figure 9 Overall Cooking Power Performance

The cooking regression equation is $P_s = 24.541 - 0.359 T_d$. The standardized cooking power at 50°C temperature difference (P_{50}) was determined as 6.651 W using the equation, which is lower compared to the results of Folaranmi (2013), Aremu and Akinoso (2013), and Weldu et al. (2019), as their figures are 23.95, 37.20, and 39.54 W, respectively. The coefficient of determination (R^2) obtained was 0.35, which does not satisfy the standard value of the ASAE S580 (2013). This indicates that only 35% of the standardized cooking power's variation can be attributed to the temperature difference. The resulting values are due to low insolation caused by sudden cloud formations and the sun's intermittence every ten minutes during the first and second days.



3.3 Rice Cooking

Figure 10 From Left to Right: Resulting Rice Load of Rice Cooking Test Days 1 to 3



Table 3 Summary of Data from Days 1 to 3 of the Rice Cooking Test

	Day 1	Day 2	Day 3
Highest Pot Temperature (°C)	71.1	78.5	83.3
Mean Ambient Temperature (°C)	30.1	31.4	31.6
Mean Solar Insolation (W/m²)	467	730	723
Mean Wind Speed (m/s)	0.3	1.0	0.7
End of Recording	14:00	14:30	16:00

The rice cooking test was conducted from March 17 to 19, 2021. On the first day, the rice still had water and a hard and grainy texture, indicating that it was uncooked. Compared to the subsequent trials, the first day had the least sunlight availability. On the second day, the rice's top layer had a sticky texture with no water, while the bottom had a hard and grainy texture, indicating that it was partially cooked. As shown in Table 3, there was higher sunlight availability, increasing the water absorption compared to the first day. On the third day, the rice was firm, tender, and had a sticky texture, indicating that it was cooked. There were favorable weather conditions similar to the second day. Consequently, the cooking time was 420 minutes, which is slower than the results of Rikoto and Garba (2013) and Aremu et al. (2019). The frequent opening of the glazing and pot could have contributed to the obtained time.

4. CONCLUSION AND RECOMMENDATIONS

This study's overall objective seeks to manufacture a design equipped with readily available sensible heat storage material (SHS) and an insulator to improve solar box cookers' thermal efficiency for rural households in the Philippines. Despite the three performance tests' experimental results showing the

cooker's underperformance in fluctuating weather conditions, it highlights satisfactory results in sustaining heat inside the cooking chamber. The cooker's performance under unremitting solar radiation showed its ability to pasteurize water and cook rice.

Future research should center on developing designs that optimize available materials and solar radiation to improve an SBC's heat accumulation further. A comparative analysis of varying cooker configurations in different sites should also determine the most suitable design for a specific region in the Philippines.

5. ACKNOWLEDGMENTS

We acknowledge the support provided by the De La Salle University Integrated School towards this study with gratitude. The institution also aided in funding the expenses of this experimental research. We would like to thank our parents for their all-round support and understanding to accomplish this research. It is also worth mentioning the people who have taken part in the accomplishment of this research manuscript. This includes Sr. Pyker Lemi Picart Jr., who gave his suggestions during the research topic's planning and development. The group would not have been able to conceptualize a timely and relevant topic without his idea. We give special thanks to Ms. Mary Geraldine C. Yumang, our research adviser, for her constant guidance and encouragement, which significantly contributed to completing this research. She gave us a significant amount of her time and effort to assist us throughout the process. Ms. Leah D. Madrazo, our research mentor, has also provided support and teachings that have been applied in the manuscript. We also extend our gratitude to our international research mentors Dr. Paul Funk and Professor Mulu Bayray Kahsay, who have aided us by sharing their knowledge on this topic. Their patience in answering our queries through Emails despite the time difference has genuinely helped and guided us in producing a well-accomplished study. We would also like to thank Ms. Whenn Peña, the STEM coordinator, and Ms. Myrla Torres for allowing us to conduct this experimental research despite the pandemic and for taking the time and effort to evaluate and share their opinions to improve the topic and scope of our study. The completion of the thermal performance tests is also attributed to Engr. Cesnar Contado, who has helped acquire equipment by lending the solar power meter for this study. We would also like to thank and give credit to the Angeles Wood Works to construct the solar box cooker. Most importantly, we thank God for giving us the strength and guidance to accomplish this research.



6. REFERENCES

- Aadiwal, R., Hassani, M., & Kumar, P. (2017). An overview study of solar cookers. *International Research Journal of Engineering and Technology*, 4(10). <https://www.irjet.net/archives/V4/i10/IRJET-V4I10305.pdf>
- Ademe, Z. & Hameer, S. (2018). Design, construction, and performance evaluation of a solar cooker with a glazing wiper mechanism. *AIMS Energy*, 6(1), 146-169. https://www.researchgate.net/publication/322919208_Design_construction_and_performance_evaluation_of_aBox_type_solar_cooker_with_a_glazing_wiper_mechanism
- ASAE S580 (2013). *Testing and Reporting Solar Cooker Performance*. American Society of Agricultural Engineers (ASAE). The Society for Engineering in Agricultural, Food and Biological Systems. Renewable Power Generation Committee. 2950 Niles Road, USA. <https://www.asabe.org/Portals/0/aPubs/S580.pdf>
- Aremu, A., & Akinoso, R. (2013). Potential use of box-type solar cooker in developing countries. *The Journal of the Association of Professional Engineers of Trinidad and Tobago*, 41(1), 11-17. http://www.apett.org/home/images/journal/vol41n1/japett_v41n1p.11-17.pdf
- Aremu, A., Ogunlade, C., & Oladapo, A. (2019). Design and experimental testing for building integrated box type solar cooker. *Journal of Multidisciplinary Engineering Science Studies*, 5(3), 2518-2525. https://www.researchgate.net/publication/332112351_Design_And_Experimental_Testing_For_A_Building_Integrated_Box_Type_Solar_Cooker
- Bureau of Indian Standards. (2000). IS 13429 (Part 3). <https://law.resource.org/pub/in/bis/S08/is.13429.3.2000.pdf>
- Das, K., Pradhan, G., Hiloidhari, M., Baruah, D. C., & Nonhebel, S. (2017). Household time requirements for producing cooking fuels in rural areas in developing nations. *European Biomass Conference and Exhibition Proceedings*, 178 - 184. <https://doi.org/10.5071/25thEUBCE2017-1DV.1.30>
- Folaranmi, J. (2013). Performance evaluation of a double-glazed box-type solar oven with reflector. *Journal of Renewable Energy*, 1-8. <http://dx.doi.org/10.1155/2013/184352>
- Francis, C., Jose, V., & Chacko, R. (2015). Experimental analysis of box type solar cooker for performance improvements and off-sunshine cooking. *International Journal of Advance Research in Engineering, Science & Technology*, 2(11), 51-57. https://www.academia.edu/31350773/J5_Solar_cooker_full_Chinnumol
- Funk, P. (2000). Evaluating the international standard procedure for testing solar cookers and reporting performance. *Solar Energy*, 68(1), 1-7. [https://doi.org/10.1016/S0038-092X\(99\)00059-6](https://doi.org/10.1016/S0038-092X(99)00059-6)
- Kimambo, C. (2007). Development and performance testing of solar cookers. *Journal of Energy in Southern Africa*, 18(3), 41-51. <http://dx.doi.org/10.17159/2413-3051/2007/v18i3a3384>
- Kundapur, A., & Sudhir, C. V. (2009). Proposal for new world standard for testing solar cookers. *Journal of Engineering Science and Technology*, 4(3), 272-281. <https://www.cleancookingalliance.org/binary-data/DOCUMENT/file/000/000/88-1.pdf>
- Malicdem, E. (2015). Optimal tilt of solar panels in the Philippines. *Schadow1 Expeditions*. <http://www.s1expeditions.com/2015/02/179-solar-panels-optimal-tilt-philippines.html>
- Rikoto, I. I., & Garba, I. (2013). Comparative analysis on solar cooking using box type solar cooker with finned cooking pot. *International Journal of Modern Engineering Research (IJMER)*, 3(3), 1290-1294. http://www.ijmer.com/papers/Vol3_Issue3/AF3312901294.pdf
- Weldu, A., Zhao, L., Deng, S., Mulugeta, N., Zhang, Y., Nie, X., & Xu, W. (2019). Performance evaluation on solar box cooker with reflector tracking at optimal angle under bahir dar climate. *Solar energy*, 180, 664-677. <https://doi.org/10.1016/j.solener.2019.01.071>
- World Health Organization. (2016). Household energy use. <https://mics.unicef.org/files?job=W1siZiIsIjIwMTcvMDIvMDMvMTYvMjc vMjUvNTk5L1BpY3RvcmlhbHNfV0hPX0hvdXNlaG9sZF9FbmVvZ3lfVXNlX0NhdGFsb2d1ZV9TZXB0ZW1iZXJfMjAxNi8ucGRmIl1d&sha=57b4a452fcc0ac88>
- Yusuf, S. O., Garba, M. M., Momoh, M., & Akpootu, D. O. (2014). Performance evaluation of a box-type solar oven with reflector. *The International Journal Of Engineering And Science (IJES)*, 3(9), 20-25. <http://www.theijes.com/papers/v3-i9/Version-2/C0392020025.pdf>
- Yamamoto, S., Sié, A., & Saeurborn, R. (2009). Cooking fuels and the push for cleaner alternatives: a case study from Burkina Faso. *Glob Health Action*, 2(1). <https://www.ncbi.nlm.nih.gov/pmc/articles/PMC3392076/>

BUSINESS CONCEPT BAZAAR



VARAYTI



Patricia Bianca T. Arce, George Benedict I. Braga, Jenniel Phoebe B. Calica,
Kiara Gabrielle B. Cao, Antonio Miguel A. Reventar, and Joaquin Miguel G. Yap
De La Salle University Integrated School, Biñan City, Laguna

Marife Magiliman-Magsino, *Research Adviser*
De La Salle University Integrated School, Biñan City, Laguna

Executive Summary: VARAYTI was formed in 2020 by aspiring entrepreneurs who wish to go beyond their culture. The business is a sole proprietorship bag and fashion business owned by Phoebe Calica. It provides fashionable and practical fanny packs as flagship products and shirts for product diversification at an affordable price, Php 650 and Php 400, while incorporating Philippine Culture using locally made materials. VARAYTI's goal is to inspire, give appreciation, and pride to the significance of remembering one's culture by Digital Marketing through Facebook and Instagram. VARAYTI penetrates the market by understanding target customers' needs and wants through extensive research. VARAYTI's target market is mainly millennials and GEN Z in CALABARZON, Philippines, but welcomes everyone who wishes to purchase the products. VARAYTI's primary competitors are Grade 12 students of De La Salle University-Laguna. VARAYTEAM consists of the following key departmental positions: Patricia Arce, the Marketing Officer, handles marketing strategy. Kiara Cao oversees Operations and Productions. Joaquin Yap manages internal and external Human Resources endeavors. Miguel Reventar prepares financial statements and budgeting. George Braga monitors Sales and assists in Finance. VARAYTI's starting capital of Php 48,000 with equal contributions of Php 8,000 to run the business for all the supplies needed and manufacturing. VARAYTI officially launched last November 2020 and reached its breakeven of 59 bags. Product diversification was introduced in February 2021. VARAYTI reached its breakeven at the second month of selling and sold all Fanny Pack and Shirts, resulting in Php 21,209.40 profit. VARAYTI will continue operations after the A.Y. 2020-2021.

Key Words: varayti; fanny packs; sole proprietorship; culture; digital marketing

I. BUSINESS REGISTRATION AND ORGANIZATION

VARAYTI has accomplished all of the business's legal permits last November 2020 through Practical Research III: Inquiries, Investigation, and Immersion, through business simulations. VARAYTI's Mayor's Permit is registered under Silang, Cavite, where the Owner

resides. The DTI of the business ensures the protection and interest of the customers. The BIR helps in the improvement of the nation and the lives of the Filipinos.

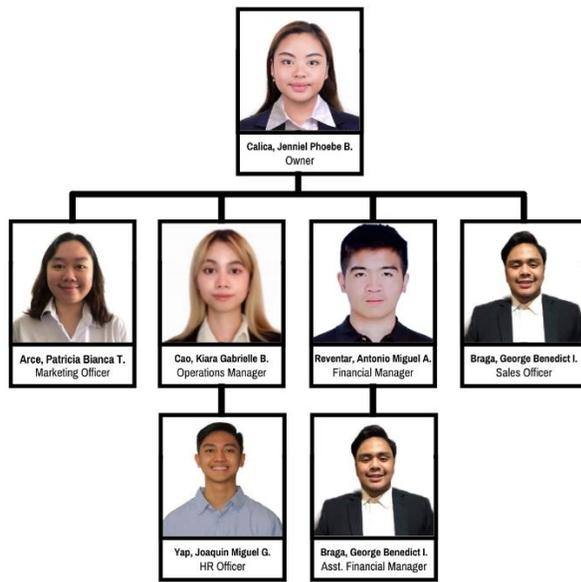

Figure 1. VARAYTI's Organizational Chart

VARAYTI is a sole proprietorship owned by Phoebe Calica, with the team known as VARAYTEAM. Patricia Arce manages the Marketing Department that is in charge of the Marketing Strategy. George Braga manages the Sales Department, which processes the business' activity. Kiara Cao is the Operations Manager, who is in charge of the productions and operations. Miguel Reventar is the head of the Financial Department, in charge of its financial, budgeting and expenditure planning, along with Assistant Financial Manager George Braga. Joaquin Yap, the Human Resources Officer, who oversees the internal and external human endeavor and monitors the tasks and job properly.

II. A. PRODUCTION/OPERATIONS

VARAYTI's Operations is managed by Kiara Gabrielle B. Cao. The production process takes up to two (2) weeks for their bags and one (1) week for shirts sent to VARAYTI's respective manufacturers. Materials for the bags are shipped from local stores and the Yakan textiles are hand-woven and made from Zamboanga and were cut into straps used for the bags. The business purchases plain shirts that are then heat-pressed with designs personally made by the Operations and Marketing Officer. After production, the team goes through the products for quality and inventory checking to ensure that they have produced the best quality they can. VARAYTI utilizes social media by posting publication materials and interacting with customers. VARAYTI provides step-by-step

instructions on how to order in their social media accounts. Interested customers will send the team a message and can choose their preferred mode of payment and delivery.

II. B. MARKETING

VARAYTI is a representation to create and sell a variety of products through the use of local materials. The tagline "What Goes Beyond" showed the belief in inspiring other people to create what is beyond the limits of life. The flagship product, VARAYTI Fanny Pack, has three (3) styles: *Audacia*, *Vivida*, and *Klaro* made to have a Polyvinyl Chloride (PVC) body, Yakan Textile strap from Basilan Zamboanga Philippines, anti-theft zippers, and alcohol-spray bottles as freebies. For the product diversification, VARAYTI Shirts have two (2) designs, *Caliente* and *Lluvia* in both black and white colors, which are heat-pressed cotton shirts. All were inspired by giving awareness to Philippine culture, remembering its significance and its identity, which were also named in Chavacano, a Spanish-based creole language, one of many varieties that Zamboanga residents speak. Packaging used to keep it safe through deliveries around CALABARZON, Philippines and outside areas through couriers like J&T was corrugated boxes with warranty cards for the bags and frosted zip locks for the shirts. These were in compliance with environmental regulations and in reaching United Nations Sustainable Development Goals: Goal 12 Responsible Consumption and Production, Goal 13 Climate Action, Goal 14 Life Below Water, and Goal 15 Life on Land. The selling prices were Php 650 with a 44% markup rate and Php 400 with a 36.52% markup rate, respectively. A cost-based pricing strategy was used in which the selling price was relatively low to penetrate the market and ensure profitability.

For the promotion, Digital Marketing was used due to the pandemic to connect directly with customers and expand more of the business. Facebook and Instagram social media accounts were created in September 2020. The Marketing Officer, Patricia Arce, with the help of the Operations Manager, Kiara Cao, then created different publication materials for engagement, as well as taking advantage of special occasions and seasons in the promotion. It resulted in 445 followers on Instagram and 716 likes, along with 1,268 followers on Facebook.

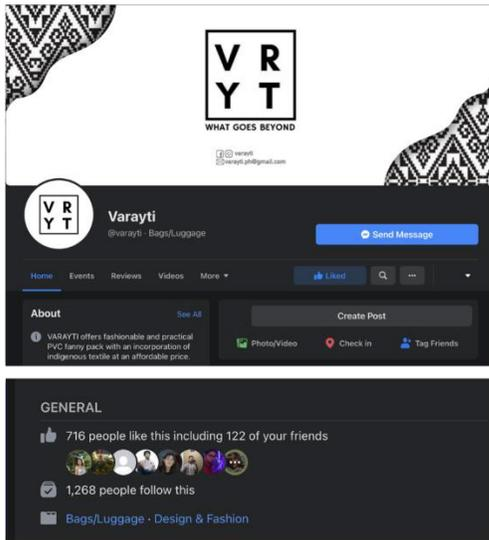
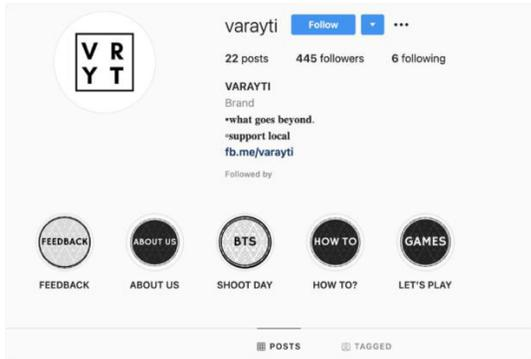

Figure 2. VARAYTI Instagram and Facebook Platforms



Figure 3. VARAYTI's Flagship Product Publication Materials



Figure 4. VARAYTI's Product Diversification Publication Materials

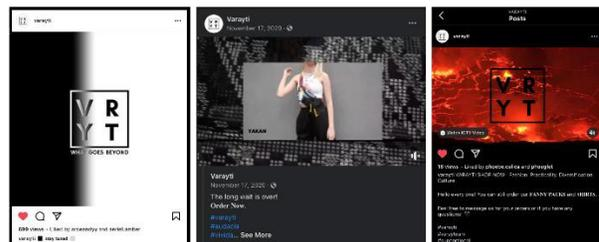

Figure 5. VARAYTI Video Teasers and Video Pitch



Figure 6. *Samples of VARAYTI Seasonal Publication Materials*

II. C. HUMAN RESOURCES

The business's Human Resource is managed by Joaquin Yap. The owner, Ms. Phoebe Calica, ensures that every department contributes to tasked assignments to finish tasks before deadlines. She is also in-charge in ensuring that the business runs smoothly. Moreover, there were no agreed compensation packages for the management team of VARAYTI. However, the group decided to divide the remaining inventory equally by the end of the Academic Year. In doing so, this will promote fairness and responsibility to the members of the group. The group conducts frequent meetings, often with the instructor, within the week in order to plan the activities and assign tasks respectively. These meetings are necessary for the report of both the weekly and monthly progress of the business. A calendar of activities, such as the use of Gantt Charts, was used to provide awareness and promote organization for the group in order to achieve the target or the objective of the business.

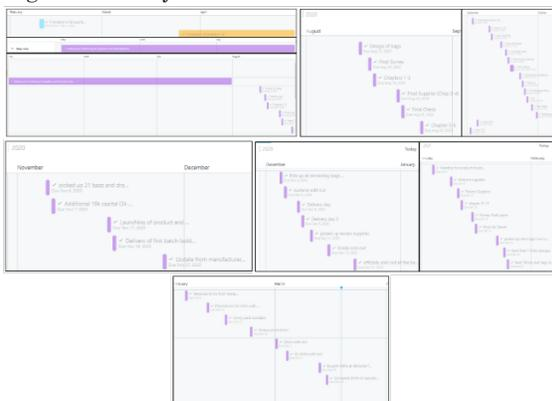

Figure 6. *VARAYTI Gantt Charts from February 2020 to March 2021*

III. D. FINANCE

Based on the consumer's seasonal demands, the Financial Manager forecast revenue for VARAYTI in the years 2020-2021, from October 2020 to March 2021.

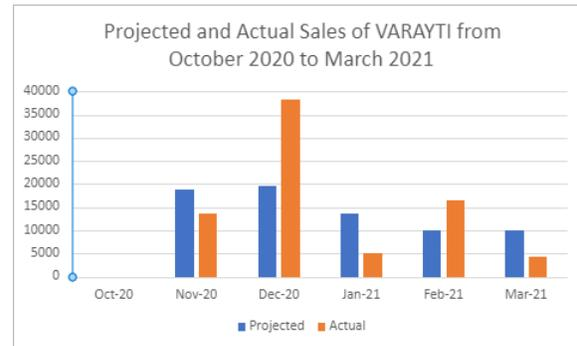

Figure 7. *Projected and Actual Sales of VARAYTI from October 2020 to March 2021*

Given the projections, VARAYTI had expected to have sold half of their breakeven by the end of November 2020. Despite not being able to reach this, they were able to reach their break-even point and sell all of their inventories by the end of December 2020. With that, the projected sales for January 2021 were not met. However, with the release of VARAYTI's product diversification at the start of February 2021, the business's sales exceeded the projected outcome, leading to less than the projected sales for March 2021. With that said, VARAYTI's actual sales were able to surpass their overall projected outcome which led to a net profit of 8,409.40php, a net profit ratio of 10.17%, and a return on investment of 17.52%. A significant number of buyers were satisfied by the business, and their sold units were higher than their point of breakeven.



Figure 8. *VARAYTI Fanny Packs and Shirts Breakeven Line Graphs*



3RD DLSU SENIOR HIGH SCHOOL RESEARCH CONGRESS

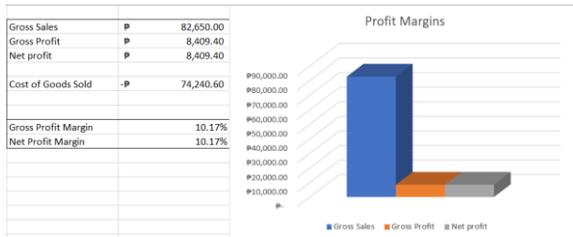

Figure 9. VARAYTI's Profit Margins

Net profit	₱	8,409.40
Total Investment	₱	48,000.00
Return of Investment		17.52%

Net profit	₱	7,998.93
Total Investment	₱	48,000.00
Return of Investment		16.66%

Figure 10. VARAYTI Return of Investment as of March 2021 with (Before and After Tax)

VARAYTI Income Statement For The Month Ended March 31, 2021		VARAYTI Statement of Financial Position From October 2020 to March 2021	
Revenue & Gains		Assets	
Gross Sales	₱82,650.00	Cash and cash equivalents	₱41,233.00
Total Revenues & Gains	₱82,650.00	Inventory	₱204,340.00
Expenses & Losses		Total Current Asset	₱245,573.00
Supplies Expense	(₱54,475.00)	Total Assets	₱245,573.00
Manufacturing Expense	(₱19,765.60)	Liabilities and Shareholder's Equity	
Tax expense	(₱4,409.47)	Liabilities	
Total Expenses & Losses	(₱74,661.07)	Total Liabilities	₱0.00
Net Income	₱7,988.93	Shareholder's Equity	
		VARAYTI, Capital	₱0.00
		ADD: Net income	₱7,988.93
		Total Shareholder's Equity	₱7,988.93
		Total Liabilities and Shareholder's Equity	₱7,988.93

Figure 11. VARAYTI's Income Statement and Statement of Financial Position as of March 2021

III. FUTURE PLANS

VARAYTI will become a fashion and lifestyle brand that will continuously create various types of products. As it expands as a brand, the process of registration of trademarks for the logo, brand name, and product designs will be finalized, ensuring that VARAYTI is protected. The team will also officially file their legal permits after the business simulation has ended, continuing on implementing their experience-based CSR program for less fortunate aspiring entrepreneurs called, "PANGKALAHATAN". VARAYTEAM believes that education and knowledge are part of one's success, potentially reaching out to what is beyond. They would also be hiring future employees, giving them proper compensations and benefits. The closing of the business will be implemented by the end of the Academic Year 2020-2021, however, it is a chance to improve the business and showcase its best version to the public before reopening in the future.

IV. ACKNOWLEDGEMENTS

VARAYTI's business would not be possible without the help of the people who supported the business and continued to support it throughout the process. The team would like to significantly acknowledge the parents, relatives, customers, friends, and the people who believed in the business's growth and have helped expand the market, making the business more known to other parts of the country. VARAYTEAM was also able to accomplish the research completion with their research adviser, Ms. Marife Magsino. With continuous support and help to grow and become the best version of themselves, it has led to the business's success and will continue to succeed until the next coming years. The suppliers and manufacturers who produced VARAYTI's high-quality Fanny Packs and Shirts are also acknowledged by the team, making it possible to create these products amidst the pandemic and giving the experience of how business operations truly work. Finally, VARAYTI would not be complete without the VARAYTEAM. The efforts of the members throughout the Academic Year 2020-2021 are highly acknowledged and appreciated. VARAYTI is thankful to have the opportunity to provide people high-quality, practical, and fashionable products throughout the entire year, creating products that can make an impact and inspiration towards culture. The team ensures to continue its mission and vision for the market, expand more, and go beyond the limits.

VI. REFERENCES/APPENDICES

Ahmad, U. F. (2017). CLEAN ENVIRONMENT: ESSENTIAL TO SUSTAINABLE DEVELOPMENT. TEACH SDGs. <http://www.teachsdgs.org/blog/clean-environment-essential-to-sustainable-development>.

Aileen. (2013). Symbolism in the Rain. All Things Required: all things required. <https://thingsinnecessity.wordpress.com/2013/12/10/symbolism-in-the-rain/>.

Asian Disaster Reduction Center (ADRC). (2013). Adrc.asia. <https://www.adrc.asia/nationinformation.php?NationCode=608&Lang=en#:~:text=Located%20along%20the%20typhoon%20belt,five%20of%20which%20are%20destructive>.

Nelson, S. (2018). 7 reasons why social media marketing is important for your business. Digital Doughnut. <https://www.digitaldoughnut.com/articles/2018/february/7-reasons-why-social-media-marketing-is-important>.

Venefica, A. (2008). Symbolic Volcano Facts and Thoughts - The Blog for Whats-Your-Sign.com by Avia. The Blog for Whats-Your-Sign.com by Avia. <https://www.symbolic-meanings.com/2008/10/10/symbolic-volcano-facts-and-thoughts/>



HO TSIA



Eunice Lao, Winnie Angelica Li, Charles Daryl Dee, Benson Sean H. Huang, Sam Jayson D. Hong, Josephine C. Tan, Shanni Shi, and Wa Kim D. Chua
Philippine Cultural College, Manila

Executive Summary: Ho Tsia was formed in November 2020 to participate in the Online Christmas Bazaar. The business offers the essence of Chinese cuisine into people's daily lives with easily accessible Chinese meals.

The company is located in Binondo, Manila. According to Ho Tsia's previous market research, people living in Metro Manila would like authentic Chinese dim sums that are affordable and delivered to their homes without taking the risk of going outside during the pandemic. With this information, the company decided to target people ages 18-34 and Chinese Filipinos. Although competitive rivalry is high, Ho Tsia has employed the use of digital marketing that allows the company to establish its brand through social media platforms permanently.

The company is a corporation invested by the eight owners through corporate financing. It financially issues cash dividends to executive members. Currently, the executive members have invested a total of P400,000 towards the business.

Key Words: Ho Tsia; dim sum business; cash dividends; online selling; income projections

I. BUSINESS REGISTRATION AND ORGANIZATION

I. A. Organizational Chart

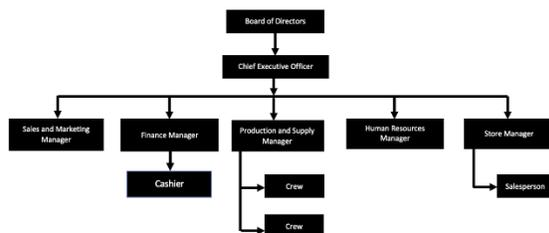

To ensure corporate stability, proper allocation of human resources is essential. The company utilizes a hierarchical form of management wherein members of the organization comprise ten people. This start-up business has planned to hire

only two employees.

I.B. Business Description

The Hokkien word "ho tsia" in English means delicious. Ho Tsia is two words together, "ho" means good, and "tsia" means eat. Ho Tsia is a business first established to participate in the Online Christmas Bazaar that sells frozen dim sum. The company has chosen to sell dim sums as Chinese cuisine is welcomed by the Filipino community, with 88% of Filipinos who have tried Chinese cuisine loving it (Smith, 2019).

I.B.1. Business Tagline

The business's official tagline is "want sum, get sum, dim sum."



I.B.2. Business Logo



The logo is a platter of the iconic dumplings on a bamboo steamer to represent dim sum, while the chopstick represents Chinese eating utensils. The company utilizes a red and yellow color theme since it symbolizes the festivity of gathering together, a crucial factor in Chinese culture.

I.B.3. Vision

To be one of the leading quality service and product providers that offer consumers an affordable experience accessing handmade Chinese dim sums.

I.B.4. Mission

To deliver the essence of Chinese cuisine into people's daily lives with easily accessible Chinese meals.

I.B.5. Objectives

1. To ensure great customer service through consistent training and management of staff.
2. To establish a strong market presence in Chinatown.
3. To ensure customer satisfaction and build a repeat customer base.
4. To obtain a stable increase in sales.
5. To ensure Ho Tsia's financial stability.
6. To ensure the sanitary of the products by implementing strict quality control during food production.

I.C. Business Concept

Ho Tsia is a stock corporation that issues cash dividends based on shares. Ho Tsia is established with a fixed capital from the eight owners where the profit from the products sold is divided equally for each shareholder.

I.D. Legal Requirements for Business Registration

For Ho Tsia to legally operate, it would need the following:

- Register with the Securities and Exchange Commission (SEC)
- Business Permit
- Register with the Bureau of International Revenue (BIR)
- Register with the Social Security System (SSS)
- Register with the Philippine Health Insurance Corporation (PhilHealth)
- Register with the Home Development Mutual Fund (Pag-IBIG Fund)
- Register with the Bureau of Food and Drugs (BFAD)

I.E. Compensation and Ownership

Name	Investment	%
Eunice Lao	₱50,000	12.5
Winnie Angelica Li	₱50,000	12.5
Charles Daryl Dee	₱50,000	12.5
Benson Sean H. Huang	₱50,000	12.5
Sam Jayson D. Hong	₱50,000	12.5
Josephine C. Tan	₱50,000	12.5
Shanni Shi	₱50,000	12.5
Wa Kim D. Chua	₱50,000	12.5
Total	₱400,000	100

II. BUSINESS PLAN IMPLEMENTATION

II.A. Production

II.A.1. General Business Condition

All dim sum products shall be stored, handled, transported, and protected from spoilage and contamination. The staff shall not leave any used ingredients overnight. Everything inside the kitchen would be cleaned and sanitized every day before and after operating hours. Every person engaged in the food production process shall clean their workstation. No kitchen staff operator may permit any person affected with any contagious, infectious or physical ailment which may render such employment detrimental to the customers to work. Employees shall be prohibited from smoking, drinking, getting drugged during work hours.



II.A.2. Production Method

The company's production process is as follows:

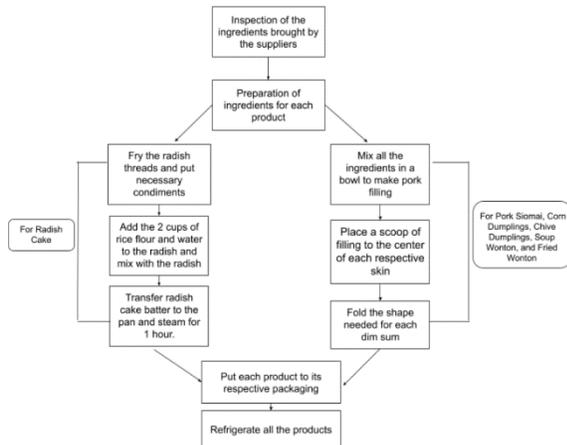

II.A.3. Production Cost

Chive Dumplings		
Ingredients		
Dumpling skin		31
Chives		46.35
Pork		67.47
Oil		7
Salt		5
Seasoning		3.23
Packaging		10
Total Direct Cost		170.05
Utilities Expense		4.38
Rent Expense		20.83
Advertising Expense		1.04
Salaries Expense		53.7
Total Overhead Cost		79.95
Total Production Cost		250
Markup on Cost		20%
Selling Price		300

Corn Dumplings		
Ingredients		
Dumpling skin		31
Corn		49.55
Pork		64.27
Oil		7
Salt		5
Seasoning		3.23
Packaging		10
Total Direct Cost		170.05
Utilities Expense		4.38
Rent Expense		20.83
Advertising Expense		1.04
Salaries Expense		53.7
Total Overhead Cost		79.95
Total Production Cost		250
Markup on Cost		20%
Selling Price		300

Fried Wonton / Soup Wonton		
Ingredients		
Wonton wrappers		8.42
Pork		20.19
Oil		7.2
Salt		2
Seasoning		2.24
Packaging		10
Total Direct Cost		50.05
Utilities Expense		4.38
Rent Expense		20.83
Advertising Expense		1.04
Salaries Expense		53.7
Total Overhead Cost		79.95
Total Production Cost		130
Markup on Cost		92.31%
Selling Price		250

Radish Cake		
Ingredients		
Radish		33.93
Rice flour		15.52
Sugar		1.4
Pepper		3.7
Salt		2
Oil		3.5
Packaging		10
Total Direct Cost		70.05
Utilities Expense		4.38
Rent Expense		20.83
Advertising Expense		1.04
Salaries Expense		53.7
Total Overhead Cost		79.95
Total Production Cost		150
Markup on Cost		53.33%
Selling Price		230

Pork Siomai		
Ingredients		
Wonton Wrapper		25
Shrimp		50.62
Pork		49.25
Oil		7
Salt		5
Seasoning		3.18
Packaging		10
Total Direct Cost		150.05
Utilities Expense		4.38
Rent Expense		20.83
Advertising Expense		1.04
Salaries Expense		53.7
Total Overhead Cost		79.95
Total Production Cost		230
Markup Cost		21.74%
Selling Price		280

II.A.3.a. Ingredient Costing

Supplier:	Product:	Selling Price and amount:	Price	Production Cost and amount:
City Store 888, 1006 Alvarado St, Binondo, Manila, 1006 Metro Manila	Dim sum wrapper	P62 (50 sheets)		P31 (25 sheets)
	Oil	P35 (350 ML)		P7 (70 ML)
	Salt	P50 (170 GRAMS)		P5 (17.07 GRAMS)
	Shapowei Seasoning	P165 (500 GRAMS)		P5.23 (15.08 GRAMS)
	Rice Flour	P60 (1 kg)		P15.52 (250 GRAMS)
	Pepper	P90 (100 GRAMS)		P3.7 (4.11 GRAMS)
	Chive	P90 (500 GRAMS)		P46.35 (257.5 GRAMS)
	Corn	P100 (1kg)		P49.55 (1/2 kg)
	Radish	P65 (1kg)		P33.93 (52.2 GRAMS)
	Sugar	P50 (600 GRAMS)		P1.4 (16.8 GRAMS)
HAO YOU DUO 460 Elcano St. cor San Fernando, Binondo, Manila	Plastic Container	P60 (10 PCS)		P6 (one per order)
	Plastic Bag	P100 (100 PCS)		P2 (two per order)
	Styrofoam Container	P600 (100 PCS)		P6 (one per order)
	Newspaper	P33.33 (100 SHEETS)		P2 (six per order)
	Ground Pork	P200 (1/2 kg)		P64.27 (1/6 kg)
	Sua he /Shrimp	P410 (8 pcs)		P50.62 (1 pcs)

II.B. Marketing

II.B.1. Competitive Advantage

Ho Tsia's advantage in the competitive industry is that it provides consumers with complete transparency with handling food production. According to Ahmed (2020), consumer trust is a significant factor in determining whether a business would succeed or not. Food safety continues to be on the minds of consumers, especially in recent events like the COVID-19 virus and the African swine fever virus. The company believes that consumers are hesitant to buy food online since they are unfamiliar with the business's practices on food hygiene. The company will provide transparency to its consumers by posting insider videos about the business, such as the production process.

II.B.2. Product

Ho Tsia sells a variety of six dishes of authentic Chinese frozen dim sums. This includes soup wonton, fried wonton, pork siomai, radish cake, corn dumplings, and chive dumplings.

II.A.4. Operational Activities

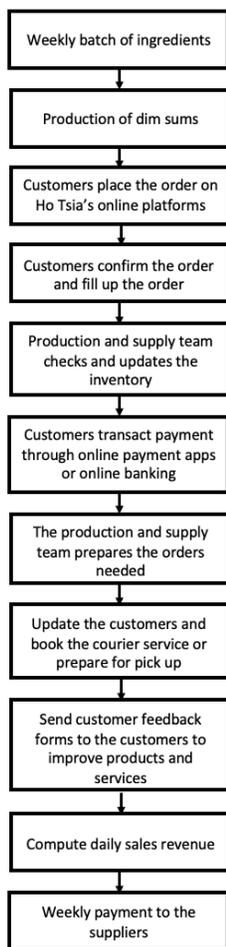

	Corn-filling Dumplings
	Chive-filling Dumplings
	Radish Cake
	Soup Wonton
	Fried Wonton
	Pork Siomai



II.B.3. Price

The business utilized a competition-based pricing strategy wherein its pricing of the frozen dim sums is based on comparing existing competitors' prices.

Products cost around PHP 230 - PHP 300. Ho Tsia's products' prices will be dependent on the market price of the ingredient.

Since the company sells homogeneous items, barriers arise where people would instead buy from older, trusted brands due to familiarity. That is why the company has employed the use of the volume discount pricing strategy.

II.B.4. Place



As Ho Tsia wants to target the Chinese-Filipino community, the company has decided to place the physical store near the Lucky Chinatown Mall and 168 Mall, located in the heart of Binondo, for some customers to order and pick up their orders. This specific location has been chosen since it is a diverse place where many Chinese Filipinos dwell in. Customers have the option of picking up or ordering online and delivering it to their doorsteps.

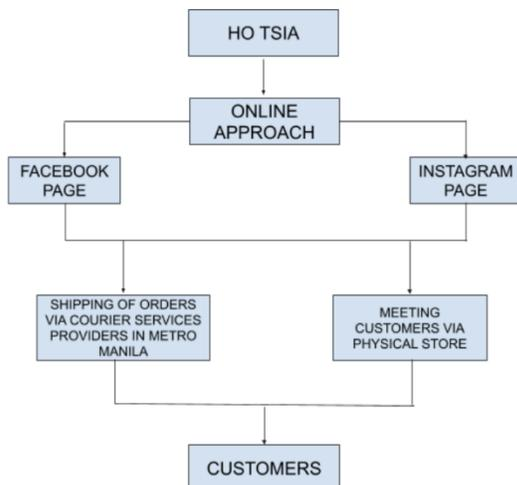

The distribution channel of Ho Tsia will be through online selling with the help of various social media platforms and delivered by food delivery service apps.

II.B.5. Promotion

II.B.5.a. Online Advertising Strategy

Ho Tsia would be launching their business on platforms like Facebook and Instagram. It primarily targets people ages 18-34 since this age range has the largest age proportion of social media users (Seavers, 2019). Digital posters, infographics, teasers, and insider videos would be posted on these platforms to establish brand recognition, showcase business transparency, and build deeper relationships between the business and customers.

Social Media Accounts

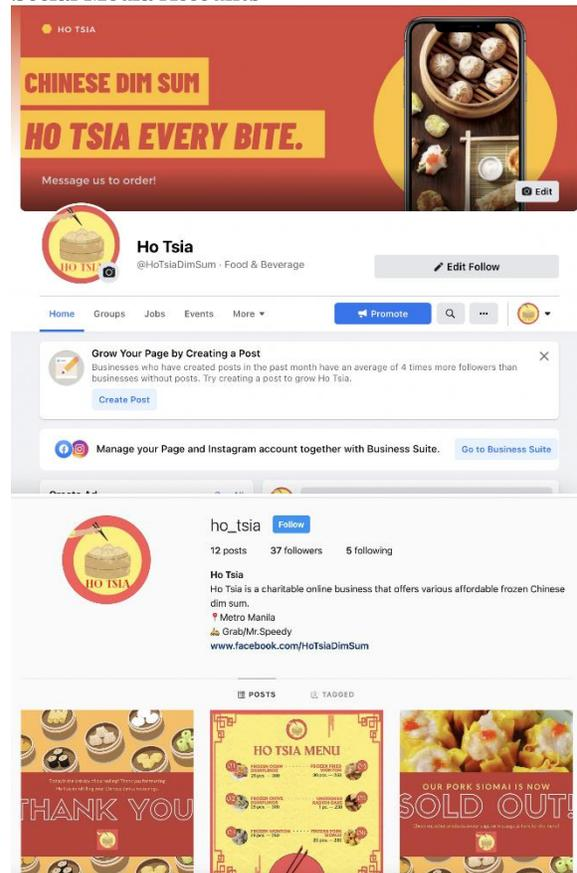

Digital Posters

These were posters used during the selling week of the Online Christmas Bazaar.

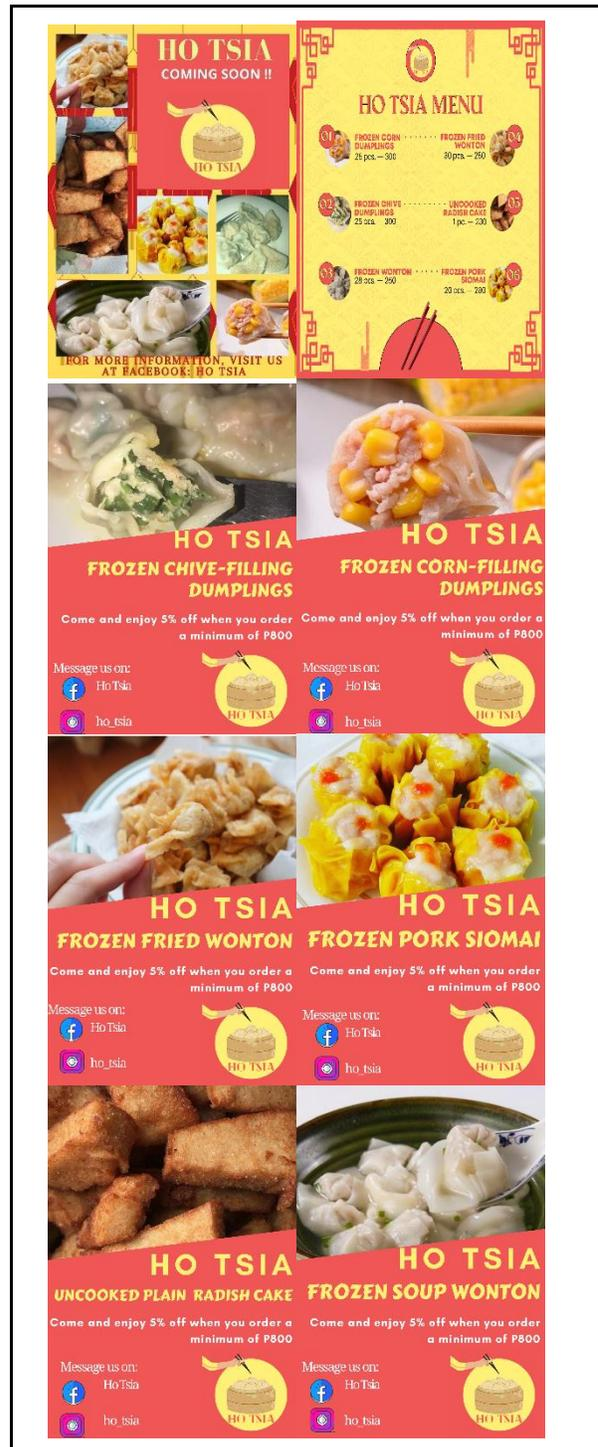

II.B.5.b. Offline Advertising Strategy

For offline advertising, the business employed the use of discounts to attract new and repeat customers. The company would create a loyalty program wherein customers will be given loyalty cards that offer frequent buyers



additional benefits to increase customer retention. Ho Tsia would create combo deals from time to time where the company would heavily advertise the business to build brand awareness. Partnership marketing would also be applied wherein the company collaborates with other businesses and offers products as combo deals. This would be used since it is more cost-effective than traditional marketing.

II.C. Human Resources

II.C.1. Recruitment and Selection of Employees

Currently, Ho Tsia plans to recruit two employees: one salesperson and one crew member. The staff should meet the following criteria:

II.C.1.a. Requirements:

- Excellent customer service skills
- Prior experience in retail or sales
- Has the patience to handle multiple customers at a time
- Ability to follow all appropriate safety standards in food production
- Experience in the kitchen and cooking

II.C.1.b. Wage and Compensation Benefits:

- Monthly salary PHP 28,000; Overtime pay; Premium pay; 13th-month pay; Separation pay; Retirement pay

II.C.1.c. Leave Benefits:

- Service incentive leave; Parental leave; Special leave benefits for women; Bereavement leave

II.C.1.d. Mandatory Government Contributions:

- Social security system (SSS); PhilHealth; Pag-IBIG

II.C.2. Human Resources Process



II.C.3. Staff Development

Ho Tsia has enforced policies and guidelines for the staff to follow and activities to improve the staff's skills and work relationships.

II.C.3.a. Having a Clear Understanding of the Company's Vision and Mission

The staff should know what the company has and will offer. Communication is a crucial factor for effective management. It is advantageous because it avoids misunderstandings and encourages a healthy and more productive work environment. Ho Tsia will be hosting weekly meetings for weekly business reports and strategizing or brainstorming for action plans.

II.C.3.b. Ensuring Food Safety and Develop Sanitation Training Programs

Regulations for food safety would be ensured by educating staff with proper sanitation programs annually. Ho Tsia would design a food safety program that teaches its employees everything regarding food safety activities. This guarantees the safety of the customers' health, ensures the longevity of food products, and protects the business's reputation.

II.D. Finance

II.D.1. Source of Funds

Owners of Ho Tsia all invested PHP 50,000 each, putting together a capital of PHP 400,000.

II.D.2. Uses of Funds

II.D.2.a. Uses of Funds for 3 months

Marketing Study			
Advertising Expense (Note 1)			₱1,500
From Technical Study			
Furniture, Fixtures, and Equipment (Note 2)	₱75,820		
Inventories (Note 3)	154,872		
Supplies (Note 4)	1,150	231,842	
Organizational and Management Study			
Salaries Expense			77,328
Additional			
Utilities Expense (Note 5)	₱6,300		
Rent expense	30,000	36,300	
Total			₱346,970



II.D.2.b. Uses of Funds for 1 year

Marketing Study		
Advertising Expense		₱6,000
From Technical Study		
Furniture, Fixtures, and Equipment	₱75,820	
Inventories	619,488	
Supplies	4,600	699,908
Organizational and Management Study		
Salaries Expense		309,312
Additional		
Utilities Expense	₱25,200	
Rent expense	120,000	145,200
Total		₱1,160,420

II.D.3. Statement of Financial Position prior Operations

Ho Tsia		
Statement of Financial Position		
As of January 1, 2021		
Current Assets		
Cash	₱306,674	
Inventories	12,906	
Supplies	4,600	₱324,180
Non-Current Assets		
Equipment	₱67,820	
Furniture and Fixtures	8,000	75,820
Total Asset		₱400,000
Total Equity		₱400,000

The table above only listed one week's worth of inventory since the ingredients are perishables.

II.D.4. Financial Assumptions

- Selling price per unit —
 - corn dumplings - PHP 300
 - chive dumplings - PHP 300
 - siomai - PHP 280
 - soup wonton - PHP 250
 - fried wonton - PHP 250
 - radish cake - PHP 230
- Units of products sold in 2021 — 5,760 units
 - corn dumplings - 720 units
 - chive dumplings - 720 units
 - siomai - 1,440 units
 - soup wonton - 720 units
 - fried wonton - 1,440 units
 - radish cake - 720 units
- Cost ratio —
 - corn dumplings - 56.68%
 - chive dumplings - 56.68%
 - pork siomai - 53.59%
 - soup wonton - 20.02%
 - fried wonton - 20.02%
 - radish cake - 30.46%
- Average annual sales growth rate — 15.22%
- Advertising expense in 2021 — PHP 6,000
- Advertising expense will decrease by 60% per year

- Salaries expense in 2021 — PHP 253,440
- Average annual salaries expense growth rate — 5.6%
- Rent expense in 2021 — PHP 120,000
- Average annual rent expense growth rate — 0% since signed a 5-year contract implying no change in rent
- Utilities expense in 2021 — PHP 25,200
- Average annual utilities expense growth rate —
 - Electric — 27.44%
 - Water — 0%
 - WiFi — 0%
- Long-term assets depreciate PHP 7,582 yearly with an average useful life of 10 years
- Tax expense is 30%

II.D.5. Income Projections

	2021	2022	2023
Net Sales	₱1,540,800	₱1,775,310	₱2,045,512
Cost of Goods Sold	619,488	713,774	822,410
Gross Profit	₱921,312	₱1,061,536	₱1,223,101
Advertising Expense	₱6,000	₱2,400	₱960
Salaries Expense	309,312	326,633	344,925
Rent Expense	120,000	120,000	120,000
Electric	₱11,200	₱14,273	₱18,190
Water	2,000	2,000	2,000
Wifi	12,000	12,000	12,000
Utilities Expense	₱25,200	₱28,273	₱32,190
Depreciation Expense	7,582	7,582	7,582
Operating Expense	₱468,094	₱484,888	₱505,657
Operating Profit	453,218	576,647	717,444
Tax Expense	135,965	172,994	215,233
Net Profit	₱317,253	₱403,653	₱502,211

II.D.6. Financial Ratios

	2021	2022	2023
Gross Profit Margin	59.79%	59.79%	59.79%
Operating Profit Margin	29.41%	32.48%	35.07%
Net Profit Margin	20.59%	22.74%	24.55%
Times Interest Earned	N/A	N/A	N/A

According to Nicasio (2019), the retail industry's average gross profit margin ratio is 53.33%. This table shows that the business is efficient in producing goods before deducting extraneous costs with a ratio of 59.79%.

The Motley Fool (2020) states that the operating profit margin ratio over 15% is considered good. The operating profit margin of 2021-2023 has a steady increase from 29.41% to 35.07%, showing that the business has better chances of surviving market challenges or seasonal fluctuations in revenue.

As a general rule of thumb, a 20% net profit margin is considered high (Tide, 2021). As seen in the table above, the company has a 20.59% profit margin in the first year and will steadily increase. With these computations, the business will likely succeed and would not encounter any financial



difficulties.

II.D.7. Break-Even Analysis

In Ho Tsia's case, it needs to sell approximately 244 units of product each month to reach break-even. The product mix was based on the units sold from the financial assumptions above.

	Chive-filling Dumplings	Corn-filling Dumplings	Fried Wonton	Soup Wonton	Radish Cake	Pork Siomai	
Price per Unit	P300	P300	P250	P250	P230	P280	
Variable Cost per Unit	170.05	170.05	50.05	50.05	70.05	150.05	
Contribution Margin per Unit	P129.95	P129.95	P199.95	P199.95	P159.95	P129.95	
Product Mix	12.50%	12.50%	25.00%	12.50%	12.50%	25.00%	
Weighted Average Price	P38	P38	P63	P31	P29	P70	P288
Weighted Average Cost	P21	P21	P13	P6	P9	P38	P108
WA Contribution Margin							P199.95
Fixed Cost							P30,008
BE in Units							243.88
BE in Units	30.48	30.48	60.97	30.48	30.48	60.97	243.88
BE in Peso	P9,145	P9,145	P15,242	P7,621	P7,011	P17,071	P65,237

Revenue	P65,237
Variable Cost	P26,229
Contribution Margin	P39,008
Fixed Cost	P39,008
Net Income	P0

FIXED COST	
Utilities Expense	P2,100
Rent Expense	P10,000
Advertising Expense	P500
Salary Expense	P25,776
Depreciation Expense	P632
Total	P39,008

III. PRODUCT DIVERSIFICATION

The company plans to introduce two new product varieties: the tea variety and the noodle variety. Customers will be choosing from various tea flavors and noodles that are ready-to-eat to go with their dim sum orders. With these extra product lines, customers will order dim sums not only as side dishes but also as main dishes paired out with the different types of teas available.

The company's product diversification aims to mimic the essence of an authentic Chinese restaurant during the pandemic. The company presupposes putting them as a meal would entice buyers to buy them, resulting in a boost of sales for the business.

With these new product varieties, the company would be one step closer to achieving its mission statement — to deliver the essence of Chinese cuisine into people's daily lives with easily accessible Chinese meals.

IV. FUTURE PLANS

The company is currently planning for the growth and expansion of the business. This is done while keeping in mind the social responsibility of prioritizing food's safety and quality.

IV.A. Expansion of Product Line

The company has six dim sum variations. The company plans to introduce new variants to diversify its menu to suit the taste of its customers. The company firmly believes that bringing more trendy product options like vegan, vegetarian, and halal would reach a wider audience.

IV.B. Create Value-Added Services

To increase the customer base, the company opted to create an after-purchase service where customers can reach out and ask for cooking tutorials or be provided with professional advice.

IV.C. Partnership with Local Producers

This contributes to the corporate social responsibility of putting money back into the community. Partnering with local producers may cut costs to maximize profits while providing many locally-owned farms financial stability.

IV.D. Expanding to Different Food Service Applications

The business could expand its online presence by launching its services to existing food delivery apps. Reaching out to different platforms would broaden the company's customer reach while quickly gaining brand recognition.

V. ACKNOWLEDGEMENT

The researchers would like to express our gratitude to all the people who have supported the researchers in the conceptualization throughout this study.

This study is made possible by the guidance and supervision of the following:

Mr. Oscar Deo Dacuba, the adviser of the researchers, for his never-ending guidance and support that were essential to the development of the study.

Mr. Leonard C. Catubay, LPT, our teacher in the course Entrepreneurship, who has greatly shared his knowledge with us in helping us improve our paper.

Parents, for their utmost support emotionally, morally, and financially. Without their love and support, the researchers would not be able to accomplish this study.



Classmates of the researchers, for their continuous help and support, whenever the researchers needed guidance.

Philippine Cultural College, for giving us an opportunity to conduct this study.

VI. REFERENCES

Electronic Published Resources

- Ahmed, R. (2020). Is customer trust really the determining factor for your eCommerce? weDevs. <https://wedevs.com/90704/is-trust-really-the-determining-factor-for-your-ecommerce/>
- eCompareMo. (2019). Employee benefits in the Philippines: Complete list, guide, and FAQs. <https://www.ecomparemo.com/info/heres-a-full-list-of-mandatory-benefits-for-regular-employees-in-the-philippines#:~:text=The%20benefits%20given%20by%20SSS,funeral%20grant%2C%20and%20salary%20loan>
- Lagare, J. B. (2020). Manila water: No 2021 rate increases for now. The Manila Times. <https://www.manilatimes.net/2020/11/05/business/business-top/manila-water-no-2021-rate-increases-for-now/791627/>
- Legal requirements for starting a business in the Philippines. (2017). FilePino. <https://www.filepino.com/business-registration/legal-requirements-for-starting-a-business-in-the-philippines/>
- Net profit margin: What it is & how to calculate it. (2021). [Blog]. Tide. <https://www.tide.co/blog/business-tips/net-profit-margin#:~:text=A%20good%20margin%20will%20vary,a%205%25%20margin%20is%20low>
- Nicasio, F. (2019). How to increase your profit margins: 10 strategies to improve profitability [Blog]. Vend. <https://www.vendhq.com/blog/increase-profit-margins/>
- Philippines corporate tax rate. (1997–2020). [Statistics]. Trading Economics. <https://tradingeconomics.com/philippines/corporate-tax-rate>
- Rivera, D. (2021). Meralco hikes rates, will resume disconnections. The Philippine Star. <https://www.philstar.com/headlines/2021/01/09/2069193/meralco-hikes-rates-will-resume-disconnections>
- Seavers, D. (2019). Social media statistics in the Philippines [Blog]. Talkwaker. <https://www.talkwalker.com/blog/social-media-statistics-philippines>
- Smith, M. (2019). Italian cuisine is world's most popular [Statistics]. YouGov. https://yougov.co.uk/topics/food/articles-reports/2019/03/12/italian-cuisine-worlds-most-popular?utm_source=twitter&utm_medium=website_article&utm_campaign=global_cuisine
- Statista. (2021–2025). Food & beverages [Statistics]. Statista. <https://www.statista.com/outlook/dmo/ecommerce/food-personal-care/food-beverages/philippines>
- Wages seen rising 5.6% in 2021. (2020). BusinessWorld. <https://www.bworldonline.com/Wages-Seen-Rising-5-6-in-2021/>
- What operating margin tells you about your business. (2020). The Motley Fool. <https://www.fool.com/the-blueprint/operating-margin/#:~:text=For%20most%20businesses%2C%20an%20operating,is%20going%20up%20or%20down>
- Image Gathered Online
- Apple Daily. (2020). Dumplings are very common, but to taste the essence is rare! This shop's so called "the king of stuffed dumplings" made it! [Photograph]. Apple Daily. <https://tw.appledaily.com/headline/20200226/DAUWZCQIMQ4D3L772MZSOS3DPM/>
- DaisyDannnnnnn. (2019). Fried wonton [Photograph]. Xiachufang. <https://www.xiachufang.com/recipe/104148983/>
- Google Maps. (n.d.). [Crystal Mansion 2, Binondo, Manila]. Retrieved from <https://www.google.com/maps/place/Crystal+Mansion+2/@14.6019249,120.9802112,16.08z/data=!4m8!1m2!2m1!1scrystal+mansion!3m4!1s0x3397ca0e393f8ded:0xcac944fe71e06f03!8m2!3d14.6026692!4d120.9724402>
- MIXIFood. (2020). SIOMAI!!!! [Photograph]. Facebook. <https://www.facebook.com/MIXIFood-108028530970319/photos/108044200968752>
- Wang, J. G. (2012). Deep fried wonton [Photograph]. Flickr. <https://www.flickr.com/photos/pcfannet/33817064985>



EUNOIA



John Eliquiel Jose C. Austria, Catherine G. Calixtro, John Matthew Hilbero, Czar Emjel P. Mercado, Katriel R. Santos, and John Benedict Y. Young II
De La Salle University Integrated School, Biñan City, Laguna

Ms. Marife M. Magsino, Research Adviser
De La Salle University Integrated School, Biñan City, Laguna

Executive Summary: EUNOIA started in February 2020 with strategic plans in starting up a business. It aimed to create a product that is affordable, innovative, eco-friendly, and unique. It belonged to the accessory/bag industry. Eunoia offers tote bags for only 518 Pesos; when accessories are added, it is 618 Pesos (Power-bank included) or 678 Pesos (Alcohol Mist included). The accessories can be sold separately at 100 Pesos and 150 Pesos, respectively. EUNOIA’s product diversification, Calla Lily, is being sold for only 99 Pesos, using the vast digital platform and aims to support environmental and mental health awareness. It operated using sole proprietorship to let everyone work latest: John Benedict Young II as the Owner, John Eliquiel Jose Austria as the Operations Head, Emjel Mercado as the Marketing Head with Catherine Calixtro as the Marketing Officer and Quality Control Head, Katriel Santos as the Finance Head, and John Matthew Hilbero as the Human Resource Head. The market is vast as it is in Digital Marketing. The main competitors of EUNOIA are the 20 groups in the ABM Department. All of the total investment came from EUNOIA's parents and, as of now, is at ₱ 36,000.00. EUNOIA’s expenses amounted to ₱ 71,776.50 as of March 15, 2021.

Key Words: EUNOIA; jute; Beautiful Thinking; Peace of Mind; Calla Lily

I. BUSINESS REGISTRATION AND ORGANIZATION



Figure 1. Organizational Chart of EUNOIA

EUNOIA registered the logo of the business into the Intellectual Property Office of the Philippines (IPOPHL). It had the following benefits from the business trademark; protect the identity of

the business in the marketplace and give the owners of the business the right to sue others that may use or exploit the business’s logo. EUNOIA secured permits such as the Mayor’s permit, the Bureau of Internal Revenue (BIR) permit, and the Department of Trade and Industry (DTI) permit, respectively.

The Business Permit allowed the entrepreneurs to operate in the City of Tacloban where the business owner lives as agreed by all of the managers to ensure to have strict compliance with the policies, laws, ordinances, rules, and regulations imposed in the city.

EUNOIA is registered as a sole proprietorship that is owned and run by one person. However, the ratio of decisions among all of the six



(6) members of EUNOIA is 1 to 1. Decision-making in EUNOIA is through voting and an agreement of the group across all departments of the business. The business used sole proprietorship as the type of business because it requires everyone to actively participate in the business and not just be an investor.

II. BUSINESS PLAN IMPLEMENTATION

A. Production/Operations

EUNOIA searched for suppliers who are willing to follow the demands of the business group. The jute bag will be held for dispatch to EUNOIA and delivered to all of the business partners. After the arrival of the product, the production manager and the quality control officer will inspect the bag for any issues. If there is no problem, the power bank will now be included in the bag. It will now then be put in the packaging. The two separate products will now go under final quality control and be dispatched for products ready to be delivered. The courier assigned will be the one to deliver directly to the customer.

The business started to operate with a total of 100 products of “Beautiful Thinking” with the help of Birosel Variety Trading. The said product was officially launched in November 2020; however, it already accepted pre-orders in October 2020. The members cooperate with each other in order to have outstanding sales for the first batch of production. All products sold were recorded on its inventory to keep track of the stocks and sales.

Overall, the business had a successful production throughout its operation. The managers sold all of the bags for batch one on the 15th of December 2020 and are hopeful to achieve it again for the 2nd batch production of Beautiful Thinking tote bags as the scheduled business closure on April 30, 2021, is fast approaching.

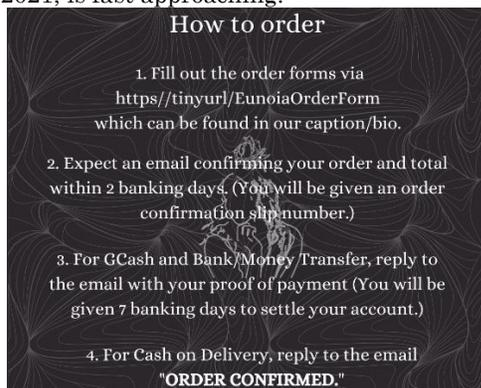

Figure 2. Customer Order Guide for a smooth order

process.

Eunoia maximizes the benefits of Digital Platforms, which contain the resources and products of the business where the customers could order Eunoia’s products. Once ordered, it will need a confirmation about the payment. Eunoia will check if there is an availability of stock of the product before the delivery. Eunoia will now send an email about the details of the delivery to assure that the product is ready to be received by the customer. Lastly, EUNOIA will deliver the product either meet up or delivery.

B. Marketing



Figure 3. EUNOIA Team with Beautiful Thinking.

The business provided its customers with unique and high-quality 3-in-1 Tote Bags that may include accessories that can be useful, especially amidst the pandemic. The business group sold tote bags that have artworks printed on them. In addition, the artwork present in the bag is also notable since it is related to EUNOIA’s advocacy: mental health awareness, made by EUNOIA’s marketing manager.

EUNOIA also aims to raise environmental awareness. Jute Fiber is known to be low density, low cost, no health risk, easy availability, more economical energy requirement, renewability, high specific modulus, durable, and 100 % biodegradable (Gon et al., 2012). It can be a more environmentally friendly alternative to the commonly used canvas as a textile for tote bags.



Figure 4. Jute Fabric is both Waterproof and Fire Retardant.

Furthermore, these bags can be bought with accessories such as the Power Bank and Alcohol Spray Mist for customers with agendas outside amidst the pandemic. Although the Quality Control Manager made sure that each of the accessories is safe, it is the responsibility of the business to ensure that there are safety precautions. Nevertheless, EUNOIA's managers checked the quality for any possible defects. The safety features included are the use of the Jute Fabric, which is a fire retardant and waterproof material (Gon et al., 2012).

The tote bag has pockets wherein gadgets such as books, notebooks, pad papers, ball pens, laptops, mobile phones, and other electronic devices may be placed. EUNOIA's products have multipurpose use, allowing consumers to use them in several ways, such as a backpack, tote bag, handbag, or sling bag.

EUNOIA has launched three (3) designs of the 3-in-1 Tote Bag and one (1) design of the business's Product Diversification, the Jute Pouch. The first design released was "Beautiful Thinking"; it shows EUNOIA's desire to help their customers attain Beautiful Thinking by spreading positivity and awareness.

The second design of the 3-in-1 Tote Bag is "Peace of Mind"; EUNOIA wanted to help ease the minds of its customers and reassure them. The business wanted to help create a safe space and show that they are not alone. The third design of the

3-in-1 Tote Bag is "Calla Lily". It comes from the name of a flower that symbolizes Magnificence and Beauty. EUNOIA wishes to show the Magnificence and Beauty in life.



Figure 5. EUNOIA's three designs: Beautiful Thinking, Peace of Mind, and Calla Lily.

Product Unit Price

- Beautiful Thinking (Bag) - ₱ 518.00
- Beautiful Thinking (Bag and Powerbank) - ₱ 618.00
- Beautiful Think (Bag and Alcohol Spray Mist) - ₱ 678.00
- Peace of Mind (Bag) - ₱ 518.00
- Peace of Mind (Bag and Powerbank) - ₱ 618.00
- Peace of Mind (Bag and Alcohol Spray Mist) - ₱ 678.00
- Calla Lily (Pouch) - ₱ 99.00
- Power Bank - ₱ 100.00
- Alcohol Spray Mist - ₱ 150.00

Figure 6. EUNOIA's Prices.

For the advertising and promotion of EUNOIA's products, the business group utilized social media platforms Facebook and Instagram. EUNOIA also did photoshoots to promote the flagship product, and customer appreciation posts were also made.

C. Human Resources

EUNOIA is composed of six members namely **John Benedict Young II, Katriel Santos, Eliquiel Austria, John Matthew Hilbero, Emjel Mercado, and Catherine Calixtro**. Mr. Young is the owner of EUNOIA; he is responsible for the growth and the overall decisions of the business. He has the authority to make strategic decisions and oversee the operations of each department. Mr. Austria, the Operations Head, is tasked to control the process of



production and oversee the day-to-day operations of the business. Ms. Santos, the Finance Head, to monitor financial activities of EUNOIA. Mr. Mercado, the Marketing Head and the CSR Staff, is responsible for managing the marketing campaigns of the business. Ms. Calixtro, the Marketing Officer, Quality Control Head, and the Corporate Social Responsibility Manager, is tasked with assisting the Marketing Manager in creating the publication materials and managing the social media platforms to entice more customers as well as ensuring that the quality of the product is maintained or improved. She, along with the CSR Staff, is also responsible for communicating with Philippine Mental Health about our advocacies. Mr. Hilbero, the Human Resources Head and the CSR Staff, is responsible for the compensation and benefits of each employee as well as the growth, training, and development of each department. For the compensation packages, the members have decided not to compensate themselves because, after closing of the business, the cash on hand as well as the assets of EUNOIA will be divided equally.

D. Finance

The Finance Manager is in charge of the preparation of the financial statement and the budgeting of the business. Katriel Santos, as the Finance Head, is the overall in charge of the EUNOIA's financial endeavor as she worked closely with John Benedict Young II. EUNOIA pitched a total of P 36,000.00, which is equivalent to P 6,000.00 each as their initial start-up capital. Furthermore, the net income in October 2020 amounted to P 1,659.50 while (P 8, 037.50) in November 2020 as the business's expenses to purchase enough inventories zoomed up. Also, in December 2020, EUNOIA's net income was P 3,981.00, P 1,562.90 in January 2021, P 1,499.45 from February 2021, and P 2,884.00 in March 2021. It resulted in P 3,549.35 for the total net income from October 2020 - March 2021.

The cash and cash equivalents of EUNOIA are now at P 45,230.50, and the inventory stands at P 25,368.00; so, as a result, the Total Current Assets of the business is P 70,598.50. On the one hand, EUNOIA's liabilities amounted to P 9,477.00. Besides, EUNOIA's Total sales as of March 15, 2021, is at P 72,166.00. In contrast, the Total Expenses amounting to P 71, 776.50, so the business partners have a Total Revenue of P 389.00. The Total Value of EUNOIA in Assets is P 25,368.00. When adding the Total Sales and the Total Assets, EUNOIA may acquire a potential sales of P 97,534.00. On the contrary, the Break-Even Point is computed around P48,962.00 in terms of peso and 94 pcs. of tote bags.

EUNOIA aims to have a gross profit of P 36,000.00 on or before April 30, 2021. Nevertheless, the average Margin of Profit per unit is at P 1,105.55 or 43%.

Total Sales: ₱ 72, 166.00
 Total Expenses: ₱ 71, 776.50
 Total Revenue: ₱ 389.00
 Initial Capital: P 36,000.00
 Sales + Assets = P 72, 166 + P 25,368.00 = **₱ 97, 534.00**
 Unit Cost: P 385.00
 $36, 000.00 \div 385.00 = 93.51$ units
 BREAK EVEN (In Units): 94 pcs. of tote bags
 $94 \times 518 =$ P 48, 962.00
 BREAK EVEN (In Peso): P 48, 962.00
 Total Assets / Inventories as of March 2021
₱ 25, 368.00

Figure 7. The Computation of EUNOIA's Break Even.
 $3, 549.3567, 049.15 \times 100 = 5.29\%$

Figure 8. The Computation of EUNOIA's Return of Investment.

III. PRODUCT DIVERSIFICATION



CALLA LILY



Figure 9. EUNOIA's Calla Lily.

EUNOIA launched a new product called Calla Lily, which is the same product line as the flagship product. It is a Pouch made of the same Jute Fabric materials from the Tote Bags made. It can be used for the storage of many things such as mobile devices and other essentials. To add, a drawing of the flower is placed in the middle of the pouch. The Calla Lily flower signifies Magnificence and Beauty. It is introduced through a strategic price of ₱ 99.00. The business wanted the customers to know that each one of them is Magnificent and Beautiful in their own way.

IV. FUTURE PLANS

EUNOIA decided to close the business on April 30, 2021 as the outlook of the business in terms of trademarks, patents, copyrights, licenses, and



royalties that it will undertake as it will continue A.Y. 2020 - 2021. However, if the team wishes to continue, they may do so.

EUNOIA would like to provide a larger variety of products and create more artworks that cater to its advocacy, Mental Health Awareness, as well as to collaborate with more organizations and create partnerships. If the situation allows it, the business would like to engage in fundraising activities that support the advocacy as well as sell in physical stores instead of relying mostly on its Digital Platforms.

As agreed upon, these became part of the property of EUNOIA. The managers of EUNOIA may sign a Memorandum of Understanding to make a legal agreement on the terms and conditions for continuing the business after April 30, 2021.

V. ACKNOWLEDGEMENT

EUNOIA would like to thank their parents, who provided them with all their monetary needs, and friends for their utmost support.

EUNOIA would like to thank the organization, Philippine Mental Health Association, Inc., and the supplier, Birosel Variety Trading, for their cooperation and help.

The business was able to perform well with the constant help and support of our dearest research adviser, Ms. Marife Magsino, together with the other research mentors: Ms. Emmielyn Bardiano, Ms. Windie Odoño, and Ms. Nerisse Estrada.

Last, EUNOIA would like to thank each and every team member. Without everyone's effort and hard work, EUNOIA would not have been able to succeed and get this far.

Thank you for joining EUNOIA in the Journey to Beautiful Thinking, the members deeply appreciate all the love and support that has been given to them!

VI. REFERENCES

- Gon, D., Das, K., Paul, P., & Maity, S. (2013). Jute Composites As Wood Substitute. *International Journal of Textile Science*, 1, (6), 84-93. <https://doi.org/10.5923/j.textile.20120106.05>.
- Pike, M. (2015). *Ethical English: Teaching and Learning in English as Spiritual, Moral, and Religious Education*. London: Bloomsbury Publishing Pic.
- Smit, E. (2013). *Millennials And Mental Health: Post Secondary Students Feel Anxiety, Have Suicidal*

Thoughts Survey Says. 2.
<https://www.huisartsenamsterdam.nl/wp-content/uploads/2015/08/Research-report-E.-Smit-17-07-2015.pdf>.



FILO: For and by the Filipinos



Alonzo Joaquin T. Barretto, Ofelia Gasangue, Aaron P. Maglanque,
and Jami Chriseline B. Romulo
De La Salle University Integrated School, Biñan City, Laguna

Generie M. Manuel, *Research Adviser*
De La Salle University Integrated School, Biñan City, Laguna

Executive Summary: Striving to uplift the local artistry and replace plastic products in the home and decor industry through the use of sustainable alternatives, FILO, a Laguna-based home and decor business, officially launched in November 2020 through social media. The venture has adopted Bicol artisan-made coir and abaca animal planters. The business exists and envisions fostering a sustainable future through instilling environmental awareness and promoting Philippine indigenous materials and local artisans to the market. The sole proprietorship, operating under the leadership of Mr. Alonzo Barretto with its key management personnel: Ms. Ofelia Gasangue, Mr. Aaron Maglanque, and Ms. Jami Romulo, is armed with their business skills, adaptability, and dynamics; the team has contributed significantly to ensuring the venture's effective and efficient business operations.

Throughout the years, an increasing trend is seen in the sales of the gardening industry. Despite this increase, major established competitors, such as Ennoble and Fig & Vine, have dominated the market with their high-priced, wide array of products. However, FILO's edge remains its mission and pricing strategy. It significantly targets plant enthusiasts, individuals leading a sustainable lifestyle, or gardening entrants with its considerably lower pricing scheme.

The initial capital of the business amounted to PHP 35,750.00, inclusive of product development and operating expenses, which the partner-entrepreneur equally contributed. The business intends to divide the income equally to the investors when the venture desists to exist.

Key Words: sustainable alternatives; Philippine indigenous materials; Bicol artisans; coir and abaca animal planters; coconut

I. BUSINESS REGISTRATION AND ORGANIZATION

Recognizing the need to uplift the Philippines' craft industry and enable accessibility of Bicol artisan-made products to the market, FILO

was born to its existence. It is a home and decor business in Laguna promoting locally sourced products. The business valued integrity, empathy, and satisfaction in both its stakeholders and management. Moreover, FILO did not solely value profit but, moreover, the holistic growth and improvement of the environment and its



stakeholders throughout its operations. Furthermore, FILO ensured it took steps to gradually become an industry leader whilst promoting the culture of the Philippines and the craftsmanship of local artisans.



Figure 1. Organizational Chart

The venture is headed by the sole proprietor, Mr. Alonzo Joaquin T. Barretto. Such structure was decided upon as sole proprietorship that allowed for straightforward establishment and performance of business decisions. Furthermore, it allowed straightforward banking, easier processes, and fewer requirements for legal documents than corporations and other forms of ownership (University of Richmond, 2021). The following are the managers of FILO:

Mr. Alonzo Joaquin T. Barretto

Mr. Alonzo Joaquin T. Barretto, the Owner and the Administrative Manager of FILO, led and distributed the business operation tasks and ensured the punctuality of overall operations.

Ms. Ofelia Gasangue

Ms. Ofelia Gasangue, the Finance and Marketing Manager, strategically planned and monitored the cash flows and effectively implemented various marketing strategies.

Mr. Aaron P. Maglanque

Mr. Aaron P. Maglanque, the Sales and Logistics Manager of FILO, directed and supervised sales management and evaluated the effectiveness of sales strategies. Furthermore, as the Logistics Manager, he led the team in organizing and updating the number of supplies in FILO's inventory.

Ms. Jami Chriseline B. Romulo

Ms. Jami Chriseline B. Romulo, the Operations and Business Development Manager, maximized business operating capabilities and identified opportunities to develop business growth.



Figure 3. Combination Mark

The business's trade name, "FILO", and its trademark were inspired by the Greek word "Filosofia" meaning, love for wisdom. "FILO" also refers to Filipino Local Products. The business has aimed to spread environmental awareness through sustainable practices and offer eco-friendly products made locally by Filipinos for Filipinos. Green, often associated with nature, health, and tranquility (Meola, 2005), is the base color of the logo. With the heart that symbolizes love, and the leaf that symbolizes nature, the alternate mark depicts the business' love and care for the environment. Meanwhile, edges in the word mark were altered to mimic the pointed edges of leaves, emphasizing agriculture. Overall, the logo represents the organic and natural aura that FILO wants to give off.

II. BUSINESS PLAN IMPLEMENTATION

II.A. Production

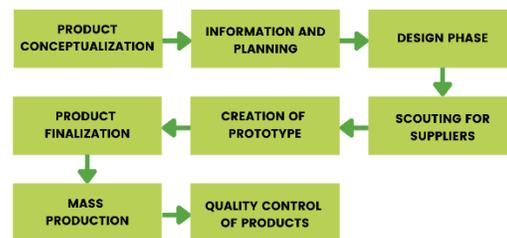

Figure 3. FILO's Product Development Process

The first stages of FILO's product development involved identifying the bright idea from the management's analysis of current market conditions and trends and determining the venture's social value to bring forth to our stakeholders. The following are the four factors that immensely contributed to the establishment of FILO's bright idea:

- a. The need to uplift the Philippine's culture and craft industry, the business decided to use indigenous materials in the country, namely, coconuts and abaca



- b. The expertise of local artisans, thus showcasing their ability through making a novelty product
- c. Curation of sustainable products that aid in alleviating plastic pollution because of plastics' alarming presence in both terrestrial and marine environments (Fernandez, 2020; Global Alliance for Incinerator Alternatives [GAIA], 2019)
- d. Proliferation of gardening in the Philippines (Mirafior, 2020)

The design phase started through an online survey and a focused group discussion. Through such measures, the business solidified its flagship product decision. The following stage, scouting for our suppliers, happened simultaneously with the design phase. Eventually, they contacted local artisans in Naga City, Bicol, for the planters. Consequently, the packaging, a canvas string pouch, was produced in Binangonan, Rizal. After a series of thorough discussions and deliberation, the creation of the prototype was carried out. Upon receiving the prototype and successfully defending the Business Concept, the team further examined the quality and marketability of the planters. With this, necessary changes were made: Wes the Whale is changed from black to blue to provide a variety of choices from the designs and to fit each animal accordingly. This was coordinated with the suppliers, and mass production took place.



Figure 4. Final Flagship Products of FILO

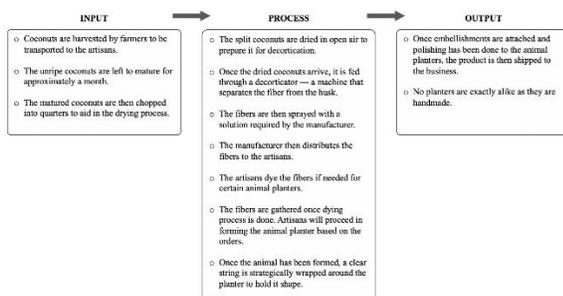

Figure 5. Input-Process-Output Model of FILO's Animal Planters

The Input-Process-Output Model shows the process of producing FILO's coir animal planters. The input exhibits the artisans' acquisition of raw materials, the coconut fibers, from Catanduanes and Albay. It starts with the harvest of coconuts then being dried in order to extract the fiber from the husk through decortication. Treatment is done accordingly before distributing to the artisans for planter production. In the process, the artisans dye the fibers accordingly: blue, black, and beige. Consequently, they start to form the planters with the coconut fibers in an abaca framework. Afterward, it is embellished and bound by a nylon string for stability. Once polishing is finished, it is now prepared for shipment and distribution to FILO. No two pieces are exactly alike in FILO's Animal Planter Pals as these are artisan-made. Lastly, disinfection of the products took place after acquisition. Consequently, quality and inventory control was executed throughout operations.

II.B. Marketing

FILO offered Bicol-artisan crafted animal planters made of coir and abaca. Each planter, regardless of variation, retails for PHP 449.00, as it took into account the three C's of brand development: company (in this case, the business), customers, and competitors. It was directed towards providing the best deals and offers to all stakeholders, especially their consumers, to accomplish their value propositions and to secure profitability.

The coir was the dominant material of the planter and abaca was used as a framework, while the product was bounded by clear nylon strings to strengthen and retain its shape. Three variations are Ely the Elephant, Oli the Corgi, and Wes the Whale. The product comes with a reusable 17x14 inch canvas pouch.



Figure 6. Oli the Corgi



Figure 7. *Ely the Elephant*



Figure 8. *Wes the Whale*

The business mainly operated in Barangay Don Jose, Sta. Rosa City, Laguna; however, it will not have a physical store due to the COVID-19 situation. Fortunately, the utilization of social media platforms was done to conduct marketing operations. FILO also utilized direct marketing strategies wherein the management team personally reached out to target customers within their area — family, friends, classmates, and neighbors — and conducted personal selling.

Direct channels consisted of FILO's management who were in charge of product deliveries. Areas covered were within Laguna: Biñan, Sta. Rosa, San Pedro, and Calamba. Furthermore, third-party logistics included Lalamove, Grab, LBC, and J&T Express. FILO offered payment options including cash through meet-ups, GCash, PayMaya, and Security Bank bank transfers.



Figure 9. *FILO's Logistics Team*

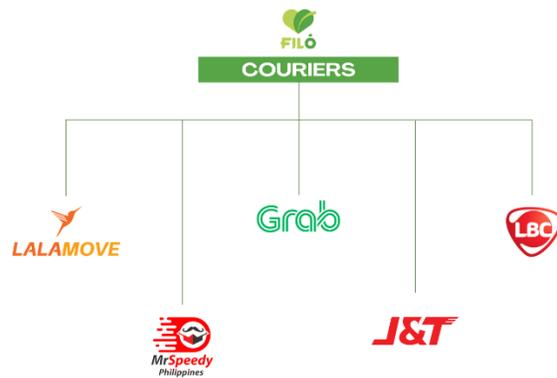

Figure 10. *Third-Party Logistics Couriers*

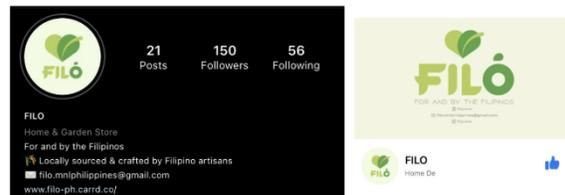

Figure 11. *Instagram and Facebook pages*



Figure 12. *Carrd.co website*



Figure 13. *Sample Publications*

FILO has drawn inspiration from the perseverance of Filipinos to turn resources and talents into profitable products and services. In the same light, it sought to honor the hands, minds, and hearts behind the growing success of Filipino,



specifically Bicolano, artisanship. The products and promotions of the business have reflected FILO's support of the local art scene of the country, specifically, the artisans. The payment of the planters for retail directly went to the artisans; thus, contributing to their craftsmanship and daily lives. Moreover, the raw materials they used, coir and abaca, to produce their crafts were sourced locally. With the materials of the planters being biodegradable, FILO also has recognized the urgent need to take action as the world and humanity continue to battle climate change. To reach the market and promote its products, the venture uses a variety of social media platforms: Facebook, Instagram, Messenger (@filo.mnl), and Carrd.co. The marketing manager ensured weekly posts on Facebook And Instagram to capitalize on the algorithm of both social media platforms.

II.C. Human Resource

As the business expands, there must be an established form of commission for the respective managers and employees. If the company seeks to secure its own production line, the only change that will occur in its cash flow would be the maintenance of the decorticating machine based on the cash flow of the Philippine Coconut Authority (n.d).

As a result, the business must hire and train employees capable of maintaining the decorticating machine whilst hiring artisans who can consistently create quality animal planters if the business wants to operate smoothly in the future. The hourly rate of employees is PHP 50.00, and a quota on the production of animal planters for the artisans shall apply. They will be required to make 12 animal planters per working day, and they will get paid PHP 100.00 per hour. The reason for the quota is that the animal planters cannot be mass-produced since artisans are creating them. The reason for increasing the wage of these artisans by PHP 50.00 is due to the level of skill required to create the planters.

Table 1. Average Salary of the Managers

Average Per Year	Manager
PHP 140,000	Business Owner
PHP 170,000	Business Development
PHP 200,000	Finance
PHP 160,000	Human Resource
PHP 180,000	Logistics Manager
PHP 190,000	Marketing
PHP 190,000	Operations

Table X presents the salaries of the managerial positions of FILO once the business has expanded. These salaries were based on the financial profiles provided by PayScale (2021),

where the community provides salary profiles for the respective managerial positions. The salaries range from PHP 140,000.00 to PHP 200,000.00 to represent a more accurate depiction of a small business.

II.D. Finance

To establish the business, Mr. Barretto, together with the business managers—Mr. Maglanque, Ms. Romulo, and Ms. Gasangue—equally invested PHP 8,937.50. It included the costs of 100 animal planters, string pouch bags, thank you cards, and operating expenses. Altogether, the business initially invested an amount of PHP 35,750.00.

For 2020, FILO's total sales was PHP 32,777.00. Continuing the operations in 2021, the total sales from January until April amounted to PHP 21,468.00. Overall, total sales for the duration of the operations amounted to PHP 54,245.00.

The venture's total income for 2020 amounted to PHP 8,589.70. In 2021, PHP 5,208.06 was earned. In total, income throughout business operations amounted to PHP 13,797.76.

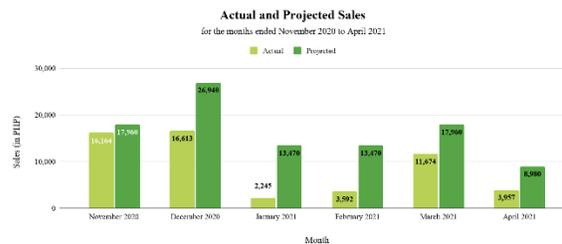

Figure 14. Actual and Projected Sales for the months ended November 2020 to April 2021

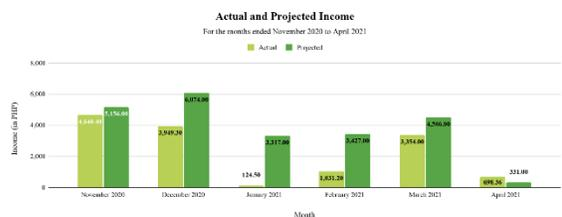

Figure 15. Actual and Projected Income for the months ended November 2020 to April 2021

III. PRODUCT DIVERSIFICATION

A business diversifies its product line to cater to a greater market. Strategic products and services may greatly contribute to the venture's brand awareness, overall market position, and profitability (Le, 2019); thus, FILO offered plants as



its product diversification. It did not only complement the flagship product but also aided in becoming a coping mechanism for people. Moreover, it encourages consumers to become more environmentally conscious.

The first releases were the Lucky Bamboo Plant and Bunny Ears Cactus. The second release included succulents: Rose Cabbage and Black Prince.



Figure 16. Plants (from left to right: bunny ears cactus, lucky bamboo, black prince, rose cabbage)

IV. FUTURE PLANS

Future plans of the business include expansion of the variation of its flagship product and development of coconut-derived products.

FILO is committed to pursuing its Corporate Social Responsibility program, HAKBANG: Tungo sa Masaganang Kinabukasan, which aims to give back to the environment and the Filipinos through engaging in paper recycling and donation drives. For Our Farmers (For Our Farmers, n.d.), a non-profit organization that helps uplift local farmers and fisherfolks, shall be the beneficiary.

In the meantime, the business is planning to halt operations once given consent. The main driving force of the decision is the managers' transition into tertiary education. Fortunately, this is yet to be finalized as the business is open to opportunities. If it chooses to dissolve, it would be to change the organizational structure from sole proprietorship to partnership. To preserve and protect Intellectual Property, the business shall be legally registered.

VI. REFERENCES/APPENDICES

Fernandez, H. (2020). *Why plastic-clogged Philippines must face up to dearth of waste disposal and recycling*. Eco-Business. <https://www.eco-business.com/news/why-plastic-clogged-philippines-must-face-up-to-dearth-of-waste-disposal-and-recycling/>

For our Farmers. (n.d.). *About Us*. <https://forourfarmers.com/about>

Global Alliance for Incinerator Alternatives. (2019). *Plastics Exposed: How Waste Assessments and Brand Audits are Helping Philippine Cities Fight Plastic Pollution*. <https://www.no-burn.org/wp-content/uploads/PlasticsExposed-3.pdf>

Le, H. (2019). Literature Review on Diversification Strategy, Enterprise Core Competence and Enterprise Performance. *American Journal of Industrial and Business Management*, 9, 91-108. <https://doi.org/10.4236/ajibm.2019.91008>

Meola, K. (2005). The psychology of color. *A Journal of Academic Writing*, 3 41-44.

Miraflor, M. (2020, August 17). *Seller 'plantitos' and 'plantitas' may soon need government accreditation*. <https://mb.com.ph/2020/08/17/seller-plantitos-and-plantitas-may-soon-need-govt-accreditation/>

PayScale. Salary Comparison, Salary Survey, Search Wages. PayScale. (2021). <https://www.payscale.com/>.

Philippine Coconut Authority (n.d). *Coco coir/fiber production*. http://www.pca.da.gov.ph/pdf/techno/coir_fiber_pdf

University of Richmond (2021). *Sole Proprietorships*. <https://law.richmond.edu/academics/clinics-skills/in-house/ip-clinic/pdf/business-sole-proprietorship.pdf>.



BEYOND CLOTHING



Pia Marie A. Andrade, Carl Daniel P. Cedro, Jose Lorenzo Pablo B. Crespo, Stephanie Louise D. Goñe, Nyanna Dominique S. Mallari, and Lyan M. Zapanta
De La Salle University Integrated School, Biñan City, Laguna

Ms. Marife M. Magsino, *Research Adviser*
De La Salle University Integrated School, Biñan City, Laguna

Executive Summary: BEYOND CLOTHING, a sole proprietorship business formed in February 2020 by Pia Andrade, officially started operations in November 2020 with the mission to provide athletic apparel to Generation Y and Generation Z residing in Region IV-A as they want to help promote healthy lifestyles. BEYOND CLOTHING offered athletic Coolpass fabric shirts priced at Php 400.00 which are available in five sizes and four colors as their flagship product. They diversified into athletic Taslan shorts priced at Php 349.00, which are available in two sizes and two colors. BEYOND CLOTHING entered the athletic apparel market using the market penetration pricing strategy. BEYOND CLOTHING used digital marketing in advertising their products. Both their flagship product and their product diversification, featuring designs made and owned by BEYOND CLOTHING, are comfortable and durable. The strengths of BEYOND CLOTHING that set it apart from its competitors are its products' durability and features, their meet-up and delivery services, their efficient teamwork, their good supplier relationship and inventory management, and their effective advertising. A total of 120 shirts were produced by the business with a start-up capital of Php 30,000.00 sourced from the owner and the managers. As their break-even was reached, BEYOND CLOTHING allocated Php 3,800.00 for their product diversification. BEYOND CLOTHING will continue its operations after graduating at the end of the academic year.

Key Words: sole proprietorship; athletic apparel; shirts; shorts; digital marketing

I. BUSINESS REGISTRATION AND ORGANIZATION

BEYOND CLOTHING was able to accomplish three business registrations in the course subject Practical Research 3 for their business simulation's operations. They registered the business operations under the city of Biñan and the business name with the Department of Trade and Industry. They were also able to complete Form 1901 of the Bureau of Internal Revenue.





II. BUSINESS PLAN IMPLEMENTATION

II.A. Production/Operations

BEYOND CLOTHING'S flagship product and product diversification suppliers are SMILEE APPAREL and ONENG'S CLOTHING, respectively. After being notified by the supplier that batch orders are ready for pick-up, the batch of shirts is picked up from the textile supplier's facilities. On the other hand, stocks for shorts are directly delivered to Operation Manager's residence via courier service.

BEYOND CLOTHING's suppliers for the zip-lock packaging, ZIPLOCK GRAPHICS, and box packaging, CAROL'S SHOP, are contacted through Facebook Messenger and Shopee, respectively. All transactions and payments were made online. After the delivery for the packaging is received by the Operations Officer, the group members initiate and schedule the execution of the packaging of products for both the shirts and shorts, commonly held in the Quality Control Officer's residence. All inventories are stored in the Quality Control Officer's residence for safekeeping. Whenever a stock is taken out, the Operations Officer immediately takes note of this. Members meet up on or before the day of the scheduled delivery.

When an order is placed through the Order Form, BEYOND CLOTHING's operations take note of these orders while waiting for the customer's confirmation. Once the verification is received, BEYOND CLOTHING begins to process and gather said orders. They would then be scheduling a meet-up or a delivery date with the customer. BEYOND CLOTHING's covered areas include Calamba, Cabuyao, Santa Rosa, and Biñan. BEYOND CLOTHING offered different payment modes which included cash on deliveries (COD), GCash, and online bank deposits.



Figure 3. BEYOND CLOTHING'S Step-by-step Ordering Process

II.B. Marketing

BEYOND CLOTHING specializes in both athletic shirts and athletic shorts. BEYOND CLOTHING's products are designed and made from high polyester fabric that exemplifies a minimalist

design—inclusive of the brand's name and logo. On top of that, comfortability and durability are the innermost significant features of the products. BEYOND CLOTHING's 'FLAGSHIP' shirts have four color variants: black, white, jade green, and navy blue. BEYOND CLOTHING has decided to release athletic shorts as its product diversification as these are in the same product line as the Flagship Product. Produced the newly-released products from high-tech Taslan fabric, which exemplifies its durability. The athletic shorts have two color variants: black and red.

The business used the market penetration pricing strategy to attract and penetrate its target consumers. BEYOND CLOTHING's 'FLAGSHIP' shirts cost Php 400.00, and the athletic shorts cost Php 349.00. With a market penetration strategy, the business was competent to penetrate customers due to the lower price.

Due to the current physical constraints, BEYOND CLOTHING adjusted its marketing channels to maximize safety and avoid inconvenience among its target market. The business utilized social media platforms wherein consumers can access BEYOND CLOTHING's products. With the digital avenues used, there was high availability of market penetration.

BEYOND CLOTHING utilized the digital marketing approach to enhance its promotions. The products' visibility on the digital platforms progressively helped the business increase sales and market share. BEYOND CLOTHING used ambassadors to represent the business's brand and as well as establish online presence and brand awareness.



Figure 4. BEYOND CLOTHING's Marketing Publications for the FLAGSHIP Shirts



Figure 5. BEYOND CLOTHING's Marketing Publications for the Taslan Shorts Product Diversification



3RD DLSU SENIOR HIGH SCHOOL RESEARCH CONGRESS

BUSINESS CONCEPT BAZAAR



Figure 6. *BEYOND CLOTHING's Marketing Publications for the Brand Ambassador*

II.C. Human Resources

All suppliers and ambassadors that have been mentioned in the production operation, have signed a contract of agreement with BEYOND CLOTHING to ensure that the guidelines are being followed. All rules implemented from the agreement undergo deliberation by all the group members. As a result, good teamwork, quality service performance, and progressive development of skill sets during the business production.



We are **BEYOND CLOTHING**, ABM students from the De La Salle University - Laguna Campus. Our brand focuses on sportswear shirts and we are hopeful to extend our line soon. **BEYOND CLOTHING** will operate starting on SEPTEMBER 2020 until APRIL 2021. As we start our business, we are looking for suppliers who can be our key partners for our business.

BEYOND CLOTHING will engage in selling athletic shirts, the material of the product being polyester. The brand prioritizes comfort, breathability, affordability, and durability. We are pleased to let you know that we have chosen you as one of our key partners, as one of the suppliers of **BEYOND CLOTHING**, as we operate our business starting on SEPTEMBER 2020 until APRIL 2021.

This Supply Sales Agreement is made on SEPTEMBER 2020 between **BEYOND CLOTHING**, business handled by students in De La Salle University - Laguna Campus, business with its principal place at BINAY, LAGUNA, and **ZIPLOCK GRAPHICS**, with its principal place of business at MEYACAUAYAN, BULACAN.

The **ZIPLOCK GRAPHICS**, as an external supplier of the packaging of **BEYOND CLOTHING**, have agreed to the following:

1. **ZIPLOCK GRAPHICS** will supply and **BEYOND CLOTHING** will purchase the **ZIPLOCKS PRODUCTS** in accordance with the terms of this agreement.
2. **Orders**
 - 2.1. **ZIPLOCK GRAPHICS** will submit all orders of Products to the given address by **BEYOND CLOTHING** in the introduction of this agreement.
 - 2.2. **Accepting, Modifying, and Rejecting Purchase Orders**
 - a. **Demond Acceptance.** If **ZIPLOCK GRAPHICS** fails to notify **BEYOND CLOTHING** regarding its acceptance, rejection, or proposed modification, meaning, **ZIPLOCK GRAPHICS** accepted the Purchase Order.
 - 2.3. **Cancelling Purchase Orders.** **BEYOND CLOTHING** may cancel part or all of its purchase order seven (7) Business Days before the delivery Date.
3. **Delivery.** **ZIPLOCK GRAPHICS** shall deliver the Products to **BEYOND CLOTHING** on the given date, at the stated address in the introduction of this agreement, using any delivery method.

4. **Acceptance**
 - 4.1. **Acceptance of Delivery.** The delivery of **ZIPLOCK GRAPHICS** will be considered complete if:
 - a. **BEYOND CLOTHING** is satisfied with the Products delivered.
 - b. **BEYOND CLOTHING** notifies **ZIPLOCK GRAPHICS** through online platform (Messenger) that it has accepted the Product.
5. **Pricing**
 - 5.1. **Updated Price List.** **ZIPLOCK GRAPHICS** will submit its updated price list to **BEYOND CLOTHING** within the range of the operations of **BEYOND CLOTHING** stated in the introduction of this agreement.
 - 5.2. **Purchase Price.** **BEYOND CLOTHING** will pay the Purchase Price to **ZIPLOCK GRAPHICS**:
 - a. In full amount.
 - b. Through money transfer with the use of online banking.
6. **Confidentiality**
 - 6.1. **Confidentiality Obligation.** **ZIPLOCK GRAPHICS** must hold all Confidential Information given by **BEYOND CLOTHING** particularly the designs and logo of the business.
7. **General Provisions**
 - 7.1. **Amendment.** This agreement can only be amended by a signature by both parties.
 - 7.2. **Relationship of the Parties**
 - a. **No Relationship.** There is no special relationship between **BEYOND CLOTHING** and **ZIPLOCK GRAPHICS** in this agreement, such as partnership, joint venture, or employee/employer relationship.
 - b. Neither the **ZIPLOCK GRAPHICS**, as an external supplier, nor **BEYOND CLOTHING**, are **not allowed to back out** until the said contract is terminated.
 - 7.3. **Counterparts**
 - a. **Signed in Counterparts.** This agreement may be signed in any number of counterparts
 - b. **All Counterparts Original.** Each counterpart is an original and is/are part of **BEYOND CLOTHING** and **ZIPLOCK GRAPHICS**.
 - c. **Counterparts Form One Document.** Together, all counterparts form one single document.

Figure 7. *BEYOND CLOTHING's Contract of Agreement (SUPPLIER)*

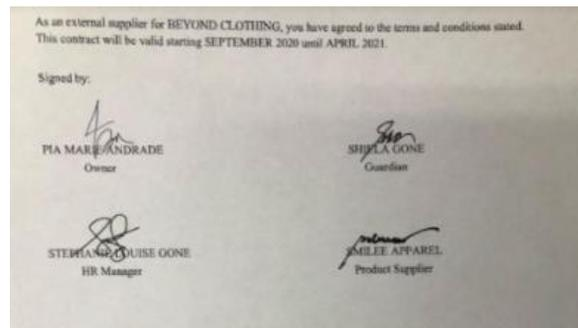

Figure 8. *SMILEE APPAREL*



Figure 9. *ZIPLOCK GRAPHICS*



3RD DLSU SENIOR HIGH SCHOOL RESEARCH CONGRESS

2020-2021

BUSINESS CONCEPT BAZAAR

BEYOND

CLOTHING

Greetings,

We are BEYOND CLOTHING, ABM students from the De La Salle University - Laguna Campus. Our brand focuses on sportswear shirts, and we are hopeful to extend our line soon. BEYOND CLOTHING will engage in selling athletic shirts, the material of the product being polyester. The brand prioritizes comfort, breathability, affordability, and durability. We are pleased to let you know that we have chosen you as one of our brand ambassadors, as we operate our business starting on OCTOBER 2020 until APRIL 2021.

Being a brand ambassador includes receiving receivables from BEYOND CLOTHING; the ambassador must deliver the expected deliverables agreed upon by us and by the ambassador. As one of the social media influencers who, we know, love to maintain their body fit and healthy, it would be highly appreciated if you are willing to collaborate with us.

The Ambassador Agreement made on OCTOBER 2020 between BEYOND CLOTHING, business handled by students in De La Salle University - Laguna Campus, and Erich Goñe, ambassador of BEYOND CLOTHING.

As an AMBASSADOR of BEYOND CLOTHING, you have agreed to the following:

1. The ambassador will be receiving one BEYOND CLOTHING shirt of their own choosing, free of charge, for every release of BEYOND CLOTHING.
2. The ambassador must advertise the product on their social media accounts (with the packaging and while wearing the shirt).
3. The ambassador will have to share BEYOND's posts on their social media accounts.
4. The ambassador must not entertain any other businesses in DLSU.
5. BEYOND CLOTHING will hand over the free shirt earlier before the launch for the photoshoot.
6. The ambassador is free to post anything related to the business as long as it has approval from BEYOND CLOTHING.

Figure 10. BEYOND CLOTHING's Contract of Agreement (AMBASSADOR)

Furthermore, BEYOND CLOTHING will acknowledge you as the ambassador and will introduce you by posting your picture on our respective social media accounts. Rest assured that all personal information will ONLY be used in promoting BEYOND CLOTHING.

If you are interested in becoming one of our brand ambassadors, please sign and send it to our email, thisisbeyondclothing@gmail.com on or before October 25, 2020.

As an ambassador for BEYOND CLOTHING, you have agreed to the terms and conditions stated. This agreement will be valid starting OCTOBER 2020 until APRIL 2021.

Sincerely,

BEYOND CLOTHING

Ms. Pia Andrade
Owner

Mr. Lorenzo Lim
Brand Ambassador

Figure 11. Mr. Lorenzo Lim's Agreement

Furthermore, BEYOND CLOTHING will acknowledge you as the ambassador and will introduce you by posting your picture on our respective social media accounts. Rest assured that all personal information will ONLY be used in promoting BEYOND CLOTHING.

If you are interested in becoming one of our brand ambassadors, please sign and send it to our email, thisisbeyondclothing@gmail.com on or before October 25, 2020.

As an ambassador for BEYOND CLOTHING, you have agreed to the terms and conditions stated. This agreement will be valid starting OCTOBER 2020 until APRIL 2021.

Sincerely,

BEYOND CLOTHING

Ms. Pia Andrade
Owner

Erich Goñe's Guardian
Brand Ambassador

Figure 12. Erich Goñe's Parental Consent

Furthermore, BEYOND CLOTHING will acknowledge you as the ambassador and will introduce you by posting your picture on our respective social media accounts. Rest assured that all personal information will ONLY be used in promoting BEYOND CLOTHING.

If you are interested in becoming one of our brand ambassadors, please sign and send it to our email, thisisbeyondclothing@gmail.com on or before October 25, 2020.

As an ambassador for BEYOND CLOTHING, you have agreed to the terms and conditions stated. This agreement will be valid starting OCTOBER 2020 until APRIL 2021.

Sincerely,

BEYOND CLOTHING

Ms. Pia Andrade
Owner

Michelle/Roxanne S. Mallari
Marcus Mallari's Guardian
Brand Ambassador

Figure 13. Marcus Mallari's Parental Consent

There are six members behind BEYOND CLOTHING. Pia Andrade, the owner, has the authority to make strategic decisions and is responsible for all aspects of the business operation. Jose Crespo is the Operations Officer assigned to ensure that the operations systems meet the organization's objectives and goals. Lyan Zapanta, as the Financial Officer, oversees all the financial operations and develops a reliable cash flow of the business. Nyanna Mallari, the Marketing Officer, is assigned to make publication materials and product exposure in social media. As the Quality Control Officer, Carl Cedro is tasked to check the quality of the shirts and seek if there are damages with regards to the packaging and products. Lastly, Stephanie Goñe is the Human Resources Officer, responsible for managing the employee lifecycle and looking for possible suppliers and ambassadors. As per the compensation package for each employee of BEYOND CLOTHING, they will be directly compensated for their work during the operation of the business from October 2020 to April 2021 through salary paid a month after April.

II.D. Finance

The capital of BEYOND CLOTHING has a total amount of Php 30,000, with each member contributing Php 5,000.00. The business' break-even analysis depends on the fixed cost, the selling price, and the variable cost of the flagship product. The variable costs per shirt amounted to Php 224.50 while the fixed costs amounted to Php 28,005.50. The selling price of the flagship product is Php 400. When computed, the break-even points amounted to 160 units of the flagship product they reached last December 31, 2020.

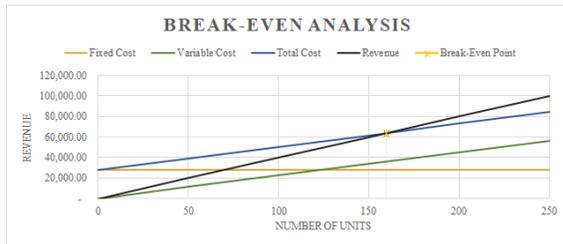

Figure 14. Break-even Point Analysis

Last September 2020, the members had paid their suppliers to prepare for the operation of the business in November. However, in October 2020, the business did not profit as the business has not started operating, resulting in a net loss of Php 30,472.00.

BEYOND CLOTHING	
Income Statement	
For the month ended October 2020	
Net Sales	₱0.00
Cost of Sales	30,072.00
Gross Income	(30,072.00)
Selling and Distribution Expense	400.00
Net Income (Net Loss)	₱ (30,472.00)

Figure 15. October 2020 Income Statement

In November 2020, the BEYOND CLOTHING reached its highest sales, surpassing its projected sale of Php 12,000. Thus, the business has sold 114 shirts that amount to Php 45,600.00 and a remaining five (5) shirts. Moreover, the business has a total of Php 27,358.00 as its cost of sales as members made their decision to purchase 82 shirts for their following collection of shirts. Further, they have a total expense of Php 1,430.00 obtained from the business' selling and distribution expense. Overall, the business has a net income of Php 16,812.00 for November 2020.

BEYOND CLOTHING	
Income Statement	
For the month ended November 2020	
Net Sales	₱ 45,600.00
Cost of Sales	27,358.00
Gross Income	18,242.00
Selling and Distribution Expense	1,430.00
Net Income	₱ 16,812.00

Figure 16. November 2020 Income Statement

In December 2020, BEYOND CLOTHING's net sales decreased by 57%; despite that, they managed to surpass their projected sale of Php 16,000.00. However, they only sold 49 of their shirts for the month, obtaining a Php 19,600.00 sale with a remaining inventory of 26 shirts. Moreover, the business released new colors for their product which costs extra. Thus, they have a cost sale of Php 8,279.00. In addition, the business' total selling and distribution expense for the month is Php 595.00. With that, BEYOND CLOTHING's net income is Php 10,726.00.

BEYOND CLOTHING	
Income Statement	
For the month ended December 2020	
Net Sales	₱ 19,600.00
Cost of Sales	8,279.00
Gross Income	11,321.00
Selling and Distribution Expense	595.00
Net Income	₱ 10,726.00

Figure 17. December 2020 Income Statement



In January 2021, the business failed to reach its projected sale of Php 9,600.00 as they only sold four (4) shirts which garnered a total of Php 1,600.00 as their net sales. Moreover, the business has a total of Php 9,345.00 as their cost, seeing that the business only deducted four (4) shirts from the previous inventory. Also, the business did not have any selling and distribution expenses because of their consumer's preferred mode of delivery. Therefore, BEYOND CLOTHING has a net loss of Php 7,745.00.

BEYOND CLOTHING	
Income Statement	
For the month ended January 2021	
Net Sales	₱1,600.00
Cost of Sales	9,345.00
Gross Income	(7,745.00)
Selling and Distribution Expense	0.00
Net Income (Net Loss)	₱ (7,745.00)

Figure 18. January 2021 Income Statement

In February, the business once more failed to reach its projected sale of Php 35,750.00. BEYOND CLOTHING only sold 12 shirts and two of their product diversification. The discrepancy between the projected and actual sales is because of the failure to account for the market's demand for our product. We only focused on our want to decrease our inventory. While for the cost of sales, it has a total of Php 8,731.00. Regarding the other expenses of BEYOND CLOTHING, they have a total cost of Php 4,020.00. Therefore, overall, the business has a net loss of Php 3,332.00.

BEYOND CLOTHING	
Income Statement	
For the month ended February 2021	
Net Sales	₱5,498.00
Cost of Sales	8,731.00
Gross Income	(3,233.00)
Selling and Distribution Expense	220.00
Net Income (Net Loss)	₱ (3,453.00)

Figure 19. February 2021 Income Statement

In March 2021, still BEYOND CLOTHING did not reach its projected sale of Php 17,350 as they only gained Php 12,698.00 after selling 30 shirts and two (2) of their product diversification. As our projected sales last February were an oversight, we lowered our projected sales so that we may match our product's demand to the market. Regarding the cost of sales, they weren't any purchases and expenses except for the ambassador's short, which accounted for the business's expenses. With this, March has the least total cost of sales, amounting to Php 4,150.00. The net income of the business is Php 8,199.00.

BEYOND CLOTHING	
Income Statement	
For the month ended March 2021	
Net Sales	₱12,698.00
Cost of Sales	4,150.00
Gross Income	8,548.00
Selling and Distribution Expense	349.00
Net Income (Net Loss)	₱ 8,199.00

Figure 20. March 2021 Income Statement



In April 2021, BEYOND CLOTHING exceeded its projected sale of Php 5,498.00 as they garnered Php 12,290.00 from 22 shirts and ten shorts sold. Our projected sales were lower due to not having met the projected last March. They have a remaining inventory of 48 shirts and five pairs of shorts. The business did not have any purchases and expenses except for their remaining stock; thus, the total cost of sales is Php 1,064.00. Overall, the business's net income is Php 11,226.00.

BEYOND CLOTHING	
Income Statement	
For the month ended April 2021	
Net Sales	₱ 12,290.00
Cost of Sales	1,064.00
Gross Income	11,226.00
Selling and Distribution Expense	0.00
Net Income (Net Loss)	₱ 11,226.00

Figure 21. April 2021 Income Statement

From October 2020 to April 27, 2021, the business garnered Php 97,286.00 in sales and Php 91,993.00 in expenses, resulting in a net profit of Php 5,293.00. As a result, the business has an ROI of 17.64% and a net profit margin rate of 0.82% based on the capital. The low ROI and net profit margin can be attributed to the additional units bought due to the projected demand and are now sitting in inventory.

BEYOND CLOTHING	
Income Statement	
October 2020 - April 2021	
Net Sales	₱ 97,286.00
Cost of Sales	88,999.00
Gross Income	8,287.00
Selling and Distribution Expense	2,994.00
Net Income	₱ 5,293.00

Figure 22. October 2020 - April 2021 Income Statement

III. PRODUCT DIVERSIFICATION

BEYOND CLOTHING decided to sell athletic shorts for Php 349.00 as their product diversification as these are in the same product line as their flagship product, which is athletic shirts. The athletic shorts are made with the polyester fabric, Taslan, which makes the shorts solid, stretchable, comfortable, and durable. It features a minimalist design—inclusive of the brand's name on the right leg. It is designed to have a drawstring at the hem for a better fit for the user. The product design was made by the Marketing Officer. In the event that the team would continue to operate the business in the future, a creative team will be included in the planning process.

IV. FUTURE PLANS

All of the members will be signing a memorandum of agreement stating that upon graduation, which is anticipated to occur at the end of Academic Year 2020-2021, two members, which include Jose Crespo and Pia Andrade, desire not to continue as they will be focusing on personal matters, particularly their education. It will also be stated that accordingly, the other members will have agreed to reopen the operations of the business under the same name. The new group plans to complete all the necessary business registrations, trademarks, and copyrights. The new group will be opening a bank account, allowing them to track their cash flow better. They will also develop a website to increase their brand credibility and their accessibility for potential customers.



V. ACKNOWLEDGEMENT

From BEYOND CLOTHING Practical Research A.Y. 2020-2021, they would like to express their sincerest gratitude to one another for the tireless effort and support throughout the business's course of operations. The group also extends their gratitude towards the member's friends and family members who have continuously supported them, and most importantly, towards the business's customers who have helped build and allow the business to grow. BEYOND CLOTHING is especially indebted to Ms. Marife Magsino, who has always been very responsive in providing necessary information and essential advice. Without her generous support, the group would lack motivation and inspiration during their business operations. Through her unwavering support, the group was able to properly experience, obtain, and learn the skills needed in order to run a profitable business properly.

VI. REFERENCES

- Chron Contributor. (2020, October 15). The Importance of Breaking Even in Business Finance. Small Business Chron. <https://smallbusiness.chron.com/importance-breaking-even-business-finance-63132.html>
- Gosselin, V. (2020, October 26). Athleisure wear: A trend movement in the fashion and sportswear industries (Report). Heuritech. <https://www.heuritech.com/blog/articles/athleisure-wear/>
- Kokemuller, C. (2019, June 12). The Importance of Return on Investment. BizFluent. <https://bizfluent.com/about-6397819-importance-return-investment.html>
- Murphy, C. (2021, February 26). Net Profit Margin. Investopedia. https://www.investopedia.com/terms/n/net_margin.asp
- PR Newswire. (2019, October 21). Apparel's Future Will Be Driven by Sportswear's Evolution, Reports NPD (Press Release PR Newswire.). Markets Insider. <https://markets.businessinsider.com/news/stocks/apparel-s-future-will-be-driven-by-sportswear-s-evolution-reports-npd-1028613873>
- Shaftoe, R. (2017, March 29). What is the Purpose of Sales Forecasting?. Sapling. <https://www.sapling.com/6628629/purpose-sales-forecasting>
- Sweeney, O. (2015, June 16). What are balance sheets and why are they important?. Sage. <https://www.sage.com/en-ca/blog/what-why-balance-sheets-important/>
- Woodruff, J. (2019, January 28). Why is Financial Management So Important in Business?. Small Business Chron. <https://smallbusiness.chron.com/financial-management-important-business-57073.html>
- Woodruff, J. (2019, February 6). Role of Finance in a Business. Small Business Chron. <https://smallbusiness.chron.com/role-finance-business-290.html>



Bahay ni Lola



Patricia Anne G. Alvarez, Micah Alyanna B. Canlas, Justin Gabriel M. Casillan,
 Angelica N. Gallardo, and Izaac Gabriel G. Villacarlos
 De La Salle University Integrated School, Manila

Patrick R. Hariramani, MBA, Research Adviser
 De La Salle University

Executive Summary: Bahay ni Lola is a Traditional and Fusion Cuisine Restaurant that aims to provide good quality and nutritious dishes that are affordable to fund our advocacy of raising awareness of the agricultural crisis happening to Filipino farmers. The business aims to support its mission by creating a sustainable social business that provides work to persons with disabilities and at-risk young adults in the business locale by partnering with local social organizations. The business will operate under the form of a corporation type of business structure that is separate and distinct from its owners in the form of a restaurant and caters to dine-in and delivery. This form of business directly helps sustainable acquisition of ingredients for our farm-to-table movement. The market for fusion Filipino food has a promising future as statistics show that growth in this market is considerable per food trends. The business distinguishes itself by providing service with its mix of traditional and fusion Filipino cuisine with an atmosphere of ancestral Bahay na Bato with artifacts that make the customers feel like they are back in their lola or grandmother’s house. The business projects a capital of ₱75,000 along with a budget of ₱15,000 annually for product development of dishes. This will be sourced from the business stakeholders in equal amounts for an equal number of shares and ownership. To date, the company is gathering funds and awaiting a suitable time to launch the business.

Key Words: Filipino; traditional cuisine; fusion cuisine; restaurant management; farm to table

I. BUSINESS REGISTRATION AND ORGANIZATION

Bahay ni Lola is a Traditional and Fusion Filipino Cuisine Restaurant. *Bahay* is a Filipino word that translates to Home and *Lola* to grandmother. The entrepreneurs wanted to make the customers feel nostalgic and reminisce about the past. They wanted to bring back the sense of family where families join at one table, sharing a delicious meal; thus, Bahay ni Lola was established.

Table 1. *Business Model Canvas for Social Enterprise*

Key Partners	Key Activities
<ul style="list-style-type: none"> - Session Groceries and Good Food Community (Suppliers with direct contact to local farmers) - Staff hiring will be at least 80% at-risk young adults and persons with disabilities (PWDs) - MASIPAG 	<ul style="list-style-type: none"> - Stock communication with suppliers to make sure of best quality - Inventory control done religiously to prevent food wastage - Restaurant advertising through social media and minimal area flyering - Support activities like visiting



3RD DLSU SENIOR HIGH SCHOOL RESEARCH CONGRESS

Organization and PAKISAMA Organization will receive a percentage of the profit to support innovation	headquarters of non-profit organizations and communicating about their needs - Hiring and growth program within the staff - Provide a safe environment for both the staff and customers
Value Propositions	Customer Relationships
<ul style="list-style-type: none"> - Fairtrade produce sourced directly from farmers through other social enterprises, "Farm to table movement" - Semi-annual donations to farmer-focused organizations - Sustainable employment for PWDs and at-risk young adults 	<ul style="list-style-type: none"> - Creative promotion of products on social media to pique customers' interest - Customers would know the lack of improvement and fairtrade that farmers suffer from - Honesty and consistency with the enterprise's value propositions - Long-term impact customers would always be encouraged to help - Wider variety of options for the target market - After-sales rating and feedback communication to customers for future corresponding improvements
Customer Segments	Key Resources
<ul style="list-style-type: none"> - Working individuals in the area with no time to cook and wants to support a cause - Group of friends or colleagues finding a place to hang out, enjoy great food and help people - Families that like to dine in or have food 	<ul style="list-style-type: none"> - Impact branding - Goal-driven and well-informed staff - Sufficient local equipment to efficiently serve customers - Ethical practices

delivery and support the cause - Ethical and health-conscious customers - Non-profit organizations, other social enterprises	
Channels	Cost Structure
<ul style="list-style-type: none"> - Social Procurement from accessible online fresh produce stores - Dine-in and online purchases through food delivery applications 	<ul style="list-style-type: none"> - Starting capital would be invested by the founding members - Costs of getting fresh produce stocks and raw materials for ingredients - Cost for administrative and operational activities - Product marketing - Semi-annual Donations
Revenue Streams	
<ul style="list-style-type: none"> - Sales of classic and fusion Filipino dishes - Customers' tips 	

Vision

"Bahay ni Lola imagines a community where everyone has access to good quality and nutritious food and is driven to create a hunger-free CALABARZON through a new kind of restaurant for the Filipino industry that offers traditional and fusion Filipino dishes using farm-to-table movement."

Bahay ni Lola sees itself as an entity that can create a hunger-free community and has access to good quality and nutritious food.

Mission

"Bahay ni Lola strives to provide Filipino dishes that are good quality and nutritious at the same time affordable. The company aims to raise awareness of the agricultural crisis happening in the Philippines that diminishes resources and burdens the livelihoods of farmers by supporting local farmers through farm-to-table movement for a sustainable environment and the development of the country's resources. The company also desires to hire at least 80% of employees that are persons with disabilities and at-risk young adults by partnering up with an organization that seeks to find opportunities for these people within its next two



years of operations.”

The company’s mission adheres to the SMART objectives which are Specific, Measurable, Attainable, Realistic, and Time-bound.

Type of Business Structure

The owners have agreed that Bahay ni Lola will be registered as a Corporation. The entrepreneurs will be equally responsible and liable for significant business actions. The profits of the business will be fairly distributed to stakeholders and organizations that the enterprise aims to support.

Figure 1. Organizational Flow Chart

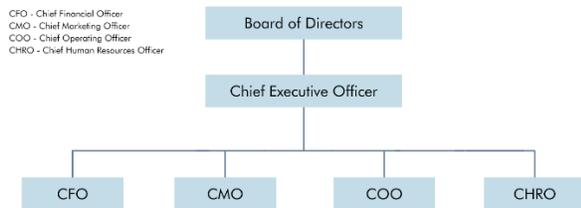

Board of Directors

- The Chief Executive Officer (CEO): Patricia Anne G. Alvarez
- The Chief Financial Officer (CFO): Micah Alyanna B. Canlas
- The Chief Marketing Officer (CMO): Justin Gabriel M. Casillan
- The Chief Human Resources Officer (CHRO): Angelica N. Gallardo
- The Chief Operating Officer (COO): Izaac Gabriel G. Villacarlos

The capital will come from the firm’s stakeholders, which are the Board of Directors. They will invest in Bahay ni Lola which will be used to start its operations.

II. BUSINESS PLAN IMPLEMENTATION

II.A. Production

The Production Process of Bahay ni Lola starts from the acquisition of supplies from local farmers; then supplies will be checked to ensure ingredients meet the quality. The supplies will then be stored in freezers with proper temperature controls to ensure freshness and quality. Once orders are made, ingredients will be prepared and cooked. After, it will then be served to customers. See Figure A1.

The production cost is estimated at ₱21,680, from the menu combined with traditional and fusion Filipino dishes. This includes Pork Caldereta,

Tinolang Manok, Pork Sinigang, and their fusion counterparts. See Table A1 to A6.

II.B. Marketing

Product

Bahay ni Lola offers traditional and fusion Filipino dishes through farm-to-table movement. All the ingredients to be used will fully come from local farmers. It is assured to be high quality for the consumers’ safety and satisfaction.

Price

All dishes range from ₱325-₱480. Bahay ni Lola wanted to provide an avenue where more individuals can afford quality yet affordable food. Their primary market is individuals with an income or allowance of ₱30,000 of any age.

Place

The restaurant is located at an ancestral house at 102 Castillo Street, San Juan, Batangas City. The atmosphere of ancestral *Bahay na Bato* makes the customers feel like they are back in their *lola’s* house.

Promotion

Bahay ni Lola will both utilize online and offline advertising strategies. For online, the company will use social media platforms to promote the restaurant and establish their Internet presence. For the offline advertising strategies, the company will be using posters and flyers.

Market Penetration Strategy

Distribution Channels

The main distribution of the company will be direct selling from the restaurant through dine-ins. The company will also utilize online platforms to reach customers. See Figure A2.

The secondary channels are sales representatives, direct sales force, and direct mail/telemarketing:

1. For sales representatives, the owners will be the point of contact between the business and its customers, which will be led by the CMO.
2. For direct sales force, the business will utilize delivery platforms such as Grabfood and Foodpanda to market the products.
3. For direct mail/telemarketing, the business will give flyers outside the restaurant and utilize Facebook messaging by sending publicity materials to potential customers. They will also answer inquiries in real-time through Messenger. An automatic email



update containing the latest promos and offers will be sent to loyal customers.

II.C. Human Resources

Theory of Change

Figure 2. Theory of Change

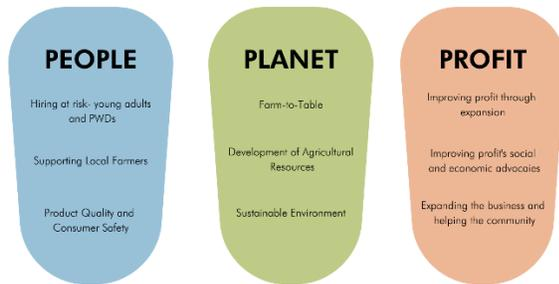

People

Bahay ni Lola will hire at-risk-young adults and PWDs as employees in the restaurant. The company wants to contribute to UNESCO's sustainable development goals of reduced inequalities, decent work and economic growth, and zero hunger. The entrepreneurs wanted to give opportunities to these people as they should also have the right to a job. Furthermore, local farmers in the Philippines are suffering due to the high cost of inputs, low price of *palay*, lack of capital, labor problem, lack of postharvest facilities, and more (Agris, 2009). All the ingredients to be used in the restaurant will fully come from local farmers to support them and promote their products.

Planet

Bahay ni Lola will use farm-to-table movement in providing their dishes. The ingredients that the restaurant will be using are direct acquisitions from the farmers. By supporting local farmers, the company aims to contribute to developing the country's agricultural resources.

Profit

Bahay ni Lola aims to expand the business and reach out to more people with its profit. The company will be expanding by increasing its distribution channels and maximizing its inventories to deliver more products and value to the customers. In addition, Bahay ni Lola strives to increase profit by contributing to developing social and economic goals. The company will invest in good quality materials for the production of the ingredients, specifically from the farmers. It believes that with the growth of the resources, the business provides an avenue where more individuals can

afford quality yet affordable food. The company also aims to gain profit and at the same time help the community in a way that will encourage people to support locals and see the potential of at-risk people.

Reporting to Management

Since the company is a food business, ensuring the best quality and service would require daily updates. A shared Google drive containing necessary documents will be updated. Company email for concerns and feedback will also be open during working hours. Managers appointed to concerns and progress will then assess the information. Twice a week, a separate one-hour meeting of managers' reports to the staff will be conducted. Preparation for the weekly meeting will be done, including the proposal of courses of action or improvements. Lastly, the weekly meeting with the CEO regarding managerial decisions will be done regularly. See Figure A3.

Staff Development

A progressive and healthy working environment will be beneficial to the staff of Bahay ni Lola. Consequently, training and good relationships among staff must be strengthened to establish a dynamic flow.

Job Orientation will help familiarize themselves with the workplace and members. Their roles, responsibilities, and goals will be the main agenda. It is scheduled after recruitment day and will last two days, including simulation at the end.

Rest Days aids in letting the staff recharge. This will also enable them to take good care to prevent absences due to sickness and rest at their comfort two days per week.

Team Building will provide a space for strengthening good communication and relationships. This encompasses retreats, recreational activities, and visits to cause organizations. If possible, it will be done at least four times a year.

An annual Christmas Party will be held to celebrate and be thankful for the fruitful year. Celebrations are important as coworkers and family. Sense of achievement motivates the staff to work more healthily. This can also be a way of giving incentives to some outstanding workers.

Lastly, Job Training will be done yearly. One member per sector of the company will be sent to seminars for more experience. It will be on a rotation basis to provide equal opportunities and development. The ones who went will also be tasked to share their learnings. Staff progress will determine who goes first.



Compensation

All employees will be compensated monthly and receive benefits such as SSS, Pag-IBIG, and PhilHealth. Their salaries vary depending on their position and contribution. Starting salary is ₱12,000 monthly.

Incentives

To encourage and motivate employees, the business will provide incentives to employees. The company will have an annual incentive plan to get additional pay if they reach the prescribed quota.

II.D. Finance

The establishment's main source of financing would be the starting capital of the co-owners of Bahay Ni Lola and a percentage of the profit generated from sales.

Sales Forecasts with Assumptions

Table A7 presents the sales forecast for each dish on the menu, namely: Traditional Pork Caldereta, Pork Caldereta Fusion, Traditional Tinolang Manok, Tinolang Manok Fusion, Traditional Pork Sinigang, and Pork Sinigang Fusion. It is based on the measured break-even units and sales that the company must aim to achieve or exceed monthly in order for its revenue to offset its expenses and the calculated market demand potential. See Table A8 for a more detailed justification and the rationale for the forecasted sales.

Sales Projections

Figure A4 expresses the summation of projected sales from the dishes on the menu, including Traditional Pork Caldereta, Pork Caldereta Fusion, Traditional Tinolang Manok, Tinolang Manok Fusion, Traditional Pork Sinigang, and Pork Sinigang Fusion in the next six months from the start of launch in December.

Figure A5 expresses the continuation of projected sales from the dishes on the menu in the next twelve months from the start of launch in December. As months go nearer to the restaurant's first anniversary, management projects a higher launch of sales as promos and special events occur in December 2021.

Figure A6 expresses the continuation of projected sales from the dishes on the menu in the next twenty-four months from the start of launch in December. Sales are projected to stabilize or even grow following seasons when the dishes are in high demand and when they are not.

Income Projections

Table A9 demonstrates the summation of projected income from the dishes on the menu, including Traditional Pork Caldereta, Pork Caldereta Fusion, Traditional Tinolang Manok, Tinolang Manok Fusion, Traditional Pork Sinigang, and Pork Sinigang Fusion in the next six months from the start of launch in December. This amount has been derived from the net income and deducting the cost of goods sold and operating expenses.

Table A10 demonstrates the continuation of projected income from the dishes on the menu in the next twelve months from the start of launch in December. Net Income generally fluctuates due to the seasonality of the products as well as other events and situations.

Table A11 demonstrates the continuation of projected income from the dishes on the menu in the next twenty-four months from the start of launch in December. Income is projected to stabilize or increase following seasons when the dishes are in high demand and not.

III. PRODUCT DIVERSIFICATION

Bahay ni Lola aims to expand its menu by adding more innovative traditional and fusion Filipino dishes for Breakfast, Lunch, Merienda, and Dinner. The bestsellers for the first six months will remain on the menu, and two new dishes will be added in replacement of the less popular ones. Furthermore, the business plans to expand around the Philippines and outside the country through company-owning. The company will open for franchising, where franchisees will pay the company's royalties and other necessary fees. This will be done with thorough planning and decision-making to maintain the restaurant's concept, values, and authenticity.

IV. FUTURE PLANS

Bahay ni Lola will be settling applications for copyrights to ensure the business's safety and protection from plagiarism and other violations. The business will also settle necessary documents for business licenses to receive operational rights in certain areas in the Philippines and outside the country. Furthermore, Bahay ni Lola will set its royalties that will be shown and discussed to future franchisees of the restaurant.

V. ACKNOWLEDGEMENT

The group offers wishes to show our appreciation to the people who have made this business concept paper completion possible. To our fellow Social Entrepreneurship blockmates, class of ABM 12A, we thank you for the take-aways from the



class consultation with our subject professor. To our Social Entrepreneurship professor, Mr. Patrick R. Hariramani, MBA, thank you for your guidance and consultation advice leading us into the improvement of this business concept paper. With the help of these people, we were able to finish off with a good experience with this paper.

VI. REFERENCES/APPENDICES

- Agriculture and Agri-Food Canada. (2016, July). Global analysis report - Foodservice profile Indonesia. Agriculture and Agri-Food Canada. <https://www.agr.gc.ca/resources/prod/Internet-Internet/MISB-DGSIM/ATS-SEA/PDF/6769-eng.pdf>
- Amari, E. (2017, November 8). A traditional dish with a modern twist. Flavor & The Menu. <https://www.getflavor.com/modern-menu-hits/>
- Arcalas, J. Y. (2020, September 30). Lockdowns seen to cut food service sector's sales by more than half. BusinessMirror. <https://businessmirror.com.ph/2020/09/30/lockdowns-seen-to-cut-food-service-sectors-sales-by-more-than-half/>
- Arnaldo, S. (2020, December 30). 2020: A year in food trends. Rappler. <https://www.rappler.com/life-and-style/food-drinks/food-trends-philippines-year-end-200>
- Arida, I.A. (2010). Problems in rice farming: A Filipino farmers' perspective. Philippine Journal of Crop Science (Philippines). <https://agris.fao.org/agris-search/search.do?recordID=PH2009001446#:~:text=There%20are%20several%20problems%20besetting%20the%20rice%20industry%20in%20the%20country.&text=The%20results%20revealed%20that%20common.and%20diseases%20and%20irrigation%20system>
- Batangas Philippines. (2018, September 16). Batangas: Best time to visit. Batangas Philippines. <https://batangasphilippines.org/batangas-best-time-to-visit/>
- Breakfast Magazine. (n.d.). Pancit tinola: Tinola, Filipino recipes, pancit. Pinterest. <https://www.pinterest.ph/pin/434738170256175686/>
- Bruselas, A. (2020, October 19). Top 10 most loved restaurants in BGC for September 2020. Booky. <https://ph.phonebooky.com/blog/bgc-restaurants/>
- Cacho, K. (2020, February 21). Food deliveries, online shopping activities rise as consumers stay home. Sunstar. <https://ph.news.yahoo.com/food-deliveries-online-shopping-activities-124100965.html?guccounter=1>
- Go, D. (2020, March 18). Here's the situation with Grab Food, Food Panda and Lalafood during the Coronavirus. When In Manila. <https://www.wheninmanila.com/heres-the-situation-with-grab-food-food-panda-and-lalafood-during-the-coronavirus/>
- Jujanester. (2020, August 9). Pinoy life: Classic Filipino traits and characteristics. Owlcation. <https://owlcation.com/social-sciences/Filipino-Traits-and-Characteristics>
- Locavore Kitchen & Drinks. (n.d.). Kimchinigang. Locavore. <https://www.locavore.ph/>
- Lumbre, H. (2020, June). 8 quarantine food trends Filipinos are trying that you can cook in your own kitchen. The Smart Local Philippines. <https://thesmartlocal.com/philippines/quarantine-food-trends/>
- Maggi. (2020). Pork Caldereta. Maggi. <https://www.maggi.ph/recipes/pork-caldareta/>
- Merano, V. (2019, January 2). Tinolang manok recipe. Panlasang Pinoy. <https://panlasangpinoy.com/classic-tinolang-manok-recipe/>
- Merano, V. (2019, March 10). Sinigang recipe. Panlasang Pinoy. <https://panlasangpinoy.com/pork-sinigang-na-baboy-recipe/>
- Mordor Intelligence. (2016). Philippines foodservice market - growth, trends, COVID-19 impact, and forecasts (2021 - 2026). Mordor Intelligence. <https://www.mordorintelligence.com/industry-reports/philippines-foodservice-market>
- Masigan, A. (2019, June 17). Trends in the food industry. Business World. <https://www.bworldonline.com/trends-in-the-food-industry/>
- Nuestro, E. (2020, April 24). Opinion: The future of restaurants in the Philippines and how F&B industry can bounce back. Tatler Philippines. <https://ph.asiatatler.com/dining/the-future-of-restaurants-in-the-philippines-how-fb-industry-can-bounce-back>
- PhilAtlas. (2020). San Juan, Province of Batangas. PhilAtlas. <https://www.philatlas.com/luzon/r04a/batangas/san-juan.html>
- The Booky Team. (2020, July 8). Top 10 most loved Filipino restaurants in Metro Manila. Booky. <https://ph.phonebooky.com/blog/restaurants-filipino/>
- The Moment Group. (n.d.). Brands. The Moment Group. <https://momentgroup.ph/brands/show/manam>
- The Pigpen. (n.d.). About. The Pigpen. <https://www.pigpenph.com/>
- The State of Food Security and Nutrition in the World 2020. (2020). Transforming food systems for affordable healthy diets. The State of Food Security and Nutrition in the World 2020. <http://www.fao.org/3/ca9692en/online/ca9692en.html>
- The Straits Times/Asia News Network. (2020, August 16). Filipinos eke out a living online as COVID-19 pandemic decimates jobs and incomes. Business Inquirer. <https://business.inquirer.net/305393/filipinos-eke-out-a-living-online-as-covid-19-pandemic-decimates-jobs-and-incomes>
- Tripadvisor. (n.d.). The 10 best fusion restaurants in Metro Manila. Tripadvisor. https://www.tripadvisor.com.ph/Restaurants-g298449-c17-Metro_Manila_Luzon.html
- WWF Philippines. (2019). WWF-Philippines, BPI Foundation, SRA inaugurate innovative food houses in Negros Occidental. WWF Philippines. <https://wwf.org.ph/resource-center/story-archives-2019/food-house-inauguration/>
- Yu, H. (2017, June 7). Sneak peek: The Pigpen is the laid-back hangout you need in your busy life. Spot.ph. <https://www.spot.ph/eatdrink/the-latest-eat-drink/70383/pigpen-legazpi-village-makati-city-a00198-20170607-lfrm>



Appendices

Table A1. Pork Caldereta

	Price	Quantity	Total:
Pork (1kg)	₱ 217.6	5	₱ 1,088
Tomato Sauce (1kg)	₱ 75	2	₱ 150
Green Olives (935g)	₱ 250	1	₱ 250
Red Bell Pepper (250g)	₱ 89	2	₱ 178
Green Bell Pepper (250g)	₱ 99	2	₱ 198
Potatoes (1kg)	₱ 102	2	₱ 204
Carrots (1kg)	₱ 169	2	₱ 338
Onions (1kg)	₱ 179	2	₱ 358
Minced Garlic (227g)	₱ 179	2	₱ 358
Beef Broth (100g)	₱ 133	3	₱ 399
Liver spread (25g)	₱ 29	5	₱ 145
Cooking oil (2L)	₱ 169	2	₱ 338
TOTAL:			₱ 4,004

Table A2. Pork Caldereta Fusion

	Price	Quantity	Total:
Pork (1kg)	₱ 217.6	5	₱ 1,088
Tomato Sauce (1kg)	₱ 75	2	₱ 150
Green Olives (935g)	₱ 250	1	₱ 250
Red Bell Pepper (250g)	₱ 89	2	₱ 178
Green Bell Pepper (250g)	₱ 99	2	₱ 198
Potatoes (1kg)	₱ 102	2	₱ 204
Carrots (1kg)	₱ 169	2	₱ 338
Onions (1kg)	₱ 179	2	₱ 358
Minced Garlic (227g)	₱ 179	2	₱ 358
Beef Broth (100g)	₱ 133	3	₱ 399
Liver spread (25g)	₱ 29	5	₱ 145

Cooking oil (2L)	₱ 169	2	₱ 338
Rice (10 kg)	₱ 550	1	₱ 550
TOTAL:			₱ 4,554

Table A3. Tinolang Manok

	Price	Quantity	Total:
Chicken (1kg)	₱ 130	5	₱ 650
Malunggay leaves (4 bundles)	₱ 89	2	₱ 178
Black Pepper (500g)	₱ 140	1	₱ 140
Unripe papaya	₱ 69	5	₱ 345
Knorr chicken cubes (600g)	₱ 258	1	₱ 258
Onions (1kg)	₱ 179	2	₱ 358
Garlic (1kg)	₱ 189	2	₱ 378
Ginger (500g)	₱ 159	2	₱ 318
Fish Sauce (1L)	₱ 59	1	₱ 59
Vegetable oil (1.8L)	₱ 169	1	₱ 169
Water	To be provided		
TOTAL:			₱ 2,853

Table A4. Tinolang Manok Fusion

	Price	Quantity	Total:
Chicken (1kg)	₱ 130	5	₱ 650
Malunggay leaves (4 bundles)	₱ 89	2	₱ 178
Black Pepper (500g)	₱ 140	1	₱ 140
Unripe papaya	₱ 69	5	₱ 345
Knorr chicken cubes (600g)	₱ 258	1	₱ 258
Onions (1kg)	₱ 179	2	₱ 358
Garlic (1kg)	₱ 189	2	₱ 378
Ginger (500g)	₱ 159	2	₱ 318
Fish Sauce (1L)	₱ 59	1	₱ 59



3RD DLSU SENIOR HIGH SCHOOL RESEARCH CONGRESS

BUSINESS CONCEPT BAZAAR

Vegetable oil (1.8L)	₱ 169	1	₱ 169
Spaghetti Pasta (900g)	₱ 76	3	₱ 228
TOTAL:			₱ 3,081

Table A5. Pork Sinigang

	Price	Quantity	Total:
Pork belly (1kg)	₱ 349	3	₱ 1,047
Spinach(1kg)	₱ 289	1	₱ 289
Fish Sauce (1L)	₱ 59	1	₱ 59
String beans (1kg)	₱ 229	1	₱ 229
Tomato (1kg)	₱ 159	2	₱ 318
Chilli pepper	₱ 199	2	₱ 398
Cooking oil (2L)	₱ 169	2	₱ 338
Onions (1kg)	₱ 179	2	₱ 358
Taro (500g)	₱ 109	2	₱ 218
Sinigang Mix (22g)	₱ 12	10	₱ 120
Water	To be provided		
TOTAL:			₱ 3,374

Table A6. Pork Sinigang Fusion

	Price	Quantity	Total:
Pork belly (1kg)	₱ 349	3	₱ 1,047
Spinach(1kg)	₱ 289	1	₱ 289
Fish Sauce (1L)	₱ 59	1	₱ 59
String beans (1kg)	₱ 229	1	₱ 229
Tomato (1kg)	₱ 159	2	₱ 318
Chilli pepper	₱ 199	2	₱ 398
Cooking oil (2L)	₱ 169	2	₱ 338
Onions (1kg)	₱ 179	2	₱ 358
Taro (500g)	₱ 109	2	₱ 218
Sinigang Mix (22g)	₱ 12	10	₱ 120

Water	To be provided		
Kimchi (1kg)	₱ 220	2	₱ 440
TOTAL:			₱ 3,814

Table A7. Sales Forecasts

Traditional Pork Caldereta						
	Dec 2020	Jan 2021	Feb 2021	Mar 2021	Apr 2021	May 2021
Number of Units	35	25	23	19	29	26
Unit Price	₱ 345	₱ 345	₱ 345	₱ 345	₱ 345	₱ 345
Total Sales	₱ 12,075	₱ 8,625	₱ 7,935	₱ 6,555	₱ 10,005	₱ 8,970
TOTAL	₱ 54,165					

Pork Caldereta Fusion						
	Dec 2020	Jan 2021	Feb 2021	Mar 2021	Apr 2021	May 2021
Number of Units	32	20	23	22	27	18
Unit Price	₱ 400	₱ 400	₱ 400	₱ 400	₱ 400	₱ 400
Total Sales	₱ 12,800	₱ 8,000	₱ 9,200	₱ 8,800	₱ 10,800	₱ 7,200
TOTAL	₱ 56,800					

Traditional Tinolang Manok						
	Dec 2020	Jan 2021	Feb 2021	Mar 2021	Apr 2021	May 2021
Number of Units	29	17	21	25	19	23
Unit Price	₱ 325	₱ 325	₱ 325	₱ 325	₱ 325	₱ 325



3RD DLSU SENIOR HIGH SCHOOL RESEARCH CONGRESS

BUSINESS CONCEPT BAZAAR

Total Sales	₱ 9,425	₱ 5,525	₱ 6,825	₱ 8,125	₱ 6,175	₱ 7,475
TOTAL	₱ 43,550					

Tinolang Manok Fusion						
	Dec 2020	Jan 2021	Feb 2021	Mar 2021	Apr 2021	May 2021
Number of Units	34	24	20	16	27	19
Unit Price	₱ 375	₱ 375	₱ 375	₱ 375	₱ 375	₱ 375
Total Sales	₱ 12,750	₱ 9,000	₱ 7,500	₱ 6,000	₱ 10,125	₱ 7,125
TOTAL	₱ 52,500					

Traditional Pork Sinigang						
	Dec 2020	Jan 2021	Feb 2021	Mar 2021	Apr 2021	May 2021
Number of Units	29	21	15	23	25	27
Unit Price	₱ 420	₱ 420	₱ 420	₱ 420	₱ 420	₱ 420
Total Sales	₱ 12,180	₱ 8,820	₱ 6,300	₱ 9,660	₱ 10,500	₱ 11,340
TOTAL	₱ 58,800					

Pork Sinigang Fusion						
	Dec 2020	Jan 2021	Feb 2021	Mar 2021	Apr 2021	May 2021
Number of Units	32	24	21	23	29	19
Unit Price	₱ 480	₱ 480	₱ 480	₱ 480	₱ 480	₱ 480
Total Sales	₱ 15,360	₱ 11,520	₱ 10,080	₱ 11,040	₱ 13,920	₱ 9,120
TOTAL	₱ 71,040					

Table A8. Assumptions

Month	Assumptions
December	Units sold for: 191 Traditional Pork Caldereta - 35 Pork Caldereta Fusion - 32 Traditional Tinolang Manok - 29 Tinolang Manok Fusion - 34 Traditional Pork Sinigang - 29 Pork Sinigang Fusion - 32 <i>Peak Season due to holidays Christmas and New year's eve.</i>
January	Units sold for: 131 Traditional Pork Caldereta - 25 Pork Caldereta Fusion - 20 Traditional Tinolang Manok - 17 Tinolang Manok Fusion - 24 Traditional Pork Sinigang - 21 Pork Sinigang Fusion - 24 <i>Due to the spending from the Christmas season / December peak season, people's spending power will decrease.</i>
February	Units sold for: 123 Traditional Pork Caldereta - 23 Pork Caldereta Fusion - 23 Traditional Tinolang Manok - 21 Tinolang Manok Fusion - 20 Traditional Pork Sinigang - 15 Pork Sinigang Fusion - 21 <i>February is Valentine's season. People will be much more likely to go out or order food to celebrate.</i>
March	Units sold for: 128 Traditional Pork Caldereta - 19 Pork Caldereta Fusion - 22 Traditional Tinolang Manok - 25 Tinolang Manok Fusion - 16 Traditional Pork Sinigang - 23 Pork Sinigang Fusion - 23 <i>Non-peak season</i>
April	Units sold for: 156 Traditional Pork Caldereta - 29 Pork Caldereta Fusion - 27 Traditional Tinolang Manok - 19 Tinolang Manok Fusion - 27 Traditional Pork Sinigang - 25 Pork Sinigang Fusion - 29 <i>Summer / Holy week season. People go out to eat with their families. There will also be no classes from April until May. More time to spend time with family and friends.</i>
May	Units sold for: 132 Traditional Pork Caldereta - 26 Pork Caldereta Fusion - 18 Traditional Tinolang Manok - 23 Tinolang Manok Fusion - 19 Traditional Pork Sinigang - 27 Pork Sinigang Fusion - 19 <i>End of the summer season, people will go out less. Preparing to go back to work and classes.</i>

Table A9. Income Projections for the first 6 months

Pro-forma 6-month Income Projections of Bahay ni Lola For the Six Months Ended May 31, 2021
--



3RD DLSU SENIOR HIGH SCHOOL RESEARCH CONGRESS

BUSINESS CONCEPT BAZAAR

	Dec 2020	Jan 2021	Feb 2021	Mar 2021	Apr 2021	May 2021
Net Sales	₱ 7 4,590	₱ 5 1,490	₱ 4 7,840	₱ 5 0,180	₱ 6 1,525	₱ 5 1,230
Less: Cost of Goods Sold	(46,2 16.44)	(31,7 34.02)	(29,9 37.80)	(30,8 13.64)	(38,0 94.56)	(31,5 86.23)
Gross Profit	₱28,3 73.56	₱19,7 55.98	₱17,9 02.20	₱19,3 66.36	₱23,4 30.44	₱19,6 43.77
Less: Operating Expenses	(11,1 88.50)	(7,72 3.50)	(7,17 6)	(7,52 7)	(9,22 8.75)	(7,68 4.50)
Net Income	₱ 17,18 5.06	₱ 12,032. 48	₱ 10,726. 20	₱ 11,839. 36	₱ 14,201. 69	₱ 11,959. 27
Total Net Income for 6 Months						₱ 77,94 4.06

Table A10. Income Projections for the first 12 months

Pro-forma 12-month Income Projections of Bahay ni Lola For the Twelve Months Ended November 30, 2021						
	Dec 2020	Jan 2021	Feb 2021	Mar 2021	Apr 2021	May 2021
Net Sales	₱ 7 4,590	₱ 5 1,490	₱ 4 7,840	₱ 5 0,180	₱ 6 1,525	₱ 5 1,230
Less: Cost of Goods Sold	(46,2 16.44)	(31,7 34.02)	(29,9 37.80)	(30,8 13.64)	(38,0 94.56)	(31,5 86.23)
Gross Profit	₱28,3 73.56	₱19,7 55.98	₱17,9 02.20	₱19,3 66.36	₱23,4 30.44	₱19,6 43.77
Less: Operating Expenses	(11,1 88.50)	(7,72 3.50)	(7,17 6)	(7,52 7)	(9,22 8.75)	(7,68 4.50)
Net Income	₱ 17,18 5.06	₱ 12,032. 48	₱ 10,726. 20	₱ 11,839. 36	₱ 14,201. 69	₱ 11,959. 27

Pro-forma 12-month Income Projections of Bahay ni Lola For the Twelve Months Ended November 30, 2021						
	Jun 2021	Jul 2021	Aug 2021	Sept 2021	Oct 2021	Nov 2021
Net Sales	₱ 5 0,180	₱ 6 1,525	₱ 5 1,230	₱ 7 4,590	₱ 5 1,490	₱ 4 7,840
Less: Cost of Goods Sold	(30,8 13.64)	(38,0 94.56)	(31,5 86.23)	(46,2 16.44)	(31,7 34.02)	(29,9 37.80)

Gross Profit	₱ 19,36 6.36	₱ 23,43 0.44	₱ 19,64 3.77	₱28,3 73.56	₱19,7 55.98	₱ 17,90 2.20
Less: Operating Expenses	(7,52 7)	(9,22 8.75)	(7,68 4.50)	(11,1 88.50)	(7,72 3.50)	(7,17 6)
Net Income	₱ 11,83 9.36	₱ 14,20 1.69	₱ 11,95 9.27	₱ 17,18 5.06	₱ 12,03 2.48	₱ 10,72 6.20
Total Net Income for 12 Months					₱155,888.12	

Table A11. Income Projections for the first 24 months

Pro-forma 24-month Income Projections of Bahay ni Lola For the Twenty-four Months Ended November 30, 2022						
	Dec 2020	Jan 2021	Feb 2021	Mar 2021	Apr 2021	May 2021
Net Sales	₱ 7 4,590	₱ 5 1,490	₱ 4 7,840	₱ 5 0,180	₱ 6 1,525	₱ 5 1,230
Less: Cost of Goods Sold	(46,2 16.44)	(31,7 34.02)	(29,9 37.80)	(30,8 13.64)	(38,0 94.56)	(31,5 86.23)
Gross Profit	₱28,3 73.56	₱19,7 55.98	₱17,9 02.20	₱19,3 66.36	₱23,4 30.44	₱19,6 43.77
Less: Operating Expenses	(11,1 88.50)	(7,72 3.50)	(7,17 6)	(7,52 7)	(9,22 8.75)	(7,68 4.50)
Net Income	₱ 17,18 5.06	₱ 12,032. 48	₱ 10,726. 20	₱ 11,839. 36	₱ 14,201. 69	₱ 11,959. 27

Pro-forma 24-month Income Projections of Bahay ni Lola For the Twenty-four Months Ended November 30, 2022						
	Jun 2021	Jul 2021	Aug 2021	Sept 2021	Oct 2021	Nov 2021
Net Sales	₱ 5 0,180	₱ 6 1,525	₱ 5 1,230	₱ 7 4,590	₱ 5 1,490	₱ 4 7,840
Less: Cost of Goods Sold	(30,8 13.64)	(38,0 94.56)	(31,5 86.23)	(46,2 16.44)	(31,7 34.02)	(29,9 37.80)
Gross Profit	₱ 19,36 6.36	₱ 23,43 0.44	₱ 19,64 3.77	₱28,3 73.56	₱19,7 55.98	₱ 17,90 2.20
Less: Operating Expenses	(7,52 7)	(9,22 8.75)	(7,68 4.50)	(11,1 88.50)	(7,72 3.50)	(7,17 6)
Net Income	₱ 11,83 9.36	₱ 14,20 1.69	₱ 11,95 9.27	₱ 17,18 5.06	₱ 12,03 2.48	₱ 10,72 6.20



3RD DLSU SENIOR HIGH SCHOOL RESEARCH CONGRESS

BUSINESS CONCEPT BAZAAR

Pro-forma 24-month Income Projections of Bahay ni Lola For the Twenty-four Months Ended November 30, 2022

	Dec 2021	Jan 2022	Feb 2022	Mar 2022	Apr 2022	May 2022
Net Sales	P 7,459.00	P 5,149.00	P 4,784.00	P 5,018.00	P 6,152.50	P 5,123.00
Less: Cost of Goods Sold	(46,216.44)	(31,734.02)	(29,937.80)	(30,813.64)	(38,094.56)	(31,586.23)
Gross Profit	P 28,373.56	P 19,755.98	P 17,902.20	P 19,366.36	P 23,430.44	P 19,643.77
Less: Operating Expenses	(11,188.50)	(7,723.50)	(7,176)	(7,527)	(9,228.75)	(7,684.50)
Net Income	P 17,185.06	P 12,032.48	P 10,726.20	P 11,839.36	P 14,201.69	P 11,959.27

Pro-forma 24-month Income Projections of Bahay ni Lola For the Twenty-four Months Ended November 30, 2022

	Jun 2022	Jul 2022	Aug 2022	Sept 2022	Oct 2022	Nov 2022
Net Sales	P 5,018.00	P 6,152.50	P 5,123.00	P 7,459.00	P 5,149.00	P 4,784.00
Less: Cost of Goods Sold	(30,813.64)	(38,094.56)	(31,586.23)	(46,216.44)	(31,734.02)	(29,937.80)
Gross Profit	P 19,366.36	P 23,430.44	P 19,643.77	P 28,373.56	P 19,755.98	P 17,902.20
Less: Operating Expenses	(7,527)	(9,228.75)	(7,684.50)	(11,188.50)	(7,723.50)	(7,176)
Net Income	P 11,839.36	P 14,201.69	P 11,959.27	P 17,185.06	P 12,032.48	P 10,726.20
Total Net Income for 24 Months						P 311,776.24

Figure A1. Production Process

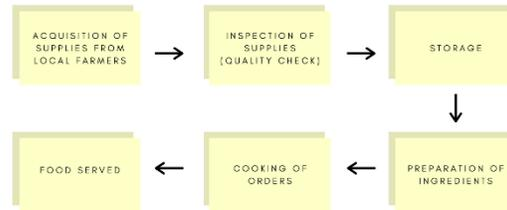

Figure A2. Distribution Channels

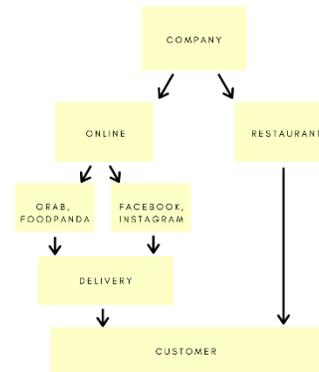

Figure A3. Reporting to Management

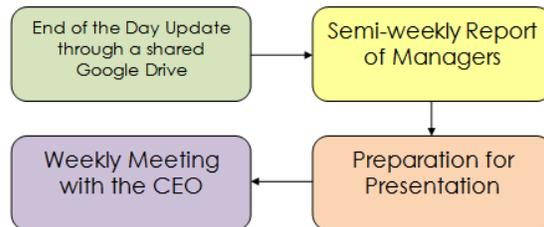

Figure A4. Projected Sales for 6 months



Figure A5. Projected Sales for 12 months



3RD DLSU SENIOR HIGH SCHOOL RESEARCH CONGRESS

2020-2021

BUSINESS CONCEPT BAZAAR

Projected Sales (12 Months)

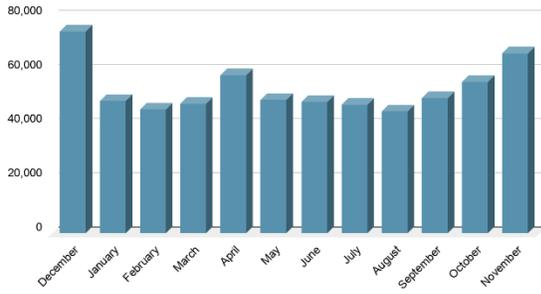
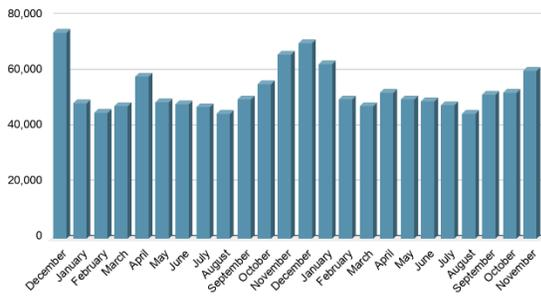

Figure A6. Projected Sales for 24 months

Projected Sales (24 Months)





HIRAYA
HIRAYA
EST. 2020

Jin Ha C. Kim, Jan Marc M. Portal, Aerial Amber B. Punzalan, Jiro Mhaye N. Salayo,
Jarvis Karl P. Serviño, and Katriona Ashley C. Ureta
De La Salle University Integrated School, Biñan City, Laguna

Generie M. Manuel, *Research Adviser*
De La Salle University Integrated School, Biñan City, Laguna

Executive Summary: Hiraya is a sole proprietorship business founded in February 2020 by Jan Marc Portal, an ABM student in DLSU-SHS. Its mission is to provide the community with pouch bags that feature sustainability, affordability, and durability, promoting the Philippines’ indigenous designs using locally sourced materials such as Abaca and cotton canvas. Hiraya’s vision is to create a convenient and practical experience for the general lifestyle of the people by catering local products. The owner formed a business venture with his co-students in the ABM Strand, namely: Aerial Punzalan (operations), Jarvis Servino (financial), Katriona Ureta (marketing), Jin Ha Kim (human resource), and Jiro Mhaye Salayo (advertising). The officers possess individual skills related to their departments, such as leadership, project management, and marketing, contributing to the development of Hiraya. The business took the opportunity to sell products through the online platform, reaching millennials and Gen-Z as its target market. The business’s location was strategically placed in Laguna. The venture considers itself to be different from its competitors as it features an accented Abaca design inspired by local Kalinga tattoo artists in its products. In terms of the initial capital, the business had invested Php 31,500 to operate. The capital was able to produce 120 bags, costing Php 349 each (39.6% mark-up). Once the break-even is reached, Hiraya intends to diversify its products by putting another Php 27,488 for capital. Hiraya plans to continually expand in the future to remain true to its cause in helping indigenous people as part of its social responsibility.

Key Words: pouch bags; indigenous; abaca; business venture; online business

I. BUSINESS REGISTRATION AND ORGANIZATION

Hiraya is a sole proprietorship business. As such, necessary papers like the BIR form (1901), mayor’s permit, and the DTI business registration name were complied with to attain legal status and to satisfy the requirements of the law (Department of Trade Industry [D.T.I.], n.d.). It was essential ethical compliance for better operational procedures that promote good relationships and a good reputation. Although the business is only a simulation, the officers felt it was important to fill out the forms for learning purposes as well as for their plans to eventually create a real business venture in the future. Each registration form was

assessed by the group, observing its relevance for their business operations.





Figure 1.1 - 1.4, Figure 2.2 - 2.3 & Figure 3.1 - 3.3.
*BIR Form (1901), Mayor's Permit, and DTI
 Registration Name*

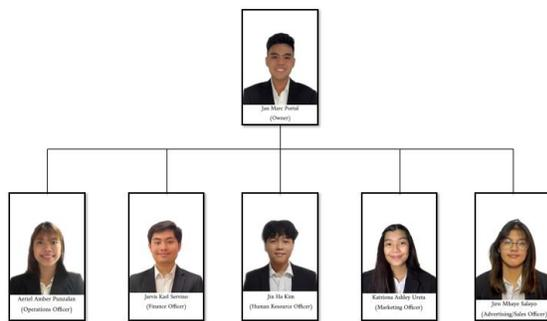

Figure 4. *Organizational Chart*

Hiraya, founded by Jan Marc Portal from De La Salle University Laguna in 2020, is a starting business. Its structure is sole proprietorship since Davidson (2016) implies that it is efficient, simple, and an inexpensive structure made for small businesses. Through observation, the owner saw an opportunity to produce pouch bags made out of cotton canvas and Abaca accented design, which is inspired by local tattoo Kalinga artists, to provide convenience and practicality towards consumers (Sara, 2016). The owner then decided to create a business venture with the help of his classmates to answer the call of “community” stressed by St. La Salle in his teachings as well as to show sustainability and durability as Hiraya’s strength—emphasizing the business’ responsibilities and obligations.

The owner, Jan Marc Portal, was responsible for monitoring the actions done by the whole business as well as leading the business towards growth and development through proper management and communication.

The Operations Officer, Aerial Punzalan, was responsible for every operational technicality the business creates and monitors the budget, managing margins, and monitoring actions of the inventory.

The Financial Officer, Jarvis Karl Servino, was responsible for creating forecasts, monitoring

the financial health of the business, creating reports regarding the cash flow that occurs within the business, and analyzing and maximizing the profit for the future plans of the business.

The Human Resource Officer, Jin Ha Kim, was responsible for creating an effective development plan and solution to meet the business’ goals and objectives as well as encouraging the employees.

The Marketing Officer, Katriona Ashley Ureta, was responsible for conceptualizing the best marketing strategy possible for the business to expand, as well as for monitoring and assessing the direct competitors in the market to create the best pricing strategy.

Lastly, the Advertising/Sales Promotions Officer, Jiro Mhaye Salayo, has a crucial role in planning the advertisements of the business to exhibit towards the target market as well as product diversification.

II. BUSINESS PLAN IMPLEMENTATION

II.A. Production

The Operations Officer reached out to Gian Tulalian, one of the owners of Carry One, to ask for details about their supplier. In September 2020, Hiraya started working with Edward Sewing and Printing Services. All the raw materials were provided by the supplier.

Hiraya made prototypes before the actual production to ensure the best quality product for the business; they made three prototypes before the actual production, which amounted to PHP1,500.00. The business then ordered a total of 120 bags, 30 for each color: Malamaya, Dagtum, Kayumanggi, and Luntian.

Hiraya bought Kraft Papers from Skills & Craft and labeled tags from R&R Creative; amounted to PHP1,225.00. After receiving the inventory and the packaging materials, Hiraya conducted quality control and packed the bags. The beginning inventory was divided between Jiro Salayo and Katriona Ureta. Aerial Punzalan was responsible for shipping through J&T and the rest of the officers for meet-ups. The business monitored the inventory through an excel sheet which was shared with all the officers to ensure correct information and data.

Consequently, the business started planning for product diversification. The business came to the decision that it would be best to reach out to their initial supplier, Springworks Inc., for product diversification. Jiro Salayo talked with the



initial supplier about their current situation and the ability to work with the business. Hiraya is working with the initial supplier for product diversification and still working hard to sell out the rest of the inventory left in the business.

II.B. Marketing

Product

Hiraya's products maximized the local materials available here in the Philippines, wherein the idea of using abaca and cotton canvas was brought up to be different from its competitors. The business focused on the minimalist look of the bag as it is one of the factors consumers look for (VanEeno, 2011). The pouch bag consists of two colors, and each base color has its Tagalog term as the name used for the product. Furthermore, the bags are also made to be convenient to the customers in the pandemic situation. The bag was designed to be big enough for necessary belongings to fit and be secured, which also comes with an interchangeable strap.

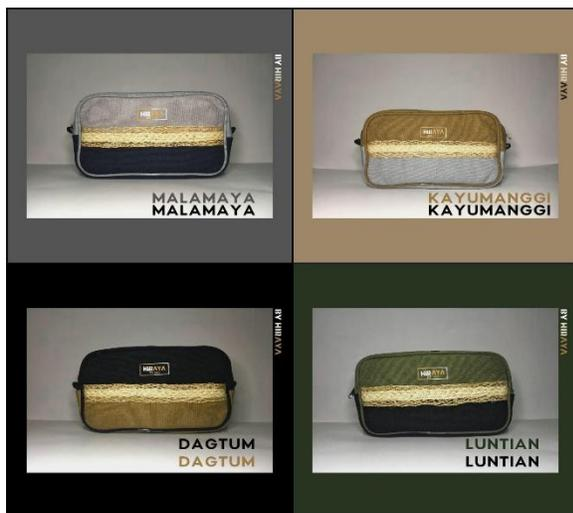

Figure 5. HIRAYA's Products

Table 1. Inventory as of March 15, 2021

Product	Price	Pieces Sold	Inventory
Malamaya	Php349	30	2
Dagtum	Php349	24	5
Kayumanggi	Php349	23	10
Luntian	Php349	17	9

Price

Table 2. Product Cost for Pouch Bags

Product	Cost	Mark-up rate	Selling Price
Bag	Php 250.00	39.6%	Php 349.00

As stated in Table 2 above, the pricing implemented the penetration strategy, focusing on setting the prices as low as possible to generate a higher profit percentage (Kenton, 2020). A mark-up rate of 39.6% was used as a basis for the pricing with a production cost of Php 240.00, including Php 10.00 for the packaging.

Place

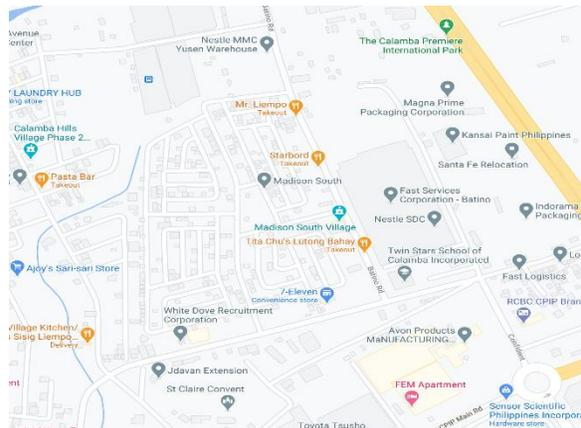

Figure 6. Hiraya's address

Hiraya's main business address is located at Madison South, Batino, Calamba City, Laguna. However, the business was handled by officers from different cities of Laguna, specifically in Biñan, Calamba, and Santa Rosa City.

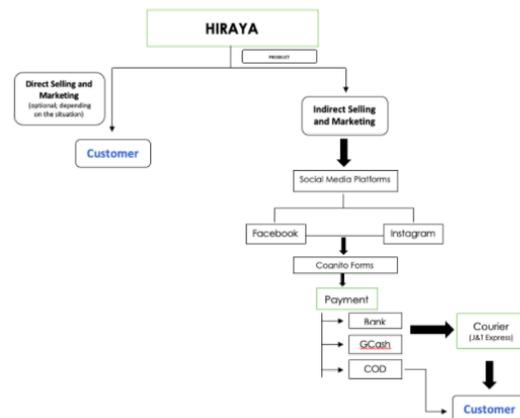

Figure 7. Distribution Channels



Hiraya has been using different social media platforms to sell its product. Facebook and Instagram allow its customers to directly communicate with the seller, which is generally easy to manage (*Business Queensland, 2016*). Customers were required to fill up a Cognito Form as a sign of validity for their order. Since COVID-19 struck, its stocks were only handled by their Marketing and Advertising Officers for safety and convenience purposes. When delivering the products, a meet-up was conducted to distribute the product to the said customer. Simultaneously, the Operations Officer would take shipping orders to the courier.

Promotion

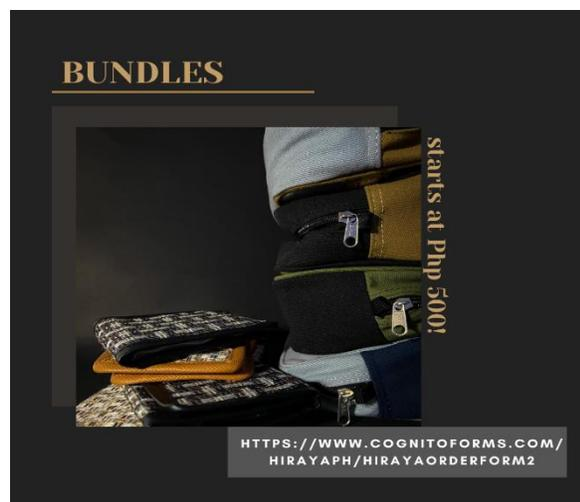

Figure 8. Bundle Promotion

In the current setup, the use of social media was maximized as it was the most efficient and inexpensive way to reach out to the target market. The officers have thought of creating a bundle in order to sell out the remaining flagship product and sell the product diversification as well. Given that there was more inventory for the product diversification, the marketing strategy for it has to be better in which once the break-even was reached, a buy-1-take-1 or discount strategy will have to be applied.

II.C. Human Resources

Hiraya currently has six personnel, and each of the members was assigned in their positions due to their individual skills and capabilities. According to Stark (2019), every business owner must have leadership skills to motivate their people towards their goal; thus, Jan Marc Portal was assigned as the owner of the business due to his skills in planning, and organizing, and creating

proper decisions. Aerial Punzalan was assigned as Operations Officer because of the diligent characteristic she possesses and the driving force on doing the things needed for the business (Freedman, 2020). Jiro Mhaye Salayo was assigned as the Advertising/sales Officer due to her artistic skills in creating posters and attractions. Katriona Ureta was assigned as the Marketing Officer due to her skills in generating ideas to persuade and sustain the consumer’s need for the products of the business. Jarvis Servino was assigned as the Financial Officer due to his efficient mathematical abilities and proper awareness in handling the money of the business. Lastly, Jin Ha Kim was assigned as the Human Resource Officer due to his skills in dealing with people, such as communicating with the suppliers as well as his ability to handle customer and officer relationships.

Table 3. Compensation Package of the officers per year

Owner	Php 530,000
Operations Manager	Php 303,000
Marketing Manager	Php 400,000
Advertising Manager	Php 400,000
Finance Manager	Php 534,000
Human Resources Manager	Php 297,000

After liquidation and when the officers continue their business venture as well as retain their roles in the industry, their annual pay stated in table 3 will be their average salary. According to PayScale (2021), a compensation software and data company, officers or managers that have less than one year of experience have an annual salary ranging from Php 297,000 to Php 534,000. When Hiraya grows and develops in the future, the owner and each officer can expect the estimated compensation package stated in the table.

II.D. Finance

Jarvis Karl Servino, the Financial Officer, opened a bank account for the business on October 15, 2020. The officers transferred Php 6,700.00 each (six officers) for Hiraya’s initial capital and maintaining balance. Hiraya paid their supplier, Edward Sewing and Printing Services, Php 15,000.00 as a downpayment. The business also paid R&R Creatives and Skills&Craft for the packaging for a total of Php 1,200.00. The business then paid Php 15,300.00 to their supplier to complete the payment for the bags and Php 1,500.00 for three prototypes on October 10, 2020.

The business has no operating expense because when it comes to the shipping fee, the consumers shouldered the expense, which was added to the pricing of the product they bought.

Furthermore, other expenses such as gas, water, and electricity were not included since it was just a business simulation and there was no proper place where the group sold their products like bazaars and tents in malls and parks that require operating expenses.

Hiraya started producing their product diversification which was a wallet and had an initial capital of Php 27,488.00. The capital was used for the production which amounted to Php 26,900.00, and its packaging amounted to Php 588.00. The men's wallet was sold for Php 200.00, while the women's wallet was sold for Php 240.00. The wallets have the same markup rate which is 60% of the cost of the wallet. A total of 63 wallets or Php 27,720.00 must be sold to achieve its breakeven.

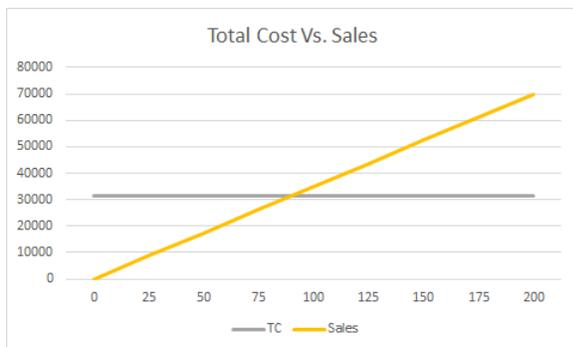

Figure 9. Break-even for Bags

HIRAYA INCOME STATEMENT As of April 23, 2021			
Revenue			
Sales			
	Malamaya	31	P 10,819.00
	Dagtum	27	9,423.00
	Kayumanggi	24	8,376.00
	Luntian	19	6,631.00
	Men's Takipsilim	4	800.00
	Men's Bukangliwa	1	200.00
	Women's Takipsilim	2	480.00
	Women's Bukangliwa	3	720.00
	Total Sales		P 37,449.00
Less: Cost of Sales			
	Malamaya	31	P 7,440.00
	Dagtum	27	6,480.00
	Kayumanggi	24	5,760.00
	Luntian	19	4,560.00
	Packaging		1,010.00
	Prototypes		1,500.00
	Men's Takipsilim	4	488.00
	Men's Bukangliwa	1	122.00
	Women's Takipsilim	2	294.00
	Women's Bukangliwa	3	441.00
	Packaging		30.00
	Total Cost of Sales		P 28,125.00
	Net Sales		P 9,324.00
Less: Operating Expenses			
			0.00
	Net Income		P 9,324.00

Figure 10. Income Statement as of April 23

III. PRODUCT DIVERSIFICATION

The business met Springworks Incorporated to work with them for product diversification. Hiraya made another product line using sustainable and indigenous materials. Inspired by indigenous textiles like T'nalak, Hiraya looked for cheaper alternatives for the wallets' production (Lush, 2017). The business created Bukangliwayway and Takipsilim for the men's and women's wallets. The business picked the names to depict the colors that the sunrise and the sunset emits.

Hiraya bought Kraft Paper, Labeled Stickers, and Foam wrap for the packaging which totaled to Php 588.00. Hiraya's total capital for the product diversification is Php 27,488.00 and produced a total of 200 pieces. The supplier shouldered expenses for the three prototypes. The total production cost and packaging cost for the men's wallet is Php125.00 and Php150.00 for the women's wallet. The business added a 60% markup rate to the new products to sell them for Php200.00 (men's wallet) and Php240.00 (women's wallet). Below are some of the behind the scenes from the photoshoot:



Figure 11.1 & 11.2. Behind the scenes of the photoshoot for the product diversification



IV. FUTURE PLANS

Hiraya has two future plans for the business. First is the short-term planning, which involves the assessment of current budgets, pursuing more target markets, and anticipating present and future sales after 1-2 years. This will involve Hiraya's plan of diversifying products related to the theme or uniqueness of the pouch bags, which are now the wallets. The sales of the diversified products and the bags will also lead to more capital to be used for more products.

The CSR (Corporate Social Responsibility) of the business will continually aim to commit to the provided program of the LMO called "KPAP". The business can provide manpower, resources, and some finances to keep the program running. Hiraya still has no given responsibility for the "KPAP", but the business promises its efforts for the growth of the program as well as other future programs that will benefit the people in need.

The group will also liquidate its business by May 2021 and will close as a sole proprietorship. However, it will continue with a new business organization which is a partnership. As such, the business will continue to look for new partners and additional investors.

Furthermore, the group will also register its intellectual properties, patents, and trademarks for the business to have legal rights over its unique designs and products.

On the other hand, the long-term plans of Hiraya involve innovation, development, and expanding the market by getting the raw materials directly from local places like Bicol, Mindoro, and Aklan. By doing this, the group can directly help the locals and consider them as suppliers.

The business also wants to become known internationally by providing more suitable designs and creating more advertisements and proper marketing strategies which will use monetary bills and proper effort. Becoming internationally recognized will create more opportunities for the business to help and provide jobs not just for the Abaca farmers, but also for the general welfare of the marginalized and the needy, in particular, and promote the Philippine industry, in general.

V. ACKNOWLEDGEMENT

The business would like to show its appreciation to the following people:

First and foremost, Sir Generie M. Manuel, for helping and guiding the researchers through the process of doing this research and for sacrificing his time to give his comments and suggestions for the betterment of this paper.

To Ms. Maya Magiliman, for teaching her

students and providing enough learning materials to guide them all throughout the research process.

To Edward Sewing and Printing Services, for their time and patience to communicate with the managers through virtual and face-to-face meetings.

To Springworks Inc., for the time they offered to accommodate the group regarding the product diversification and Ms. Lara Dizon as the person they communicate with for the production of the product.

To Hwa Sin Print Corp., for the time they have contributed to the group regarding the tags to be put in the business' product diversification.

Hiraya would also like to express its appreciation to its customers for trusting its products and continuously supporting its small local business.

To the family and friends of the researchers, for the trust, they have for the business. Hiraya wouldn't have been able to reach this point without their endless support and guide throughout the entire operation of the business.

VI. REFERENCES

- BUSINESS REGISTRATION AND PERMITS. (n.d.). Department of Trade Industry.
<https://www.dti.gov.ph/negosyo/business-registration-and-permits/>
- Davidson, E. (2016). When to Choose Sole Proprietorship. Small Business - Chron.com.
<https://smallbusiness.chron.com/choose-sole-proprietorship-16793.html>
- Freedman, M. (2020). 22 Branches of Business Management. Business.com;
<https://www.business.com/articles/8-branches-of-business-management/>
- Kenton, W. (2020). Penetration Pricing. Investopedia.
<https://www.investopedia.com/terms/p/penetration-pricing.asp>
- Lush, E. (2017). T'nalak Weaving, Philippines — The Textile Atlas. The Textile Atlas.
<https://www.thetextileatlas.com/craft-stories/tnalak-weaving-philippines>
- Salary Data & Career Research Center (Philippines). (n.d.). PayScale.
<https://www.payscale.com/research/PH/Country=Philippines/Salary>
- Sara, A. (2016). 17 Things to Keep in Your Purse - College Fashion.
<https://www.collegefashion.net/college-life/17-thing-to-keep-in-your-purse/>
- Stark, A. (2019). 10 Skills Every Business Owner Should Have - Ako Stark - Medium. Medium;
<https://medium.com/@akostark/10-skills-every-business-owner-should-have-c3c882618eb8>
- Using social media to market your business: the basics | Business Queensland. (2016).
<https://www.business.qld.gov.au/running-business/marketing-sales/marketing-promotion/online-marketing/social-media/#~:text=Social%20media%20are%20internet%20services,for%20businesses%20of%20all%20sizes.&text=promote%20the%20name%20of%20your,about%20your%20goods%20and%20services>
- VanEeno, C. (2011). Minimalism in Art and Design: Concept, influences, implications and perspectives. Academic Journals.
<https://academicjournals.org/journal/JFSA/article-full-text-pdf/3A668BC6040>



Assessing the Marketability of BEU as a Loungewear Brand Producing Ethically-Made and Gender-Inclusive Clothing in the Philippines

BEU

Carlos Miguel G. Alonte, Rhiean Gabriel E. Bandola, Nicka Darlene D. Dela Vega, Kylene Nicole R. Lirio, Maria Angela A. Secillano, and Luigie Vondel D. Ventanilla
De La Salle University Integrated School, Biñan City, Laguna

Executive Summary: BEU is an ethical and gender-inclusive brand that aims to provide its customers with high-quality loungewear products promoting a more sustainable approach in terms of manufacturing and purchasing contemporary clothing pieces while striving for inclusivity through their brand’s motto “Be You” encouraging individuals to be who they are in the clothes they wear.

BEU’s products within the market are manufactured by an ethical business: Candid Clothing. The material utilized for the production is French Terry fabric that is sourced through Tailored Projects. One of the most notable advantages of BEU is its established marketing strategies, particularly the launch of its website, which is functional and well-designed given its capacity to ease and improve the process of communication between the brand and its customers. As a sole proprietor business, their starting capital of Php 73,140 was acquired through the financial contribution of BEU’s shareholders. The expenses and transactions made after the launching of the business for resources, manufacturing costs, and packaging expenses are managed thoroughly; including the projected and actual sales monitored monthly for a better understanding of the business’ operation and sales performance.

With BEU’s drive to prove and satisfy its customers with a quality product, improve and address common societal concerns as a social enterprise, advocate an idea of embracing one’s truest self, and establish a promising vision of becoming an ethical brand affiliated with outstanding plans, the business could highly provide a positive impact to the society from a global perspective.

Key Words: ethical; sustainable; gender-inclusivity; loungewear; local business

I. BUSINESS REGISTRATION AND ORGANIZATION

Last November 23, 2020, BEU has successfully accomplished its application forms for the corresponding government-issued permits required for instituting a business, particularly the DTI permit, Mayor’s permit, and BIR permit. One of the documents registered by BEU last November 22, 2020, is the DTI (Department of Trade and Industry) permit. Moreover, a government-issued permit from

the city government of Sta. Rosa, Laguna along with the BIR (Bureau of Internal Revenue) were registered and accomplished as well last November 23, 2020, for the fulfillment of requirements for BEU’s business operations.



Fig. 1. DTI Registration Permit

Fig. 2. Application for Mayor's Permit

Fig. 3 (a-c). BIR Application Form

Organization Chart



Fig. 4. Organizational Chart

BEU's organization is comprised of six different positions namely the Owner which is Ms. Angel Secillano, the Operations Manager which is

Ms. Nicka Dela Vega, Mr. Rhiean Bandola as the Financial Manager, Mr. Carlos Alonte as the Resource Manager, Ms. Kylene Nicole Lirio as the Marketing Manager, and Mr. Vondel Ventanilla as BEU's Advertising Manager.

II. BUSINESS PLAN IMPLEMENTATION

II.1. Production

II.1.1. ACQUISITION OF RAW MATERIALS AND OTHER SUPPLIES

For the production of our loungewear products, BEU entrusted the supply of fabric materials to Tailored Projects— a trusted clothing supplier here in the Philippines that specializes in garment manufacturing. Candid Clothing, on the other hand, was selected for the manufacturing of our products given it being one of the few businesses here in the country that embraces ethicality within the industry. For the packaging, the business decided to go with an eco-friendly hand-sewn organza tote bag. Raw materials for its production were sourced from Divisoria Market and the production itself was done in Efren's Tailoring, Biñan, Laguna. Other supplies such as clothing tags and labels were obtained from JM Prints and Designs located in Manila

II.1.2. PROCESSING OF RAW MATERIALS AND OTHER SUPPLIES

Attaining fabric supplies holds a waiting period of 1-2 weeks. For the manufacturing itself, approximately 4-5 weeks must be taken into account. On the other hand, for the packaging, a waiting period of 2 weeks must be considered and for the clothing tags, BEU acquired a total waiting period of 4 days from JM Prints and Designs.

II.1.3. PROCESSING THE PRODUCTION OF ITEMS

After the process of completing all the supplies and raw materials, the production of prototypes follows along with the changes to be made in preparation for the mass production itself. According to the aforementioned manufacturer, BEU needs to allow and consider estimation of 4-5 weeks in total for the complete processing of 80 loungewear products.

II.1.4. QUALITY CONTROL

BEU seeks to ensure that the products are well done and the condition is maintained and improved for customer satisfaction. With that being said, the finished products are then delivered to Sta.

Rosa, Laguna where the process of reviewing and evaluating the products take place to achieve the standards and quality requirements of BEU.

II.1.5. PROCESSING OF ORDERS

According to Sebjanic (2018), having websites help sell and promote services and products 24/7. Considering the aforementioned, BEU decided to launch its own website: www.wearbeu.com, where all of the orders and transactions would take place for a faster and simpler way of tracking orders and updating inventories considering that the website is connected to the email account of the business itself. In terms of the payments, transactions are settled through GCash or bank-to-bank transfer. Customers could also settle their payments by opting for Cash on Delivery for a convenient and worry-free process of paying for the ordered products.

II.2. Inventory Management

As stated, it takes a total of 4-5 weeks in acquiring a total of 80 finished loungewear products. Given that, BEU decided to have inventory control once the business itself would reach 70% of its sales from the total projected sales of the loungewear products offered within the market. Raw materials, along with the other necessary supplies mentioned, would then be restored and replaced for the next cycle of production.

II.3 Marketing

Product

Loungewear became BEU’s official product and the manufacturing process involves local tailors and seamstresses from Manila who specialize in producing ethically made products. The fabric that would be utilized with the production is specifically french terry which is said to be one of the most commonly used fabrics when producing loungewear products. In terms of the specifications, various colors and sizes are decided to be offered specifically Sky, Sand, Moss, and Mud available in Sizes 1, 2, and 3.

For the design, BEU has set a minimalistic design to depict what would best fit all given the advocacy for gender inclusivity. Embroidered on the upper left corner of the loungewear is the phrase “be you” which helps strongly emphasize what the business would want the market to support and embrace.

THE GAIA COLLECTION



Fig. 5. BEU’s Flagship Product (The GAIA Collection)

Price

For the pricing profile of BEU, a cost-plus pricing strategy was used along with the established markup rate of 35%. BEU has established a division of costs for the total expenses made for manufacturing and acquiring fabric supplies.

Provided below are the computations made by the business itself to identify and generate the most appropriate and reasonable estimation of costs and selling price.

SWEATER

Table 1: Pricing Profile for Sweater

	Cost
Materials	Php 354.375
Manufacturing	Php 139.50
Packaging	Php 48.25
Tags	Php 2.50
Etiketa	Php 7.90
Delivery Costs	Php 100
TOTAL (Initial Price)	Php 652.525

Table 2: Selling Price for Sweater

Initial Price	Mark-up	Selling Price
Php 652.525	35%	880.91 ≈ 899

SWEATPANTS

Table 3: Pricing Profile for Sweatpants

	Cost
Materials	Php 590.625
Manufacturing	Php 232.50
Packaging	Php 48.25
Tags	Php 2.50
Etiketa	Php 7.90
Delivery Costs	Php 100
TOTAL (Initial Price)	Php 981.775

Table 4: Selling Price for Sweatpants

Initial Price	Mark-up	Selling Price
Php 981.775	35%	1325.40 ≈ 1299



3RD DLSU SENIOR HIGH SCHOOL RESEARCH CONGRESS

BUSINESS CONCEPT BAZAAR

Place

BEU's products are sold through online social media and commerce platforms. The business utilizes Facebook and Instagram in terms of promotional and marketing while officially selling its products through its own website which is customized and created in order to offer an easy transaction and shopping experience for the customers. The stocks and inventory on the other hand are in their headquarters in 4026, Block 3 Lot 1 & 2, Barangay Labas, Buena Perlas 2 Subdivision, City of Santa Rosa, Laguna, where they sanitize, pack, and ship their products.

Promotion

BEU extended its marketing strategies by truthfully advocating gender-inclusivity by supporting the LGBTQIA++ Community through videos and publication materials posted on Facebook and Instagram. In just a few months BEU has accumulated over 1,090 followers and established an approachable image to the business' future customers through interactive games via Instagram Story games and digital magazines.

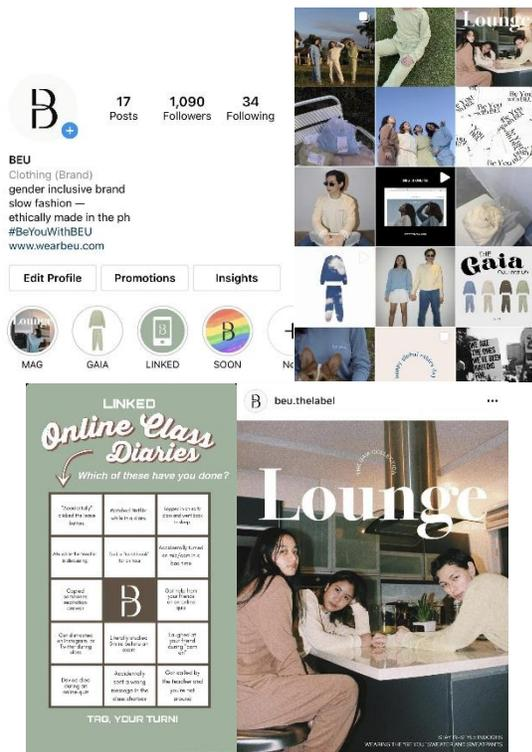

Fig. 6 (a-d). Instagram Account and Publication Materials of BEU

In terms of analytics and insights from the publication materials and posts, BEU has reached more than 7,000 impressions and engaged in 2,314

account activities which includes 2,054 profile visits and 260 website taps from November 12 to December 11 of 2020. Highlighting BEU's top post which is about its name "BEU" got over 4,082 reach and 442 interactions. The post acquired 447 likes, 16 comments, 14 shares, and 29 saves on Instagram.

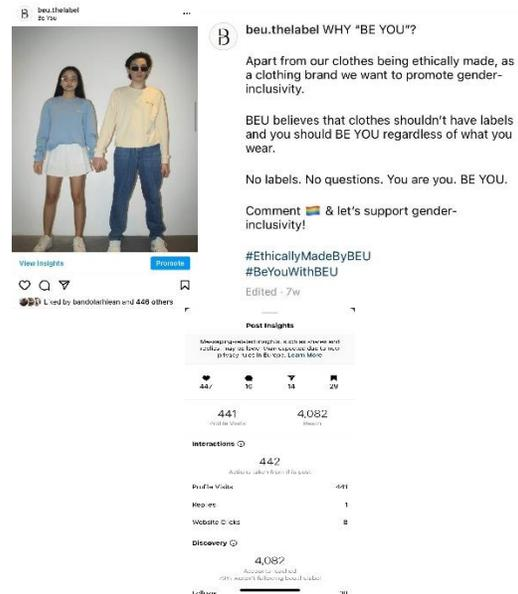

Fig. 7 (a-c). Instagram Account and Post Insights

BEU became the very first business within the institution to launch its own website. With the launch of the business's website and its own domain, BEU automated data collections, sales emails, post sales emails, events, and customer lifecycle.

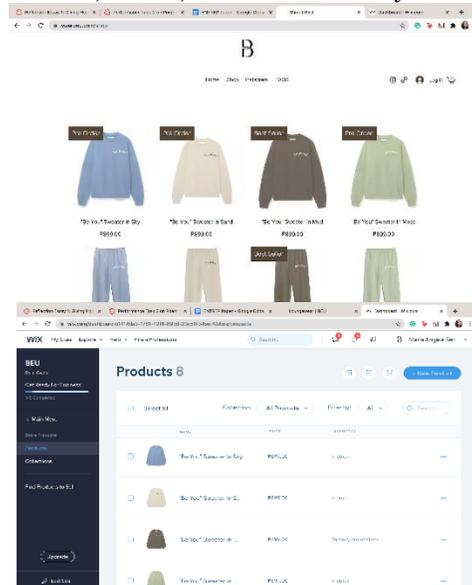

Fig. 8 (a-b). BEU's Official Website (<https://www.wearbeu.com/>)

In shooting their products, BEU shot the clothing pieces outdoors which symbolizes their first collection's inspiration: the earth. A fun and effortless personality are given to the clothes by shooting candid photos. In addition to that, BEU also shot the clothes paired with different clothing pieces such as pairing the Be You Sweater in Sky with a plain white tennis skirt for the customers to see how BEU's clothing pieces can be versatile and styled in many ways.



Fig. 9 (a-d). Sample images from the Official Product Shoot

II.4 Human Resources

Six proponents, supervise BEU and its overall progress. Ms. Angel Secillano oversees the overall success of the company venture as the owner of BEU. On the other hand, as the business company's financial manager, Mr. Rhiean Bandola is accountable for controlling its economic and financial development. Ms. Nicka Dela Vega, as the operational manager of the BEU, is responsible for controlling the production as well as the output of the goods of the business venture. As the human resources manager, Mr. Carlos Alonte is the one responsible for monitoring the tasks assigned and carried out by each proponent. Finally, as the advertising and marketing manager respectively, Mr. Vondel Ventanilla and Ms. Kylene Lirio are the managers assigned in initiating various strategies and plans for promoting the overall state of the business venture and its products.

Aside from this, the business has also chosen to enlist the product's manufacturer: Candid Clothing, an ethical company specializing in manufacturing sweaters and sweatpants. Moreover, the business opted to choose two (2) more manufacturers as well to aid the production of labels: JM Prints and Designs, and packaging: Efren's Tailoring, which is used to pack and complete the overall appearance of the products.



Fig. 10 (a-d). BEU's clothing tags and packaging

A. FINANCE (Projected vs. Actual)

Table 5. Projected Sales for November 2020

BEU				
November 2020 (Actual)				
Product	Quantity	Price	Per Quantity	Sales
"Be You" Sweater in SKY, Size 1	1	899		899
"Be You" Sweater in SKY, Size 2	2	899		1,798
"Be You" Sweater in SAND, Size 1	2	899		1,798
"Be You" Sweater in SAND, Size 2	1	899		899
"Be You" Sweater in MOSS, Size 1	1	899		899
"Be You" Sweater in MOSS, Size 2	1	899		899
"Be You" Sweater in MUD, Size 1	1	899		899
"Be You" Sweater in MUD, Size 2	1	899		899
"Be You" Sweatpants in SKY, Size 1	1	1,299		1,299
"Be You" Sweatpants in SKY, Size 2	2	1,299		2,598
"Be You" Sweatpants in SKY, Size 3		1,299		
"Be You" Sweatpants in SAND, Size 1	2	1,299		2,598
"Be You" Sweatpants in SAND, Size 2	1	1,299		1,299
"Be You" Sweatpants in SAND, Size 3		1,299		
"Be You" Sweatpants in MOSS, Size 1	1	1,299		1,299
"Be You" Sweatpants in MOSS, Size 2	1	1,299		1,299
"Be You" Sweatpants in MOSS, Size 3		1,299		
"Be You" Sweatpants in MUD, Size 1	1	1,299		1,299
"Be You" Sweatpants in MUD, Size 2	1	1,299		1,299
"Be You" Sweatpants in MUD, Size 3		1,299		



Table 6. Actual Sales for November 2020

BEU				
November 2020 (Projected)				
Product	Quantity	Price Per	Quantity	Sales
"Be You" Sweater in SKY, Size 1	1	899		899
"Be You" Sweater in SKY, Size 2		899		
"Be You" Sweater in SAND, Size 1	2	899		1,798
"Be You" Sweater in SAND, Size 2		899		
"Be You" Sweater in MOSS, Size 1	1	899		899
"Be You" Sweater in MOSS, Size 2	1	899		899
"Be You" Sweater in MUD, Size 1	1	899		899
"Be You" Sweater in MUD, Size 2	1	899		899
"Be You" Sweatpants in SKY, Size 1	1	1,299		1,299
"Be You" Sweatpants in SKY, Size 2	1	1,299		1,299
"Be You" Sweatpants in SKY, Size 3		1,299		
"Be You" Sweatpants in SAND, Size 1	1	1,299		1,299
"Be You" Sweatpants in SAND, Size 2	1	1,299		1,299
"Be You" Sweatpants in SAND, Size 3		1,299		
"Be You" Sweatpants in MOSS, Size 1	1	1,299		1,299
"Be You" Sweatpants in MOSS, Size 2	1	1,299		1,299
"Be You" Sweatpants in MOSS, Size 3		1,299		
"Be You" Sweatpants in MUD, Size 1	1	1,299		1,299
"Be You" Sweatpants in MUD, Size 2	1	1,299		1,299
"Be You" Sweatpants in MUD, Size 3		1,299		

Table 7. Total Sales, COGS, and Profit for November 2020

November	
SALES	Php 21,980
COST OF GOODS SOLD	Php 16,343
PROFIT	Php 5,637

For the month of BEU's launching last November 2020, the business has acquired 10 sets of pre-ordered loungewear products amounting to P21,980. To this, a total of Php 5,637 for the profit was initially acquired by BEU for the first 10 sets of orders.

Table 8. Projected Sales for December 2020

BEU				
December 2020 (Actual)				
Product	Quantity	Price Per	Quantity	Sales
"Be You" Sweater in SKY, Size 1	1	899		899
"Be You" Sweater in SKY, Size 2	2	899		1,798
"Be You" Sweater in SAND, Size 1	3	899		2,697
"Be You" Sweater in SAND, Size 2	1	899		899
"Be You" Sweater in MOSS, Size 1	5	899		4,495
"Be You" Sweater in MOSS, Size 2	3	899		2,697
"Be You" Sweater in MUD, Size 1	1	899		899
"Be You" Sweater in MUD, Size 2	5	899		4,495
"Be You" Sweatpants in SKY, Size 1		1,299		
"Be You" Sweatpants in SKY, Size 2		1,299		
"Be You" Sweatpants in SKY, Size 3		1,299		
"Be You" Sweatpants in SAND, Size 1		1,299		
"Be You" Sweatpants in SAND, Size 2		1,299		
"Be You" Sweatpants in SAND, Size 3		1,299		
"Be You" Sweatpants in MOSS, Size 1		1,299		
"Be You" Sweatpants in MOSS, Size 2	1	1,299		1,299
"Be You" Sweatpants in MOSS, Size 3	1	1,299		1,299
"Be You" Sweatpants in MUD, Size 1		1,299		
"Be You" Sweatpants in MUD, Size 2		1,299		
"Be You" Sweatpants in MUD, Size 3	2	1,299		2,598

Table 9. Actual Sales for December 2020

BEU				
December 2020 (Projected)				
Product	Quantity	Price Per	Quantity	Sales
"Be You" Sweater in SKY, Size 1	2	899		1,798
"Be You" Sweater in SKY, Size 2	1	899		899
"Be You" Sweater in SAND, Size 1	3	899		2,697
"Be You" Sweater in SAND, Size 2	4	899		3,596
"Be You" Sweater in MOSS, Size 1	2	899		1,798
"Be You" Sweater in MOSS, Size 2	1	899		899
"Be You" Sweater in MUD, Size 1	1	899		899
"Be You" Sweater in MUD, Size 2	1	899		899
"Be You" Sweatpants in SKY, Size 1	1	1,299		1,299
"Be You" Sweatpants in SKY, Size 2		1,299		
"Be You" Sweatpants in SKY, Size 3		1,299		
"Be You" Sweatpants in SAND, Size 1		1,299		
"Be You" Sweatpants in SAND, Size 2		1,299		
"Be You" Sweatpants in SAND, Size 3		1,299		
"Be You" Sweatpants in MOSS, Size 1	1	1,299		1,299
"Be You" Sweatpants in MOSS, Size 2	1	1,299		1,299
"Be You" Sweatpants in MOSS, Size 3	1	1,299		1,299
"Be You" Sweatpants in MUD, Size 1	1	1,299		1,299
"Be You" Sweatpants in MUD, Size 2	2	1,299		2,598
"Be You" Sweatpants in MUD, Size 3		1,299		

Table 10. Total Sales, COGS, and Profit for December 2020

December	
SALES	Php 24,075
COST OF GOODS SOLD	Php 17,630.125
PROFIT	Php 6,444.875

Last December 2020, BEU acquired a total of 25 orders; 21 orders for the sweaters and 4 orders for the sweatpants respectively, a sale amounting to Php 24,075 with a profit of Php 6,444.875 was obtained by BEU for the whole month of December.

Table 11. Projected Sales for January 2021

BEU				
January 2021 (Projected)				
Product	Quantity	Price Per	Quantity	Sales
"Be You" Sweater in SKY, Size 1		899		
"Be You" Sweater in SKY, Size 2	1	899		899
"Be You" Sweater in SAND, Size 1	1	899		899
"Be You" Sweater in SAND, Size 2		899		
"Be You" Sweater in MOSS, Size 1		899		
"Be You" Sweater in MOSS, Size 2		899		
"Be You" Sweater in MUD, Size 1	1	899		899
"Be You" Sweater in MUD, Size 2		899		
"Be You" Sweatpants in SKY, Size 1		1,299		
"Be You" Sweatpants in SKY, Size 2	1	1,299		1,299
"Be You" Sweatpants in SKY, Size 3		1,299		
"Be You" Sweatpants in SAND, Size 1	1	1,299		1,299
"Be You" Sweatpants in SAND, Size 2		1,299		
"Be You" Sweatpants in SAND, Size 3		1,299		
"Be You" Sweatpants in MOSS, Size 1		1,299		
"Be You" Sweatpants in MOSS, Size 2		1,299		
"Be You" Sweatpants in MOSS, Size 3		1,299		
"Be You" Sweatpants in MUD, Size 1	1	1,299		1,299
"Be You" Sweatpants in MUD, Size 2		1,299		
"Be You" Sweatpants in MUD, Size 3		1,299		



Table 12. Actual Sales for January 2021

BEU				
January 2021 (Actual)				
Product	Quantity	Price Per	Quantity	Sales
"Be You" Sweater in SKY, Size 1	1	899		899
"Be You" Sweater in SKY, Size 2		899		
"Be You" Sweater in SAND, Size 1	1	899		899
"Be You" Sweater in SAND, Size 2		899		
"Be You" Sweater in MOSS, Size 1		899		
"Be You" Sweater in MOSS, Size 2		899		
"Be You" Sweater in MUD, Size 1	1	899		899
"Be You" Sweater in MUD, Size 2		899		
"Be You" Sweater in SKY, Size 1	1	1,299		1,299
"Be You" Sweater in SKY, Size 2		1,299		
"Be You" Sweater in SKY, Size 3		1,299		
"Be You" Sweater in SAND, Size 1		1,299		
"Be You" Sweater in SAND, Size 2		1,299		
"Be You" Sweater in SAND, Size 3		1,299		
"Be You" Sweater in MOSS, Size 1		1,299		
"Be You" Sweater in MOSS, Size 2		1,299		
"Be You" Sweater in MOSS, Size 3		1,299		
"Be You" Sweater in MUD, Size 1	1	1,299		1,299
"Be You" Sweater in MUD, Size 2		1,299		
"Be You" Sweater in MUD, Size 3		1,299		

Table 13. Total Sales, COGS, and Profit for January 2021

January	
SALES	Php 5,295
COST OF GOODS SOLD	Php 3,921.125
PROFIT	Php 1,373.875

For the month of January 2021, BEU encountered an off-peak period with the actual sales recorded. To this, actual sales obtained from a total of 5 ordered items amounted to Php 5,295 resulting in a total of Php 1,373.875 profit.

Table 14. Projected Sales for February 2021

BEU				
February 2021 (Projected)				
Product	Quantity	Price Per	Quantity	Sales
"Be You" Sweater in SKY, Size 1	1	899		899
"Be You" Sweater in SKY, Size 2	2	899		1,798
"Be You" Sweater in SAND, Size 1		899		
"Be You" Sweater in SAND, Size 2		899		
"Be You" Sweater in MOSS, Size 1		899		
"Be You" Sweater in MOSS, Size 2		899		
"Be You" Sweater in MUD, Size 1	1	899		899
"Be You" Sweater in MUD, Size 2	1	899		899
"Be You" Sweater in SKY, Size 1	1	1,299		1,299
"Be You" Sweater in SKY, Size 2		1,299		
"Be You" Sweater in SKY, Size 3		1,299		
"Be You" Sweater in SAND, Size 1		1,299		
"Be You" Sweater in SAND, Size 2		1,299		
"Be You" Sweater in SAND, Size 3	1	1,299		1,299
"Be You" Sweater in MOSS, Size 1		1,299		
"Be You" Sweater in MOSS, Size 2		1,299		
"Be You" Sweater in MOSS, Size 3		1,299		
"Be You" Sweater in MUD, Size 1	1	1,299		1,299
"Be You" Sweater in MUD, Size 2	2	1,299		2,598
"Be You" Sweater in MUD, Size 3	1	1,299		1,299

Table 15. Actual Sales for February 2021

BEU				
February 2021 (Actual)				
Product	Quantity	Price Per	Quantity	Sales
"Be You" Sweater in SKY, Size 1	1	899		899
"Be You" Sweater in SKY, Size 2		899		
"Be You" Sweater in SAND, Size 1	1	899		899
"Be You" Sweater in SAND, Size 2	1	899		899
"Be You" Sweater in MOSS, Size 1	1	899		899
"Be You" Sweater in MOSS, Size 2	1	899		899
"Be You" Sweater in MUD, Size 1	1	899		899
"Be You" Sweater in MUD, Size 2		899		
"Be You" Sweater in SKY, Size 1	1	1,299		1,299
"Be You" Sweater in SKY, Size 2		1,299		
"Be You" Sweater in SKY, Size 3		1,299		
"Be You" Sweater in SAND, Size 1	1	1,299		1,299
"Be You" Sweater in SAND, Size 2	1	1,299		1,299
"Be You" Sweater in SAND, Size 3		1,299		
"Be You" Sweater in MOSS, Size 1	1	1,299		1,299
"Be You" Sweater in MOSS, Size 2	1	1,299		1,299
"Be You" Sweater in MOSS, Size 3		1,299		
"Be You" Sweater in MUD, Size 1	1	1,299		1,299
"Be You" Sweater in MUD, Size 2	1	1,299		1,299
"Be You" Sweater in MUD, Size 3		1,299		

Table 16. Total Sales, COGS, and Profit for February 2021

February	
SALES	Php 14,487
COST OF GOODS SOLD	Php 10,787.575
PROFIT	Php 3,699.425

Last February 2021, BEU decided to improve its social media engagement given that it would be beneficial for the sales development due to the significant drop of sales last January 2021. To this, BEU established certain marketing strategies and provided multiple publication materials to further acquire and increase its sales by the end of the month. Fortunately, an amount of Php 14,487 was recorded for the sales last February which is beyond the stated projected sales of Php 12,289. The aforementioned total sales resulted in a total profit of Php 3,699.42.



Table 17. Projected Sales for March 2021

BEU				
March 2021 (Projected)				
Product	Quantity	Price Per	Quantity	Sales
"Be You" Sweater in SKY, Size 1	2	899		1,798
"Be You" Sweater in SKY, Size 2	1	899		899
"Be You" Sweater in SAND, Size 1		899		
"Be You" Sweater in SAND, Size 2		899		
"Be You" Sweater in MOSS, Size 1	1	899		899
"Be You" Sweater in MOSS, Size 2		899		
"Be You" Sweater in MUD, Size 1		899		
"Be You" Sweater in MUD, Size 2		899		
"Be You" Sweatpants in SKY, Size 1		1,299		
"Be You" Sweatpants in SKY, Size 2		1,299		
"Be You" Sweatpants in SKY, Size 3		1,299		
"Be You" Sweatpants in SAND, Size 1		1,299		
"Be You" Sweatpants in SAND, Size 2		1,299		
"Be You" Sweatpants in SAND, Size 3		1,299		
"Be You" Sweatpants in MOSS, Size 1		1,299		
"Be You" Sweatpants in MOSS, Size 2		1,299		
"Be You" Sweatpants in MOSS, Size 3		1,299		
"Be You" Sweatpants in MUD, Size 1	1	1,299		1,299
"Be You" Sweatpants in MUD, Size 2		1,299		
"Be You" Sweatpants in MUD, Size 3	1	1,299		1,299

Table 18. Actual Sales for March 2021

BEU				
March 2021 (Actual)				
Product	Quantity	Price Per	Quantity	Sales
"Be You" Sweater in SKY, Size 1	2	899		1798
"Be You" Sweater in SKY, Size 2		899		
"Be You" Sweater in SAND, Size 1		899		
"Be You" Sweater in SAND, Size 2	2	899		1798
"Be You" Sweater in MOSS, Size 1		899		
"Be You" Sweater in MOSS, Size 2		899		
"Be You" Sweater in MUD, Size 1	2	899		1798
"Be You" Sweater in MUD, Size 2		899		
"Be You" Sweatpants in SKY, Size 1		1,299		
"Be You" Sweatpants in SKY, Size 2		1,299		
"Be You" Sweatpants in SKY, Size 3		1,299		
"Be You" Sweatpants in SAND, Size 1	1	1,299		1299
"Be You" Sweatpants in SAND, Size 2		1,299		
"Be You" Sweatpants in SAND, Size 3		1,299		
"Be You" Sweatpants in MOSS, Size 1		1,299		
"Be You" Sweatpants in MOSS, Size 2		1,299		
"Be You" Sweatpants in MOSS, Size 3		1,299		
"Be You" Sweatpants in MUD, Size 1		1,299		
"Be You" Sweatpants in MUD, Size 2		1,299		
"Be You" Sweatpants in MUD, Size 3		1,299		

Table 19. Total Sales, COGS, and Profit for March 2021

March	
SALES	Php 6,693
COST OF GOODS SOLD	Php 4,896.925
PROFIT	Php 1,796.075

Due to the unavailability of other items that are already sold out by the beginning of March, it is

expected by the business itself that the possibility of experiencing another drop in sales would highly be possible. The actual sales for March amounted to Php 6,693 with a total profit of Php 1,796.075. With the aforementioned factor for the sudden drop in sales, BEU has decided to manufacture and restock some of the best-selling items from its loungewear products. A total number of 36 items is expected to be offered within the market by the start of April 2021.

Table 20. Income Statement for months ended November 2020 to March 2021

BEU	
Income Statement	
For the months ended November 2020 to March 2021	
Sales	72,530.00
Cost of Sales	53,578.75
Gross Income	18,951.25
Net Income	18,951.25

For the overall sales acquired by BEU for the months ended **November 2020 to March 2021**, a total sale of **Php 72, 530** was successfully attained by the business itself resulting in an amount of **Php 18, 951.25** for the overall profit.

III. PRODUCT DIVERSIFICATION

The business's new collection will be called "BEU Essentials" which consists of new loungewear designs: a hoodie in neutral colorways White and Black. The inspiration for this collection is to provide a more versatile loungewear collection through its comfortability and style. The design of the product incorporates BEU's online advocacy called the "Be You Movement" where people may empower themselves or other people through clothing.



Fig. 11. BEU Essentials Actual Product (The "BYM" Hoodie)

In BEU's second collection, the business will also incorporate a surgical facemask which is FDA-approved with the text "stay safe & be you" and "please dispose of me properly" to symbolize the importance of wearing a mask and BEU's branding, also making sure that people will dispose the mask

properly in order to reduce the risk of negative environmental impacts.



Fig. 12. *BEU Essentials Actual Product (Stay Safe & Be You FDA Approved Mask)*

Supporting small and local businesses is one of the few ways on how to be sustainable because these brands use fewer resources in manufacturing products and you will also help a small business owner’s dream. BEU collaborated with Astrid By J which is an online jewelry shop on Instagram specializing in handmade beaded accessories owned by a college student. BEU reached out to the mentioned small business to create a mask chain which comes very handy when you want to prevent your mask from touching other surfaces when you would like to remove it. There are two colorways for the product: a full rainbow chain with the text “Be You” and a mostly white chain with a few rainbow beads on the side. Both designs pay homage to the LGBTQIA++ Flag.

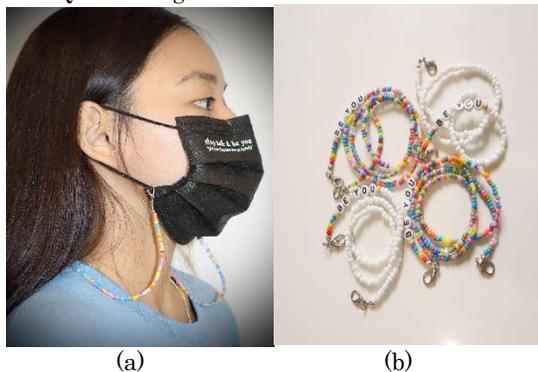

Fig. 13 (a-b). *BEU Essentials Actual Product (“BEUxAstridByJ” Handmade Mask Chain)*

General Partnership Agreement

BEU (@beu.thelabel), owned by Angel Secillano, residing at 4026, Block 3 Lot 1 & 2, Buena Perlas 2 Subdivision, City of Santa Rosa, Laguna and **astrid by j (@astrid.byj)**, owned by Janna Marithé Tañedo, residing at Viera Residences Scout Tuason, Quezon City hereinafter referred to as the “Partners” agree as follows:

The Partners voluntarily associate themselves together as general partners as astrid by j will supply BEU with their products and services and in exchange BEU and its owner, will provide monetary and marketing support.

The name of the partnership shall be “BEU x astrid by j” which will be used for publication materials and promotional purposes. This partnership will be held through online commerce and social media platforms utilized by both partners.

BEU and astrid by j agrees to fulfill the following terms and conditions:

1. BEU to pay the amount of Php 3,500.00 to astrid by j as payment for the 100 pieces of products the partner will provide.
2. BEU will be posting 5 Instagram Posts and 5 Instagram stories featuring astrid by j
3. Angel Secillano, owner of BEU and online content creator, will be featuring astrid by j through the following marketing and promotional supplements:
 - a. 2 Instagram Photos posted on Instagram Feed open for cross posting
 - b. 5 Instagram Stories mentioning @astrid.byj
 - c. 2 Youtube Video mentions through the channel named Angel Secillano
4. BEU and Angel Secillano will be hosting a giveaway featuring astrid by j
 - a. BEU shall include in the mechanics the mandatory following and sharing of @astrid.byj
 - b. Astrid by j shall share the publication materials of the giveaway
5. Astrid by j shall share all publication materials of the collaboration in their Instagram Story
6. Astrid by j shall post 2 Instagram Feed posts and 5 Instagram Stories featuring @beu.thelabel

This instrument contains the sole agreement of the parties relating to their Partnership and correctly sets forth the rights, duties and obligations of each to the other in connection with is as of its date. Both parties agree that unfulfillment of the terms and conditions stated above shall be in exchange for a Php 5,000 fee.

Signed By:

Angel Secillano
Owner of BEU

Janna Marithé Tañedo
Owner of astrid by j

Date Signed: March 20, 2021

Date Signed: March 19, 2021

Fig. 14 . *General Partnership Agreement of BEU and Astrid By J*

IV. FUTURE PLANS

IV.1 Ethicality And Sustainability

Traditionally, Filipinos have followed a ‘*tiangge*’ culture (a Filipino term for a flea market or bazaar) but since the items sold at these retail spaces are not frequently updated compared with fast fashion retail outlets, Filipinos happily embrace this invasion. *Pinoys* would also rather buy upscale and imported brands rather than locally-produced clothing and accessories found at *tiangges* simply because imported fashion is seen as ‘cooler’ and is believed to be of better quality compared to local finds. The number of garments shopped by an average consumer from these global brands grew by 60% each year from 2000 to 2014 alone (Perez, 2019).

With this, BEU would like to expand its horizons as an ethical brand. BEU will continue to



develop its brand, grow within the community they are in, and inform more Filipinos about the importance of supporting local and small businesses, as well as the positive impacts of doing so.

IV.2 Products

Fashion is undetermined, meaning there will always be new ways on how a brand like BEU can improve its designs and create more innovative products. One of the business's proposed products is a tote bag made out of PVC and recycled bubble wraps. BEU noticed that many businesses nowadays use bubble wraps to transport the corresponding products offered from one place to another in order to guarantee protection. However, bubble wraps can give off irritating vapors that may cause breathing problems if inhaled and not properly disposed of.

An upcoming product will be BEU's collaboration with a local business called Separi Wear for a Zero Waste Collection which will utilize BEU's fabric scraps and turning them into new clothing pieces such as Terry Block Knit Tops manufactured by Separi Wear. This will help the brand work with more businesses and also reduce the brand's wastes.

IV.3 Public Relations and Advocacy

For BEU's second release, the business will be introducing the "Be You Movement" which refers to the advocacy of promoting gender inclusivity and equality here in the Philippines. Clothing and fashion have always been an instrument for each individual to express themselves and through BEU it will be possible for individuals to show who they are with the clothes they wear without the judgment of society, empowering them to live a life with confidence.

Included in BEU's advocacy are several campaigns which are allied to its movement. Through the presence of several influencers online who are members of the LGBTQIA++ Community, BEU will be conducting a series of interviews that talks about how these people are empowering others online by showing their own true colors. The business will also allot several pieces from its collection which will be sent as Public Relation (PR) Packages for creators online whom the business thinks would greatly contribute to empowering and inspiring individuals through its established platform. With the presence of these campaigns, BEU will extend its marketing strategies and make a difference within its community.

V. ACKNOWLEDGEMENT

The research proponents would like to acknowledge their corresponding parents namely Mr. and Mrs. Alonte, Mr. and Mrs. Bandola, Mr. and Mrs. Dela Vega, Mr. and Mrs. Lirio, Mr. and Mrs. Secillano, and Mr. and Mrs. Ventanilla, with their full support and trust in providing a starting capital for their business venture. Nevertheless, the parents did not only provide financial support but also offered certain strategies and recommendations with regards to how the business would be successfully managed and operated. With that said, the success that BEU had achieved would not be possible without their family serving as one of the business venture's backbones.

VI. REFERENCES/APPENDICES

- Sebjanic, S. (2018, January 17). 25 Reasons Why Small Businesses Need A Website. Nomiscom WebDesign. <https://nomiscomwebdesign.eu/why-small-businesses-need-a-website/>
- Perez, D. (2019, March 17). How Fast Fashion Invaded the Philippines Retail Market. Eco Warrior Princess. https://ecowarriorprincess.net/2019/03/how-fast-fashion-invaded-philippines-retail-market/?fbclid=IwAR3qoxAqFt0JVRvk1w_dqvZru5dZybeEQUjsLwhUeGcKWajKkzHjsFe1gJs.



Kargaen



Trishia Emilia L. Belarmino, Raphael Angelo Buquiz, Paul Alfred U. Diaz,
Edilberto II L. Tamis, and Angelina Isabelle S. Tejada
De La Salle University Integrated School, Biñan City, Laguna

Executive Summary: Kargaen was formed last 2020. From supporting local products to being an advocate of raising awareness on indigenous people, it was able to create a product that helps both. Since they were into helping the indigenous people, selling bags was one of the many helps that Kargaen pursued to promote the aesthetic value of Inabel, a fabric from Ilocos, on modern-designed handbags. What sets Kargaen apart from other products is having a completely customizable bag that is reversible where the fabric, Inabel, is visible on its covert side. The General Manager, Trishia Belarmino is in charge of the continuous growth of Kargaen as Angelina Tejada, Operations Manager, and Raphael Buquiz, Financial Manager, aid her. With the amount of effort both EG Tamis, and Paul Diaz brought to the table, the operation of the venture flowed more smoothly. So far, the bags that were sold touched both a modern and vintage look. This information helped Kargaen innovate a different shape of tote bags in order to compete with other bag sellers. Every bag has its purpose and use, so it's hard to distinguish their weak links. For the start-up capital of the business, every partner-member had contributed P5,000.00 each that amounted to a total of 25,000.00. Right after reaching breakeven, the members have agreed to get back their contribution and continue selling the rest of the inventory until it reaches its closure.

Key Words: tote; handbag; trendy; reversible; inabel

I. BUSINESS REGISTRATION AND ORGANIZATION

Sole proprietorship is the simplest business form under which one can operate a business (Fay, 1998). Kargaen operated as a sole proprietorship with minimal start-up capital of Php 25,000.00 and few personnel to initially operate. Lastly, this type of business was adopted as it was characterized by a fast decision-making process since the owner was tasked to mainly direct the business operations.

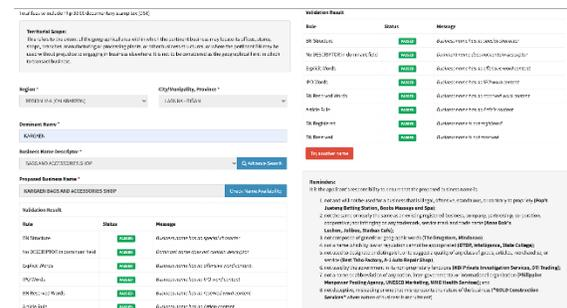

Figure 1. DTI Form



3RD DLSU SENIOR HIGH SCHOOL RESEARCH CONGRESS

BUSINESS CONCEPT BAZAAR

APPLICATION FORM FOR BUSINESS PERMIT
TAX YEAR **2020-2021**
CITY/MUNICIPALITY **Biñan, Laguna**

No. _____

INSTRUCTIONS:
1. Provide accurate information and print legibly to avoid delays. Incomplete application form will be returned to the applicant.
2. Ensure that all documents attached to this form (if any) are complete and properly filed out.

APPLICANT SECTION

1. BASIC INFORMATION

New Renewal Mode of Payment : Annually Semi Annually Quarterly

Date of Application: _____ DTI/SEC/CDA Registration No.: _____
TIN No.: _____ Tax Payer Category: Large Medium Small Micro

Type of Business: Single Partnership Corporation Cooperative
Amendment: From Single Partnership Corporation Corporation
To Single Partnership Corporation

Are you enjoying tax incentive from any Government Entity? Yes No

Please specify the entity? Local Investment Provincial PEZA

Name of Taxpayer / Registrant
Last Name: **Tejada** First Name: **Angelina Isabelle** Middle Name: **Soneja**
Business Name: **Kargaen**
Trade name/ Franchise: _____

2. OTHER INFORMATION

Business Address: (e.g. Street, Barangay, Municipality, Province)
Biñan, Laguna
Postal Code: **4024** Email Address: **eco.kargaen@gmail.com**
Telephone No.: _____ Mobile No.: _____

Owner's Address: (e.g. Street, Barangay, Municipality, Province)
Southpoint Subdivision, Pulò Cabuyao, Laguna
Postal Code: **4025** Email Address: **angelina_isabelle_tejada@dlsu.edu.ph**
Telephone No.: _____ Mobile No.: **09272447177**

In case of emergency, provide name of contact person: **Trishia Emilia L. Belarmino**
Telephone/Mobile No.: **09178303196** Email Address: **trishibelarmino3.tb@gmail.com**
Business Area (in sq. m.): _____ Total No. of Employees in Establishment: **6** No. of Employees Residing within LGU: _____

Note: Fill Up Only If Business Place is Rented
Lessor's Full Name: _____
Lessor's Full Address: _____
Lessor's Full Telephone/Mobile No.: _____
Lessor's Email Address: _____
Monthly Rental: _____

3. BUSINESS ACTIVITY

Line of Business	No. of Units	Capitalization (for New Business)	Gross/ Sales Receipts (for Renewal)	
			Essential	Non-Essential
Bags and Luggage	54	25,000		

I DECLARE UNDER PENALTY OF PERJURY that the foregoing information are true based on my personal knowledge and authentic records. Further, I agree to comply with the regulatory requirement and other deficiencies within 30 days from release of the business permit.

Angelina Isabelle S. Tejada
 SIGNATURE OF APPLICANT/TAXPAYER OVER PRINTED NAME

Figure 2. Mayors Permit Form

Figure 3. BIR Form

Kargaen's goal was to supply products that were of everyday use. The business has produced quality bags made by skilled seamstresses in hopes of providing additional livelihood and promote the skills of the locals in the community. The business also aimed to spread awareness of the concepts of sustainability and environmental consumerism as well as the production and promotion of items with eco-friendly natures—while still being commercially competitive to meet the owners' expectations on the return on investments.

Kargaen aimed to be known in the area of Biñan, Laguna in delivering quality tote bags. The business hoped to be included in the consumers' choice when selecting bags or luggage. All products that were available for sale by Kargaen were eco-friendly, impacting the lifestyle of environmentally conscious users. The business team of Kargaen is composed of Grade 12 students aspiring to be successful entrepreneurs. The power team of five students chose the sale of tote bags as a basic and versatile introductory product of the business. The roles of the members in the organization were assigned according to their potentials, talents, and contributions to the startup business and were responsible to managing specific business organizational roles, namely, operations and production, human resource, finance, and marketing, to meet the business's objectives (Bloomenthal, 2021).

The Owner and General Manager is at the top of the organizational chart and responsible for the organization's members' synergy and cooperation. The roles of Assistant Manager and Operations and Production Manager of the business are assigned to Angelina Tejada, with the task to oversee the team of managers' collective performance in the General Manager's absence. As Operations and Production Manager, Ms. Tejada was tasked to monitor the effective and efficient procedures each department is assigned to in order to produce and trade the business's product. The Finance Manager of the business is Raphael Buquiz. Based on the organizational business chart, the following managerial roles were outlined: the Finance Manager of the business is Raphael Buquiz. As Finance Manager, Mr. Buquiz was responsible for the overall financial standing of the business. The Human Resource Manager of the business is Paul Diaz. As Human Resource Manager, Mr. Diaz was tasked to help the business in outsourcing the needed manpower and services. The Marketing Manager of the business is Edilberto Tamis. Mr. Tamis was responsible for promoting, updating, and keeping track of the business's social media presence on sites such a



Facebook and Instagram to give the company the strong advantage that social media brings to the business, especially given the situation of community quarantine.

II. BUSINESS PLAN IMPLEMENTATION

II.A. Production

The production process started with the search of materials needed for the tote bags. The goal was to purchase quality materials within a reasonable price range. After retrieving all of the necessary items needed to fulfill the production process of the tote bags, it was later given to the seamstress for manufacturing.

One of the business members had proposed to use a Philippine fabric that could possibly display the talents and craftsmanship of the indigenous people—specifically from the Ilocos region. Inabel fabric is known for its unique stunning designs and durability (Kathleen Dinah Trocino, 2019). Additionally, the business members decided to purchase the fabric from its origin, which is Ilocos. The business would ideally like to be recognized as a business that sells authentic products. The following materials needed for the overall production are: canvas fabric, inabel fabric, oval hooks, buckle rings, webbing fabric, boxes, kraft paper, thank you stickers, thank you cards, and logo stickers resulting in a price of Php. 23,000.24. The production cost of each tote bag amounts to about Php150.00.

After the first set of products was manufactured, it was then gathered, quality-checked, sanitized, and packaged accordingly. The sanitation process was also done as an initiative by the business members to ensure the safety of every customer receiving the product. After packaging, a quota-based style of selling was adopted by the managers to distribute the needed amount equally to every business member.

II.B. Marketing

Pricing

Kargaen decided to sell the errand-sized bags and laptop-sized bags for six hundred (600) pesos and six hundred fifty (650) pesos. Initially, the markup that Kargaen decided to go with was thirty percent (30%). Since Kargaen is an emerging business, we want the price of our products to be competitive, and we have to settle for lower profit at this point in our business.

Table 1. Pricing Of Product Variations

Product	Price
Blue Inabel Variation (Errand Size)	PHP 600.00
Grey Inabel Variation (Errand Size)	PHP 600.00
Blue Inabel Variation (Laptop Size)	PHP 650.00
Grey Inabel Variation (Laptop Size)	PHP 650.00

Product

Kargaen opted for the sale of tote bags. Our tote bag is not the same as others since it is unique. One side of the bag has our featured fabric inabel and the other side being a minimalist and customizable plain canvas. Additionally, there are four available pockets present on the minimalist side of the tote bag. Kargaen tote bags encourage the creativity of customers whenever they express their artistry on the minimalists' side of the tote bag.

Figure 4. Product Pictures

Blue Inabel Variation (Errand Size)	Grey Inabel Variation (Errand Size)
	
Blue Inabel Variation (Laptop Size)	Grey Inabel Variation (Laptop Size)
	

Place

Kargaen's main address is at Southpoint Subdivision Blk80 Lot39 Pulo, Cabuyao, Laguna; the members have strategized on scheduling a date the members could pick up their orders. Before the products are dispersed, the Operations and Production Manager does a quality check and later given to the other business members for selling.

Figure 5. "SouthPoint Subdivision"



Promotion

Promotions for Kargaen were centralized on their featured fabric inabel, which came directly from Ilocos (Alalwan et al., 2017). Kargaen promoted through social media platforms that are customer-friendly such as Instagram and Facebook. An example of one of our promotions is teaching the targeted audience a set of phrases in Ilocano. Kargaen solely thought about how the audience may feel in any way connected with the Philippine culture.

Figure 6. *Publication Material*



II.C. Human Resources

Besides our current personnel of five managers, the business hired one subcontractor.

The business wanted to make payments easier; therefore, only paying for one personnel. Initially, the business also wanted to potentially lessen any money loss when the business decides to hire more workers.

The business made arrangements with a subcontractor through Ms. Tejada. The subcontractor is a seamstress with years of experience; therefore, we were able to trust our subcontractor that our products are of good quality.

The business plans to expand the plantilla by hiring couriers to deliver products to our customers. Before, the managers delivered the bags themselves; nowadays, they are trying to integrate this for efficiency and safety of the personnel and customers.

For our compensation, because the business plans to liquidate, the annual salary will not be calculated; however, this would be the cut of all members.

Table 2. *Compensation Packages of the Managers after Liquidation*

General Manager	P5026
Operations and Assistant Manager	P5026
Financial Manager	P5026
Marketing Manager	P5026
Human Resources Manager	P5026

II.D. Finance

At the end of January 2021, the business's earnings totaled fourteen thousand nine hundred (14,900) pesos, while our ending inventory resulted in two thousand six hundred ninety-five (2,695) pesos. The business was at a net loss of five thousand four hundred five (5,405) pesos due to the difference of the sales (14,900) and the cost of goods sold which amounted to twenty thousand three hundred five (20,305) pesos. Initially, the business had to pay the seamstress one hundred fifty (150) pesos per bag which added to the total expenses. Although the pandemic is a reason as to why there have not been as much sales as expected, we understand that people would rather focus their finances on basic necessities such as food, water, and sanitary supplies. On the other hand, the business is doing well because we have sold enough to reach fifty percent (50%) right after starting the business operations. The financial manager projected that the business would have an income of fourteen thousand three hundred fifty (14,350) pesos by the end of March 2021.



Figure 7. Income Statement

KARGAEN INCOME STATEMENT For the quarter ending October - January 2021				
Sales				
Errand	(14 x 600)		8,400.00	
Laptop	(10 x 650)		6,500.00	
Total Sales				P 14,900.00
Less: Cost of Goods Sold				
Purchases		23,000.24		
Less: Ending Inventory				
Errand	(3 x 315)	945.00		
Laptop	(5 x 350)	1,750.00	2,695.00	
Total Cost of Goods Sold			20,305.24	
Net Sales			(5,405.24)	
Less: Operating Expenses				
Salaries and wages		5,250.00		
Total Expenses			5,250.00	
Net Income (Net Loss)				P -10,655

Figure 10. Projected Balance Sheet

KARGAEN PROJECTED BALANCE SHEET As of March 31, 2021			
Assets			
Cash on hand			P 39,350.00
Total Assets			P 39,350.00
Liabilities & Owner's Equity			
Liabilities			
Total Liabilities			0
Owner's Equity			
Tejada, Capital		P 25,000.00	
Add: Net Income		14,350.00	
Total Owner's Equity		P 39,350.00	
Total Liabilities & Owner's Equity			39,350.00

Figure 8. Projected Income Statement

KARGAEN PROJECTED INCOME STATEMENT For the month ending March 2021				
Sales				
Errand	(13 x 600)		7,800.00	
Laptop	(17 x 650)		11,050.00	
Total Sales				P 18,850.00
Less: Operating Expenses				
Salaries and wages		4,500.00		
Total Expenses			4,500.00	
Net Income (Net Loss)				P 14,350.00

Figure 9. Balance Sheet

KARGAEN BALANCE SHEET As of January 31, 2021			
Assets			
Cash on hand		P 5,030.00	
Cash in Gcash		3,450.00	
Cash in Bank		6,250.00	
Accounts Receivable - Tejada		170.00	
Merchandise Inventory		2,695.00	
Total Assets		P 17,595.00	
Liabilities & Owner's Equity			
Liabilities			
Accounts Payable - Tejada		P 2,250.00	
Accounts Payable - Diaz		1,000.00	
Total Liabilities		3,250.00	
Owner's Equity			
Tejada, Capital		P 25,000.00	
Less: Net Loss		-10,655.00	
Total Owner's Equity		P 14,345.00	
Total Liabilities & Owner's Equity			17,595.00

III. PRODUCT DIVERSIFICATION

The next product to be featured is fresher, culture-centered, and greatly takes part in the environmental movement by taking another step into making each product eco-friendly and multipurpose as much as possible. This includes the packaging for every product manufactured.

Kargaen aimed for a simpler design for their next product. The bag will bear three pockets inside; one pocket will be placed at the right of the bag, and the other pocket will be on the opposite side. Following, the last pocket will be placed at the top center part of the bag. Furthermore, the bag will contain a front pocket with special embroidered detailing containing the business name in *baybayin* as this is another way of showcasing our Philippine culture. The material used for the bag would be canvas, which is generally known for its eco-friendly characteristics. Additionally, the business solely aims to make *baybayin* prevalent in the Philippines as there are not many individuals who are aware—let alone know how to write *baybayin*.

The product would simply be wrapped in kraft paper, ideally known to be eco-friendly as well. It would be sealed with a thank you sticker and twine. Additionally, it also contains a thank you card as a sign of gratitude to the customers who have purchased the business' product.

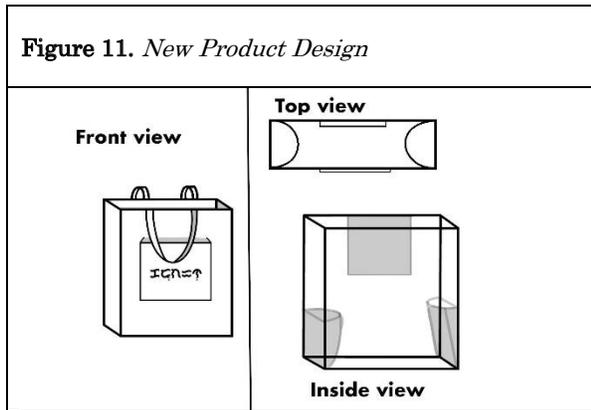

IV. FUTURE PLANS

The business plans on initially selling the original designs of the tote bags; however, other business members have started to brainstorm on new design ideas that are sure to be in trend.

In addition, the business would also like to give back to the community; therefore, they plan on giving a percentage of their earned profits to the indigenous communities of the Ilocos. The business plans to give 10% of their shared profit for now, but in later occurrences, they may increase the amount. The platform the business plans on donating the money to would be through online means since there are many different charities to select from, like the International Alert and the Cartwheel Foundation.

The "Kargaen" name will also be trademarked by the business such that it cannot be used by anyone except the business and everyone involved within the business; however, because the reversible feature of our tote bags is patented, the business would have to negotiate with the owner of the patent wherein we pay an amount that benefits both sides.

Furthermore, the business also plans to turn into a partnership type of business since it is much more suitable for the business respectively. Additionally, the business strives to register as a partnership since there are unlimited liability risks in a sole proprietorship type of business. Moreover, the business would also register the designs to be protected by a patent—this also includes the product name. Lastly, the business could also consider expanding and selling on online selling platforms such as Lazada or Shopee. This could be a key opportunity for the business to improve and entice future investors.

V. ACKNOWLEDGMENT

Firstly, the business team would like to sincerely thank our Lord God almighty for continuously showering the team with blessings throughout the business simulation and the research paper process. Thanks to his constant guidance, the group can constantly deliver and achieve what they need to succeed.

The group would also like to give their sincere gratitude and thanks to the people who are involved in constructing the research paper. These people whom the group would like to thank are our research adviser, Sir Generie M. Manuel, our former practical research teacher Ms. Maya Magsino, and lastly the De La Salle University for bestowing upon us students an excellent opportunity to take part in this research endeavor.

Our research adviser, Sir Generie M. Manuel, constantly guided the group in the right direction. He kept the team on the proper path all throughout the journey, which positively impacted the team by finishing their tasks and improving their work. His inputs were able to help the group to make their performance better. Ms. Maya Magsino was able to help the group by giving insights on our proposed products before directing them to our research adviser. She helped the group reevaluate and gain some confidence. Lastly, the group would like to thank De La Salle University for giving the team an opportunity to experience an actual business simulation.

Furthermore, the group would also like to give thanks and our sincere gratitude to our loved ones for constantly giving us support throughout this experience. Every member wishes to express their appreciation for their countless prayers for us in relation to completing a fruitful research paper. The group members would also like to express our sincerest gratitude to our family and relatives for supporting us with our initial capital investment, which aided us in developing our business product, as the group appreciates the sacrifices they had made to make this business and research paper come into reality.

VI. REFERENCES/APPENDICES

- Alalwan, A. A., Rana, N. P., Dwivedi, Y. K., & Algharabat, R. (2017, May 25). Social media in marketing: A review and analysis of the existing literature. *Telematics and Informatics*. <https://www.sciencedirect.com/science/article/abs/pii/S0736585317301077>.
- Banton, C. (2020, December 27). General Manager (GM). *Investopedia*. <https://www.investopedia.com/terms/g/general-manager.asp>



3RD DLSU SENIOR HIGH SCHOOL RESEARCH CONGRESS

Baquillas, J. C. (2018, March 3). Buying local or foreign brands: Does consumer ethnocentrism affect purchase intention? *ResearchGate*. https://www.researchgate.net/publication/326689162_Buying_Local_or_Foreign_Brands_Does_Consumer_Ethnocentrism_Affect_Purchase_Intention

Belarmino, T. et. al. (2021). FinalPaper.Entrepreneurship. *Google Docs*. https://docs.google.com/document/d/1FYx5ruDFRdA3T2cv-v8DTNpOSNI0Qh0ck5gXU_KqKeE/edit

Belarmino, T. et. al. (2021). FinalPaper.Practical Research. *Google Docs*. <https://docs.google.com/document/d/1B7YqY0OGjCP5Fatqzq3wjVDWTUfu1I21HJhp7qAJyM/edit>

Bloomenthal, A. (2021, February 22). The Power of the Organizational Chart. (2021). *Investopedia*. <https://www.investopedia.com/terms/o/organizational-chart.asp#:~:text=An%20organizational%20chart%20is%20a,between%20individuals%20within%20an%20entity.>

Calaby, L. (2018, November 19). Marketing manager job description | Totaljobs. *Totaljobs*. [https://www.totaljobs.com/advice/marketing-manager-job-description#:~:text=A%20marketing%20manager%20is%20responsible,the%20creation%20of%20marketing%](https://www.totaljobs.com/advice/marketing-manager-job-description#:~:text=A%20marketing%20manager%20is%20responsible,the%20creation%20of%20marketing%20)

Campbell, P. (n.d.). What is economy pricing? Definition, examples, and expert opinions. <https://www.profitwell.com/recur/all/economy-pricing>.

Fay, R. (1998 August). What form of ownership is best? - *ProQuest*. (2021). Proquest.com. <https://search.proquest.com/openview/52f6c98fd02871d3b451cbc9c89dc9d1/1?pq-origsite=gscholar&cbl=4179>

Kathleen Dinah Trocino. (2019, October 29). The Inabel of Ilocos: Woven Cloth for Everyday. NARRA STUDIO; NARRA STUDIO. <https://narrastudio.com/blogs/journal/the-inabel-of-ilocos-woven-cloth-for-everyday>

Kenton, W. (2020, July 28). Human Resources (HR). *Investopedia*. <https://www.investopedia.com/terms/h/humanresources.asp>

McClay, R. (2019, September 25). Operations Management Theory. *Investopedia*. <https://www.investopedia.com/ask/answers/050715/what-operations-management-theory-and-how-can-it-help-business.asp>

Sharma, A., Iyer, G. R., Mehrotra, A., & Krishnan, R. (2009, January 6). Sustainability and business-to-business marketing: A framework and

implications. *Industrial Marketing Management*. <https://www.sciencedirect.com/science/article/abs/pii/S0019850108001600>.

United Nations. (n.d.). *Goal 12 | Department of Economic and Social Affairs*. United Nations. <https://sdgs.un.org/goals/goal12>.

Wasiq, M., & Bashar, A. (2012, December). (PDF) Effectiveness of social media as a marketing tool: An empirical study. *ResearchGate*. https://www.researchgate.net/publication/281676030_EFFECTIVENESS_OF_SOCIAL_MEDIA_AS_A_MARKETING_TOOL_AN_EMPIRICAL_STUDY

Minutes of the meeting

MINUTES OF THE MEETING
(MARCH 15-19)
Business Enterprise Simulation
(Kargaen)

Meeting Information:

Location	[google meeting] (each respective individual was located in their respective homes)
Date	March 19, 2021 (FRIDAY)
Time	(10:00-10:30)

Attendance:

Name	Signature
Trishia Emilia L. Belarmino	
Raphael Angelo Buquitz	
Paul Alfred U. Diaz	
Edilberto II L. Tamis	
Angelina Isabelle S. Tejada	

Presiding Officer:

Name	Signature
Sir. Generie Manuel	(N/A)

Attendees:

Name	Signature



3RD DLSU SENIOR HIGH SCHOOL RESEARCH CONGRESS

2020-2021

BUSINESS CONCEPT BAZAAR

Trishia Emilia L. Belardino	
Raphael Angelo Buquiz	
Edilberto II L. Tamis	
Angelina Isabelle S. Tejada	

Absentee/s:

Name	Reason
Paul Alfred U. Diaz	(N/A)

Agenda:

Information	Additional Notes

Update Sir. Gene about the recent sales and products. In addition, make a schedule or timetable in completing the research congress paper.	"SCHEDULE" Friday (March 19, 2021): Finish Individual Tasks Saturday (March 20, 2021): Trishia Checks Paper Sunday (March 21, 2021): Final Checking By Each Member Monday (March 22, 2021): Submit To Sir. Gene
--	---

Action Items:

Information	Additional Notes
[Item description, point person, due date] (N/A)	(N/A)

Other Notes:

Information	Additional Notes
Trishia's Mom Will Pick Up Tote Bags From Geli's Subdivision (5 ORDERS)	"ORDERS" - LAPTOP SIZE - BLUE (650) - LAPTOP SIZE - BLUE (650) - LAPTOP SIZE - BLUE (650) - LAPTOP SIZE - GREY (650) - ERRAND SIZE - BLUE (600)

Screenshot/s Of The Meeting:

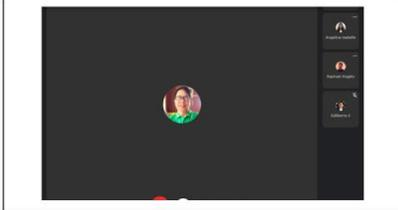
Image/s

Prepared by:
Trishia Emilia L. Belardino
General Manager and Owner, Kargaon

Noted by:
Sir. Generie Manuel



UNFURL OFFICIAL



Sher Ashley P. Aquino, Van Ace D. Baña, Gian Kenneth G. Celino, Aezra Reign A. Dionisio,
 and Charles Patrick A. McMillan
 De La Salle University Integrated School, Biñan City, Laguna

Executive Summary: Hoodies can be found anywhere because they can be used for comfort and fashion. However, if customers want a different level of comfort and security when they wear their hoodies, Unfurl may be just what they are looking for. Unfurl was established in the year 2020 and is located in Laguna. Unfurl focuses on giving customers high-quality premium products and integrating fashion and comfort into their apparel. Their Marketing and Sales is focused on online selling, utilizing social media platforms to sell their products. Unfurl is a socially aware clothing brand that spreads awareness and advocates change on ongoing global issues like climate change, pollution, and many more through their designs, packaging, and social media. They also aim to solve a common problem with securing valuables through their innovative secret pocket design. The sales projection for 2021 is Php 130,000.00. Each member has invested Php 4,000 with a total of Php 20,000 for their capital which was enough to secure their first batch profit of more than Php 4,000 and exceed their break-even. In the future and with the help of effective marketing, Unfurl is planning to expand their line in apparel and include shirts into their brand.

Key Words: Hoodies; Innovative; advocates; comfort; clothing-brand

Mission

“Guided by the values of teamwork, respect, and integrity, Unfurl is dedicated to incorporating fashion and comfort through apparel that will be able to secure the valuables of our customers nationwide while also raising awareness on global issues. We firmly believe that anyone is capable of advocating change that will help in making the world a better place for everyone.”

Vision

“Unfurl is a socially aware brand, and through little or big gestures, Unfurl aspires to fulfill the desire of a person to help and be a vessel of change. Anyone who wears Unfurl’s apparel will feel empowered and feel the highest level of comfort and security. We aim to bring a positive impact to the community and build a positive relationship with our stakeholders.”

I. BUSINESS REGISTRATION AND ORGANIZATION

Figure 1.1. DTI Registration First Page

Republic of the Philippines
 Department of Trade and Industry
BUSINESS NAME REGISTRATION
 SOLE PROPRIETORSHIP APPLICATION FORM

PLEASE READ THE GENERAL RESTRICTIONS ON THE LAST PAGE BEFORE FILING UP THIS APPLICATION FORM

A. TYPE OF DTI REGISTRATION

1. NEW
 RENEWAL. Contribution Fee: _____ Application Deadline: **30 December 2020**

B. TAX REGISTRATION NO. (TRN)

2. WITH TRN. Current TRN: _____ Without TRN

C. OWNER'S INFORMATION

3. First Name: AERNA REGIN 4. Middle Name: ANGE 5. Last Name: DIONISIO 6. Birth Date (dd-mm-yyyy): _____

7. Date of Birth: Year: 2003, Month: April, Day: 08 8. Civil Status: Single Legally Separated Married Widowed 9. Gender: Male Female 10. Any type of Disability? Yes No

11. Citizenship: Foreign PHILIPPINES FILIPINO

D. BUSINESS NAME REGISTRATION - Please check ONLY 1 item

12. Payment of P 500.00 Contribution fee of 400.00 Regular P 1,000.00 Reduced P 500.00 Payment of P 20.00 Documentary Stamp Tax to be submitted Scanned for electronic submission (only for registration fee of P 500.00 and P 1,000.00 only after approval)

E. PROPOSED BUSINESS NAME - Please provide at least three (3) proposed Business Name options

13. UNFURL APPAREL STORE

14. _____

15. _____

F. BUSINESS DETAILS

16. Business Name: UNFURL APPAREL STORE 17. Street: BEAN STREET

18. Business Address: 19. City/Municipality: CALABANG 20. Province: LAGUNA

21. Region: REGION IV-A (CALABARZON) 22. Phone No. (0+area code): _____ 23. ALIAS No.: 999999999



3RD DLSU SENIOR HIGH SCHOOL RESEARCH CONGRESS

Figure 1.2. DTI Registration Second Page

G. PHILIPPINE STANDARD INDUSTRIAL CLASSIFICATION (PSIC)			
24. Main Business <input type="checkbox"/> Manufacturer/Producer <input type="checkbox"/> Wholesaler		25. PSIC (Indicate Main Product Handled/Service Rendered) RETAIL SALE OF CLOTHING, FOOTWEAR AND LEATHER ARTICLES IN SPECIALIZED STORES	
<input type="checkbox"/> Service <input type="checkbox"/> Importer		<input type="checkbox"/> Retailer <input type="checkbox"/> Exporter	
H. OWNER DETAILS			
<input type="checkbox"/> Same as Business Details provided in box Nos. 16 to 23. Proceed to no. 34			
26. House/Building No. & Name: BLK 20 LOT 5		27. Street BEAR STREET	
29. City/Municipality CITY OF CALAMBA		30. Province LAGUNA	
32. Phone No. (Area Code)		33. Mobile No. 09663552090	
		34. Email Address AEZRA_REIGN_DIONISIO@DLSU.EDU.PH	
I. PARTNER AGENCIES			
35. Core agencies registration (Please choose what ERNs you want to have): <input type="checkbox"/> PhilHealth <input type="checkbox"/> SSS <input type="checkbox"/> Pag-IBIG			
H. OTHER DETAILS			
36. Asset 0.00		37. Capitalization 0.00	
39. Planned No. of Employees Male: 0		Female: 0 Total: 0	

FOR DTI USE ONLY			
Approved Business Name	Fee	Received by	
-	2,030.00		
Business Name No.	Date Registered	OR Number	Date Paid
-	-	-	-
Issuing Office	Processed by	Reference Code YV21455011726212	
-	-		
BIR Tax Identification No	SSS Employer No	PhilHealth Employer No	Pag-IBIG Employer No
-	-	-	-

The team was able to finish the DTI Registration form by filling out the information needed. Through their website, they were able to download the filled out form that includes the proposed business name and other details about the owner and the business.

Figure 2.1. BIR Registration First Page

Figure 2.2. BIR Registration Second Page

Provided with the personal information that is given by Unful's owner, the BIR application for registration is filled out. Other personal information like the address from another manager was also utilized to comply with the necessary information that was asked. In completing the application for registration, the BIR Form No. 1901 was taken directly from BIR's website to make sure that the form was up to date.

Figure 3.1. Mayor's Permit First Page

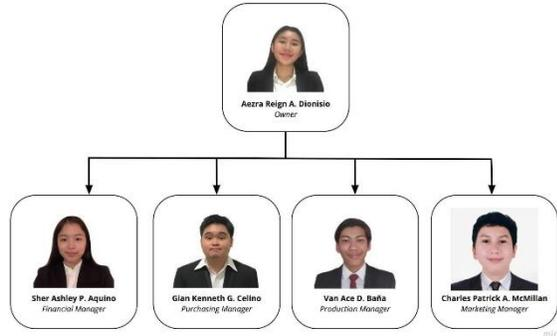

Figure 3.2. Mayor's Permit Page 2

CITY VETERINARIAN OFFICE For Mayor's Permit			
Business Permit & License Office			
Mayor's Permit received By:		Business Plate No.:	
Signature _____	Date _____	Signature _____	Date _____
Name in Print _____		Name in Print _____	
Business Trade Name: Unfurl Official		BUSINESS PERMIT AND PLATE CLAIM STUB	
Date of Release: _____		Mayor's Permit No.: _____	
Time Release: _____		Released By: _____	
Pasay City Official website: www.pasay.gov.ph			

Using a real-life simulation, Unfurl was able to apply for the business's mayor's permit using the owner's details in order for the applied documents to have a continuous and clean output of details.

Figure 4. Organizational Chart



Unfurl is a sole proprietorship and is composed of five key personnel who manage the business; the Owner, the Finance Manager, the Marketing Manager, the Operations Manager, and the Purchasing Manager. Each member of the business will receive the same rights and benefits; thus the responsibilities within the venture are equal, and the distribution of payments at the end of the period will be made equal to each of the members of the business.

II. BUSINESS PLAN IMPLEMENTATION

II.A. Production

Unfurl's production begins with the help of a graphic designer. The team utilized the help of the designer to improve their designs but at the same time, to support small artists. For the product itself, Unfurl gets their hoodies from Gravitee Sales Corporation, a local distributor of Gildan products. As for the embroidery and printing of the designs, these services are both located at Biñan, Laguna. For Unfurl's packaging, the team uses online shopping websites such as Shopee and Lazada.

II.B. Marketing

Unfurl makes use of the 4p's of Marketing. First, the essential part of the business, Unfurl offers oversized high-quality premium hoodies made of cotton and polyester. It also adds security with its unique secret pocket feature. The design is simple and trendy; the front portion has Unfurl's logo embroidered while the back part has a printed design with a cyber-retro with funky design inspired by current global issues with the intention to spread awareness and advocate change. Frosted string bags are the packaging of Unfurl products. It was chosen for its elegant appearance and its functionality since it is reusable.



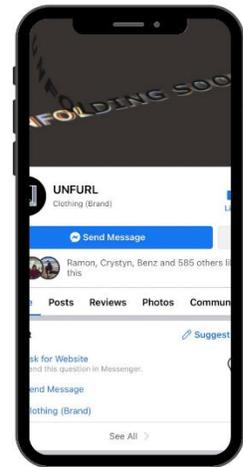
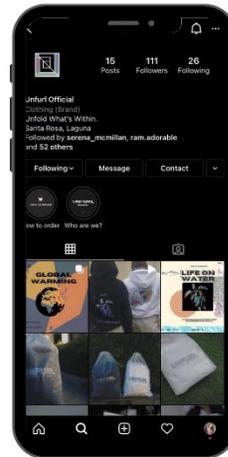

II.C. Human Resources

The Unfurl team consists of five members with their specific roles in the business. The owner, financial manager, purchasing manager, production manager, and marketing manager. Aezra Dionisio, Unfurl's Owner, is in charge of managing all activities happening within the business. She makes sure that all the departments help each other in operating the business. She also oversees the possible problems the company could face and how to solve them. The Financial Manager, Ashley Aquino, keeps track of Unfurl's expenses and sales. She is in charge of safe-keeping Unfurl's money while being transparent to all the members by sharing a Google sheet that has all the financial statements needed in making decisions. Gian Celino, the Purchasing Manager, is in charge of purchasing the materials required in producing Unfurl hoodies. The production consults the purchasing manager before buying materials. Ace Baña, the Production Manager, is in charge of contacting suppliers and service providers. He makes sure that the service providers will be able to embroider, print, and alter the products correctly and efficiently while minimizing costs. Charles McMillan, the Marketing Manager, is responsible for social media postings and contacting possible models and ambassadors. He is in charge of promoting our products to our target market and the public.

Second, Unfurl hoodies' current price point is 999 pesos. One of Unfurl's marketing strategies is through its pricing; the price may depend on the cost, but Unfurl makes it affordable for its premium high-quality material compared to its competitors to entice the customers.

Third, unfurl uses a direct distribution channel. They control all of the operations, decisions, and prices to sell their products. This also helps build a better relationship with their customers.

Lastly, their Marketing and sales focus on online selling, utilizing social media platforms such as Facebook and Instagram to sell their products. Since the pandemic, most people have turned to online shopping as an alternative and for convenience and safety reasons as well.



II.D. Finance

Figure 5.1. Income Statement

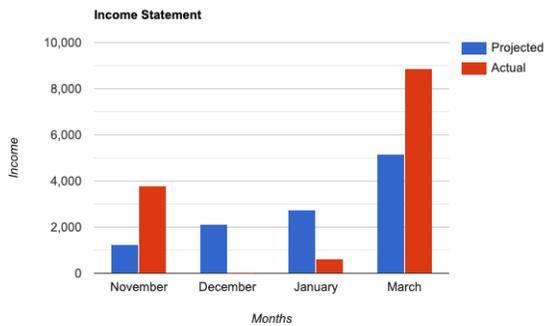

As shown in the graph above, March has the highest actual income. During the start of Unfurl's operations, Unfurl hoodies were sold for the price of only P945 pesos that was the team's strategy to penetrate the market. The strategy used helped Unfurl to be able to sell out their hoodies during the first month of selling. However, the profit was not maximized during the first release. The team then decided to increase the price by P54 pesos leading to a price of P999 per hoodie. The minimal increase in price contributed to having higher income for the month of March.

Table 1.1. November Income Statement

UNFURL Income Statement For the Month Ended November 30, 2020				
			Projected	Actual
Net Sales Revenue		P	11,340	22,680
Cost of Sales			9,200	18,400
Gross profit			2,140	4,680
Total Income		P	2,140	4,680
Operating Expenses				
Distribution expense	P	883.00	-883	-883
Net income			1,257	3,797

Table 1.2. December Income Statement

UNFURL Income Statement For the Month Ended December 31, 2020				
			Projected	Actual
Net Sales Revenue		P	11,340	0
Cost of Sales			9,200	0
Gross profit			2,140	0
Total Income		P	2,140	0
Operating Expenses				
Distribution expense	P	-		
Net income			2,140	0

Table 1.3. January Income Statement

UNFURL Income Statement For the Month Ended January 31, 2021				
			Projected	Actual
Net Sales Revenue		P	9,990	2,997
Cost of Sales			7,000	2,100
Gross profit			2,990	897
Total Income		P	2,990	897
Operating Expenses				
Distribution expense	P	-255.00		
Net income			2,735	642

Table 1.4. March Income Statement

UNFURL Income Statement For the Month Ended March 31, 2021				
			Projected	Actual
Net Sales Revenue		P	26,460	27,972
Cost of Sales			21,196	19,096
Gross profit			5,264	8,676
Net income			5,264	8,676

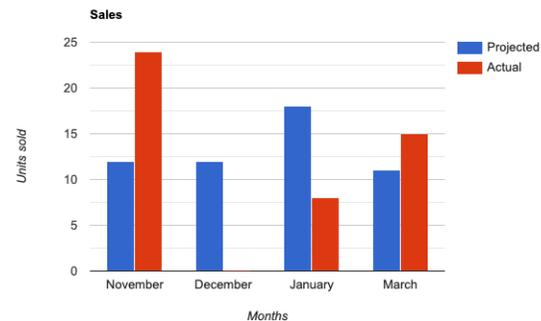

Figure 5.2. Units sold

In Figure 5.2, we can see that there were no sales during December. This is because the team was able to sell out the first batch during the first month of selling. For the second batch of hoodies, the team was not able to reach the sales quota for the month of January. However, the team was able to sell more than what was projected for the month of March.

III. PRODUCT DIVERSIFICATION

For the diversification product, Unfurl has decided to push through with shirts, specifically oversized round neck shirts. Unfurl would like to offer shirts that are affordable, stylish, and high in quality. The shirts would also have graphic designs about global issues as it is part of Unfurl's purpose from the very beginning. We ought to maintain the designs while opting for a minimal vibe for the features of the shirt. We also chose shirts for the reason that it is a piece of clothing that everyone can wear—perfect for going out casually, for fashion, and even as stay-at-home loungewear, giving customers not only their desired stylish and fashionable demands, but also the highest level of comfort when they wear these shirts. Made from high-quality cotton material, we will mainly be focusing on the oversized aspect or “oversized shirts” since it is trendy and chic. Furthermore, sizes ranging from small up to extra-large and two different colors from Unfurl's color palette for the shirts are what we can all expect to be executed for the release.



IV. FUTURE PLANS

Unfurl plans to widen its range of products and will venture into future trends in the apparel industry. Unfurl aims to extend the target market by joining bazaars to showcase the products that Unfurl offers. Unfurl will also try to broaden what they can showcase to their customers by adding more stylish garments with different designs, which will allow customers to select from various styles. Furthermore, with Unfurl's mission to spread awareness on global issues, the team aims to better incorporate it into their ventures, not just through their designs but by involving the business with non-profit organizations. With that, Unfurl is in talks with an organization called Bahay Pag-Asa Youth Rehabilitation in hopes to be a vessel of hope to them; Unfurl plans to shoulder a week's load of groceries and be of help in any way we can. When the time is right, Unfurl Official aims to proceed with taking legal and appropriate actions into claiming rights to our products in the eyes of the law. Unfurl will be able to take full ownership and sole rights to every product that we have published using tools such as patents, copyrights, and licenses used in the publication of our products. In the future, where we will begin to work with other entrepreneurs alike, Unfurl official plans to make use of royalties that will become useful when the given occasion arises. In the future, when the pandemic is over, and it is safe for everyone, Unfurl is hopeful for physical stands, joining bazaars, and meeting with people to further expand their audiences.

V. ACKNOWLEDGEMENT

Unfurl's venture and the research paper would not have been possible without the support from everyone. The member's parents/guardians for keeping us safe and secured, our friends, teachers, relatives, and in essence, all those around us. Unfurl would like to express their gratitude towards those who have been an instrument in making this possible, A2Z printing, Gravitee Sales Corporation, Emad embroidery, Chia Basan, even the couriers involved in the process. Immeasurable gratitude goes to ABM's Practical Research teachers and advisers who have been there for the betterment of Unfurl. Thank you, **Ms. Windie Odone, Ms. Marife Magsino, and Ms. Nerisse Estrada**, for the knowledge, patience, support, guidance, and all of your efforts despite online classes you have helped us so much. Special thanks to Unfurl's research adviser, **Ms. Emmielyn Bardiano**, for keeping Unfurl on track, and for making sure Unfurl's outputs are the best they can be. We appreciate all the comments, love, support, and Unfurl is thankful to have you as their research adviser. Unfurl would also like to thank the institute of De La Salle University for the opportunity it's given us ABM students, and for the valuable knowledge and principles they've imparted to us.

VI. REFERENCES/APPENDICES

New building of Bahay Pag-asa ng Laguna inaugurated. (2019, August 6). Philippine Information Agency. <https://pia.gov.ph/news/articles/1025254>

Arthur, L. (2017, September 26). Direct sales force advantages. Bizfluent. <https://bizfluent.com/list-7416036-direct-sales-force-advantages.html>

Dunsby, M. (2019, February 25). The 7 pricing strategies every business owner has to know. Startups.co.uk. <https://startups.co.uk/planning/pricing-strategies-price-skimming>

ARTS PERFORMANCES AND EXHIBITIONS

The research papers under this category come with artworks and performances, which can be viewed through this link:
https://bit.ly/3rdDLSUSHSRC_APE



The Significant Impact: What Makes A Life Worth Living

Candid Dimples Garcia

St. Edward School, General Trias City, Cavite

Abstract: The literary pieces are written in free verse. Each piece tackles a different reality under the main theme of life after death. The works address interdependence and synergy and are inspired by Filipino life. The goal of the pieces is to spread awareness, change, and harmony. The author sought to illustrate the concept of living many lives and experiencing different forms of death (i.e., mentally, emotionally, & spiritually). The poems represent various voices of people and moments of truth.

Key Words: interdependence; propriety; life after death; voice; moment of truth

1. OVERVIEW OF THE ARTWORK

The literary pieces tackle the interdependence among people to see things beyond and make a change. It also talks about the right actions that could lead to a better way of living. The COVID-19 pandemic and the people who are affected by it inspired the making of these literary pieces. The aims of these works are (1) to open the eyes and hearts of people, (2) to speak up for those who cannot be heard, and (3) to make the world a better place.

2. UNDERSTANDING THE ARTWORK

Making the literary pieces started from brainstorming the desired topic, followed by free-writing ideas and choosing specific forms and styles. The next step of the process was reading other literary works for inspiration and more information. The writing began right after. Then, the literary pieces were checked word for word to see errors. A short break was taken for the refreshment of mind, and the last process was revision and finalization.

3. THE ARTWORK

There are five free-verse poems written in Filipino under the theme, *life after death*. Free verse has no limitations of meter and rhythm yet still artistically provides desirable shape and expressions. The literary works talk about different aspects of reality (i.e., interdependence and propriety of actions). The pieces are entitled “Orasan,” “Wakas,” “Piring,” “Pusang Sinagasaan,” and “Una at Huli.”

The poem entitled “Orasan” expresses the will to live despite all the hindrances. “Wakas” symbolizes an endpoint battle for safety and security. “Piring” talks about injustice and depth of feeling. The poem takes inspiration from the blindfolded Lady Justice, representing the justice system being blind to a person's wealth, gender, race, and power. The fourth poem entitled “Pusang Sinagasaan” symbolizes oppression and its impact. Last, “Una at Huli” talks

about the effects of influence and awareness. The theme, *life after death*, represents the reality of life and justice. It talks about how often people die within themselves and the truths behind it. People do not just live once, but they experience death many times, and in different ways (emotionally, mentally, & spiritually), which lead them to survive and begin again—live differently.

4. ACKNOWLEDGMENTS

The author would like to take this opportunity to acknowledge St. Edward School for allowing her to express her thoughts creatively and to share these works with others. She deeply expresses her gratitude for her support system—family, friends, and teachers—who constantly give the courage to make things out of love and bravery.

Lastly, the author thanks the Lord Almighty, who gives strength to live, speak, and influence her in daily living. This would not be accomplished without the help of Him.

5. REFERENCES

- Admin. “Free Verse - Definition and Examples of Free Verse.” *Literary Devices*, 2017, literarydevices.net/free-verse.
- Ki. “Malayang Taludturan Tula - Kahulugan At Halimbawa.” *Philippine News*, 8 May 2020, philnews.ph/2020/05/08/malayang-taludturan-tula-kahulugan-at-halimbawa.



Born This Way: A Short Story

Marie Antoinette Johanna M. Salamanca
De La Salle University Integrated School, Manila

Abstract: Philippine media, especially from the 2010s until the present, strives to make LGBTQ+ conversations ensue through easily consumable and accessible forms of art such as telenovelas and variety shows. Often, however, the industry forces queer individuals to stigmatize their own identity, very rarely taking the role of the protagonist, yet always the stereotypical sidekick-gossiper to the female lead. Lady Gaga's single "Born This Way" motivates Emman, who finds himself stuck in the middle of idolatry to the pop star and worship to God the Father. Engaging online series such as "Gaya sa Pelikula" and "Gameboys" also helped in shaping Emman and his boyfriend Alejandro's morales. The short story aspires to add to the collection of reliable and accurate representations of gay people in the Philippines combating the inner conflict of being true vs. being obedient to religion.

Key Words: LGBTQ+; Lady Gaga; Catholicism; discrimination; media

1. OVERVIEW OF THE ARTWORK

"Born This Way" alludes to Lady Gaga's breakout song and album that started her appeal towards LGBTQ+-identifying Filipinos. The first line of the song expresses, "it doesn't matter if you love him, or capital H-I-M," pertaining to loving a person of the same gender or loving God alone, which soon became the inspiration of the whole short story. The narrator plays with allusion and metaphors to mention that there are more commonalities between Christianity and admiration for a superstar than there are differences.

Emmanuel, the main character also flairs his vast knowledge of the two, comparing his experiences against discrimination to biblical figures such as Judas and to Lady Gaga's songs such as "Bad Romance" to describe the love he and his boyfriend loved, Alejandro, share.

Though rarely described, the physique and stature of the two boys are unlike the portrayal mainstream media constantly imposes. Alejandro is a tall and sporty boy, muscly and boastful, similar to how pop culture would describe a byproduct of macho culture. Emmanuel has a low voice, a bass cantor for his parish, very reserved and shy, contradicting the conventional loud, "tsismosang bakla sa kanto" trope.

2. UNDERSTANDING THE ARTWORK

The researcher constructed the character archetypes through thorough observation of documentaries and already available programs such as Juan Miguel Severo's (2020) "Gaya sa Pelikula," Nestor Abrogena's (2020) "Gameboys," and Weerachit Thongjila's (2020) "2Gether."

Thailand, despite being a progressive and widely accepting Southeast Asian nation, most

especially for gay and transgender people, 2Gether expresses the contrast between a forward-thinking country compared to another, hailed "most gay-friendly" in the continent.

Understanding Lady Gaga's discography and inspiration behind her hit song informed many decisions that complete the short story. Emmanuel, being the narrator, constantly alludes to his favorite artist, and an in-depth study of her musicality and artistic identity established his temperament.

3. THE ARTWORK

Emmanuel finds it difficult to choose sides. He loves his religion and God just as much as he does Lady Gaga, closely followed by his boyfriend, Alejandro. Emman mentions that the Church unjustly critiques the pop star's musical abilities judging solely based on the songs that allude to biblical events, very rarely those that expound topics and issues that religious leaders classify as taboos. He powers through heavy thoughts independently, never mentioning a single struggle about his life as a young gay man to Alejandro, the person he trusts most.

Ate Rosey is disgusted by the couple's audacity to publicly display affection, albeit knowing the homophobic nature of their barangay. This disturbs Emman greatly, waging war in himself once again, to either stop seeing Alejandro momentarily or to deal with the consequences of living his truth with the boy he loves when he comes home. As the more softhearted and overt in the relationship, Andro holds his boyfriend closer than ever, reassuring him of his protection and presence in the most dangerous situations; Emman finds this hard to believe because it comes from someone loved and respected by his family no matter the conditions.



When the attempts to hurt Emman fall into vain, they abuse Andro instead, stoning and punching him like they did martyrs and saints. Andro dismisses the negativity of the situation, knowing that Emmanuel will break the relationship off to ensure his safety. Emman concludes that he loves both God and Gaga equally, never to be changed, but if the cost of it is the life of his only confidant, he must love the former more than latter.

4. ACKNOWLEDGMENTS

Many thanks to Ms. Jaimee Esteban for helping me find avenues to share my works, specifically this one, and for her patience and understanding since this is my third submission to the Research Congress. I am very honored to learn from you.

My most profound gratitude to my queer friends, old and new, for trusting me with their stories, providing me with various perspectives to play with, and accepting Emman and Alejandro as their own. I hope to emulate and augment your reality in the most just and righteous way. Your energy and willingness to open these conversations, even in young adult short stories, are why I continue to make art. I will speak and listen to you until the day comes that you finally can.

I could not thank Stefani Germanotta enough for realizing the importance of her role as a person in pop culture and using her platform to speak for the silenced. Her songs and legacy are unrivaled and of most importance to the Filipino gay community. Born This Way is an anthem and title I will live by forever.

5. REFERENCES

- Neary, Lynn. "How 'Born This Way' Was Born: An LGBT Anthem's Pedigree." NPR, NPR, 30 Jan. 2019, www.npr.org/2019/01/30/687683804/lady-gaga-born-this-way-lgbt-american-anthem.
- Nitura, Jamina F. "Here's Why Everyone's Absolutely in Love With Thai Series '2gether.'" Preview, Preview Philippines, 20 Apr. 2020, www.preview.ph/culture/2gether-the-series-review-a00268-20200420.
- Tubeza, Philip C. "PH Ranks among Most Gay-Friendly in the World." INQUIRER.net, Philippine Daily Inquirer, 9 June 2013, globalnation.inquirer.net/76977/ph-ranks-among-most-gay-friendly-in-the-world.
- Zafar, Aylin. "Deconstructing Lady Gaga's 'Born This Way' Video." The Atlantic, Atlantic Media Company, 3 Mar. 2011, www.theatlantic.com/entertainment/archive/2011/03/deconstructing-lady-gagas-born-this-way-video/71924/.



Star For a Day: A One-act Play

Marie Antoinette Johanna M. Salamanca
De La Salle University Integrated School, Manila

Abstract: The play depicts a day in the life of a typical jeepney driver and his friend, passing the time at the terminal, hoping for more passengers and fewer chances of a phaseout. The men associate themselves with their vehicles, previously kings of the road being dethroned by modernity. “Star For a Day” is an ode to these drivers, the family depending on them, and the government officials who wish to eradicate them without remedy. The play wishes to address the spiking rates of unemployment, especially during the pandemic, and the sudden decrease of income, especially to barkers who depend on tips and freebies from the drivers they help. There is a more profound social commentary about the influence of the internet and amplifying the struggles of the working class and its lasting effects in pushing for change and allowing other demographics to combat poor leadership from the current administration.

Key Words: jeepney phaseout; working class; online advocacies; satire; trends

1. OVERVIEW OF THE ARTWORK

Created during the rise of the movement against jeepney phaseouts, *Star For a Day* is a satirical, light-hearted one-act play depicting the lives of the driver and barker Kuya Totoy and Mang Berto. The former entirely relies on the latter for help, sharing coins between them, hoping the number of centavos and one Peso coins suffice to buy the cheapest meal available. The ironic production attempts to open conversations only to be had online, like colonial mentality, discrimination against the poor, and the forceful implementation of up-to-date inventions by developed nations in third-world countries. If modernity were to happen, the drivers would have to pay for their cars. The money is immediately sent to already-rich corporations that earn more daily than the impoverished could in a lifetime.

Star For a Day is an in-the-moment, playful production, distracting the audience from the many points it proves, just as the main characters themselves find it punishing to accept their situations.

2. UNDERSTANDING THE ARTWORK

Depictions of the jeepney driver and the barker’s attitude were based on previous experiences and observations only. The plotline, however, revolves around the stories and opinions of real drivers who stand as the breadwinners of the family, as told during interviews and discussions with newscasters and researchers. On the other hand, satire and sarcasm are a symbolism to government officials and how they solve the issue of the lower class before and during the pandemic. Bradley stands as an allegory, Mang Berto and Kuya Totoy’s single chance of being heard through

his video logs and popularity to understand the role of the internet and mainstream media for social issues.

3. THE ARTWORK

Mang Berto and Kuya Totoy are best friends, partly because there is no one else to talk to and to share the same sentiments with at the terminal. Most of the hours at work are opportunities for siesta and rest, so much so that driving jeepneys and assisting those who steer them has started to become a pastime.

When the job starts to feel like a lost cause, Bradley, an internationally famous online influencer, visits their workplace to ask for help with directions. He finds the men’s personalities exciting and quirky enough to be included in his video, granting them a few seconds of pain, temporarily freeing them of their concerns. However, the two take advantage of this sudden stardom and start a fight, with Bradley recording them, answering back constantly, unaware that their new friend has already made use of their banter as content for the entire world to see. Mang Berto and Kuya Totoy’s relatives notice this and swiftly call to alert them of their carelessness. They realize the repercussions of acting rashly in front of someone with power. The Philippines laughs along with Bradley, and its people now understand why a jeepney phaseout, if its drivers refuse to take their situations seriously, is the correct thing to do, after all.

4. ACKNOWLEDGMENTS

My thanks to Ms. Jaimee Anne Esteban, who sees potential in my works and constantly pushes me to better myself after every creation. Because of your



help and trust in me, I directed and executed this play, deepening my love for the craft.

The completion of this play would not have been possible without my Contemporary Philippine Arts teacher, Mr. Ray Christian Cristobal. The countless times you read my works, critiqued them, and cheered me on will never be forgotten. Thank you for supporting me and voluntarily reading my works, even when I am sure no one does anymore.

To Diosem Budios, Lorenzo Buenafe, and Von Mendoza for bringing color to Star for A Day and being my actors. Working with you is a pleasure I do not take for granted. Your acting techniques transcend our time, and I hope to work with you again soon.

Finally, to the jeepney drivers who dropped me off at school and took me home afterward, you have always brought me to places I need to be safely. I wish and pray for the same to you, and it is with all my heart that I create this in hopes that you will once again be kings of the road.

5. REFERENCES

- Fernandez, Hannah Alcoseba. "Do Filipinos Dream of Electric Jeepneys?" *Eco, Eco-Business*, 28 Apr. 2020, www.eco-business.com/news/do-filipinos-dream-of-electric-jeepneys/.
- Lalu, Gabriel Pabico. "Don't Push Jeepney Phaseout during Pandemic, but Help Drivers Modernize – Robredo." *INQUIRER.net, Philippine Daily Inquirer*, 22 June 2020, newsinfo.inquirer.net/1295280/dont-push-jeepney-phaseout-this-pandemic-help-drivers-modernize-instead.
- Samantha Faye, and Eternity Ines. "Burning Rubber: A Day in the Life of a Jeepney Driver." *The LaSallian*, 27 May 2017, thelasallian.com/2017/05/27/burning-rubber-a-day-in-the-life-of-a-jeepney-driver/.



Tabi, tabi po: Filipino Mythologies and Superstitions as Motifs in a One-act Play Collection Surrounding Contemporary Society

Marie Antoinette Johanna M. Salamanca
De La Salle University Integrated School, Manila

Abstract: The paper studies the roles of Filipino mythologies and superstitions in the sociopolitical domain. During colonization, the Spaniards and Americans heavily condemned the widespread of fantastic and mythical religion, putting Western ideologies in place. The collection of plays attempts to retell these stories and discover the Filipino identity from the modern person's perspective living in a country where cultures are amalgamated. The most rampant sociopolitical issues in the Philippines include LGBTQIA+ and feminist struggles, "crab mentality" or smart shaming, and the OFW "brain drain," which are all depicted in the collection. For vivid imagery and better immersion, documentaries, forums, and memoirs showing real accounts of those who underwent discrimination for their specification were studied. However, the comedic exchanges and actions amongst the characters balance the weight that the mentioned topics carry. The conflicts are heightened more because of the difference in social classes, where the poor more typically have no escape against judgment and accusation. This study was created to make traditional literature more palatable to the masses who have less access.

Key Words: mythologies; superstitions; sociopolitical Philippines; intersectionality; postcolonialism

1. OVERVIEW OF THE ARTWORK

The collection of one-act plays depicts the parallelism of the present sociopolitical sphere to Filipino livelihood before and during the war. Both folktales and contemporary issues are signs of resistance and are suppressed by those in power (how the Spaniards and Americans eradicated mythological thinking vs. the poor solutions by the government to prevent gender discrimination and the disparity of the social classes). These commonalities help the audience or the reader to realize the importance of preserving national culture and ensuring its identity is retained.

The four one-act plays in the collection use superstition or mythology as the central motif of the story. Firstly, "Kutsilyo" discusses the superstition of the utensils, where if one falls, either a man or a woman arrives, a play under gender studies and non-binary identities. "Ang Promise ni Pango" follows, tackling brain drain and raising first-generation Filipino-Americans in the United States unaware of their motherland. In Mabel Cook Cole's collection entitled "Philippine Folk Tales," (1916) the Tagalog creation story "Malakas at Maganda" explains the couple's inability to care for their many children, some becoming immigrants to help themselves, returning to the island as white people, much like the characters.

The third play is entitled "Pagbati," which expounds on the saying "puwera usog," and how

detrimental it could be when Filipinos solely rely on the power of folk healers to protect their children from mythical monsters. It encourages action and change from the tradition of "Bathala na!" wherein one leaves their fate to the gods, come what may. The superstition is also said when the child's parents are known for their financial and social status, hoping the infant would be generous and fortunate enough when they grow older.

Lastly, "Buwayang Lubog" is inspired by "The Alligator's Fruit" from the Itneg people in Abra, northwestern Luzon. The folklore tells a story of two women eating picked fruits only for the animal to enjoy. When it learns about the stealers, the alligator threatens the townsmen, forcing them to find the women. It showcases a metaphor for the predatory motives of a misogynistic man, creeping behind innocent women vying for the forbidden fruit: equal rights.

All the plays included in the collection revolve around one universe and can be read in any order. However, the mentioned sequence is most recommended. Characters from a different play may appear in the current one, though their roles hold very little significance.

2. UNDERSTANDING THE ARTWORK

The researcher selected documentaries, forums, autobiographies, and movies to observe the



commonalities among them to merge the plays into a cohesive universe. From these related literature, anecdotes, and lived experiences of the queer community, first-generation Filipino-Americans, and women are made more actualized and real to create comprehensive reading in each script. Still, for added dramatic effect, some encounters and reactions to certain dialogues are exaggerated to deliver the message and motifs. The literary techniques were applied with caution to avoid further romanticization of the demographics involved. Additionally, as a secondary methodology, the student conducted semi-structured online and face-to-face interviews with the relatives and friends voluntarily participating. Doing so accomplishes a better plotline and guides the characters' course of action and moral compass.

3. THE ARTWORK

3.1 *Kutsilyo*

Being from a lower middle class, Mark Anthony's family is unfamiliar with the thought of "coming out" not knowing who their son is, increased with the pressure of having only one son to inherit the family name. Mary Ann forces them to reveal their gender despite not knowing what it is and using stereotypical gay men as criteria. Mark Anthony's identity insults the family because each of them believes that Catholicism and respect for the elderly reign supreme over wanting to be a forward-thinking and progressive teenager.

Kutsilyo intersects themes beyond gender identity and feminism. We know the setting to be a typical Filipino household immediately because the items displayed are deemed essential according to our culture. There is a convergence of postmodernism and gender studies in creating these subjective paradigms that are only true to some demographics: heterosexuality and Christianity. The paths are immediately considered suitable for all. No person then would conclude why a spoon represents a woman, and a fork means a man. No one is truly certain of which utensil to associate with those who identify with neither. This superstition now opens a question: what if a knife falls on the rarest of occasions?

3.2 *Ang Promise ni Pango*

The play follows Juju's first visit to his hometown, Cavite, after living in America all his life. He has little understanding of his culture, and his father, Jose, does not exert effort in showing his son how much his family from home matters. Juju comes to the grand reunion seeing banana leaves scattered across the table, people around him eating with their hands, which he critiqued as uncivilized. Juan tells

him what it has been like to live in the Philippines and how Melu, Jose's mother, has changed since he left.

Melu, representing the country, does not scold the uneducated Justin because she does not know anything, recalling no avail. She frequently mistakes the three boys for each other, accepting the fate of her near-death, wishing Jose had not spent more than half his life abroad without knowing her condition or visiting during holidays. Justin tries to understand and love his homeland for the remaining days to understand every Filipino's intricacy, down to the most nonsensical inside joke to Melu's being.

Malakas at Maganda tackles topics like immigration and discovering the Fil-Am identity. After noticing the number of children they had, the couple decided to hit them with bamboo nodes and inflict fear on the young to hide and escape from the island. As a result, those who stayed in the fireplace had tan, sunkissed skin, and those who swam across the ocean were white upon revisiting; Jose and Juju symbolize those who decided to swim.

The "brain drain" has long been a controversy in the Philippines, especially considering the amount of Overseas Filipino Workers has reached an all-time high during the past years. Due to the government and the Philippines' inability to synchronize the system with the rest of the world, underpaid, mistreated employees flee to wherever more lavish lives await. Despite Melu once agreeing to her son's immigration, she would have never expected him to forget about himself and where he belonged. Through the legend, Jose and Justin face the repercussions of being away from the Philippines and only fully understanding the effects of their departure through Melu. She chooses to accept that Western regions like the United States offer people like his son and grandson more opportunities than their motherland and regrets her generation failed to give them so.

3.3 *Pagbati*

"Puwera usog" is a saying thrown around by adults after seeing a child and being enamored by them. Beauty and Judy Mae, the town's two greatest gossipers, always stay outside Aling Bebang's store, attracting nearby people to exchange money or small tips from the owner. During the play, the duo repeatedly says the superstition to passersby like Mark Anthony and Dani, protagonists in the previous plays. They would ask questions such as, "ang ganda naman ng pinagtrabahan mo! Siguro mataas suweldo mo do'n, 'no?" and "ang laki-laki mo na, ah! Siguro maraming pinapakain sa'yo 'yang ate mo't mayaman na kayo ngayon?" Driven by the tsismis, they make the three uncomfortable, taking bits of information from them while the elder looks ahead, keeping quiet.



During his break-time, Romel visits his wife from across the street and shares a moment with their small family; this time, they force the elder to greet Romeo puwera usog. She argues that a child's wellbeing should not depend on Bathala or other deities because entrusting a living infant to fictional deities is unethical. She instead encourages them to pursue means to protect Romeo actively, like taking care of him and depending on each other as a family. Bebang states that the real evil does not reside in the intentions of every dwarf or creature, but in real people committing crimes and practicing toxicity, potentially harmful for Romeo's upbringing.

Neither Beauty nor Judy Mae expected the outburst from Bebang. They often took advantage of her silence and kindness to buy items for free from her store, Beauty for her business, and Judy Mae for her baby. They are faced with respecting Bebang or failing to lower their pride as the best tsismosas of the town.

The main sociopolitical issue in Pagbati is the crab mentality between Beauty and Judy Mae manifested to other people like Dani and Mark Anthony. According to Ambeth Ocampo (2015), the idiom comes from observing that crabs pull each other down in every bucket after being caught to prohibit one from escaping before they do. Judy Mae especially believes her fate is outside the urban poor area and will persevere to bolt out of the bucket first, even if it means betraying Beauty and leaving her behind.

3.4 *Buwayang Lubog*

As the play under the critical theory of feminism, *Buwayang Lubog* asserts that women, through lived experiences, are continually placed in detrimental situations, and not all occur at night. To alleviate the subject matter's heaviness, I, along with the interviewees' information, shall carefully insert comic relief between oversaturated circumstances (i.e., catcalling). It is of utmost significance that all participants' input or opinions during the data-gathering phase

are considered during the play's creation.

All the events- from when Dani leaves for work until she returns- are interconnected. She accepts these daily occurrences, and the production happens on the day she gives in and decides to verbalize her thoughts. Her lived experiences parallel those of the goddesses and fairies in mythologies. Long before forming modern social stratifications, men have already prevailed over

their 'counterparts,' where such concepts like a supreme Bathala stems from. However, what the contemporary Filipino can learn from this arbitrary way of thinking is how to treat women with respect and reverence.

According to Cole (1918), "The Alligator's Fruit" from the Tinguian tribe in Abra narrates how

one of two women ate the animal's food and threw it into the river, angering the alligator. He asked the villagers from the nearest town to bring him the woman. The villagers betray the alligator, telling him to open his mouth, then inserting a scorching iron rod down its throat, leading to its eventual death.

While concepts like catcalling exist, some predators would wait for a woman to pass by before looking at her and objectifying her with their comrades. Alligators also symbolize high status and power, which, according to the Standpoint Theory by Grasswick, is prevalent in modern communities.

4. ACKNOWLEDGMENTS

Accomplishing this collection is a triumph I do not celebrate alone. Among the people who have helped me are those who have given me their guidance, creativity, and time to make this submission possible. First are my parents, Ma. Ana and Joel Salamanca, who constantly encourage me to exceed my expectations and foster my love for the arts. Closely following is Ms. Jaimee Anne Esteban, my research mentor and creative writing teacher, for her patience and expertise, supporting me through every endeavor.

Being an Arts & Design student at De La Salle University is a privilege I do not take for granted. My profound appreciation to the faculty and my fellow artists—my family and driving force.

I also express my gratitude to those who have come forward to share the stories of our ancestors and theirs alike. Our indigenous people continuously resurrect parts of our identity as Filipinos otherwise unknown. Without these brave souls continuing the oral traditions of their community, this submission would not be possible.

I find it difficult to thank Kian Delos Santos for being the catalyst to my social consciousness, the reason behind this collection. His death moved me in ways unexplainable, and I would like to serve the country just as he hoped for himself, this time, through my creative works. I dedicate all my play productions to him.

5. REFERENCES

- Aguilar, Florante, director. *HARANA* - Full Feature Documentary. YouTube, YouTube, 20 Mar. 2020, www.youtube.com/watch?v=ADRFiMQqseU.
- Cook Cole, Mabel. *Philippine Folk Tales*. A.C. McClurg & Co., 1916.
- Grasswick, Heidi E. "Feminist Epistemology and Philosophy of Science: Power in Knowledge." Springer Books, 2011.
- Hega, Mylene D., et al. "Feminism and the Women's Movement in the Philippines: Struggles, Advances, and Challenges." *Freidrich Ebert Stiftung-Asia*, Freidrich Ebert Stiftung Foundation, Aug. 2018, www.fes-



3RD DLSU SENIOR HIGH SCHOOL RESEARCH CONGRESS

CREATIVE WRITING

asia.org/news/feminism-and-the-womens-movement-in-the-philippines/.

Lacson, R Edmund, "Text and Transformation: Refiguring Identity in Postcolonial Philippines" (2004). Master's Theses. 1215.

Ocampo, Ambeth. "Talangka.'" INQUIRER.net, Philippine Daily Inquirer, 12 Aug. 2015, opinion.inquirer.net/87536/talangka.

PBS. PBS Short Film Festival | In This Family | PBS. YouTube, YouTube, 12 July 2020, www.youtube.com/watch?v=vCBdpt54c2g.

Said, Edward W. "Orientalism." Pantheon Books, 1978.

TED@WellsFargo, director. The Gender-Fluid History of the Philippines | France Villarta. Performance by France Villarta, YouTube, YouTube, 3 Apr. 2020, www.youtube.com/watch?v=I6xuJu7gLe0.

TEDxTalks, director. Toilets, Bowties, Gender and Me | Audrey Mason-Hyde | TEDxAdelaide. Performance by Audrey Mason-Hyde, YouTube, YouTube, 19 Jan. 2018, www.youtube.com/watch?v=NCLoNwVJA-0.

Wheatley, Jeffrey. "U.S. Colonial Governance of Superstition and Fanaticism in the Philippines" *Method and Theory in the Study of Religion*, vol. 30, no. 2, July 2017.



Dancing Identities: Deconstructing the concept of “Finding the Filipino” in the context of the Dance Culture in Metro Manila

Bernice Mikaela D. Ignacio
De La Salle University Integrated School, Manila

Abstract: Dancing Identities is a dance film that talks about the overwhelming amount of ‘identities’ present in the world that ultimately lead to losing one’s identity and upbringing. It is an analogy to the artist’s dilemma and observations of the cultural state of the Philippines—especially in dance. This artwork aims to shed light on the possible causes of this vague sense of cultural identity and understand the phenomenon of having a natural preference for foreign culture among Filipino dancers. To fully grasp this internal conflict, the concept of “Finding the Filipino” is analyzed and deconstructed using the lenses of deconstruction and structuralism. Exploring the history of the Philippines and its present-day realities and the role of the state government in preserving culture are also essential aspects to concretize national and cultural identity. It should be noted that cultural identity is not always rooted in the pre-colonial past. Cultural identity must not be bound to a single period because it is constantly evolving and changing. The history and present-day realities that Filipinos experience constitute cultural identity and should be accepted.

Key Words: dance; culture; colonial; globalization; identity

1. OVERVIEW OF THE ARTWORK

Dancing Identities is a dance film that talks about the overwhelming amount of ‘identities’ present globally that ultimately lead to losing one’s identity and upbringing. It is an analogy to the artist’s dilemma and observations of the cultural state of the Philippines—especially in dance. Filipinos, particularly dance-artists in Metro Manila, face an internal conflict regarding their cultural identity as Filipino dance-artists and with the choreographies and works that they produce today. This identity crisis is a possible by-product of cultural imperialism, a collective experience in many Southeast Asian nations, especially in under-developed countries like the Philippines. Cultural imperialism is rooted in the significantly long history of colonial powers present in the Philippines. Examining Metro Manila in the 21st century, cultural imperialism is prominent and is manifested in colonial mentality.

To understand this internal conflict of lacking an explanation of what is ‘Filipino,’ the historical context of the Philippines, which includes the presence of colonial powers in the past until the present-day realities of culture in the Philippines, must be analyzed. Through analyzing written texts about the lived experiences of Southeast Asian nations in general, the possible causes of this vague sense of cultural identity may be addressed because the Philippines share a collective experience with its neighboring countries like Vietnam, Indonesia, Singapore, etc.

This artwork also aims to understand the trend of having a natural preference for foreign culture among underdeveloped countries like the Philippines. Therefore, the concept of “Finding the Filipino” is analyzed and deconstructed using the lenses of deconstruction and structuralism to achieve the objective of assessing what constitutes “Filipino” in the dance works we produce today.

2. UNDERSTANDING THE ARTWORK

2.1 Historical Context of the Philippines

One of Chua Beng Huat’s points in *Southeast Asia in Postcolonial Studies* is the lack of literature about nations in Southeast Asia, despite being one of the most colonized regions of the world after the Second World War (231). Even after it has already concluded, the war continues to manifest in modern-day Filipino society through the people. Chua claims, “attention to the Cold War and subsequent ongoing political instabilities unavoidably drew attention away from looking at colonialism and its aftermath” (233). With the collapse of many economies brought about by the war, economic status became the country’s symbol for power and influence. Capitalizing economies have been the focus of many Southeast Asian countries. Another subsequent effect of these events is evident in the Philippines’ desire for an independent and anti-colonial state. In a paper written by Rommel Banlaoi, he states that these anti-colonial sentiments led to a pre-maturely developed



state and government (203). Instead of having a united national ideology of the state, the formation of the State of the Philippines is rooted in these sentiments after antagonizing centuries of colonial power (Banlaoi 204). Socioeconomic, religious, and ethnic disparities among the different ethnic groups in the Philippines are intensified with globalization as policies preserve cultural heritage. Those that are beneficial for the nation are not vigorously implemented due to weak governance. Indigenous groups express their grievances and disappointment with government development projects. Their ancestral lands are greatly affected, forcing them to flee and become "refugees in their own country" (Foreman 386). They use dance as a medium to communicate these sentiments. Dance has become a "political shadow" for indigenous groups to maintain peace talks with the government effectively. With this specific example of disparity, globalization proves to be a catalyst for many socioeconomic, ethnic, religious, and political tensions among the various ethnic groups of the Philippines. A weak government is unfortunate to the development of a country as it is the sole governing body that should be implementing policies that strengthen international relations, which will help reinforce the idea of national and cultural identity.

2.2 National and Cultural Identity

Several attempts in defining Philippine national identity were made by National Artist Francisca Reyes-Aquino in her intensive research on the different folk dances in the country, as mentioned by Monica Santos in her paper, "Philippine Folk Dances: Story of a Nation." Studying and understanding the culture of the Philippines is a powerful tool in developing a sense of national and cultural identity. The works of national artists like Reyes-Aquino are motivated by a "desire to assert a national identity that is rooted in a pre-colonial past" (qtd. in Santos 3). Such motivation gives folk dance grounds to reflect different customs and traditions of a particular community, which is why the integration of these in the modern context is seen as a method of construction for national and cultural identity. However, there are some lapses and inconsistencies in this thought. These integrations of modern and pre-colonial could be termed as Folkdance, which, as stated by Namiki, "are representations of folk dances performed for the stage" (qtd. in Santos 3). Many artists today take inspiration from traditional ethnic dances and integrate them with western dance forms. An example is Agnes Locsin's neo-ethnic ballet, a fusion of ethnic dance forms and ballet vocabulary. Santos states that this kind of fusion identifies ethnic merely as a "resource material" for modern dance choreographies (27). Filipino dance pioneers like

Francisca Reyes-Aquino and Leonor Orosa-Gocquingco were most notable for preserving Filipino culture through research in dance. However, cultural identity must not be bound to a single period because it constantly evolves and changes.

2.3 Culture in the lens of Deconstruction and Structuralism

Culture is understood to have binary views. It is tied to national identity and is constantly growing and evolving. Deconstruction is understood to have binary ideas of undoing that simultaneously affirm both thoughts ("Deconstruction"). By applying this theory to National Artist Francisca Reyes-Aquino's motive of asserting national identity rooted in the Philippines' pre-colonial past, there are lapses in this case because culture is constantly growing evolving. Therefore, cultural evolution also dictates and influences people's behavior in that particular culture ("What is Cultural Evolution"). The belief that only the presence of a pre-colonial past in works produced today is what constitutes national and cultural identity lacks because it invalidates the lived experiences of the entirety of Philippine history. Analyzing 'culture' using structuralism should also be understood as having layers and structures like an onion. Structuralism, according to Nasrullah Mambrol, is perceiving the world as having structures (Mambrol). Embedded deep in Philippine culture are the manifestations of being colonized, justifying the cultural imperialism present today. The next layer is the effects of globalization on society and how it plays a vital role in the multiple presences of cultures in the Philippines, most notably in dance in Metro Manila. The outer layer of 'culture' is the general observations and manifestations of cultural imperialism that one experiences every day in Metro Manila. Thus, the linkage between culture and identity should be understood and seen in the bigger context to avoid the long history of oppression and revolution in the Philippines and what Filipinos are experiencing in present-day Metro Manila. Being a Filipino is enough to justify works and dance pieces as having the quality of "Filipino" in them.

3. THE ARTWORK

3.1 Synopsis of "Dancing Identities"

Dancing Identities revolves around the story of an unknown abstract being called *Pina*. As if moving across an astral plane of nothingness, it exists only as a concept of something that is still unclear. *Pina* faces an existential crisis about its identity and purpose of being. In a sudden moment, dim light and static noise from **The Projection** penetrate the nothingness of the astral plane, and *Pina* is left feeling



perplexed. Curious, *Pina* moves towards it, and the images suddenly become more apparent. As if watching from a movie house, flashes of Metro Manila, historical scenes, and narratives from people appear on a big screen. Collective images of the history of Metro Manila and different dance forms of people in the 21st century are shown on **The Projection**. It explores the unfamiliar environment in front of it until it arrives at a conclusion about itself and how it exists. In the end, *Pina* exists as a physical embodiment of a collective feeling based on the artist's personal experience. It is a feeling that exists inside the mind and being of the artist, which echoes the conflict between other Filipino artists, especially dance-artists.

3.2 The Artwork

3.2.1 Medium

The artist portrays this narrative through a dance film. The artwork follows conventions in a film like creating a storyline, script, and delegating some parts of the story to acting and choreography. As a choreographer, the artist explores the choreographic styles of American modern dance pioneers like Pina Bausch, Merce Cunningham, Martha Graham, street dance choreographers, and storytellers Keone and Mari Madrid.

3.2.2 Artistic Process

During the process of conceptualizing and making the artwork, the artist created a script to outline the story. Doing so gave the artist more space to conceptualize the choreography. The initial step that the artist took was to improvise the chosen music with Ideational Stimuli. Improvisation is characterized as an exploration of imagined dance forms which can then be developed as part of the choreography. The artist took inspiration from previous dance films from choreographers Keone and Mari Madrid, who are known for their distinct street dance choreographies.

3.3 Production Design

The dance film's overall visual aesthetics revolves around the spectrum dominated by cool colors like blue and purple. It has a mystic, introspective approach as the film's central conflict presents concepts beyond ordinary human knowledge. The main character *Pina* symbolizes the feeling of unfamiliarity with one's cultural identity because of the overwhelming amount of 'identities' in the present day. *Pina*, therefore, is not a physical being but rather only exists in the mind of a collective group of Filipino artists, especially dance-artists, who are faced with this dilemma. **The Projection** is the direct gateway,

acting as a window to the reality outside the inward thoughts and feelings of the people at issue.

4. ACKNOWLEDGMENTS

The artist would like to acknowledge the support from the Arts and Design Track faculty for providing their insights and suggestions on the paper from the beginning of the Term 1 Defense until the Term 2 Milestone presentation. She would like to express her sincerest gratitude to Mr. Justin Ray S. Diolazo, her research adviser and dance instructor, for his constant guidance and unending support throughout making the paper and conceptualizing the production of the dance film. Additionally, the artist would like to thank Mr. Engelbert C. Talunton, the ADT Strand Coordinator, for his constant encouragement to the entire Arts and Design Track community. She would also like to thank her partner, Jio Jose G. Alfaro, for introducing her to different dance artists that extended her knowledge of different choreographic styles in dance and guided her throughout the conventions of editing dance videos and films. Last, to her brother, Brent Michael D. Ignacio, for directing and assisting in producing *Dancing Identities* and providing extensive knowledge in filmmaking that helped the artist execute her vision through their chosen medium of expression—film dance.

5. REFERENCES

- Banlaoi, Rommel. "GLOBALIZATION AND NATION-BUILDING IN THE PHILIPPINES: State Predicaments in Managing Society in the Midst of Diversity." *Growth and Governance in Asia*, 2004, pp. 203–14. Google Scholar, apcss.org/Publications/Edited%20Volumes/GrowthGovernance_files/Pub_Growth%20Governance/Pub_GrowthGovernancech16.pdf.
- Bautista, Regina Salvaña. "Embodied Indigeneity: Translating Tradition for The Philippine Contemporary Dance Stage." *Academia*, Apr. 2017, www.academia.edu/32941839/EMBODIED_INDIGENITY_TRANSLATING_TTRADITIO_FOR_THE_PHILIPPINE_CONTEMPORARY_DANCE_STAGE
- Bautista, Regina Salvaña. "Syncretic Choreography in Philippine Dance Theater: Danced Narratives of Interstitiality and Kapwa." *Academia, Journal of English Studies and Comparative Literature*, 2019, www.academia.edu/41333098/Syncretic_Choreography_in_Philippine_Dance_TheTheT_Danced_Narratives_of_Interstitiality_and_Kapwa
- Chua, Beng Huat. "Southeast Asia in Postcolonial Studies: an Introduction." *Taylor and Francis Online*, 16 Sept. 2008, doi.org/10.1080/1368879080226637.
- "Deconstruction | Internet Encyclopedia of Philosophy." *Internet Encyclopedia of Philosophy: A Peer Reviewed Academic Resource*, iep.utm.edu/deconst. Accessed 30 Sept. 2020.



3RD DLSU SENIOR HIGH SCHOOL RESEARCH CONGRESS

DANCE

- Emerling, Jae. *Theory for Art History: Adapted from Theory for Religious Studies*, by William E. Deal and Timothy K. Beal (Theory4). 2nd ed., Routledge, 2019.
- Foreman, Kathleen. "Dancing on the Endangered List: Aesthetics and Politics of Indigenous Dance in the Philippines." *Moving History/Dancing Cultures: A Dance History Reader*, edited by Ann Dils and Ann Cooper Albright, Middletown, CT, Wesleyan University Press, 2001, pp. 384–88.
- Mambrol, Nasrullah. "Structuralism." *Literary Theory and Criticism*, 15 July 2020, literariness.org/2016/03/20/structuralism.
- Santos, Monica Fides Amada. "Philippine Folk Dances: A Story of a Nation ." *Journal of English Studies and Comparative Literature*, *Journal of English Studies and Comparative Literature*, 2019, journals.upd.edu.ph/index.php/jescl/article/view/6884
- "What Is Cultural Evolution." Cultural Evolution Society, culturalevolutionsociety.org/story/What_is_Cultural_Evolution. Accessed 30 Sept. 2020.
- "What Is Globalization? | Globalization101." Globalization 101, www.globalization101.org/what-is-globalization. Accessed 30 Sept. 2020.



BATEVATAN of the South: An Architectural Duplex Housing Plan Concept

Aaron Keith C. Perez

De La Salle University Integrated School, Biñan City, Laguna

Abstract: The artwork's concept is to design a duplex housing plan integrating the Batanes culture and tradition. However, the design locates the housing plan in the Canlubang area, which is in the CALABARZON region. The artwork's inspiration is Batanes' culture, tradition, and nature. Further, the housing plan aims to support the Ivatan culture through architectural design, have a sustainable environment, and make residents feel comfortable living in their area. The researcher sketched the duplex housing plan's design with a perspective drawing and floor plan before doing the scale and virtual model. Then, the researcher finalized the sketch of the floor plan, roof plan, and perspective drawing. The BATEVATAN of the South is a bahay na bato, but the housing plan's walling is stone cladding since it considers materials' availability. The housing plan's interior scale model is sustainable. Overall, the researcher designed BATEVATAN of the South to emphasize the culture and tradition of Batanes.

Key Words: blueprint; Ivatan culture; architectural design; aesthetic; interior design

1. OVERVIEW OF THE ARTWORK

The general concept of the artwork is to design a duplex housing plan integrating Batanes culture and tradition. The word *Bate* refers to the place of Batanes, while *Vatan* is the Ivatan people. The design focuses more on the culture and tradition of the Ivatan. However, *BATEVATAN of the South* will locate the housing plan in the Canlubang area, which is in the CALABARZON region.

Mataw refers to the method of dorado hook-and-line fishing and the process used by the fishermen. *Vanua* may be a stony beach on the edge of an eroding cliff or an area where there is a way into the coral terraces and rocky outcrops. *Mamanua* refers to "land, head to the seaport." *Payuhwan* is the term used for highly disciplined cooperative work organizations. The sea-going of *mataw* fisherman is in the summer months of March, April, and May.

These are the aesthetic designs incorporated in the duplex housing plan: Chavayan Village, Vakul, Basco Lighthouse, and Japanese Tunnel. The most common thing people view in Batanes is the Chivagan Village, where houses are made of limes. *Cha* means beautiful, and *vay* refers to the arrowroot plant known as the most distinct plant, while *vayan* means community. *Vakul* is made from cogon grass and abaca fibers. The Japanese tunnel is also referred to as the Dipnaysupuan Japanese Tunnel. The tunnel is made of cement and volcanic rock. They acted as a shelter for Japanese soldiers in 1941.

The researcher used Blueprint for floor planning and roof planning of the duplex housing plan

with precise dimensions. However, the researcher made a perspective drawing and scale model to see the overview of the house. There is a feature design of the furniture that relates to the Ivatan culture. The duplex housing plan has a sustainable design. The furniture is sustainable and made of wood and stone. The stone's duplex housing plan's functionality makes for a fresh and sturdy living since it is constructed in stone cladding and would not affect any storm surge. It takes great attention to rendering a housing structure stable enough to satisfy the resident's way of living. Further, the researcher was inspired by the aesthetics of Batanes because the environment is exquisite, and the design would function well in the Canlubang region, surrounded by trees and fresh air.

The researcher's three primary objectives are as follows:

- a. to integrate Ivatan culture into architectural and interior design,
- b. to make the housing project relevant to the people's lifestyle, and
- c. to provide easy access to rooms, especially the living and dining areas.

2. UNDERSTANDING THE ARTWORK

The researcher sketched the design of the duplex housing plan with a perspective drawing and floor plan. Then, the researcher interviewed an architect regarding the design with an initial sketch. During the interview, suggestions and comments to revise the perspective drawing and floor plan were given. The researcher continued to modify the design.



Then, the artist utilized Sketchup Layout for floor planning and roof planning. Next, the researcher printed the floor plan and roof plan. After the floor and roof planning, the researcher started the perspective drawings with the colors, finalized the design, and proceeded to do the scale model. The scale model follows the structure in the floor plan, roof plan, and perspective drawing. The last step was to create a virtual scale model since it was vital to represent a digital perspective. The production of the artwork took six weeks in total.

3. THE ARTWORK

The floor plan layout has proper spacing to prevent cramming. The dimensions and placing of the furniture are symmetrically balanced, wherein people will comfortably live without struggles or disturbance.

BATEVATAN of the South has six lights. The researcher named the lamps the Basco Lights since it is the same structure as the lighthouse in Batanes. The house's structure is stone cladding because the artist considered the availability of the stones in South Luzon. The gate of the duplex is wooden to be a sustainable and modernized housing plan.

The internal scale model of the housing plan is sustainable since the researcher's objective is environmental living.

Overall, the floor plan and scale model scale is 1:50 m since it will be enough to design the duplex housing plan. The design identifies the Batanes' culture, such as the fountain representing the stone boat shape and tunnel Japanese, the house structures made in stone cladding, and the sustainable structures of the interior house. The researcher showed how it would be sustainable by having three large windows that form rectangular shapes. There is sustainable furniture that will balance its symmetry, especially the functionality. The designs are made of wood and bamboo. Also, the duplex housing plan is a stone cladding that will make a living even more fresh and comfortable. *BATEVATAN of the South* will help the residents quickly access their rooms, especially the living area and dining area, since these are open.

4. ACKNOWLEDGMENTS

The researcher would like to thank the moderator, panelists, and adviser for helping with the revision. Thank you to the architect who commented on the sketches to be more appealing and aesthetically attractive to people. Last, thank you to the researcher's auntie who helped him design *BATEVATAN of the South*, especially building the scale model.

5. REFERENCES

- Mangahas, Maria F. "Making the Vanua Collective Fishing Technology in Batanes and an Austronesian Archetype of Society." *Philippine Studies*, vol. 56, no. 4, 2008, pp. 379–412. JSTOR, www.jstor.org/stable/42633974. Accessed 5 May 2021.
- Dizon, Eusebio Z., and Armand Salvador B. Mijares. "ARCHAEOLOGICAL EVIDENCE OF A BARANGANIC CULTURE IN BATANES." *Philippine Quarterly of Culture and Society*, vol. 27, no. 1/2, 1999, pp. 1–10. JSTOR, www.jstor.org/stable/29792430. Accessed 5 May 2021.
- Primer Media Inc. Chavayan Village in Batanes Is More than Its Stonehouses, 12 August 2019, <https://primer.com.ph/travel/2019/08/12/chavayan-village-in-sabtang-batanes-a-rich-cultural-history-beyond-stonehouses/#:~:text=Perhaps%20the%20most%20beautiful%20piece,creatively%20invented%20their%20own%20mixture.>



AnimoX: A Virtual Campus Tour of De La Salle University - Integrated School Application Prototype Development

Aaron Gabrielle C. Dichoso, Justin Daniel P. Fungo, Kyoungtae Kim,
Adam Lee John M. Sison, and Juan Rigor L. Valenzuela
De La Salle University Integrated School, Biñan City, Laguna

Abstract: De La Salle University Integrated School (DLSU-IS) conducts a Senior High School (SHS) Introductory Program to orient students on various school facilities annually. But due to the global pandemic, physical campus tours have been suspended. AnimoX is a prototype application of a virtual campus tour that serves as a substitute for a physical campus tour. The application was made in Unity3D, and its requirements were determined from the results of an interview with the Student Activities Unit (SAU). Twenty-seven SHS students in DLSU-IS were invited to test the application and give their User Experience (UX) and feedback through a Google Forms Questionnaire, which measured the following: Emotional Connection, Immersiveness, Realism, Ease of Navigation, Level of Interaction, Visual Appearance, and Communication of Information. The students generally had a positive UX, proving its acceptability as a prototype. Six points of improvement, which were the latency, user movement, environment lighting, and the visual appearance of the 3D models and UI, were addressed in the updated application. Finally, a meeting was held with the Head of the SAU to propose the application as part of the SHS introductory program, and a proposal was sent to the school administration for its approval.

Key Words: virtual campus tours; unity3D; user experience (UX); prototype development; 3D virtual environment

1. OVERVIEW OF THE ARTWORK

The De La Salle University - Integrated School (DLSU-IS) conducts a campus tour for its students every school year. First, the students are shown a video about the campus. The facilities of the campus are then explored. Finally, they are asked for feedback through questionnaires.

Campus tours help visitors engage with the campus environment (Secore 2018, p. 154). However, limitations such as time, distance, and the COVID-19 Pandemic (Centers for Disease Control and Prevention, 2021) could hinder students from attending (Guttentag, 2010, p. 643). These limitations can be addressed through virtual tours.

DLSU-IS does use virtual campus tours such as still images and video galleries (DLSU, n.d). However, these methods are unengaging (Maines & Tang, 2014). A prototype virtual tour application was developed for DLSU-IS. The prototype should illustrate a virtual environment showing the facilities of DLSU-IS and serve as an acceptable substitute to a physical campus tour. The research was conducted during the S.Y. 2020-2021 of DLSU-IS.

The virtual campus tour can be accessed online via a link provided by the researchers and is for the SHS students of DLSU-IS, as their User Experience (UX) is measured.

The development of a virtual campus tour will help with the orientation program of the SHS students of DLSU-IS. It will also benefit the Student Activities Unit (SAU) by providing an alternative campus tour and the Strategic Communications Office (STRATCOM) of DLSU-IS for the promotion of the campus (Guttentag, 2010, p. 641 & 643).

2. UNDERSTANDING THE ARTWORK

The research design is non-experimental, focusing on the responses of the participants. A Software Development Life Cycle (SDLC) model, which outlines the steps taken for software development, was adapted for the methodology. The Evolutionary Prototyping Model was used, allowing developers to implement the best-understood requirements project first (Sherrell, 2013) and then implement new requirements identified in user testing.

There are three phases: The Requirement Determining Phase, Prototype Design and Development Phase, and User Validation and Feedback Phase.

A literature review and an interview with the Head of the SAU were conducted to determine the project's requirements (SAU, n.d).



The responses were recorded and analyzed using In-Vivo coding, a data analysis method that generates codes using the participants' responses (Kauhanen et al., 2017, p. 7). After the interview, images and blueprints of the identified facilities were requested from the STRATCOM office for reference in development. The data collected in the research were kept in a password-protected flash drive that will have its contents deleted after completing the research project.

Thirty-one rooms were determined for the scope of the virtual environment. The researchers then requested the STRATCOM for a copy of the school's blueprints, including a copy of images of the rooms determined from the interview. The Milagros Del Rosario (MRR) floor plans, Learning Complex 1 (LC1), and 2 (LC2) buildings were obtained, together with 197 school images.

3. THE ARTWORK

The application was developed using Game Engine software, which provides developers the tools needed for game development (Maines & Tang, 2014). Unity is the Game Engine used as it is well-documented and offers many tools used by researchers for virtual campus tour development (Maines & Tang, 2014; Trindade et al., 2018, p. 732). Blender is used to create 3D Models as its extensive toolset allows for detailed creation (Blender Foundation, n.d.). Wondershare Filmora and GIMP are used for video and photo editing, respectively.

A Unity Project was created where the application was developed. The assets, or elements used in an application, such as 3D models and sounds, were created afterward.

The creation of 3D models used the school images and blueprints to ensure accuracy. The rooms were modeled using Unity ProBuilder and ProGrids, which allows for the fast design of structures (Unity Technologies, n.d.), while other objects were modeled in Blender.

Materials, which dictate the appearance of 3D models, were created using the Material and Shader System of Unity. Other assets, such as background music, require extensive detail. As such, many of these assets were downloaded and credited from online distributors, considering their licensing.

The assets are then imported to Unity and compressed to optimize performance. With the assets, the virtual environment was composed according to the reference images. Once the initial requirements have been met, the prototype was tested and debugged before user testing.

The SHS students of DLSU-IS were invited via email to take part in the research. Participants were then sent a web link of AnimoX, a list of instructions, and a questionnaire.

The questionnaire used five-point Likert scales and open-ended questions like the work of previous researchers to measure the UX (Bessey, 2013, p. 40-41; Kauhanen et al., 2017, p. 6; Latham et al., 2016; Mendolia-Moore, 2018, p. 67-68). The average result from each category was used to determine the UX of the student in the complementary aspects of Emotional Connection (Trindade et al., 2018, p.8), Immersiveness, the isolation of the user from the real world (Kauhanen et al., 2017, p. 3), Realism, the likeness of the virtual environment to the real world (Maines & Tang, 2014), Ease of Navigation (Latham et al., 2016), Level of Interaction (Latham et al., 2016), Visual appeal of the application (Latham et al., 2016), and Communication of Information (Latham et al., 2016).

The open-ended questions were used to gather feedback. The responses were analyzed using In-Vivo Coding and grouped into categories based on the Grounded theory methodology, a code categorization method (Strauss & Corbin, 1994, as cited in Kauhanen et al., 2017, p. 7).

A semi-formal interview was conducted with the Head of the SAU regarding the campus tours of DLSU-IS.

According to the interview, the purpose of a campus tour is for the "awareness of our distinct university" and the school's facilities. Additionally, the campus tour's effectiveness depends on the students' feedback and emotional connection, making them "smile every time they transfer to another office." It was also found that campus tours should adapt accordingly to the audience. For instance, the classrooms shown to grade-schoolers and high schoolers will differ. Finally, a virtual campus tour should be able to promote the university.

The scope of the virtual environment was then determined, namely:

1. MRR Library
2. Bookstore
3. MRR Laboratories
4. Covered Court
5. Junior High School Lab
6. Auditorium
7. Lasallian Mission Office
8. Office of Academic Services for the Integrated School
9. MRR Canteen
10. LC2 Canteen
11. Gym
12. SHS Classrooms

The interview results were then considered for the prototype's features, including the GUI, User Controls, Object Interaction System, Language



System, Audio System, Virtual Tour Guide, Room Controller, and Day-Night Cycle.

Unity supports web applications with WebGL Player and is supported by most browsers. However, the level of support may vary, with notable mentions like Apple Safari and Microsoft Edge not fully supporting Unity WebGL (Unity Technologies, 2019). The application is hosted at itch.io, which allows hosting digital content such as video games (Itch Corp., n.d.).

The prototype is accessible at <https://aarond2020.itch.io/animox> with the password, AnimoX2021.

The 3D models and materials were created using the floor plans and school images as reference. One-hundred seventy-one assets were created for the application.

Other assets were collected via online distributors. The assets were then credited in the Credits Menu. A total of 130 assets were credited for use in the application.

The school images were used as the basis for the scene composition. Lighting and sound effects were added for a more realistic, immersive, and appealing experience.

A researcher who has hosted DLSU-IS events was assigned to voice the virtual tour guide, DANNY. The descriptions of the facilities were concise, with Filipino and English versions made for the users.

Invitation emails were sent to 312 SHS students of DLSU-IS, requesting their participation. Twenty-seven SHS students accepted the invite, and 22 have tested the application and answered the evaluation form.

Results from the 5-point Likert Scale were then averaged for each question. Overall, the participants reported a positive UX in all the determining aspects.

Six points of improvement, however, were raised. These are the application latency, camera movement smoothness, movement in the virtual environment, lighting, and the visual appearance of the UI and assets.

The open-ended questions were analyzed using In-Vivo Coding. One-hundred fifty-four unique In-Vivo comments were categorized into 40 different groups and fell under eight main categories. The feedback gathered was used to improve the application.

First, the lighting issues were addressed by increasing the overall brightness of the application and editing various 3D models.

The mouse sensitivity and motion blur were lowered, and glitches were fixed.

The visual issues were also improved, like various objects not showing correctly, scaling some rooms, and adopting a minimalistic UI.

The graphics settings were adjusted to lower latency and improve quality. Occlusion culling, a process where objects not visible are disabled, was implemented to improve performance (Unity Technologies, 2021), like the smart loading process used by Racz & Zilizi, (2019, p. 4).

The interaction system was made easier to understand by changing the shape of the indicator.

Then, subtitles were added to DANNY, and a request was sent to the school administration to use the virtual tour video of the school for the Automated Tour Mode.

Finally, another interview with the Head of the SAU was conducted to present the application and to propose its implementation in the SHS introductory program. Additional feedback was given for improvement, which will be addressed in future updates, and a proposal letter will be sent to the STRATCOM Office to confirm the proposal.

In conclusion, AnimoX was developed to overcome the limitations of the current campus tour program of DLSU-IS. The prototype allows SHS students to explore the facilities of the campus online in a virtual environment. The UX of the students was measured and determined to be overall positive, proving that the prototype can function as an alternative to the traditional campus tour. Finally, the results of the evaluation of the students were taken into consideration to improve the application further.

4. ACKNOWLEDGMENTS

The research team would like to express appreciation for the SAU and STRATCOM Offices of DLSU-IS for their assistance in determining the phase of the research process. Additionally, the research team would like to thank their research adviser, Ms. Myrta Torres, and research mentors, Mr. Errol Bantayan, Ms. Leah Madrazo, and Dr. Kerry Cabral, for their guidance and support throughout the research.

5. REFERENCES

- Bessey, S. (2013). Virtual 3D Environments: Implementations of 3D Environments for Virtual Tours and Online Communication. https://scholarworks.rit.edu/cgi/viewcontent.cgi?referer=https%3A%2F%2Fscholar.google.com%2F&httpsredir=1&article=7304&context=theses&fbclid=IwAR00_XHieDKnsgTCQWAduecFlrHZr6uHTKfncgkS6JIXOTmBCXk4kCPTBRQ
- Blender Foundation. (n.d). Home of the Blender project - Free and Open 3D Creation Software. <https://www.blender.org/>
- CampusTours Incorporated. (n.d.). CampusTours – Interactive Virtual Tours and Campus Maps. <https://campustours.com/>
- Chou, T. & ChanLin, L. (2012). Augmented reality smartphone environment orientation application: a case study of the Fu-Jen University mobile campus touring



3RD DLSU SENIOR HIGH SCHOOL RESEARCH CONGRESS

DESIGN AND APPLIED ARTS

- system. *Procedia - Social and Behavioral Sciences*. 46, 410-416.
https://www.researchgate.net/publication/257715602_Augmented_Reality_Smartphone_Environment_Orientation_Application_A_Case_Study_of_the_Fu-Jen_University_Mobile_Campus_Touring_System
- Centers for Disease Control and Prevention. (February 26, 2021). COVID-19 Overview and Infection Prevention and Control Priorities in non-US Healthcare Settings. <https://www.cdc.gov/coronavirus/2019-ncov/hcp/non-us-settings/overview/index.html#background>
- De La Salle University (n.d). DLSU-IS_Student Activities Unit. Retrieved September 16, 2020, from <https://www.facebook.com/dlsu.is.sau/>
- DLSU Laguna Campus. (n.d.). <https://www.facebook.com/DLSULagunaCampus>.
- Guttentag, D. (2010). Virtual reality: Applications and implications for tourism. *Tourism Management*. 31(5), 637-651.
https://www.researchgate.net/publication/223816155_Virtual_reality_Applications_and_implications_for_tourism.
- Itch Corp. (n.d.). About itch.io. <https://itch.io/docs/general/about>.
- Kauhanen, O., Vaataja, H., Turunen, M., Keskinen, T., Sirkkunen, E., Uskali, T., Lindqvist, V., Kelling, C., & Karhu, J. (2017). Assisting Immersive Virtual Reality Development with User Experience Design Approach. In *Proceedings at the 21st International Academic Mindtrek Conference*, pp. 127-136, September 2017. https://www.researchgate.net/publication/319926160_Assisting_immersive_virtual_reality_development_with_user_experience_design_approach/link/59d742e3a6fdcc52acae3d73/download.
- Latham, K., Hurst, W., Shone, N., El Rhalibi, Abdennour., & Pan, Zhigeng. (2016). A Case Study on the Advantages of 3D Walkthroughs Over Photo Stitching Techniques. <http://researchonline.ljmu.ac.uk/id/eprint/5115/1/ICVR-V-2016-Accepted.pdf>.
- Maines, C. & Tang, S. (2014). An Application of Game Technology to Virtual University Campus Touring and Interior Navigation. http://researchonline.ljmu.ac.uk/id/eprint/327/1/DeSE2014_final%28Camera%20Ready%29.pdf.
- Mendolia-Moore, T. (2018). The College Path: A Virtual Tour. http://broncoscholar.library.cpp.edu/bitstream/handle/10211.3/208084/Mendolia-MooreTracy_Project2018.pdf?sequence=3
- Mojang Synergies AB. (n.d.). Get Minecraft | Minecraft. <https://www.minecraft.net/en-us/get-minecraft>
- Rącz, A., & Zilizi, G. (2019). Virtual Reality Aided Tourism. In *Proceedings of the Smart Cities Symposium Prague*, pp. 1-5, Prague, Czech Republic, May 23-24 2019. https://www.researchgate.net/publication/335364582_Virtual_Reality_Aided_Tourism
- Saad, A. & Shaharin, S. (2016). Evolutionary prototyping model. *International Journal of Advanced Computer Science and Applications*. 7(4). https://www.researchgate.net/figure/Evolutionary-prototyping-model-Adapted-from-11_fig6_301945976
- Secore, S. (2018). Significance of Campus Tour Visitations to College Choice And Strategic Enrollment Management. *Strategic Enrollment Management Quarterly*. <https://onlinelibrary.wiley.com/doi/full/10.1002/sem3.20114>
- Sherrell, L. (2013). Evolutionary Prototyping. *Encyclopedia of Sciences and Religions*. https://link.springer.com/referenceworkentry/10.1007%2F978-1-4020-8265-8_201039
- Strauss, A., & Corbin, J. (1994). Grounded theory methodology: An overview. In N. K. Denzin & Y. S. Lincoln (Eds.), *Handbook of qualitative research* (p. 273-285). Sage Publications, Inc.
- Tiangco, M. (2020). UST to launch virtual campus tour for freshmen in Minecraft. *Manila Bulletin*. Retrieved 8 September 2020, from <https://mb.com.ph/2020/08/25/ust-to-launch-virtual-campus-tour-for-freshmen-in-minecraft/>
- Trindade, Y., Rebelo, F., & Noriega, P. (2018). *Tourism and Virtual Reality: User Experience Evaluation of a Virtual Environment Prototype*. Design, User Experience, and Usability: Users, Contexts and Case Studies, 730-742. https://www.researchgate.net/publication/325520781_Tourism_and_Virtual_Reality_User_Experience_Evaluation_of_a_Virtual_Environment_Prototype
- Unity Technologies. (March 19, 2018). Getting started with WebGL development. <https://docs.unity3d.com/Manual/webgl-gettingstarted.html>
- Unity Technologies (n.d.). Occlusion Culling. <https://docs.unity3d.com/Manual/OcclusionCulling.html>
- Unity Technologies. (n.d.). Probuilder. <https://unity3d.com/unity/features/worldbuilding/probuilder>
- Unity Technologies. (September 14, 2018). WebGL Browser Compatibility. <https://docs.unity3d.com/Manual/webgl-browsercompatibility.html>
- Vidal, E. Jr., Mendoza, M., Samaco, J., Santos, Diy, W., Casano, J., Agapito, J., & Rodrigo, M. (2018). Igpaw: Loyola - Design of a Campus-Wide Augmented Reality Game Using MAGIS. In *Proceedings of the 26th International Conference on Computers*, pp. 589-594, 2018. <https://archium.ateneo.edu/discs-faculty-pubs/55/>



Valor: An Integration of Character Design in Creative Wears for Icons in the time of Pandemic

Mikaella Kimi S. Reyes

De La Salle University Integrated School, Manila

Abstract: The COVID-19 pandemic took countless lives. The artwork focuses on creating creative wear inspired by the people recognized as icons during the pandemic. Valor expresses the significance of feminism to women icons, heroes, and prominent personalities. The artwork also values the conservation of the environment through the utilization of sustainable fashion and recycled materials. The pieces share common materials and elements. They are built with colors fully related to each concept. The hero identity depicts power, peace, purity, and impact. To better understand the subject and approach of the study, the researcher conducted a survey among De La Salle University Senior High School students. The data reflected on the oppression experienced by women. This artwork mainly depicts heroes of this generation, people who serve the nation tirelessly and who sacrificed their lives even while facing danger.

Key Words: frontliners; COVID-19; sustainable; character design; creative wear

1. OVERVIEW OF THE ARTWORK

Valor is a collection of creative wear with powerful and colorful vitality that represents the abilities of the icons during the pandemic. Each design brings out innovative and heroic features that offer awareness to society. The identity of this collection is the connectivity between different cut-out cloths and up-cycled materials to build one entire piece that symbolizes the unity it brings to create a powerful message. There will be a futuristic headdress for every design representing each profession and convey a heroic element to the whole look.

Couture or creative fashion is rarely seen in the public. This paper is a chance for people to have exposure to it. Hence, the looks are inspired by character design combined with creative wear because both can create a more outstanding product and transform it into a more eye-catching view. In addition, the artist is inspired by heroic character designs not just because they are also heroes but also because of their exaggerated concept.

Heroes are known for their muscular and strong character, which mainly depicts only men. Women are commonly victimized by violence and discrimination. The collection considers women as inspiration to the community for their hard work for an extended period and continuously fighting for women's empowerment.

2. UNDERSTANDING THE ARTWORK

2.1 Postmodern Feminist Theory

Feminism challenges the idea of men being way inferior to women (D'Alleva as stated by

Wollstonecraft 60-61). According to Wollstonecraft, if women were less capable than men, "it was only because they were poorly educated and had limited opportunities, not because of any inherent or natural difference in ability" (61). Postmodern feminism is embedded from poststructuralism, postmodern philosophy, and French feminist theory, which is concurrently emerged (Sands and Nuccio 490). It is a combination of feminism and postmodernist theory that allows for questioning within and outside of feminism, which develops feminist scholarship. It also gives the lens of "gender" and different issues permanently to feminism to the body of postmodern scholarship. Postmodern feminism recognizes that woman is a cultural construct that has deconstructed the classification of "women," which only a few women identify. Postmodern feminists argue the need to specify about women that they are talking about to avoid such speculations. For this, an individual can speak about specific "women" instead of universal "woman." Nonetheless, either a feminist is open-minded, socialist, comprehensive, or has another viewpoint. She aims to fight oppression by changing the social and political orders (Sans and Nucio 492).

Further, it can successfully fight domination and oppression by shifting approaches as it changes women's statuses.

2.2 Feminist Social Work Theory

Feminist social work theory aims to develop women's welfare by associating their issues and frequently boundless private misery with their social status and position. Dominelli states that feminist social work as a construct includes the experience of the world of women as a fundamental principle by



focusing on the relationship between the position of the woman and her predicaments that responds to her necessities, builds democratic relations in client-worker interactions, and marks structural inequalities (7). Frequently, women are members of social services in the role of mothers or carers of older people. From the criminal justice system perspective, women are often the center of intervention because they are relatively partners of delinquent males (Orme 218). Likewise, given that the frontline humanitarian workforce is essentially built up of women, their needs and concerns must be sufficiently represented and be prioritized in organizational policies and action plans. Eventually, it is necessary to address gender biases to promote professional standards and culture, which raise the position of female humanitarian staff to secure the specific needs and insights, and that fosters women's leadership and equal participation in the decision-making of the society (Sharma et al. 2).

2.3 Inequality in Gender Role of Heroes

Superheroes present as an ideal example in which their representation may translate ideas about a comprehensive range of societal norms and values, considering those associated with masculinity and femininity. Baker and Raney have found that male superheroes outnumbered their female counterparts. Female superheroes are assumed to be slimmer in physical characteristics, wearing more revealing clothes, more human-like features, and more to be presented as a team member than a leader. Further, female superheroes are anticipated to be emotional, attractive, jealous, warm, romantic, sensitive, etc. (28). There are significant differences in stereotypical attributes between genders in superheroes and characters. Miller et al. stated that there were still twice as many males as females (par. 34). These portrayals may tell the viewers that women are not important and less likely to be heroes than men (qtd. Miller et al. 7).

2.4 System of Signs/Semiotics

Although almost anything has the potential to be a sign, it can only function as a sign if it is interpreted as a sign. There are social bases of profeminist attitudes that connect within the aspects of postmodern feminism semiotics that is greatly based on men's and women's attitude towards feminist goals. The female employment experience, family lifestyle, socioeconomic status, religion, residence, age, and political affiliation are symbolisms that have influenced society within women (Banaszak and Plutzer 31-33). These aspects emphasized the expected attitude of the community towards women, which signifies their importance and feminist values. Precise language and framework for understanding

multifaceted connections between image and society and image and viewer, and for understanding not only what works of art mean but the artist, viewer, and culture at large go about creating those meanings are essential (D'Alleva 28-29).

2.5 Creative Wear

Creative wear, also known as "Wearable Art," embraces brand new improvements in fiber-textile arts. It exists as an original creative artistic implementation field beyond the fashion and textile industries. The artist or designer could transform emotions, thoughts, culture, and form knowledge into three-dimensional products using textile and many other materials. Creative is created in textile or art studios using fabric manufacturing techniques, ethnic clothing renditions, and distinctive manufacturing methods. The pieces can be named similar to different artworks; it also has themes and forms of creative implementation (Odabasi par. 1-2).

Art expresses ideas through the integration of materials with analytical and intuitive feelings. Clothing has always been used as a form of communication defining one's own identity. Garments become a natural extension of the body and mind surrounding the figure with color, texture, and pattern. Wearable art invites people to be involved with the artwork and share the experience of the artist's creation because most of the time, art does not require physical interaction (Garver par 1).

2.6 Other Methodologies

A survey was conducted among DLSU Senior High School (SHS) students about their basic knowledge about the visualization of frontliners during the pandemic and its connection to being heroes of today's generation. The survey is to solidify the idea in conducting the final output and way of thinking about heroes and frontliners generally. The artist wants to capture more audiences by knowing their view of points and opinions about frontliners, heroes of the society, and their understanding of Feminism to signify the awareness that this output will offer. Further, the participants' answers contributed to adding up to the elements and essential details of the final artwork.

The survey, which contained multiple-choice questions about the descriptive characteristics that would fit the given three concepts of frontliners, was answered by 57 participants. The participants also had a chance to add answers other than the given choices, and with this, it better determined the visualization of these icons' appearance.



3. THE ARTWORK

3.1 “Alexa” (*Medical Worker*)

Alexa, also known as the defender of humanity, revolves around the aesthetics of a medical worker. The concept uses denim and patched works. The cropped front of the coat with the long attached garment is the primary representation. The detailed lower apparel (jeans) with an attached red transparent raincoat shows accent and identity. Last, the headdress symbolizes the use of a face shield and mask during the pandemic; it has a futuristic type of wired material that mainly features the captivating look from the adaptation of the superhero concept.

3.2 “Catrina” (*Cleaning Service Worker*)

Catrina is known for her purity that focuses on a cleaning service crew (e.g. janitor, caretaker, etc.) concept that is also in full gear to maintain its image and character. It has a cleaner look into it with fewer elements and features but still captures the goal of a hero characteristic. It has a sleeveless collared short jumpsuit attached with a string of puffy gloves, accompanied with a mini belt bag for the supplies used in the job, and accessories with rubber-like boots with accents of plastic flashes on it. Last, the chained type of mask symbolizes the criss-cross-type face shield used during the pandemic; it has a futuristic kind of wired material to show the heroism element.

3.3 “Grace” (*Grocery Clerk*)

Grace is a name that conveys the word “blessings.” This look is about a grocery clerk’s uniform. The first piece consists of a cropped puffed long sleeve for the innerwear and topped with a dress type of apron, patched with cut-out cloths together with a denim corset around the waist area. The headdress symbolizes the face shield and the mask worn during the pandemic, and a denim type of socks worn together with the boots brings a more intense look.

4. ACKNOWLEDGMENTS

The researcher would like to acknowledge the help and support of her research mentor and adviser throughout creating this research. The artist sincerely expresses gratitude to Mr. Kerwin Octavo and Ms. Elle Dumalaog for their invaluable guidance and supervision. She would also like to acknowledge the unending support of her fellow ADT batchmates, who provided comments, suggestions, and positive feedback for the success of this project.

5. REFERENCES

- Anne D Alleva “Methods and Theory Hasenmueller”, C. Panofsky, Iconography, and Semiotics. *The Journal of Aesthetics and Art Criticism*, 1978, 36(3), p.289. doi:10.2307/430439
- Baker, Kaysee and Raney, Arthur. “ Equally Super? : Gender-Role Stereotyping of Superheroes in Children’s Animated Programs” vol. 10, no.1, pp. 25-41, Department of Communication, Florida States University, DOI: 10.1080/15205430709337003
- Banaszak, Lee and Plutzer, Eric. “The Semiotics of Premature Burial: Feminism in a Postfeminist Age” *Signs: Journal of Women in Culture and Society*, 29 (4), 31-33, doi:10.1086/383492
- Dominelli, Lena. “Feminist Social Work Theory and Practice.” In: *Camping J. Palgrave*, London, 2002, p.7 , https://doi.org/10.1007/978-0-230-62820-5_1
- Ebert, Teresa. “The ‘Difference’ of Postmodern Feminism.” *College English*, vol. 53, no.8, 1991, pp. 886-887, doi:10.2307/377692
- Garver, Elizabeth. “Wearable Art”. *Rochester Institute of Technology*, 1982, p. 1, <https://scholarworks.rit.edu/cgi/viewcontent.cgi?article=4414&context=theses>
- Godard, Barbara. *Feminism and Semiotics*, *Semiotic Review of Books*, vol 13.2, 2003, p.1
- Maitem, Rosa “Stories from Frontliners” *Unicef*, Aug. 2020, <https://www.unicef.org/philippines/stories/stories-frontline>
- Miller, Monica et al. “Gender Differences in Movie Superheroes’ Roles, Appearances, and Violence” *A Journal of Gender, New Media, and Technology*, no. 10, 2016, <http://dx.doi.org/10.7264/N3HX19ZK>
- Odabasi, Sanem. “A Design Method on Wearable Art”. *International Textiles & Costume Congress*, 2015, pp. 1-2, *Between Worlds Innovation and Designs in Textiles and Costume*.
- Orme, Joan. “Feminist Social Work” In: *Adams R., Domineli et.al., Palgrave London*, 1991, p. 218, https://doi.org/10.1007/978-1-349-14400-6_18
- Sans, Roberta and Nuccio, Kathleen. “Social Work”, vol. 37, 1992, pp. 489-494, <https://doi.org/10.1093/sw/37.6.489>
- Sharma, Vandana et al. “Prioritizing vulnerable populations and women on the frontlines: COVID-19 in humanitarian contexts” *Int J Equity Health*, 2020, p. 2, <https://doi.org/10.1186/s12939-020-01186-4>
- Wolff, Kristina. “Postmodern Feminism” *The Blackwell Encyclopedia of Sociology*, 2007, pp 1-4, doi: 10.1002/9781405165518.wbeosp067
- Xu, Zhe, et al. “Pathological findings of COVID-19 associated with acute respiratory distress syndrome” *The Lancet Respiratory Medicine*, 2020, pp 1-2 doi: 10.1016/S2213-2600(20)30076-X



Home of Hope: Enhancing Interior Spaces to Cultivate a Sense of Belonging and Cultural Identity Within an Orphanage

Juliana Martina C. Mangahas
De La Salle University Integrated School, Biñan City, Laguna

Abstract: A child's psychological development affects how they will function in society in the future. During their early years, children need to be exposed to certain values such as self-identification, sense of belonging, and ethnic involvement, all of which are usually instilled through parenting practices. An orphan's lack of familial relationships negatively affects their psychological development. The purpose of this study is to create an opportunity for orphaned children to build more meaningful connections within their environment by enhancing the interior spaces of an orphanage's communal area. Through the analysis of past designs and literature and insights from interviews with interior designers, the researcher implemented a strong presence of Filipino culture in the interior design of her proposed communal area. Promoting one's cultural identity instills a greater sense of belonging and enhances functionality and aesthetics, creating a holistic and enriching environment.

Key Words: interior design; orphanage; cultural identity; child development; sense of belonging

1. OVERVIEW OF THE ARTWORK

The researcher designed an orphanage's communal area to promote children's social, psychological, physical, and cultural well-being. The child's need for a sense of belonging and stable relationships are the leading causes that the researcher wished to address. The researcher implemented Filipino designs within the space to reflect the children's belongingness to the Philippine community.

2. UNDERSTANDING THE ARTWORK

The researcher studied literature about the status of orphaned children in the Philippines and discovered particular needs that should be addressed in the design of the communal area. To integrate Philippine culture within the space, the researcher also consulted and interviewed several interior designers experienced in the Filipino interior design style.

3. THE ARTWORK

The overall design of the communal area was done through various sketches such as a floor plan layout, sectional elevation layout, and perspective drawing done in mixed media. A scale model has also been created to portray the finalized design wherein the Sintra board was used as the primary material. Various textiles such as wicker, sackcloth, and abaca were used to symbolize the traditional design elements found in Philippine culture. Several furniture pieces were inspired by the traditional *Capiz*

windows, *Butaca* lounge chairs, baskets, and local designs. Wood is also seen throughout the design as it is inspired by the *Narra* tree and lumber wood. A color palette of red, yellow, blue, and green in subtle hues dictated the overall design to cater to the children's need for stimulation while maintaining its pleasing effect on the eye.

4. ACKNOWLEDGMENTS

The creation of this artwork will not be made possible without the people who have helped the researcher along the process of this study. The researcher would like to thank her adviser, Ms. Virginia Lacsamana, and her mentor, Mr. Fernando Lacson Jr., for their overwhelming amount of support and dedication to guiding the researcher to success. This study would also not be made possible without the researcher's friends who were there by her side to continually lift her spirits during times she thought she would never overcome. Last, the researcher would like to thank her family for being the inspiration behind the creation of this study and the reason for her love for the arts.

5. REFERENCES

- Cdc.gov. 2020. Well-Being Concepts | HRQOL | CDC. [online] Available at: <<https://www.cdc.gov/hrqol/wellbeing.htm>> [Accessed 30 July 2020]. "Communal Area". Law Insider, 2020, <https://www.lawinsider.com/dictionary/communal-areas>. Accessed 3 Nov 2020.
- Department of Social Welfare and Development. Revised Standards On Residential Care Facilities. DSWD, 2007,



- https://www.dswd.gov.ph/issuances/AOs/AO_2007-011.pdf. Accessed 22 Sept 2020.
- EPGJr., D., 2020. Interior Design. [online] Piid.org.ph. Available at: <<https://www.piid.org.ph/interiordesigner.html>> [Accessed 30 July 2020].
- Furunes, E. "Project Streetlight Tagpuro". BluPrint Magazine (2017).
- Khanbabaei, Anahita. "Designing Orphanage With The Approach Of Creating Sense Of Belonging To The Environment." (2016).
- Lontoc, Jo. "Uplifting Lives Through Interior Design". University Of The Philippines, 2020, <https://www.up.edu.ph/uplifting-lives-through-interior-design-3/>.
- Pañares, Alice A. "Observations on the Filipino Child and His Art." *Philippine Studies* (1979): 483-504.
- Pitre, Natalie J., and Veronika Bohac Clarke. "Cultural Self-Study as a Tool for Critical Reflection and Learning: Integral Analysis and Implications for Pre-Service Teacher Education Programs." *Multicultural Instructional Design: Concepts, Methodologies, Tools, and Applications*. IGI Global, 2020. 769-793.
- Raman, Shanti. "Cultural identity and child health." (2006): 231-234.
- Taff, P. "Kanlungan: An Architectural Thesis". Journeyman International Inc. (2014).
- Umeda, Yasushi, and Tetsuo Tomiyama. "Functional reasoning in design." *IEEE expert* 12.2 (1997): 42-48.
- UNICEF. 2020. Orphans. [online] Available at: <https://www.unicef.org/media/media_45279.html> [Accessed 30 July 2020].
- Vergara, J., Angeles, L., Pagkalinawan, A. and Villafranca, M., 2018. Uncertain Living: Challenges of Orphans in the Philippines. *JPAIR Multidisciplinary Research*, 33(1).
- Vergara, John Mark, et al. "Uncertain Living: Challenges of Orphans in the Philippines." *JPAIR Multidisciplinary Research* 33.1 (2018).
- Winchip, Susan M. *Sustainable design for interior environments* second edition. A&C Black, 2011.
- Zweigle, A. "An Exploration of Relationships and Potential for the Growth of Love: A Grounded Theory Study in Orphanage Q". Wesleyan-Holiness Digital Library (2017).



Prepared for Nature's Unknown: An Architectural Solution for Enhancing Safety and Comfort in Homes in the Philippines

Samantha Isabel E. Chavez
De La Salle University Integrated School, Manila

Abstract: Natural disasters are a common phenomenon in human lives. We hold on to the fundamental aspects of natural survival: food, water, shelter, and other basic survival needs. In terms of combatting weather calamities, shelter is a key factor. It is important that this shelter is resilient to preserve the inhabitants' safety and cater to the inhabitants' needs such as water, electricity, etc. The Philippines has its own set of natural disasters just like any other country. But in terms of the weather system, the Philippines is a tropical wet and dry country with extreme weather conditions. A drastic issue with what comes after heavy rains are natural disasters like floods. Needed components for an architectural solution that would tackle the needs of a home to be able to withstand calamities would be to research the country's environmental state as the Philippines is a tropical country that commonly has typhoons, rains, and the remains of the phenomena. The study must also consider modern solutions to the design, such as anti-flood measures, sturdier material for weather, design solutions that tackle interior cooling, and even comfort as a factor contributing to people's needs.

Key Words: architectural solution; natural disasters; weather calamities; safety; modernist theory

1. OVERVIEW OF THE ARTWORK

Weather calamities in the Philippines can easily be detected by the country's weather organization called PAGASA (The Philippine Atmospheric, Geophysical, and Astronomical Services Administration). With the help of PAGASA, the country can prepare for upcoming calamities. Safety, however, is not always guaranteed. The Philippines, being located on the equator, handles warm and humid temperatures for most of the year. Towards the end of the year, the Philippines welcomes harsh weather, including monsoons, typhoons, hurricanes that hurl powerful winds, and heavy rains, as the country is located in the south-eastern area of Asia next to the Pacific Ocean. The Philippines is not exactly as prepared as it should be with the proper solutions to combat these situations. It does not have functional drainage systems in several areas, making those areas susceptible to floods and floating debris, which put lives at risk. With these circumstances, the structures must be specially designed to be resilient to the different events that the world's natural order pushes upon to the country.

The designer came up with the solution of creating disaster-prepared homes in the Philippines to combat typhoons and flood control issues—homes that satisfy the needs required to achieve living through a disaster with proper survival and safety factors.

In consideration of the dilemmas with weather ongoing in the Philippines, the purpose of this

research is to address the complications that involve house designs and how much they should accommodate to the factors that a shelter should provide, primarily with safety and comfort.

The research aims to answer the following questions:

1. Does the Philippines require architectural design solutions and strategies to counter the weather and climate disturbances in the country effectively?
2. What should the design include to combat the weather and climate complexities that the Philippines is currently facing?
3. What is the ideal type of materials for building a resilient house in the Philippines?

2. UNDERSTANDING THE ARTWORK

Resources that support the proposal of this design are essential to carry on the idea that modern solutions are not what only one person is doing but what many architects are aiming to achieve. In the present, different organizations are looking to contribute solutions from actual planning to financial support. Architecture usually reflects on the construction site and how the design considerations include various factors (geographical, functional, etc.) that make the final design. When weather phenomena occur, and many are affected, we take action in helping one another no matter how far the



communities are. This is an example of when people and communities come together to help one another.

In architecture, modernism is a style based on new and innovative ideas that integrate modern technology and materials such as reinforced concrete, steel, metal, glass, etc. Additionally, the form of the design must be functional with fewer embellishments.

The designer interviewed five experts in architecture on the Philippines' weather conditions, the current state of structures in the Philippines, and how well the country handles natural disaster risks in the field of architecture.

The designer gathered as much information as needed for the benefit of this study and took the opportunity to ask for their expertise and insights.

3. THE ARTWORK

The artwork was produced through visual art media via drafting and floor plan sketching. Along the process, the designer applied different methods, concepts, and studies from different situations, the goal of this research being to design and strategize a structure that compensates for the various environmental catastrophic events aligned with weather and climate as well as other aspects that must be included in the structure.

With this, the designer included these design ideas and solutions:

1. **An elevated foundation is used to adapt to flooding in the area.** The house came to be in an elevated figure to adapt to any flooding circumstances. Even though flood would not typically occur in the selected region, it still is essential to consider any condition for the country that the house is set in. The Philippines' weather and climate designs are unusual, and it would never be known when the country would change in any way geographically.
2. **The alignment of the structure is angled to catch the wind to achieve cooling for the house.** The house is oriented in the north direction, so the structure will not be significantly affected by the rising and setting sun. The setting sun is known as the hottest time of the day.
3. **Multiple windows are a necessity for passive interior cooling.** Windows in the structure is an important design aspect when trying to capture possible passive cooling around the house. That said, there must be good ventilation inside a home to provide better livability of the home.
4. **The roofing is designed at a diagonal angle to provide proper shade for the structure and**

adequately clear rainwater, and avoid gathering on the surface. This avoids leaks and the risk of the roof getting destroyed. The material used is pre-painted galvanized iron long-span sheets for a cool roofing method. This would help the roof avoid absorbing heat and give cooling to the house.

5. **Specialized windows or "awnings" are applied for the structure to protect the interiors from rains adequately.** Using this type of appliance better supports the house's cooling system and enables inhabitants to keep their windows open during light rain showers.

4. ACKNOWLEDGMENTS

To my research adviser, Sir Fernando Lacson Jr., thank you for your guidance and support in my academic path.

To my mother, Maria Clarice Eufre, I am thankful for your support in the idea of my research and your acknowledgment of the times when I feel stressed. You have kept me in proper shape to push through with my daily struggles.

To my friend's father, Architect Petes Gamboa, I am truly grateful to have you as my mentor and for your help in my research. I respect your profession and appreciate your presence when I need help in the architectural field.

To those affected by the calamities of different sorts—those who persist in these difficult times, solutions will always come forth if we keep pushing and striving for the better. I thank and respect you.

5. REFERENCES

Cdc.gov. 2020. Well-Being Concepts | HRQOL | CDC. [online] Available at: <<https://www.cdc.gov/hrqol/wellbeing.htm>> [Accessed 30 July 2020].

"Communal Area". Law Insider, 2020, <https://www.lawinsider.com/dictionary/communal-areas>. Accessed 3 Nov 2020.

Department of Social Welfare and Development. Revised Standards On Residential Care Facilities. DSWD, 2007, https://www.dswd.gov.ph/issuances/AOs/AO_2007-011.pdf. Accessed 22 Sept 2020.

EPG Jr., D., 2020. Interior Design. [online] Piid.org.ph. Available at: <<https://www.piid.org.ph/interiordesigner.html>> [Accessed 30 July 2020].

Furunes, E. "Project Streetlight Tagpuro". BluPrint Magazine (2017).

Khanbabaei, Anahita. "Designing Orphanage With The Approach Of Creating Sense Of Belonging To The Environment." (2016).

Lontoc, Jo. "Uplifting Lives Through Interior Design". University Of The Philippines, 2020, <https://www.up.edu.ph/uplifting-lives-through-interior-design-3/>.



3RD DLSU SENIOR HIGH SCHOOL RESEARCH CONGRESS

DESIGN AND APPLIED ARTS

- Pañares, Alice A. "Observations on the Filipino Child and His Art." *Philippine Studies* (1979): 483-504.
- Pitre, Natalie J., and Veronika Bohac Clarke. "Cultural Self-Study as a Tool for Critical Reflection and Learning: Integral Analysis and Implications for Pre-Service Teacher Education Programs." *Multicultural Instructional Design: Concepts, Methodologies, Tools, and Applications*. IGI Global, 2020. 769-793.
- Raman, Shanti. "Cultural identity and child health." (2006): 231-234.
- Taff, P. "Kanlungan: An Architectural Thesis". Journeyman International Inc. (2014).
- Umeda, Yasushi, and Tetsuo Tomiyama. "Functional reasoning in design." *IEEE expert* 12.2 (1997): 42-48.
- UNICEF. 2020. Orphans. [online] Available at: <https://www.unicef.org/media/media_45279.html> [Accessed 30 July 2020].
- Vergara, J., Angeles, L., Pagkalinawan, A. and Villafranca, M., 2018. *Uncertain Living: Challenges of Orphans in the Philippines*. *JPAIR Multidisciplinary Research*, 33(1).
- Vergara, John Mark, et al. "Uncertain Living: Challenges of Orphans in the Philippines." *JPAIR Multidisciplinary Research* 33.1 (2018).
- Winchip, Susan M. *Sustainable design for interior environments* second edition. A&C Black, 2011.
- Zweigle, A. "An Exploration of Relationships and Potential for the Growth of Love: A Grounded Theory Study in Orphanage Q". *Wesleyan-Holiness Digital Library* (2017).



Sa Likod ng Paghahabi: A Picture Book Based on the Lumad Communities' Narratives Regarding the Prevailing Conflicts Against their Human Rights

Jasmine Fiona V. Taasan

De La Salle University Integrated School, Biñan City, Laguna

Abstract: The Lumad community is usually described as “native” because of their rich culture and beautiful traditions, but this view can contribute to the community’s systematic discrimination and existing conflicts. With this gap, the study aims to pinpoint the community’s prevailing conflicts against their human rights and spark realizations regarding the dominant definition of progress that negatively affects indigenous communities by creatively presenting Agusan Manobo narratives in a children’s picture book. The research data comes from numerous academic literature, webinars, other children’s picture books, and an interview to fully grasp the community’s perspectives. Using this research’s findings, a children’s picture book, appropriate for five-year-olds and above, is conceptualized, written, and designed featuring a young Manobo girl as the main character. The storyline outlines her joyous daily lifestyle in the community. Still, the story talks about the reality of their community lacking allies who see progress in the same manner. Using mainly landscape-oriented illustrations, the picture book argues that the imposed uniform definition of progress is not suitable for every individual and community. Another message incorporated in the output is the invitation to readers to become allies of the community by supporting them as they speak out for their human rights.

Key Words: Lumad community; Manobo ethnolinguistic group; industrialization; development aggression; picture book

1. OVERVIEW OF THE ARTWORK

1.1 Concept

The 9” x 7” picture book depicts the Lumad community’s persisting experiences of systemic conflicts harming their fundamental human rights as Filipinos and Indigenous Peoples. This prevalent issue, usually displayed as acts of ancestral land intrusion and systematic discrimination, revolves around the dominant desire for economic growth, industrialization, and globalization in areas filled with natural resources, most abundant within the Lumad’s ancestral domains. The story is centered around a young Manobo girl who is proud of her own culture and way of life. The whole plot follows her as she explores and discovers the ups and downs of being an indigenous minority. She happily practices her cultural traditions and enjoys the agriculture-inclined lifestyle of their community. However, she is faced with a situation that shows her the harsh reality of their community lacking allies who would listen and share their perspective.

1.2 Objectives

The following are the objectives of this picture book and research:

- a. to determine the reason for the Lumad’s, or specifically the Agusan Manobo’s, prevailing conflicts that violate their fundamental human rights, despite the established legal protection within the constitution titled “The Indigenous People’s Rights Act of 1997 (IPRA),”
- b. to give space for the Lumad community to voice out their narratives and experiences, which could spark conversations and realizations that the imposed uniform definition of progress does not apply to every individual and community, inspiring allies to build a definite plan of action, and
- c. to produce a children’s picture book, open to the interpretation and consumption of older audiences, that would appropriately portray the community and their experiences.

1.3 Inspirations

The artist greatly appreciated a lesson as a student when they analyzed children’s books to create



in-depth interpretations and messages that were not explicitly written in the text.

Regarding the subject matter of this research, the artist was already aware of the beautiful and rich culture the Philippines' Indigenous Peoples had, especially regarding their folk dances and weaving tradition. However, her interest in the Lumad community's situation piqued as she was exposed to *#SaveLumadSchools*, *#DefendAncestralLands*, and *#StandwithBakwitSchool*. The artist learned that the dominant perception of the community being "native" could also be a form of systematic discrimination towards the Lumads. Although she is from Laguna, she felt passion for using her capabilities and skills to support the community.

2. UNDERSTANDING THE ARTWORK

2.1 Review of Related Literature/Discourse

The Lumads' conflicts, including the Manobo Tribe, are not resolved because of the dominant desire for economic growth through industrialization in "untouched" land filled with natural resources. The community's past and current conflicts revolve around the intrusion on ancestral lands and systematic discrimination.

During the 1880s, some Lumad communities did not label the Spanish missionaries as dangerous, for they were seen as a bringer of new ideas that could be adapted locally (Marquinez et al. 34; Bernad 253). However, some tribes displayed their desire to remain free from foreign interference by opposing and resisting the Spanish colonization. This developed to them being systematically discriminated against because they were regarded as "uncivilized" and labeled as "Wild Tribes" (Perez 45; Montiel et al. 9-10).

On the other hand, the American colonial government physically took the indigenous peoples' lands by migrating, allowing corporate organizations, and imposing laws, thus displacing and dispossessing Lumad communities from their ancestral domains. The United States' active participation in the world market has also encouraged industries utilizing logs, minerals, and other natural resources (Marquinez et al. 34; Perez 45; Montiel et al. 11-13).

Since then, the government has been approving business corporations to exploit the lands in Mindanao at the expense of the Lumads' physical and cultural dislocation (Marquinez et al. 36).

Although the Lumad communities support the Moros' Bangsamoro Basic Law, they were afraid of their ancestral lands being labeled part of the Moros' property. The discussion for this law between the Muslims and the government lead to the ignorance of the Lumad communities' concerns regarding their

rights because they are seen as second-order minorities and politically weak (Paredes 3, 6-7, 9-11, 13-14; Perez 46; Montiel et al. 19, 33, 35).

Currently, the paramilitary attacks on Lumad communities precede the entry of industrial corporations, leading to the assumption of the military and the Philippine government supporting business interests in extracting natural resources from ancestral lands with funds from multinational corporations. The claim for globalization is being fulfilled, causing the neglect of the Lumads' injustices, harmed human rights and environmental problems (Perez 46, 49-50; Espiritu 45-46, 50-52, 55).

Land is a significant factor, for it is seen as culturally crucial by the Moros and the Lumads and economically essential by the State and the Moros. The Agusan Manobo's conflicts stem from the collective yearning of other groups for land abundant in Mindanao.

This conflict experienced by the Lumad community, specifically the Manobos, can be termed as "development aggression," which parallels global occurrences that deny the indigenous peoples' fundamental human rights (Gilbert & Doyle, p. 225).

2.2 Supplementary Qualitative Data

Narratives were gathered from an interview and from webinars with Agusan Manobo representatives to strengthen the arguments acquired from literature. They state that even with laws prohibiting discrimination, conflicts still exist. The Lumads are also taken advantage of by imposing contracts they do not understand because of the community's lack of social services like formal education and literacy programs. Due to this gap, indigenous-led schools were established to bring education to far-flung areas. However, these schools are accused of being "NPA breeding grounds," causing Lumad families to evacuate. They state that they are open to what industries or industrialization has to offer, for they also desire progress and development. However, they hope to redefine the common conception of progress, transforming this term into something that benefits the needs of the Lumad community and nature. They believe that "land is life" and farming is their way of asserting the justice they deserve. However, this is not supported by the NCIP, a committee formed under the IPRA and not appointed by the Lumad community themselves. They are said to use their positions to satisfy their capitalistic interests by legally allowing corporations to operate within the ancestral lands. Although the IPRA had brought benefits, like university scholarships, government misrepresentation has deemed this law to cause more harm than good because destructive actions are still being imposed in ancestral areas (Cadiang & Hayahay, 2020).



3. THE ARTWORK

3.1 Plot/Storyline

Picture books are the most appropriate artistic space for this topic because they primarily utilize visual illustrations for storytelling and usually contain 50 to 1,000 words to guide children to navigate their world (Author Learning Center). This output's target audience is five-year-olds and above. However, a more mature or older audience is also encouraged to interpret the book's concept and message. The Lumad community's prevailing conflict for human rights is an issue that needs to be addressed and acknowledged by the common public.

The book starts with a *Suyam*-inspired patterned cloth lifted by a young Manobo girl. The colors and patterns symbolize the tribe's beliefs, history, and cultural heritage, with influence from nature. The first pages will show the beauty of their cultural identity, including how the dominant perception describes their traditions and religion as "native" and "precolonial." The young Manobo girl guides the viewer to her daily lifestyle, from participating in farming activities to appreciating her surroundings. As she learns and contributes to the progress and development of her community's agriculture, she realizes that although it may be challenging, there is a sense of fulfillment and self-reliance from planting, harvesting, etc.

The narrative will slowly transition to the reality of what the Lumad community is experiencing. Despite characterizing their culture as beauty, the dominant perception causes the systematic discrimination of the Lumad community. Incorporating the data gathered from literature and qualitative methods, the latter part of the book will show society's desire for "Westernized" progress in the lives of the Lumad community.

The young Manobo girl finds herself near the forest until she hears a disturbingly loud and unfamiliar noise. She enters the woods to follow the sound, and the farther she goes, the brightness and warmth of the environment slowly fades. As she treks through the forest, she is met with numerous chopped-down trees, barren lands, and big machines. As she goes back to tell her friends and family, chaos takes over her peaceful home.

Feeling internal turmoil and pain, she meets with representatives she thought she could trust: an industrial worker, a military officer, and a government official. However, they'll say that "these were orders from above" and reason out that this is for the country's benefit. With these unresolved complaints, the little Manobo girl leaves their homes to find another place to stay with her family and friends.

The young Manobo girl, carrying the *Suyam*-inspired textile, travels towards their community's new farm. Their farm is shown to occupy a larger area with abundant crops, ending the story with the idea that farming is a way of protest, progress, and protecting the sacred ancestral lands.

3.2 Elements and Composition

The style used is cartoon-like, utilizing solid, defined shapes and minimal use of line art. The illustrations for the book are created in landscape orientation, specifically with the dimensions 9 inches by 7 inches, so it also highlights the environment and surroundings of the characters. Most of the book's spreads have elements of nature, making it seem that the main character is a small person within the large environment.

At the start of the book, the colors are vibrant, saturated, and warm. The spreads are filled chiefly with warm-toned reds, yellows, and greens. However, as the story progresses, the colors transition to dull, dark, and cold. The primary colors are filled with cool-toned blues, purples, and greens.

The principle of space is also used in the book's layout because it provides an area for the text and a sense of the pacing and visual depth of the spreads.

4. ACKNOWLEDGMENTS

To my research adviser, Sir Ryan Ballesteros, thank you for your support and guidance ever since the start of the academic year.

To my research mentor, Sir Hanzel Gapayao, I am grateful for your steadfast patience and enthusiasm for your students.

To Sir Carlito Amalla, I would like to express my deepest gratitude for participating in this study and imparting new information regarding the Agusan Manobo community. Our interaction has grown my motivation to learn and immerse myself in the community's culture and situation.

To the Save Our Schools Network and the ALCADDEV Lumad School, I extend my genuine appreciation for spreading awareness regarding the issues experienced by the Lumad ethnolinguistic groups. I have attended one of your webinars, and it opened my eyes to the reality and injustices that Lumads have to face every day. In any way I can, I will continue to listen and support the community wholeheartedly.

5. REFERENCES

Author Learning Center. "Understanding Children's Book Classifications – article." Author Learning Center, <https://www.authorlearningcenter.com/writing/children-s-books/w/age-groups/6212/understanding-children-s-book-classifications---article>



- Bernad, Miguel A. *The Great Island: Studies in the Exploration and Evangelization of Mindanao*. Quezon City: ADMU Press, 2004.
- Cadiang, Ken & Hayahay, Rose. *Dugang Kadasig: Pagtatanggol sa Lupang Ninuno*. Kabataan Para Sa Tribung Pilipino - Up Diliman Chapter, 31 Oct. 2020. Webinar.
- Cagoco-Guiam, Rufa & Habito, Cielito F. *Understanding Mindanao Political Economy and Culture*. Ateneo de Manila University - Institute of Philippine Culture & Department of Science and Technology - Philippine Council for Health Research Development, 30 Sept. 2020. Webinar.
- Doyle, Cathal, and Jérémie Gilbert. "Indigenous Peoples and Globalization: From Development Aggression to Self-Determined Development." Available at SSRN 2552408 (2015). Retrieved from https://www.researchgate.net/publication/278684562_Indigenous_Peoples_and_Globalization_From_Development_Aggression_to_Self-Determined_Development
- Espiritu, Belinda F. "The Lumad Struggle for Social and Environmental Justice: Alternative media in a socio-environmental movement in the Philippines." *Journal of Alternative & Community Media* 2.1, 2017, 45-59. Retrieved from <https://www.ingentaconnect.com/contentone/intellect/jacm/2017/00000002/00000001/art00004?crawler=true&mimetype=application/pdf>
- Marquinez, Jessica T., et al. *Lumad Mindanao*. Rizal Park, Manila: National Museum of the Philippines, 2020. Retrieved from https://www.nationalmuseum.gov.ph/nationalmuseum/beta/NMP%20Online%20Materials/Lumad_Mindanao.html?fbclid=IwAR2DN6gW1GoDmGZpN-ft1hnPcKzBZrn2w9sPPL7pjHEtqjtZcasFkn8AM
- Montiel, Cristina J., Rudy B. Rodil, and Judith M. de Guzman. "The Moro struggle and the challenge to peacebuilding in Mindanao, Southern Philippines." *Handbook of ethnic conflict*. Springer, Boston, MA, 2012. 71-89. Retrieved from <http://rizal.lib.admu.edu.ph/serve/12012/RUNNING%20HEAD%20The%20Moro%20Struggle.pdf>
- Paredes, Oona. "Indigenous vs. native: negotiating the place of Lumads in the Bangsamoro homeland." *Asian Ethnicity* 16.2, 2015, 166-185. Retrieved from <https://www.tandfonline.com/doi/abs/10.1080/14631369.2015.1003690>
- Perez, Jose Mikhail. "Greed and grievances: A Discursive Study on the Evolution of the Lumad Struggle in Mindanao, 2010-2019." *Journal of Ethnic and Cultural Studies* 6.3, 2019, 41-52. Retrieved from <http://dx.doi.org/10.29333/ejecs/2541>
- Republic of the Philippines. Republic Act No. 8371, Congress of the Philippines, <https://www.officialgazette.gov.ph/1997/10/29/republic-act-no-8371/>



What Lies Within: Designing a 2D Pixel Video Game to Depict Changes in Social Behavior and Physical State for Students Diagnosed with Depression during the COVID-19 Pandemic in the Philippines

Elainah Mae B. Dimaranan, and Marie Aimie K. Tanaka
De La Salle University Integrated School, Biñan City, Laguna

Abstract: This research focuses on how the COVID-19 pandemic can affect a student diagnosed with depression in the Philippines. Depression is a common mental health problem present in various parts of the world, yet the Philippines does not appropriately address this as a significant issue. Numerous Filipinos take depression lightly, and stigma about mental health is still apparent in the Philippines. With the pandemic, seeking help becomes more problematic. The purpose of this study is to break the stigma circulating depression using a 2D pixel game to immerse and educate those who take depression lightly. The researchers gathered data by interviewing two people from the DLSU Laguna campus diagnosed with depression and a psychology student and looking through various reading materials. The researchers found several factors contributing to depression; examples are social, biological, and psychological aspects shown in several references and interviews. After acquiring the needed information, the researchers detected the common factors that could cause depressive symptoms. They found out that the main reason people refused to get help is the stigma surrounding mental health.

Key Words: depression; stigmas; Philippines; COVID-19 pandemic; new normal

1. OVERVIEW OF THE ARTWORK

1.1. *Background of the Subject Matter*

Depression, also known as major depressive disorder, is a severe medical condition that adversely affects how a person feels, thinks, and behaves. It can contribute to several physical and emotional issues and impair an individual's ability to function at work and home. In the Philippines, there are plenty of people who are suffering from depression.

Most Filipinos still view depression as something that the individual should be ashamed of. This thinking has caused stigma, making it hard for those affected to seek professional help. According to research conducted about stigmas, Filipinos either overreact or completely neglect depression (Tanaka et al.). People use mental illnesses such as depression as an insult. The researchers focused on grade 12 students in the academic year 2020-2021 at the DLSU Laguna campus and on the “new normal” during the COVID-19 pandemic. There is little to no gap in the study of depression. However, there are few studies on depression during the COVID-19 Pandemic.

1.2. *Research Questions*

How can a 2D pixel video game address the situation affecting a grade 12 senior high school student studying at the DLSU Laguna campus and

diagnosed with depression? How can video games help people learn about depression? How did the student cope with their depression when they were under different types of stressful situations?

1.3. *Medium and Technique*

The artists' chosen medium is video games, and the style is two-dimensional pixel art. The artists believe video games would help people understand the subject's complexity through an immersive experience. The game's central theme is Filipino-based because the artists want their game to break the Philippines' stigma around depression.

1.4. *Significance of the Artwork*

The gameplay brings a more detailed understanding of the concept of depression. Since the theme is Filipino-based, it showcases the Filipino students' perspectives, primarily those who are struggling during the pandemic. The game benefits those who do not have a proper understanding of depression, take depression lightly, or are curious about the pandemic's behavioral and physical effects.

1.5. *Scope and Limitations*

This research covers only grade 12 ADT students from the DLSU Laguna campus in the AY 2020-2021. The researchers could not find an actual



psychiatrist due to lack of time. Still, the researchers interviewed a psychology student. There is also a lack of journal articles discussing depression among students during the pandemic based here in the Philippines.

2. UNDERSTANDING THE ARTWORK

Depression is a well-known subject among the demographic. Research conducted in 2013 studied the factors associated with depressive symptoms among university students in the Philippines (Lee et al.). Age, gender, vices such as alcoholism and smoking, closeness to their families, and religion were among the factors mentioned in this research. Their work showed that the bond of biological parents and the respondent was a significant factor.

In another research, Hammen stated that stressors are one of the main components that could lead to a depressive state (10).

Another study stated that depression could affect life quality and vice versa (Cleofas). Students who engage more in social activities could boost their mood. Another research surveyed the significant change in a graduate student's academic performance when depressed and found a relationship between the values (Licayan).

Depression is a matter that people should not take lightly. A study showed that stigmas targeted at people with mental health problems negatively impact the individual's life (Tanaka et al.). People also use derogatory terms like "baliw" and "abnoy" (Rivera and Antonio, 23). Stigmas about mental health make it hard for those who are affected to seek help.

With the information provided, the researchers planned on comparing and correlating depression when there was no pandemic to now. According to research by Sawhney et al., students who show less depressive symptoms are more likely to seek emotional support as a way of coping (270). Those with high depressive symptoms would instead isolate themselves from people. Those who exhibit high depressive symptoms also go for a maladaptive coping way, also known as self-destructive coping.

The researchers chose two students diagnosed with depression. Cinnamon had a few troubles during the observation week regarding their family, but they coped well by distracting themselves and writing in their journal. Cherry took breaks from various stressors such as school and their family.

The researchers also interviewed a psychology student. The interviewee stated that to diagnose a person with depression, they use three aspects to check if they have signs of depression; these aspects are biological, social, and psychological.

The researchers designed a 2d pixel art game wherein the player experiences lockdown due to the COVID-19 pandemic. The game is choice-based, where

the ending would depend on how the player manages. The player is a gender-neutral student who exhibits signs of depression. The enemy, Depression, hinders the player's tasks and makes their world darker. The control for this game is a point-and-click style side scroller RPG. The player has the option to do or not do their works on time. The implications for each job can affect the player, increasing the chances of feeling uneasy. The player's house is the setting of the game. Players should click the left mouse button to interact with tasks such as the mini-games, duties, and choices provided.

3. THE ARTWORK

3.1 Art Process

The artist used Clip Studio Paint to portray their idea for their game. The artist sketched their characters by using the pencil tool before finalizing. The artist also drew guidelines to make sure that the perspective is correct. After creating the sketches for the characters, background, and items, the artist started turning the drawings into pixel art. After the artist did the outline, they started laying out the flat colors and adding details. The artists did the same process with the rest of the elements, such as the house layout and other designs.

The artist wanted a simple UI that does not have many elements not to distract the players. The artist wanted to make the phone and tasks design easier to understand, so they changed the phone design to be an actual phone and the tasks icon to be a paper with lists.

Depression is a severe medical condition that adversely affects how a person feels. A 2D pixel game can help address the situation by giving an immersive experience. The researchers believe that their paper would help those who want to seek help or those whose peers could not understand the difficulties of depression. This paper focuses on breaking the stigmas present about mental health in the Philippines.

4. ACKNOWLEDGMENTS

We want to thank the participants of this research for giving us the information needed to find the results of our studies. We would also like to thank our research adviser, Sir Ryan Edward Ballesteros, and our research mentor, Sir Hanzel Gapayao. Elainah Dimaranan would like to thank Philip Bartolabac for helping her with her artwork. Aimie Tanaka would like to thank Martin Lontoc for helping her with the game's title and writing.



5. REFERENCES

- Cleofas, Jerome Visperas. "Student Involvement, Mental Health and Quality of Life of College Students in a Selected University in Manila, Philippines." *International Journal of Adolescence and Youth*, vol. 25, no. 1, 2019, pp. 435–47. Crossref, doi:10.1080/02673843.2019.1670683.
- Hammen, Constance. "Risk Factors for Depression: An Autobiographical Review." *Annual Review of Clinical Psychology*, vol. 14, no. 1, 2018, pp. 1–28. Crossref, doi:10.1146/annurev-clinpsy-050817-084811.
- Lee, Romeo B., et al. "Factors Associated with Depressive Symptoms among Filipino University Students." *PLoS ONE*, edited by Hamid Reza Baradaran, vol. 8, no. 11, 2013, p. e79825. Crossref, doi:10.1371/journal.pone.0079825.
- Licayan, Richard Ijao. "A Survey of Depression Among Graduate Students and Their Academic Performance." *SSRN Electronic Journal*, 2009. Crossref, doi:10.2139/ssrn.1915051.
- Ph.D., Farrell Patricia. *It's Not All in Your Head: Anxiety, Depression, Mood Swings, and MS*. 1st ed., Demos Health, 2010.
- Rivera, Ana, and Carl Antonio. "Mental Health Stigma Among Filipinos: Time For A Paradigm Shift." *Philippine Journal of Health Research and Development*, vol. 21, 2017, pp. 20–24. Researchgate, www.researchgate.net/publication/326412761_Mental_Health_Stigma_Among_Filipinos_Time_For_A_Paradigm_Shift.
- Sawhney, Manisha, et al. "Depressive Symptoms and Coping Strategies Among Indian University Students." *Psychological Reports*, vol. 123, no. 2, 2018, pp. 266–80. Crossref, doi:10.1177/0033294118820511.
- Tanaka, Chika, et al. "A Qualitative Study on the Stigma Experienced by People with Mental Health Problems and Epilepsy in the Philippines." *BMC Psychiatry*, vol. 18, no. 1, 2018. Crossref, doi:10.1186/s12888-018-1902-9.
- "What Is Depression?" *American Psychiatric Association*, 2020, www.psychiatry.org/patients-families/depression/what-is-depression. Accessed 9 Sept. 2020.



Bahala na! And Nine Other Ways to Be Toxic: A Graphically Illustrated Zine Depicting Toxic Filipino Mentality

Mikiyo Chloe D. Ricamora
De La Salle University Integrated School, Manila

Abstract: *Bahala na! and Nine Other Ways to Be Toxic* is a digitally illustrated zine that aims to represent the toxic Filipino mentality in a satirical but humorous and refreshingly honest manner. The work serves as a graphic representation of habits that individuals should avoid to become better Filipino. A focus group discussion was conducted with four DLSU students and a licensed psychologist to understand the topic further. The findings showed that these traits dominantly come from whom we interact with and adapt from others—such was used to take inspiration for the artwork. The work tackled several toxic traits, which are separated into illustrations. Also, Enriquez's Filipino Values Structure was used to guide the identification and relation of characteristics. Typography and graphic illustrations were used in the piece to express the subject. The medium, zine, was chosen as an alternate form for niche subjects and artists marginalized by mainstream media. This allows connection, community, and networking between those engaged in these diverse topics.

Key Words: Filipino; toxic traits; illustration; zine; graphic design

1. OVERVIEW OF THE ARTWORK

Along with technology development, more and more Filipinos are becoming aware of society's social problems. People develop a more critical and expansive attitude that makes them sensitive to relevant issues. However, toxic Philippine culture, several bad habits that people in the Philippines may have developed from their peers or families, is one of the topics discussed throughout this paper and art. This artwork aims to act as a tool for self-reflection and actualization. This subject was chosen because it is currently one of the least discussed topics.

The artwork presented these toxic characteristics in a satirical but humorous and refreshingly honest way. Satire uses humor, irony, exaggeration, or mockery to reveal and denounce people's foolishness or vice. In this way, the zine induces people to reflect on themselves without portraying specific characteristics in an intense or infuriating manner. This piece breaks from the usual upfront way of discussing social problems by directly depicting such bad traits.

The zine was chosen as a medium as they are a suitable outlet to voice new topics. Historically, zines are an alternate forum for niche subjects and artists marginalized by mainstream media. Zines are vital because they allow connection, community, and networking between those engaged in these diverse topics and bring out one's creativity and advocacy.

Moreover, the artwork presented the said toxicity in an infrequent approach and tone. Using the satirical approach introduces a refreshingly honest and humorous method of introducing toxic

traits. Satire is "the use of humor, irony, exaggeration, or ridicule to expose and criticize people's stupidity or vices." With such an approach, the piece may induce self-reflection for the viewers. Individuals will be able to assess whether they are guilty or not of possessing the said mentality. As stated by Turner from *American Arts Quarterly*, satire does what critical language is supposed to do. Satire enables comparison, insight, and understanding. Despite our interests and preconceptions, it attests to our ability to see our species and ourselves' flaws. Satire and art can be a tool for artists to be the passageway into the heart of humanity.

For a long time, Filipinos have been using satire as a political weapon to present their rants and raise their voices to revolt against the government's inconsistencies and detrimental flaws. The objective of this piece is not far from theirs. This piece acts as a mirror for Filipinos to possibly change their old ways for the better.

2. UNDERSTANDING THE ARTWORK

2.1 *The Filipino Values Structure*

Filipinos are emotionally driven individuals. Enriquez's chart from the book *Indigenous Psychology: A Book of Readings* explains the Filipino value structure in terms of surface, core, and societal.

As stated by Yacat, Enriquez coined the phrase "surface values" to refer to a group of readily apparent values, particularly for non-Filipinos, but



not typically the most significant ones (4). The accommodative surface values (*pakikisama*, *hiya*, and *utang na loob*) cause foreigners to presume that the Filipinos are other-oriented. Even so, non-Filipinos may still neglect to note that confrontational surface ideals (*bahala na*, *pakibaka*, and *lakas ng loob*) are equally important to Filipinos when circumstances call for individual rights to be claimed. In the over-emphasis on accommodative values and corresponding neglect on its counterpart, the confrontative, Enriquez called the *pasukong Pilipino* (the submissive Filipino) a distorted and incomplete view of the Filipino (Yacat 4).

Yacat also stated that *kagandahang-loob*, a connection between socio-personal meaning, predisposes individuals to respond to the broader collective society's needs and objectives. Consequently, an individual who values *kagandahang-loob* is also likely to value *karangalan*, *katarungan*, and *kalayan* (4).

2.2 Traits

As Filipinos are emotion-driven individuals, one may result in emotion-driven actions and their unconscious decisions. Relating the Filipino Values Structure to its corresponding toxic traits, one may result in toxic actions such as:

- A. Looking at Mental Illness as *Kaartehan* (Lack of *Pakikiramdam*)
- B. Bullying as a Form of Entertainment (Lack of *Pakikisama* and *Pakikiramdam*)
- C. Crab Mentality (*Sama*)
- D. Thinking Highly of Lighter Skinned People (Lack of *Karangalan*)
- E. Being Part of LGBT+ as an Insult (Lack of *Pakikisama* and *Kalayaan*)
- F. Romanticizing Resilience (Lack of *Pakikiramdam*)
- G. Ningas Kugon (Lack of *Pakikibaka*)
- H. Older People Belittle Younger People / Ageism (Kapwa)
- I. Manana Habit (Escaping to Achieve *Kalayaan*)
- J. Bahala Na Attitude (No determination)

2.3 Focus Group Discussion

A focus group discussion was held to generate baseline information and inspiration to extract respondents' perceptions of toxic Filipino traits, personal experiences, and effects. The method was chosen to discuss particular experiences and to gather opinions regarding the topic. Additionally, the discussion contributed information for the artwork's write-up.

The researcher personally selected the participants. The FGD included four students from DLSU and a licensed psychologist. It was essential to

select participants who had background knowledge and experiences regarding the topic. In the FGD, the participants were asked to share their opinions and interpretations regarding toxic Filipino traits.

All the participants have agreed that the traits are adapted from people surrounding them or through social influence. They also stated that although most Filipino's adapted these characteristics, it was their responsibility to realize their mistakes. They mentioned that an avenue to learn and widen our knowledge and perspectives on different topics was vital in discussing these topics. Moreover, they discussed that change must start individually and can be achieved through self-reflection.

3. THE ARTWORK

3.1 Overview of the Concept

Bahala na! And 9 Other Ways to Be Toxic is a digitized zine intended to explain the toxic Philippine culture in a satirical but relatable and refreshingly honest manner. It acts as a graphic representation of things that we should avoid to be better Filipino. Type and graphic illustrations are used to express real-life dialogues and scenarios.

3.2 Details of the Art Concept

The artwork's style is more modern and displays bright colors, focusing on the artist's style. It concentrates on a modern Philippine theme, as the subject reflects.

The medium selected for the artwork is a zine. A zine is a self-published, non-commercial print-work that is generally created in small, limited quantities. Zines have a wide range of subjects, from music and art to politics, sexuality, satire, and personal memoirs. Its content may be written, illustrated, printed, collaged, or any other type of combination of words and images—a zine may be narrative, journalistic, comic-like, or wholly abstract. Zines serve as an outlet for commonly unvoiced topics, which suits the subject very well.

Bahala na! and Nine Other Ways to Be Toxic introduces itself with a satirical and humorous approach. It displays the said traits in a cheeky way that isn't afraid to make fun of its subject. The method is to treat characteristics as a form of comedy and ridicule of toxic individuals. In this way, people will be able to connect to them by showing real situations. The artwork is not intended to invalidate the victims and empower the antagonists but to make fun of the antagonists. Although a bold approach, this method can be helpful both in presenting information and captivating audiences. In fact, for a long time, satire has been used in art, design, and literature as a means



of telling the truth to power, of robbing people's consciences (Miller, Aiga Eye on Design).

3.3 Visual Studies

Generally, the artwork is inspired by art pieces from several artists. The vibrant colors bring personality and interest to the work. Its appeal magnifies the context of the zine and superimposes the relevance of its theme.

3.4 Colors and Symbols

The chosen color palette consisted of various vibrant colors; thus, it was important that it looked lively and would draw attention. Striking and visual characteristics are considered more appealing, with vivid colors and high contrast (Valkenburg 49). The use of the familiar Filipino elements was equally vital as it establishes the theme's visual identity.

3.5 Art Style

A consistent Flat Design illustration style was used. According to Tubic Studio, Flat Design is where digital art has found its broad and diverse expression and is famed for the minimalist and concise visual expressive methods. Today, because harmonic simplicity is based on this design approach, the term is widely used as the opposites to "rich design." The most prominent feature that inspired this direction's name is that flat two-dimensional visual information contrasts highly realistic and detailed skeuomorphic images.

4. ACKNOWLEDGMENTS

To my friends, family, and teachers, my heart is smiling for your undying support. I could not have done this without all of you.

To all the toxic Filipinos, thank you for giving me a research topic.

5. REFERENCES

Literary Terms. "Satire: Definition and Examples." Literary Terms, 15 Sept. 2017, literaryterms.net/satire/.

Miller, Meg. "Is Satire Possible in Art and Design Today?" Eye on Design, 16 July 2019, eyeondesign.aiga.org/whats-the-state-of-satire-in-graphic-design/.

Turner, Frederick. "On Satire in the Arts." Newington-Cropsey Cultural Studies Center, www.nccsc.net/essays/satire-arts.

Studio, Tubik. "How to Create Original Flat Illustrations: Tips from Graphic Designer." Medium, Medium, 29 Mar. 2018, medium.com/@tubikstudio/how-to-create-original-flat-illustrations-tips-from-graphic-designer-e52e8ebee700.

The Bindery. "What Is a Zine?" The Bindery, www.binderymke.com/what-is-a-zine.

Valkenburg, Patti, and Jessica Piotrowski. "Plugged In: How Media Attract and Affect Youth." Yale University Press,

Yale University, 2017, yalebooks.yale.edu/sites/default/files/files/Media/9780300228090_UPDF.pdf.

Yacat, Jay. "Filipino Psychology (Sikolohiyang Pilipino)." Encyclopedia of Cross-Cultural Psychology, pp. 551-556, www.academia.edu/6013406/Filipino_Psychology.



Pabalot: Digitally Illustrated Stickers on Social Media and Its Influences on Colorism in the Philippines

Chloe Ashley G. Tan

De La Salle University Integrated School, Manila

Abstract: Humanity continues to advance towards the unprecedented future. However, despite our various achievements as a collective, one of this generation's oversights is the blind eye to colorism in the media. This research paper aims to delve into the implications of this cultural prejudice and understand what influences colorism in contemporary Filipino society. Moreover, the paper intends to tackle these queries by discussing colorism and its influence on social media in modern Filipino society through the postcolonial lens. With this, I chose to normalize darker skin tone through *Pabalot*, a series of sticker packets aiming to eliminate the stigma against Filipinos with a darker complexion and spread awareness of the negative influences of social media on colorism in society and the youth.

Key Words: postcolonialism; colorism; stickers

1. OVERVIEW OF THE ARTWORK

The main focus of *Pabalot* is the skin—and how the color of the skin affects the way people perceive one another. The project contains around twenty-five stickers with five themes. It shows a series of Filipinos who are confident in their skin and tackles the broader issue of colorism in social media. *Pabalot* hopes to empower and motivate those affected by society's unreachable beauty standards and subvert the bias against darker complexions. Moreover, *Pabalot* hopes to normalize those with a darker skin tone throughout media and culture.

2. UNDERSTANDING THE ARTWORK

2.1 Postcolonialism as a Framework

Academic scholars and historical researchers have tackled colorism and attempted to elucidate its origins and relevance in modern society accurately. A fair amount of research papers and journal articles have been written on the topic, but many have yet to understand its lasting impact on mainstream media.

Colorism dates back to the post-colonial period. As the name suggests, post-colonialism is the historical period succeeding the aftermath of Western colonialism (Encyclopedia Britannica). The study of postcolonialism examines and analyzes the changes in culture, religion, and economy in countries that have undergone colonization and have been subjected to various forms of imperialism (Nair 1). The study highlights the impact of colonial and imperial rule and provides an insight into how Western bodies of knowledge and ideals marginalize the non-Western world. A study by Ronald E. Hall on skin color as a postcolonial hierarchy gives a more critical insight

into the dynamics of global coexistence. It explains the power imbalance between those with light and dark skin. The study discusses how the bias against those with darker skin is a direct result of the political objectives of individuals who were in power during colonial times (Hall 1). For instance, when Britain conquered Africa in the early 1700s, mass trading of African slaves occurred (Matin 4; Bertocchi 1). The slave trade created a divide between owner and slave in status and race, and its legacy persists in the world's economy, ideals, and functions today.

Being one of the most colonized regions globally, Southeast Asia remains conspicuously removed in postcolonial studies. Many have speculated that the lack of research and investigations is because Southeast Asian scholars are preoccupied with more urgent concerns and conflicts in their respective countries (Huat 1).

2.2 Colorism in Contemporary Filipino Society

Colorism has played a significant role in the history and development of the Philippines. Moreover, colorism runs rampant in modern-day society, whether showcased through the distribution of colorist ideals or deeply integrated within our culture.

A study conducted by Joanne Rondilla tackles how the notion of beauty and its relationship to skin color is rooted deep in one's everyday life (Rondilla 2). The abundant praise Filipinos give light skin can be dated back to the Spanish colonial period. Those with white skin were seen as powerful and held a higher social status; therefore, cultivating the belief that lighter skin was more desirable and had a much higher position in society (Limos 1). The bias toward a whiter complexion was further cemented when the



United States colonized the Philippines (Rondilla 2; Singson 2). For centuries, achieving light skin was the standard and remained to be the standard at present.

Colorism is apparent in contemporary Filipino society due to its prevalent presence in the media, mainly through the distribution of skin whitening advertisements throughout different media platforms. The skin whitening industry capitalizes on colorism and benefits from the distribution of this belief (Singson 7). Many have bought their way into the hands of these corporations through the assumption that skin whitening products can help those within the lower-income bracket improve their current situation. In hopes of improving their economic and social status, those of lower socioeconomic status seek out whitening and bleaching agents to achieve a certain level of aesthetic appeal (Singson 3).

2.3 Social Media in the Spread of Colorism

Social media and the rapid spread of information go hand in hand, which is why many brands and companies choose to advertise their products through various internet platforms (Agbaimoni 4 and 11). Though what seems to be a beneficial marketing strategy at first glance, social media advertising may occasionally have drawbacks on those consuming specific types of products. An example of such is skincare, or skin whitening, advertisements that, more often than not, push colorist ideals onto its consumers (Ramirez 1; Parameswaran 1). These advertisements are scattered across different online platforms.

One study delves into the consumer buying behavior on social media advertisements and concludes that several factors such as the consumers' opinions towards the authenticity and the visual appeal affect the probability of a product being sold (Harun, et al 4-6). Further, they discussed that the appeal of skin whitening advertisements comes from the believability of the companies marketing these products.

The broad reach of social media advertisements paired with its general appeal to its audience further perpetuates colorism and benefits the companies profiting from this socio-cultural bias.

2.4 Other Methodologies

Data was collected through a survey and numerous semi-structured interviews. The Google forms survey was distributed among the target audience in hopes of garnering around 20 respondents. The data collected was later used to strengthen the claims further and provide insights on the final output.

The semi-structured interviews were conducted over Zoom. I asked questions and engaged in discussions with the respondents. These interviews helped provide me with a deeper understanding of the topic, particularly the impact of colorism in daily life.

3. THE ARTWORK

The themes found in *Pabalot* are racial inequality, whitewashing, skin bleaching and whitening, empowerment, and confidence or love for one's skin. These themes are then translated into sticker packets. Each sticker shows scenarios or situations according to their corresponding theme.

Crooked. This ties into the crooked nature of racial inequality as a direct effect of colorism. The stickers under this theme depict scenarios relating to the Black Lives Matter movement.

Whiteout. This theme is inspired by the white correction fluid used for covering typing or writing mistakes and tackles the subject of whitewashing—another effect of colorism. Stickers under this pack tackle the whitewashing found in both commercials and social media, the negative impact of whitewashing on the youth's mental health, and how it shapes the beauty standard present in society.

Refine. Also known as the process of removing impurities from chemicals and metals, this theme is about skin bleaching and whitening. These stickers aim to spread awareness of the adverse effects and results of skin bleaching and whitening and show its impact on the youth.

Empower. This aims to empower those affected by the different forms of colorism by illustrating thematic photoshoots, mini-posters, social media posts, and empowering quotes.

Fidere. The Latin word for confidence, *Fidere*, relates to confidence and love for one's skin. The stickers depict this through images of people lounging under the sun and confident in their skin and confidence-boosting words and quotes.

4. ACKNOWLEDGMENTS

I would like to express my special thanks and gratitude to my research adviser, Ms. Jerilou Marie A. Buted, for guiding me throughout this paper's construction and for the patience, feedback, encouragement, and knowledge she has bestowed upon me.

I'd also like to thank my family and friends for their constant support amidst the development of my paper. Without their encouragement, I wouldn't have been able to find the motivation and strength to complete this paper.



5. REFERENCES

- Agbaimoni, Ola, and Lilach Bullock. "Social Media Marketing - Why Businesses Need to Use It and How." Marketing of Scientific and Research Organisations, June. 2013, ResearchGate, https://www.researchgate.net/publication/307649068_Social_Media_Marketing_-_why_businesses_need_to_use_it_and_how. Accessed November 5, 2020.
- Akram, Waseem. "A Study on Positive and Negative Effects of Social Media on Society." International Journal of Computer Sciences and Engineering, vol. 5, Mar. 2018, ResearchGate, https://www.researchgate.net/publication/323903323_A_Study_on_Positive_and_Negative_Effects_of_Social_Media_on_Society. Accessed October 27, 2020.
- Bertocchi, Graziella. "The Legacies of Slavery In and Out of Africa." IZA J Migration, 28 Dec. 2016. SpringerOpen, <https://izajodm.springeropen.com/articles/10.1186/s40176-016-0072-0#citeas>. Accessed 24 October, 2020.
- Dalziel, Alex. "Why is Southeast Asia Lacking in Postcolonial Perspectives?." The Jakarta Post, 30 Jan. 2019, www.thejakartapost.com/life/2019/01/30/why-is-southeast-asia-lacking-in-postcolonial-perspectives.html. Accessed 24 October, 2020.
- Dean, Brian. "Social Network Usage & Growth Statistics: How Many People use Social Media in 2020?." Backlinko, 12 Aug. 2020, <https://backlinko.com/social-media-users>. Accessed November 3, 2020.
- Hall, Ronald. "Skin Color as Post-Colonial Hierarchy: A Global Strategy for Conflict Resolution." The Journal of Psychology Interdisciplinary and Applied, vol.137, 1 Feb, 2003, pp. 41-53., doi: 10.1080/00223980309600598
- Harun, Mohd, Ida Mahsan, Mohd Zulkefli, and Muhammad Isa. "Skin Whitening Product: Factors That Influence and Stimulate The Consumer Buying Behavior on Social Media Advertisement." ResearchGate, Dec. 2016, https://www.researchgate.net/publication/313845967_SKIN_WHITENING_PRODUCT_FACTORS_THAT_INFLUENCE_AND_STIMULATE_THE_CONSUMER_BUYING_BEHAVIOR_ON_SOCIAL_MEDIA_ADVERTISEMENT. Accessed November 5, 2020.
- Huat, Chua. "Southeast Asia in Postcolonial Studies: An Introduction." Taylor & Francis Online, vol. 11, no. 3, 16 Sept. 2008, www.tandfonline.com/doi/abs/10.1080/13688790802226637. Accessed 24 October, 2020.
- Limos, Mario. "A History of Why Filipinos Are Obsessed with Skin Whitening." Esquire, 26 Apr. 2019, <https://www.esquiremag.ph/life/health-and-fitness/why-filipinos-obsess-over-skin-whitening-a00293-20190426>. Accessed 26 October, 2020.
- Martin, Phyllis. "Review: Britain, the Slave Trade and Its Abolition." Cambridge University Press, vol. 5, 1979, pp. 4-6. JSTOR, www.jstor.org/stable/532374. Accessed 11 October. 2020.
- Nair, Sheila. "Introducing Postcolonialism in International Relations Theory." E-International Relations, 5 Aug. 2018, <https://www.e-ir.info/2017/12/08/postcolonialism-in-international-relations-theory/>.
- Parameswaran, Radhika, and Kavitha Cardoza. "Melanin on the Margins: Advertising and the Cultural Politics of Fair/Light/White Beauty in India." Association for Education in Journalism and Mass Communication. 2009, SAGE journals, <https://citeseerx.ist.psu.edu/viewdoc/download?doi=10.1.1.1026.1977&rep=rep1&type=pdf>. Accessed November 5, 2020.
- "Postcolonialism." Encyclopedia Britannica, 26 Feb. 2018, <https://www.britannica.com/topic/postcolonialism>.
- Ramirez, Rachel. "Beauty Companies are Changing Skin-whitening Products. But the Damage of Colorism Runs Deeper" Vox, 1 Jul. 2020, <https://www.vox.com/first-person/2020/6/30/21308257/skin-lightening-colorism-whitening-bleaching>. Accessed November 5, 2020.
- Rivera, Kay. "Fair Play." Inquirer, 2018. <https://opinion.inquirer.net/120781/fair-play/amp>. Accessed 26 October, 2020.
- Rondilla, Joanne. "Colonial Faces: Beauty and Skin Color Hierarchy in the Philippine and the U.S." University of California, Berkeley, 2012. https://digitalassets.lib.berkeley.edu/etd/ucb/text/Rondilla_berkeley_0028E_12807.pdf. Accessed 26 October, 2020.
- Singson, Francine. "Colonialism's Role in the Success of the Filipino Skin Whitening Industry." Virginia Commonwealth University, Jul. 2017, VCU Scholar Compass, <https://scholarscompass.vcu.edu/cgi/viewcontent.cgi?article=1044&context=auctus>. Accessed 24 October, 2020.



COLMO: A Children’s Video Game Introducing the Concept of Emotions Through Visuals

Kate Patrice U. Ang, and Janellah Marvi S. Cadungon
De La Salle University Integrated School, Manila

Abstract: COLMO is a side-scrolling mobile video game for children ages six to eight years old that introduces the different emotions (happiness, sadness, anger, fear, and disgust) and consequently teaches the idea of empathy in the form of visual elements such as color. The study seeks to create a mobile video game that can effectively introduce emotions through visual narratives. This study is a side-scrolling mobile game inspired by games that have aesthetic visuals and a child-friendly plotline. Poststructuralism and deconstruction are the frameworks used to analyze the topic. Additionally, the researchers consulted studies relating to children, visual and gamified learning, and the emotions commonly associated with specific colors. Furthermore, the researchers interviewed an Early Childhood Education and Psychology specialist and a preschool teacher to gain a broader understanding of how we could introduce emotions effectively to COLMO’s target audience.

Key Words: children; colors; emotions; video game; visual learning

1. OVERVIEW OF THE ARTWORK

The mobile game revolves around the protagonist Colmo, a chameleon-like creature who had his heart divided into five separate jewels by a jealous fellow mage named Kalus. Colmo then ventured through the world of Chroma to get back the pieces of his heart. The jewels and the stages represent the five emotions: fear, sadness, joy, anger, and disgust. The player can control Colmo to make basic movements such as moving left and right and jumping.

The study aims to introduce to children the concept of emotions to identify and regulate them accordingly. The visual elements of video games could be used as an incentive medium for learning. Moreover, the goal is to depict the different emotions using visual aspects such as colors, environment design, and character design. At the same time, the game is suitable for children to absorb, recognize, and regulate their emotions efficiently.

Six- to eight-year-olds are encouraged to play this game and similar to it for them to achieve emotional understanding. That way, they may learn how to label what they are feeling and find ways to regulate it independently, which will be helpful as they grow older.

2. UNDERSTANDING THE ARTWORK

2.1. Review of Related Literature

The related literature consists of materials about children, colors, emotions, gamified learning, visual learning, character, environment. The findings show that children learn and adapt through curiosity,

experimentation, and imitation; the more straightforward, the better (*Raising Children Network*; Ware 440). Thus, children’s learning is further enhanced through visuals.

Children become self-aware of their emotions at the early age of four, and they exercise empathy starting at the age of five or six (Poole et al.). According to Pope et al., a child has emotional understanding when they can comprehend and explain their own emotions and that of others (1). Emotional understanding could lead to better attendance and school performance and increased motivation and confidence (7).

COLMO’s straightforward representations will make it easier for children to understand. Human emotions are intense feelings that a person gives to someone or something (Hume 260). It is usually combined with obvious expressions on a person’s face (261). Often, some emotions are too complicated to depict as it is difficult to recognize (262). Facial expressions are evident in communication since they express our emotions and interests (Ware 308). Emotions easily expressed in faces—happiness, surprise, sadness, fear, anger, and disgust—are the six basic universal emotions (Hume 262).

Happiness is the emotion we feel when we react to positive stimuli and pleasure as well as comfort and “unspecific overall pleasant well-being” (Zinck and Newen 17). At the same time, sadness describes the feeling of emotional distress (e.g., worry and discomfort) and influences unease and sadness (16). Anger is a negative emotion that begins with the expression of indistinct grief and an alarming reaction toward situations of impairment and frustration (17).



Akin to anger, fear is an unfocused expression of distress that exhibits strong perturbation; however, it comes with the sense of danger by any threat (15). On this note, surprise can be incorporated within the category of fear when the presence of an unknown threat is present. Last, disgust is the emotion that emerges from the idea of distaste and rejection and exhibits an aversive response from a person's cultural, personal, or moral beliefs (Plakias 263-264).

Designing a platform that maximizes motivation and engagement can enable the players to pay more attention to the screen they see (Kapp 12). The appeal that video games provide toward their players can enhance learning (Buckley and Doyle 1163). Further, research conducted by Cubans showed that eighty-three percent of what was learned came from what we see, while eleven percent came from what we hear (qtd. in Shabiralyani et al. 226). This shows that people can retain information more when represented visually.

2.2. Other Methodologies

We conducted semi-structured interviews with two individuals with educational and professional backgrounds in psychology and early childhood education. One is a licensed preschool teacher, and the other specializes in early childhood development.

According to our first interviewee, modeling, mirroring, and labeling effectively introduce emotions to children. These practices help them self-regulate their feelings which could affect their future if ignored. If they can see pieces of themselves as part of the story, their interest in the story would deepen. The interviewee advised us to keep the vocabulary and the story simple and easy to grasp. The recommended age for the target audience is three to five years old.

Our second interviewee advised us to label emotions to help children understand themselves and avoid future problems as they grow. Additionally, emotions cannot be controlled but can be managed or regulated. As such, our game must be easy to finish and age-appropriate, keeping in mind children's reading comprehension. The recommended age range is five to seven or six to eight years old.

3. THE ARTWORK

We applied the findings from both the related literature and other methodologies into our proposed mobile game COLMO. We created concept art and a user interface to showcase the game.

Creating certain assets of the game, such as character design renders and the environment backgrounds, was distributed between the two researchers. We had to consider different factors, such as the character's story, personality, shape, and colors. We also had to evaluate whether the backgrounds and

the characters would complement and if all the artworks were coherent. Additionally, since the game is for children, we had to take the game's accessibility and appeal to children in mind.

Color plays a substantial role in our method of getting across the complexity of emotions in our game. COLMO's design used related studies to create the appropriate color representation of each emotion to make correct associations. Gohar's work demonstrated the basic emotions' characteristics through colors. It concluded that "red was associated with anger, green with disgust, black with fear, yellow with happiness, blue with sadness, and bright with surprise" (qtd. in Sutton and Altarriba 686-687). Sutton and Altarriba's experiments gleaned similar results (692-728). Thus, we used the five emotions and their respective associations.

3.1. Character Design

The character designs are composed of basic shapes that fit the character's personality—circles for dynamism, innocence, youth, and energy; squares for maturity and stability; and triangles for aggression and force. Further, other features included the characters' colors and personalities.

3.2. Environment Design

COLMO's environments are designed based on the colors the emotion represents and whether there is harmony or dissonance between the character and the environment. A round character in a circular environment suggests harmony, while a round character and a sharp environment suggest dissonance.

3.3. User Interface Design

The user interface is designed to be appropriate for children—simple and easy to navigate. Moreover, instructions use simple vocabulary to accommodate their literacy capabilities.

4. ACKNOWLEDGMENTS

We dedicate this paper to our dearest friends and family, who have supported us in our ongoing journey as artists. We also dedicate this paper to the development of De La Salle University's young Arts and Design Track, to its tight-knit faculty who assisted in developing the artists' skills, and to the upcoming students who have found interest in pursuing the arts. This paper serves as a testament to our growth as Arts and Design students and serves as a future reference point for aspiring artists who decide to follow the same path we have tread.



5. REFERENCES

- Andrews, Marcus. "Game UI Discoveries: What Players Want." *Gamasutra*, 23 Feb. 2010, https://www.gamasutra.com/view/feature/132674/game_ui_discoveries_what_players_php.
- Barry, Peter. *Beginning Theory: An Introduction to Literary and Cultural Theory*. Manchester University Press, 2002.
- Bowers, Micah. "Level Up – A Guide to Game UI (with Infographic)." *Toptal Design Blog*, 17 Sept. 2019, www.toptal.com/designers/gui/game-ui#:~:text=A%20video%20game%20user%20interface,Diegetic%2C%20Meta%2C%20and%20Spatial.
- Browne, Kevin, and Christopher Anand. "An Empirical Evaluation of User Interfaces for a Mobile Video Game." *Entertainment Computing*, vol. 3, no. 1, 2012, pp. 1–10. Crossref, doi:10.1016/j.entcom.2011.06.001.
- Buckley, Patrick and Elaine Doyle. "Gamification and Student Motivation." *Taylor & Francis*, 8 Sept. 2014, www.tandfonline.com/doi/abs/10.1080/10494820.2014.964263.
- Cooper, Jonathan. "The 12 Principles of Animation in Video Games." *Gamasutra*, 13 May 2013, www.gamasutra.com/view/news/342457/The_12_principles_of_animation_in_video_games.php.
- Deterding, Sebastian, et al. "From Game Design Elements to Gamefulness." *Proceedings of the 15th International Academic MindTrek Conference on Envisioning Future Media Environments - MindTrek '11*, Sept. 2011, pp. 9–15, doi:10.1145/2181037.2181040.
- Dickey, Michele D. "Engaging by Design: How Engagement Strategies in Popular Computer and Video Games Can Inform Instructional Design." *Educational Technology Research and Development*, vol. 53, no. 2, 2005, pp. 67–83. Crossref, doi:10.1007/bf02504866.
- Dominguez, Adrian, et al. "Gamifying Learning Experiences: Practical Implications and Outcomes." *Redirecting*, ELSEVIER, 2012, doi.org/10.1016/j.compedu.2012.12.020.
- Elliot, Andrew J., and Markus A. Maier. "Color and Psychological Functioning." *Current Directions in Psychological Science*, vol. 16, no. 5, 2007, pp. 250–254. JSTOR, www.jstor.org/stable/20183210. Accessed 12 Oct. 2020.
- Evans, Cara L., et al. "Selective Copying of the Majority Suggests Children Are Broadly 'Optimal' Rather than 'over' Imitators." *Developmental Science*, vol. 21, no. 5, 2017, doi:10.1111/desc.12637.
- Habgood, M. P. Jacob, and Shaaron E. Ainsworth. "Motivating Children to Learn Effectively: Exploring the Value of Intrinsic Integration in Educational Games." *Journal of the Learning Sciences*, vol. 20, no. 2, 2011, pp. 169–206., doi:10.1080/10508406.2010.508029.
- Harcourt, Bernard E. "An Answer to the Question: 'What Is Poststructuralism?'" *SSRN Electronic Journal*, 2007, doi:10.2139/ssrn.970348.
- Hume, David. "Emotions and Moods." *Organizational Behavior*, 2012, pp. 258–297. <http://vig.prenhall.com/samplechapter/0132431564.pdf>. Accessed 26 Oct. 2020.
- Joosten, Evi, et al. "Colors and Emotions in Videogames." *CiteSeerX*, 2010, citeseerx.ist.psu.edu/viewdoc/download?doi=10.1.1.386.9798&rep=rep1&type=pdf.
- Kapp, Karl M. *The Gamification of Learning and Instruction: Game-Based Methods and Strategies for Training and Education*. Pfeiffer, 2012.
- Khalid, Tooba, and Syeda Hina Batool. "Learning through Video Games: A Case Study of Private Schools of Pakistan." 2018 International Conference on Information Management and Processing (ICIMP), 2018, doi:10.1109/icimp1.2018.8325855.
- "Learning: Primary and Secondary School Years." *Raising Children Network*, 24 June 2019, raisingchildren.net.au/school-age/school-learning/learning-ideas/learning-school-years.
- McGonigal, Jane. *Reality Is Broken: Why Games Make Us Better and How They Can Change the World*. Vintage, 2012.
- Minkinen, Toni. "Basics of Platform Games." *Theseus*, 2016, www.theseus.fi/bitstream/handle/10024/119612/Thesis%20-%20Toni%20Minkinen.pdf?sequence=1.
- Mitchell, Briar Lee. "Game Design Essentials." *Google Books*, Wiley, 2012, books.google.com.ph/books?hl=en.
- Palmer, Eric W. "Visual Learning Styles Among Digital Natives." *Purdue e-Pubs - Purdue University*, 2011, docs.lib.purdue.edu/cgi/viewcontent.cgi?article=1003&context=cgtheses.
- Plakias, Alexandra. "The Good and the Gross." *Ethical Theory and Moral Practice*, vol. 16, no. 2, 2013, pp. 261–278. JSTOR, www.jstor.org/stable/24478796. Accessed 26 Oct. 2020.
- Poole, Carla, et al. "Ages & Stages: Empathy." *Scholastic*, 13 Oct. 2020, www.scholastic.com/teachers/articles/teaching-content/ages-stages-empathy/.
- Pope, Debbie J., et al. "Emotional Understanding and Color-Emotion Associations in Children Aged 7-8 Years." *Child Development Research*, vol. 2012, 2012, pp. 1–9., doi:10.1155/2012/975670.
- Quiñones-Camacho, Laura E., and Elizabeth L. Davis. "Children's Awareness of the Context-Appropriate Nature of Emotion Regulation Strategies across Emotions." *Cognition and Emotion*, vol. 34, no. 5, 2019, pp. 977–985., doi:10.1080/02699931.2019.1687426.
- Rieffe, Carolien, and Mark De Rooij. "The Longitudinal Relationship between Emotion Awareness ..." *SpringerLink*, 2012, link.springer.com/content/pdf/10.1007%2Fs00787-012-0267-8.pdf.
- Shabiralyani, Ghulam, et al. "Impact of Visual Aids in Enhancing the Learning Process Case Research: District Dera Ghazi Khan." *Journal of Education and Practice*, vol. 6, no. 19, pp. 226–233, iiste.org/Journals/index.php/JEP/article/view/24185/0.
- Solarski, Chris. "The Aesthetics of Game Art and Game Design." *Gamasutra*, www.gamasutra.com/view/feature/185676/the_aesthetics_of_game_art_and_php. Accessed 19 Oct. 2020.
- Sutton, Tina M., and Jeanette Altarriba. "Color Associations to Emotion and Emotion-Laden Words: A Collection of Norms for Stimulus Construction and Selection." *Behavior Research Methods*, vol. 48, no. 2, 2015, pp. 686–728., doi:10.3758/s13428-015-0598-8.
- "The Basics of Character Design." *Skill Share, Skill Share Team*, 2020, www.skillsshare.com/projects/The-Basics-of-Character-Design/137943. Accessed 20 Oct. 2020



3RD DLSU SENIOR HIGH SCHOOL RESEARCH CONGRESS

DIGITAL ARTS

- Thurlin, Tomi, et al. "(PDF) Designing Functional and Visual Elements of Computer Game Models..." ResearchGate, 12 Mar. 2019, www.researchgate.net/publication/331683747_Designing_Functional_and_Visual_Elements_of_Computer_Game_Models-CASE_AirBuccaneers.
- Tong, Mark. "Side Scrollers: A Planar Odyssey." Stanford, 23 May 2001, web.stanford.edu/group/htgg/sts145papers/mtong_2001_2.pdf.
- Ware, Colin. Information Visualization: Perception for Design. Morgan Kaufmann, 2013.
- Zinck, Alexandra, and Albert Newen. "Classifying Emotion: A Developmental Account." Synthese, vol. 161, no. 1, 2008, pp. 1–25. JSTOR, www.jstor.org/stable/27653677. Accessed 26 Oct. 2020.



Forked: A Comic Book Depicting the Struggles of Pursuing One's Dream versus Parental Choices

Ricardo O. Moldez III

De La Salle University Integrated School, Manila

Abstract: My research paper is about the Asian stereotype of being forced into a specific profession over personal choice using the socio-cognitive framework. The said stereotype has always been frequently used in jest, though in reality, it is a challenge faced by the youth due to culture and their environment. My objectives are to spread awareness of the stereotype, its adverse effects, and the perspective of those who are affected by it. To structure and develop the plot of the output, I conducted a semi-structured interview with Senior High School students about their experiences with the stereotype. The work consists of one fully illustrated comic, consisting of a cover page and thirteen comics illustrations and dialogue.

Key Words: stereotype; Forked; comic book; culture; environment

1. OVERVIEW OF THE ARTWORK

The comic book titled *Forked* is inspired by my past experiences and aims to show how everyone deserves a chance to follow their dream. The title *Forked* is taken from the phrase “fork in the road,” which means a divide in paths—the divide, in this case, refers to the choice between one’s interests and the choice of one’s parents. The comic book is often associated with superheroes since the 1930s (Resha). I chose this medium to have both visual and text elements.

The book titled *Understanding Comics* by Scott McCloud discusses that comics aren’t some crude and cheap art form but elegant and straightforward. To define the art of comics, McCloud used the term “sequential art,” which is the definition of comics said by Will Eisner, a master comic artist. McCloud gives another description of comics as “juxtaposed pictorial and other images in deliberate sequence, intended to convey information and to produce an aesthetic response in the viewer (9)”.

2. UNDERSTANDING THE ARTWORK

When people grow up, they have to choose among many career paths. For Asians, there is a stereotype of parents selecting the professions of their children. According to this stereotype, Asian parents view specific jobs as “desirable” while others do not, as they understand that doing what one loves may not bring forth income or food on the table (Chiu).

Choosing for oneself or following another’s decision can be explained by *Individualism-Collectivism* (Akosah-Twumasi et al.). The idea notes that in individualistic cultures, people’s choices are based on their passions and interests. In contrast, in collectivist cultures, choices are made by an “in-group.” The options made are for the further

development of the group and its followers (2). In those stereotypes, the child could be associated with an individualistic culture as they may want to follow their beliefs. The family as a whole can be labeled with collectivistic culture, with the parents as the “in-group.”

Asian parents usually prioritize a career’s income, especially in the long term as it will support the family and their future. The stereotype is associated with the term “debt of gratitude” or in Filipino “utang na loob” (Rungduin et al.) as the parents expect the child to pay back that debt for following their parent’s choice of career.

I developed the artwork’s storyline with Senior High School students who were forced into a course that they did not want. Using a semi-structured interview, I gathered testimonies and experiences as references, and I composed the plot and dialogue for the comic book.

3. THE ARTWORK

The story is set in Manila and follows Ford, a Filipino student who is graduating and moving onto college. But he is faced with his biggest challenge yet, convincing his family to let him follow his dreams. Though it is easier said than done, in his country, following one’s dreams is only acceptable if said dream is to be a doctor, lawyer, or anything of that sort.

The comic book puts the viewer into the perspective of a student who wants to follow their dream. Said experiences and mindsets are referenced by the students I interviewed, with each having similar experiences to the other.

Each page went through a storyboard on paper; then, the panels were laid out using Adobe Photoshop. The illustrations were later sketched,



inked, and colored on Procreate. Lastly, the dialogue was added using Adobe Photoshop.

4. ACKNOWLEDGMENTS

To my parents, Ricardo Moldez II and Desiree Gertrude Orquila Moldez, thank you for supporting me as I go down this journey of mine. All of this wouldn't be possible without your support. To my brother Inigo Moldez, thank you for giving me a reason to continue this journey.

To my research and homeroom adviser, Ms. Jheng Buted, thank you for guiding and encouraging me through my journey.

To my friends, Ella, Justine, Geejay, Pixie, and Isa. Thank you for cheering me on and for staying by my side

And to me, thank you for staying.

5. REFERENCES

- Akosah-Twumasi, Peter, et al. "A Systematic Review of Factors That Influence Youths Career Choices—the Role of Culture." *Frontiers in Education*, vol. 3, 2018.
- Chiu, Amy Hsuan. "Asian Parents Stereotype against Art and Music as Career." *The Daily of the University of Washington*, 28 Feb. 2016, www.dailyuw.com/opinion/article_b47d2904de99-11e5-9eeb-4f9e4904920a.html.
- "Culture and Careers in Career Development" *IResearchNet*. 4 Dec. 2016, career.iresearchnet.com/career-development/culture-and-careers/.
- McCloud, Scott. *Understanding Comics*. HarperPerennial, 1994.
- Reshe, Adrienne. "The Medium of Comic Books." *The Blue Age of Comic Books*, scalar.usc.edu/works/blue-age-of-comic-books/index.
- Rungduin, Teresita Tabbada, et al. "The Filipino Character Strength of Utang Na Loob: Exploring Contextual Associations with Gratitude." *International Journal of Research Studies in Psychology*, vol. 5, no. 1, 2015, doi:10.5861/ijrsp.2015.1322.



Bahagharing Dagat: A Series of Graphic Illustrations Depicting Plastic Pollution Situation of Philippine Marine Life During the Pandemic

Justin Ferdinand B. Garcia
De La Salle University Integrated School, Manila

Abstract: The COVID-19 pandemic is on the rise, and so is the situation of plastic pollution in the Philippines. This qualitative study evaluated the degradation of the country's marine environments caused by plastic pollution during the pandemic. It explores the connection between marine biodiversity and people's livelihoods in the Philippines, the current effects of plastic waste on national waters, and the future implications of this pandemic on plastic pollution through a series of illustrations. The research used post-structuralism and ecocriticism as frameworks. A semi-structured interview was conducted to collect up-to-date data and personal experience to include in the creation. The collection consists of ten graphic design illustrations drawn in a low polygonal style with a polyptych layout.

Key Words: marine biodiversity; covid-19; post-structuralism; ecocriticism; graphic design

1. OVERVIEW OF THE ARTWORK

Bahagharing Dagat is a collection of illustrations that features a wide variety of aquatic life endemic in the Philippines. The main idea of the artworks is the destruction of the marine ecosystem because of the overuse of single-use plastics at the consumer and commercial levels. The collection aims to educate Filipinos on marine conservation for aquatic resources. The medium used is digital art, specifically graphic design. I used this medium for graphic design mainly for visual communication and emotional and cognitive information (Bichler and Beier). Viewers can reflect based on the information gathered from the artworks. With this, the collection can incite a change in the mindset about the conservation of the environment.

2. UNDERSTANDING THE ARTWORK

The research framework is based on post-structuralism and ecocriticism. Through a structuralist lens, the duality between humanity and nature and how nature is the "other" in this pair indicates an innate system that can be portrayed through text. In a post-structuralist perspective, this binary opposition has notions that can be contradictory based on the studies and data collected. With this, the text can be read as humanity and nature interconnected.

In studies, the Philippine seas have the highest level of marine biodiversity globally. However, in a data study conducted in 2015, the Philippines produces an annual plastic waste estimate of 1.88 million metric tons per year, with 0.28 - 0.75 million metric tons washed up as plastic marine debris. The impact of plastic debris on the marine environment is severe. Certain plastics also break down into

microscopic particles called "microplastics" that can be eaten by commercial fish and can cause toxic effects on animals and humans when ingested. According to the WHO, approximately 89 million medical masks were needed to respond to Covid-19 each month. This causes the daily global production of disposable masks to scale in output. If the masks are not disposed of properly, the degradation of these masks could lead to a new source of microplastics that could end up in waterways, polluting the aquatic habitat. With all this, we can apply a critical theory known as ecocriticism.

Ecocriticism is an "earth-centered approach" (Glotfelty, xviii), with the intersections between environment and culture, tracking environmental ideas and representations.

A semi-structured interview was also conducted with an employee who works on marine conservation organizations. I asked questions that were beneficial in establishing the up-to-date effects of plastic pollution in Philippine oceans. I also asked open-ended questions that could entail personal accounts and experiences on wildlife conservation that can be used in doing the artwork.

3. THE ARTWORK

The artwork consists of ten digital illustrations. It aims to portray the vastness and diversity of the Philippine waters through its elements, mainly color and composition. It also prioritizes visual storytelling using a polyptych design approach. The artwork features a mixture of low-polygonal design and lineless art. I chose this style since it evokes a feeling of comedy and an apocalyptic message. It is also inspired by triptych art, a work of art that has three sectional panels. Each illustration



has details that make it unique to showcase independently, but it completes a single narrative when joined. With this approach, I can achieve the visual storytelling aspect of the collection.

Color is one of the elements that I focus on the most in the illustrations. The polyptych design makes each design connected and illustrates the vastness of Philippine waters and its species.

4. ACKNOWLEDGMENTS

I would like to express my sincere gratitude to the people who made this artwork possible. Thank you to Miss Jerilou Marie A. Buted for the approval of this project and the supervision throughout the research and creation. Her guidance and enthusiasm have been an inspiration for me to push through with the research.

I would like to thank my family for providing the resources needed to finish the production and for giving support in these trying times.

I would also like to thank my ADT 12-B classmates for their constructive criticism and encouragement when reviewing my research.

5. REFERENCES

- Anticamara, Jonathan A., et al. "National Patterns of Philippine Reef Fish Diversity and Its Implications on the Current Municipal-Level Management." *Science Diliman*, vol. 27, no. 1, Jan. 2015, pp. 1–47. EBSCOhost, search.ebscohost.com/login.aspx?direct=true&db=a9h&AN=108692423&site=ehost-live
- Profile, Philippine Fisheries. "Bureau of Fisheries and Aquatic Resources." Department of Agriculture, Republic of the Philippines (2018): p. 9-13.
- Baztan, Juan, et al. MICRO 2016. Fate and Impact of Microplastics in Marine Ecosystems from the Coastline to the Open Sea. Elsevier Science, 2017.
- Bichler, Katrin Elisabeth, and Sofie Beier. "Graphic Design for the Real World? Visual Communication's Potential in Design Activism and Design for Social Change." *Artifact*, vol. 3, no. 4, 2016, p. 11., doi:10.14434/artifact.v3i4.12974.
- "Expedition to the 'Center of the Center' of Marine Biodiversity." California Academy of Sciences, www.calacademy.org/press/releases/expedition-to-the-center-of-the-center-of-marine-biodiversity.
- Carpenter, Kent & Springer, Victor. (2005). The center of the center of marine shore fish biodiversity: The Philippine Islands. *Environmental Biology of Fishes*. 72. 467-480. 10.1007/s10641-004-3154-4.
- Fadare, Oluniyi O, and Elvis D Okoffo. "Covid-19 face masks: A potential source of microplastic fibers in the environment." *The Science of the total environment* vol. 737 (2020): 140279. doi:10.1016/j.scitotenv.2020.140279
- Garrard, Greg. "Apocalypse." *Ecocriticism*, by Greg Garrard, Routledge, 2012, pp. 85–88.
- Glotfelty, Cheryll, and Harold Fromm. *The Ecocriticism Reader: Landmarks in Literary Ecology*. University of Georgia Press, 2009.
- Institute for Global Environmental Strategies. Implications of COVID-19 for the Environment and Sustainability. Institute for Global Environmental Strategies, 2020, www.jstor.org/stable/resrep24951. Accessed 13 Aug. 2020.
- Jacobson, Susan K., et al. "Integrated Science and Art Education for Creative Climate Change Communication." *Ecology and Society*, vol. 21, no. 3, 2016. JSTOR, www.jstor.org/stable/26269971. Accessed 13 Aug. 2020.
- Jambeck, J. R., et al. "Plastic Waste Inputs from Land into the Ocean." *Science*, vol. 347, no. 6223, 2015, pp. 768–771., doi:10.1126/science.1260352.
- Lowe, Judi, et al. "Linking Livelihoods to Improved Biodiversity Conservation through Sustainable Integrated Coastal Management and Community Based Dive Tourism :Oslob Whale Sharks." *Marine Policy*, vol. 108, 2019, doi:10.1016/j.marpol.2019.103630.
- Michiel Roscam Abbing. *Plastic Soup: An Atlas of Ocean Pollution*. Island Press, 2019. EBSCOhost, search.ebscohost.com/login.aspx?direct=true&db=nlebk&AN=2383279&site=ehost-live.
- "Plastics Exposed: How Waste Assessments and Brand Audits Are Helping Philippine Cities Fight Plastic Pollution." www.no-burn.org/wp-content/uploads/PlasticsExposed-3.pdf. Global Alliance for Incinerator Alternatives, 2015.
- Vila, Alexandra Caole. "Why Covid-19 Is Asian Environmental Catastrophe in the Making." *South China Morning Post*, 9 Sept. 2020, www.scmp.com/lifestyle/health-wellness/article/3100495/covid-19-ecological-disaster-asia-single-use-plastics.



Kalalaki Mong Tao: A Series of Digital Illustrations Focused on Fragile Masculinity in the Philippine Context

Vincent Ryan O. Yap

De La Salle University Integrated School, Manila

Abstract: Gender roles have been exercised in the Philippines for as long as the country was colonized by the West. In such a predominantly patriarchal society, masculinity is favored and dominates over those who identify as feminine or other. This research looks into the structure and effects of fragile masculinity in people. The study of the Filipino masculine gender identity sheds light on why and how the notion of fragile masculinity came to be. Alongside several structured and semi-structured interviews, structuralism and Judith Butler's theory of gender performativity are used to gain a better understanding of the nature of hypermasculinity. The artwork series uses these theories along with other data gathering methods to address the underlying issues of fragile masculinity in Filipino society.

Key Words: fragile masculinity; gender roles; gender performativity; patriarchy; identity

1. OVERVIEW OF THE ARTWORK

For a long time, gender roles have served as a model for preserving a hierarchical culture. This, however, prevents people from discovering their identities outside of their assigned gender. How would a culture work if gender roles were not enforced as strictly as they are now? This study sought to address the following points to better understand the function of gender roles, their meaning, and their consequences:

- Filipino society's dependence on gender roles
- the impact of fragile masculinity on a Filipino life
- the differences in the gender expectation for Filipinos

The artist created a series of ten artworks that portray the consequences of fragile masculinity in Filipino society. Each piece depicts a scenario in which the protagonist either experiences an incident in which they defy gender norms or expresses their feelings regarding the gender roles forced on them. The artwork's narrative is focused on the study's participants to provide a more in-depth understanding of the effects of fragile masculinity and to discuss the respondents' personal experiences with the topic.

All of the artworks in a scene format are painted in a semi-realistic style. To unite the artworks, variations of the blue hue were used in each artwork.

2. UNDERSTANDING THE ARTWORK

2.1 The Roots of Patriarchy

To explore the context of the artworks, the understanding of patriarchy, structuralism, gender performativity, and social constructionism is essential. To elaborate, patriarchy is the systematic superiority of men over women in society. A patriarchal ruling system has been long existing in different communities throughout history (Farrelly 2). A brief study of the various ancient European civilizations can be observed to further examine patriarchy's position in society. Sparta was a city in Ancient Greece noted for its love of the arts, literature, and wisdom—but excluded women from this narrative as they were deemed to lose their rationality.

2.2 Gender Performativity and Social Constructionism

Delving into Judith Butler's works on gender performativity and social constructionism, Blechner described masculinity as the "confluence of factors." The query "What is a real man?" keeps him intrigued. He goes on to discuss the various prejudices that are forced on men in his culture (e.g., independence, rough-and-tumble play, heightened libido). These stereotypes are the generalized and oversimplified understanding of gender roles by a society (Blackstone 337). Moreover, gender is performative, as stated by Judith Butler, and there is little to no stability of gender (Butler 53). Someone can appear as a particular gender; however, gender is not fixed. Butler uses Simone de Beauvoir's assertion in *The Second Sex*, "One is not born, but rather becomes a woman," to expand on her argument that the gender "woman"



is the conforming of one person to what has traditionally been regarded and generally accepted as a woman.

2.3 On Heteronormativity

In terms of appearance or behavior, effeminate men or masculine women are perceived as "improper." In a video by The Media Insider describing Butler's Gender Trouble, this "proper" act and appearance are the product of what Judith Butler refers to as heteronormativity (The Media Insider, 03:35–03:43). Heteronormativity is the root of gender trouble, as it reinforces the stereotypes of men and women. On the lack of queer representation in mass media, they assert, "People who don't fit the mold have difficulty and pain performing their non-heterosexual identity" (The Media Insider, 05:01-05:07).

2.4 Social Constructionism

Social constructionism is a philosophy that argues that social forces and contact between people are responsible for the current state of human life (Galbin 82). People live among ideas created by humans, according to social constructionists. The 333-year Spanish colonization and the 47-year American occupation of the Philippines have dominated our current understanding of gender identity, according to Marie Lou Frias Bautista. The social stratification started with the arrival of the Spaniards. Men and women were ranked differently in the education system developed by these colonizers.

Apart from these historical influences, gender roles and norms are perpetuated in Philippine education, passively and actively. In an online article by Java and Parcon, textbooks targeted at first-graders included a large number of images portraying "occupational and social picture roles of men and women" (Java et al. 38).

2.5 Other Methodologies

A focus group discussion was conducted together with interviews (semi-structured and structured) to provide more context as well as specificity and depth to produce the artworks. The focus group discussion was about Filipino gender roles and the participants' perceptions and experiences with them. The participants asserted the feeling of being restricted and boxed in stereotypes, confusing one's identity. Interviews of semi-structured and structured types were also conducted to analyze ordinary citizens' narratives relating to the study's subject. A semi-structured interview would use a protocol to direct the artist and the interviewee while also allowing the interviewees some versatility (e.g., providing additional details). The structured interview contained similar questions to the semi-

structured interview but prevented the artist from gathering more personal information regarding the study from the participant's perspective.

3. THE ARTWORK

3.1 Process of the Artwork

Kalalaki Mong Tao is a series that showcases ten digital artworks about fragile masculinity in the Philippine context. To accomplish the art series, inspiration and narratives for the individual artworks were drawn from the data gathering methods. The use of the data from the participants of the study enabled the artist to humanize these narratives and further understand the causes and effects of assigning gender stereotypes. Before beginning the artwork production, the data gathered was thoroughly discussed and broken down into smaller concepts by the artist and his mentor to understand the data collected better.

3.2 Art Style

Proceeding to the production phase, the sketches were planned out and rendered in a realistic and painterly manner. Realism was the style chosen as the art movement initially depicted the unfavorable realities that people faced in various social, cultural, and political contexts. This origin provided the artist with a justification for making realistic artworks: to depict the ugly realities of fragile masculinity. Surrealistic elements can be seen in the artworks in small doses to provide more freedom of thought to the viewer.

3.3 Medium of the Artwork

Digital art has become more available to a growing number of people as a result of advancements in technology. People, especially the youth, are constantly exposed to digital media, allowing them to participate in various modes of communication and learning. As a result, the digital illustration tool is efficient and useful in presenting a variety of topics to both viewers and listeners.

Further, rather than relying solely on text, the use of visual aids is more effective in ensuring that people understand what is being addressed. Not everyone is capable of comprehending the speaker's speech, nor is everyone capable of comprehending every single word used in the lecture. The inability to understand the speaker's message or language causes disengagement with the lecture, according to a study conducted by Vadsariya in 2017. (Vadsariya 26) Students who were given a visual medium as a complement frequently regarded the visuals as the central theme of the discussion rather than just a supplement to the learning content. (27) This study proves that learning through the use of visual aids



enables people to connect their own experiences and retain knowledge and images in their minds rather than relying solely on text and voice to convey a message.

4. ACKNOWLEDGMENTS

Fulfilling this study would have been impossible from the start without my adviser and mentor, Ms. Jerilou Buted, who guided me throughout the entire process of creating this project. Without her, I would not have been able to accomplish this research paper. Thank you for the never-ending encouragement and reassurance you have given me not only as your advisee but as a student artist.

Following my mentor would be Sir Christian Cristobal, my multimedia arts teacher and former adviser. Thank you for always making sure that your students are doing the best that they can, even when we are not your advisees anymore. I will always be grateful for the guidance and motivation you have given me.

Without the continuous inspiration from the Arts & Design faculty and students of De La Salle University Integrated School, not only would I not have been able to fulfill this research, but I would not be as passionate about the things I do. I will always be grateful to the ADT Unit for the knowledge and determination they have invoked within me. Thank you for being the community that allowed us to grow and be ourselves.

To my parents, Michael and Clarita Olga Yap, thank you for giving me a chance to study at De La Salle University. I would not have become the person that I am today if it were not for the opportunities and support you have given me.

5. REFERENCES

Agura, Dianne. Non-gender Specific Toys. Facebook, 13 Oct. 2020, 2:59 p.m., <https://www.facebook.com/diannekiddo/posts/4268053496544883>. Accessed 23 Oct. 2020.

Bautista, Marie Lou Frias. "Historical Influences on Gender Preference in the Philippines." *Journal of Comparative Family Studies*, vol. 19, no. 1, 1988, pp. 143–153. JSTOR, www.jstor.org/stable/41601414. Accessed 18 Oct. 2020.

Big Think. "Judith Butler: Your Behavior Creates Your Gender | Big Think." YouTube, uploaded by Big Think, 6 June 2011, www.youtube.com/watch?v=Bo7o2LYATDc&t=28s.

Blackstone, Amy. "Gender Roles and Society." *Human Ecology: An Encyclopedia of Children, Families, Communities, and Environments*, 2003, pp. 335–38, www.researchgate.net/publication/304125569_Gender_Roles_and_Society.

Blechner, Mark J. "Maleness and Masculinity." *Contemporary Psychoanalysis*, vol. 34, no. 4, 1998, pp. 597–613., doi:10.1080/00107530.1998.10747024.

Bodenhausen, Galen V., et al. "Stereotypes and Stereotyping." *Encyclopedia of Social Psychology*. Eds. Roy F. Baumeister and Kathleen D. Vohs. Vol. 1. Thousand Oaks: SAGE Publications, Inc., 2007. 940–943. SAGE Knowledge. Web. 18 Oct. 2020, doi:10.4135/9781412956253.n557.

Britannica. "Colour - The Psychology of Colour." *Encyclopedia Britannica*, 1999, www.britannica.com/science/color/The-psychology-of-colour.

Butler, Judith. *Gender Trouble: Feminism and the Subversion of Identity* (Routledge Classics). 1st ed., Routledge, 2006.

Cislaghi, Beniamino, and Lori Heise. "Gender Norms and Social Norms: Differences, Similarities and Why They Matter in Prevention Science." *Sociology of Health & Illness*, vol. 42, no. 2, 2019, pp. 407–22. Crossref, doi:10.1111/1467-9566.13008.

Farrelly, Colin. "Patriarchy and Historical Materialism." *Academia*, 2011, www.academia.edu/10459389/Patriarchy_and_Historical_Materialism.

Galbin, Alexandra. "An Introduction to Social Constructionism." *Social Research Reports*, 2014, pp. 82–92, www.researchreports.ro/an-introduction-to-social-constructionism.

Hidalgo, Danielle Antoinette, and Kristen Barber. "Queer | Definition & Uses." *Encyclopedia Britannica*, 2016, www.britannica.com/topic/queer-sexual-politics.

Java, John Rey B., and Cristabel Rose F. Parcon. "Gendered Illustrations in Philippine Textbooks." *Asia Pacific Higher Education Research Journal*, vol. 3, no. 1, 28 July 2016, pp. 34–51., po.pnuresearchportal.org/ejournal/index.php/apherj/article/view/204.

Lee, Romeo B. "Filipino Men's Familial Roles and Domestic Violence: Implications and Strategies for Community-Based Intervention." *Health and Social Care in the Community*, vol. 12, no. 5, 2004, pp. 422–29. Crossref, doi:10.1111/j.1365-2524.2004.00512.x.

Martínez, Tomás Sola, et al. "Historical Review of Women's Role in Patriarchal Model Society of the Spanish Context." *The International Journal of Interdisciplinary Social Sciences: Annual Review*, vol. 3, no. 5, 2008, pp. 201–210., doi:10.18848/1833-1882/cgp/v03i05/52609.

Medina, Noemi A. "The Culture of Patriarchy and Its Effects on the Human Rights of Girl-Children in Cagayan De Oro and Claveria, Misamis Oriental: Implications to Policy Formulation." ser. 2015-44, 2015. 2015-44, dirp3.pids.gov.ph/webportal/CDN/PUBLICATIONS/pid_sdp1544_rev.pdf. Accessed 26 Aug. 2020.

Peppler, Kylie A. "Media Arts: Arts Education for a Digital Age." *Teachers College Record*, vol. 112, no. 8, 2010, pp. 2118–2153., www.researchgate.net/publication/262142960_Media_Arts_Arts_Education_for_a_Digital_Age.

Reverso, Zandrick. *Gender Stereotypes in DepEd Modules*. Facebook, 16 Oct. 2020, 5:55 p.m., <https://www.facebook.com/rzzzrk/posts/400491837619685>. Accessed 23 Oct. 2020.

The Media Insider. "Judith Butler's Gender Trouble Feminist Media Studies Theory Explained!" YouTube, uploaded by The Media Insider, 2 Dec. 2019, www.youtube.com/watch?v=ItPc2kPaxb0&t=51s.



3RD DLSU SENIOR HIGH SCHOOL RESEARCH CONGRESS

2023

DIGITAL ARTS

Vadsariya, Rozina. "VISUAL MEDIA AS A PEDAGOGICAL TOOL IN ENHANCING STUDENT ENGAGEMENT IN THE RE CONTEXT OF KARACHI." Journal of Teaching and Education, vol. 07, no. 01, 2017, pp. 9–30, www.researchgate.net/publication/322291842_VISUAL_MEDIA_AS_A_PEDAGOGICAL_TOOL_IN_ENHANCING_STUDENT_ENGAGEMENT_IN_THE_RE_CONTEXT_OF_KARACHI.



This is Home: A Digital Animation Telling A Story of A Filipino Immigrant Child Returning Home

Shafeiya Wynn S. Saldaña
De La Salle University Integrated School, Manila

Abstract: This study delved into the effects of return migration on children, their experiences, and struggles. Since return migration is not widely documented, it is imperative to raise awareness about this issue. The study aimed to understand (1) the experiences migrant children face, which are mainly marginalization, acculturation, and cultural dissonance, (2) how migration affects the formation of self-identity for migrant children, and (3) how we can alleviate the struggles of these migrant children. A focus group discussion was conducted among four formerly child migrants to represent the two-dimensional (2D) animation themes. This research delved into themes of postcolonialism, as it is one of the factors that constitutes return migration. This is Home is a two-dimensionally animated short film that showcases the experience of a twelve-year-old Filipina as she struggles to find herself in the Philippines after living in China for most of her life. This film tackled themes of loss, growth, separation, and sacrifice.

Key Words: return migration; postcolonialism; self-identity; child migrant; acculturation

1. OVERVIEW OF THE ARTWORK

The focus of this research paper is on migrant children experiencing return migration. This paper tackled the experiences, struggles, and intervention plans to help understand these situations better.

The paper emphasizes the struggles of these migrant children, mainly marginalization, acculturation, and cultural dissonance. These significantly affect the child's development of self-identity into adulthood being a result of postcolonialism.

As a child migrant, I encountered many issues, especially those relating to my identity, after growing up in China and mostly spending my childhood and early teenage years there while being Filipino by blood. It was difficult to grasp whether I was considered Chinese or Filipino more. These questions plagued my mind, especially during my time acculturating to my "motherland." It was hard to pinpoint which country I indeed call "home."

I chose the medium of animation to illustrate a sense of being "out-of-place" (cultural dissonance) and marginalized and the coming of age journey of developing self-identity and acculturation. I felt responsible for raising awareness about this under-researched topic.

2. UNDERSTANDING THE ARTWORK

The study is mainly focused on the experiences of child migrants when faced with return migration. Return migration, in this context, can be described as the movement of the children, migrating

to their parents' homeland. Different circumstances can bring about this movement, but more commonly due to the child's behavior, parents' work, or overall family decision (Lee 2). With the already under-researched topic of return migration, most documented cases observe adults rather than children and adolescents (Lee 2).

As for the struggles these migrant children face, many pointed out the difficulty put upon the children. Marginalization, acculturation, and cultural dissonance are concepts that are interconnected. When views or values of the country of origin and the host country are conflicting, not only do they experience marginalization, but they may experience cultural dissonance. These adolescents may acculturate or adapt to the host country's cultural values or beliefs, so it is highly encouraged for the parents to promote their homeland country's culture to their children (Pottie, et al. 1563). Excluding the children in the discussion of migration can also lead to adverse effects, as they would feel like they were "forced" to be here.

In a study titled, *Returning Home: An Evaluation of Hungarian Return Migration*, Lados, et al. found that the shift of return migrants' identities is integral in the move. On the topic of self-identity about return migration, Sussman's Cultural Identity Model identified the different types of identity shifters within their homeland and host country. The four types include affirmative, additive, subtractive, and global (322-323). The model emphasizes the changes these migrants go through and how this struggle affects their decision to leave their homeland. And it



would be helpful for them if they were provided with more aid, such as additional information (329).

Intervention plans were also provided, which can be performed within the family or the classroom. The migrant children's sense of agency in the move significantly shapes their acculturating experience in their new environment. It is encouraged that the family includes the child in the discussion or decision making regarding the move, as evidence showed they have a smoother transition into the host country and generally display more acceptance in the move (Lee 14). Maternal warmth played a big role in the acculturation of migrant children, mainly in their socioemotional development and school adjustment. Adapting strong parental warmth in these situations provides emotional and social support for the children. This is important, as it encourages the children to seek parental assistance and open up to them about their issues. This helps build more security and safety in their new environment (Zhao, et al. 542).

I conducted a focus group discussion (FDG) among four former child migrants who experienced return migration. All of them specifically returned to the Philippines after living in Shenzhen, China. Insights from the participants indicated the presence of marginalization, acculturation, and cultural dissonance. The struggle for self-identity was a running theme in the discussion between the group, wherein they found difficulty resonating with the Philippines. Although some of the participants didn't stay in China as long as the others, most still vocalized the confusion of "picking" or "identifying" their nationality. To which, half of the participants even called China, the migrated country, "home."

3. THE ARTWORK

This is Home is a film that follows a Filipino girl, River, who returns to her motherland after being abroad for most of her life. We watch as she struggles to insert herself within her new environment, amongst new people, and the new culture. We follow her as she discovers tiny reminders from her new home that reminded her what it was back then. She is comforted to know that she doesn't need to start over completely.

The film is a two-dimensional animation, with a run time of around 3:30 minutes. The animation comprises different styles, such as fully colored scenes, monochromatic scenes, and black and white scenes. The animation tackles Chinese and Filipino cultures, showing their differences and similarities. With the subject of the two cultures, it was vital for me to make the film more universal by not using any dialogue. As we move through the story, we discover many characters that all contribute to River's growth in her new environment.

4. ACKNOWLEDGMENTS

I would like to thank my father, as he was the reason why I did this research. As an Overseas Filipino Worker, his sacrifices for this family to keep our family afloat always inspire me to do something impactful. This is why I dedicate this research to his honor.

I would also like to thank my mother, who had a big hand in raising my sibling and me as our father was abroad. Even though she was hurting from the separation, she remained a steady rock to lean on for us. Her sacrifices will not be overlooked.

I would like to thank my research adviser, Ms. Jerilou Buted, as she was the one who stuck by my side as I trod through this unfamiliar path on writing my thesis paper. She had always been very patient, as well as supportive of my ideas. She put in as much time and effort in helping me as I had while writing this paper.

I would like to call attention to the composer of my score for the animation, Carl Sonmuel Peregrino. He did a wonderful job at knitting together a score that fits my vision and supports my story. Without him, my animation would not be complete.

I would also like to thank my friends, who stuck with me while I recovered from the separation. They did not invalidate my feelings and instead pushed me forward. I wouldn't be as comfortable creating this personal narrative without their aid.

5. REFERENCES

- Fang, Lue. "Acculturation and Academic Achievement of Rural to Urban Migrant Youth: The role of school satisfaction and family closeness." *International Journal of Intercultural Relations*, vol. 74, no. 2020, 21 Dec, 2018, pp. 149-160. ScienceDirect, doi: <https://doi.org/10.1016/j.ijintrel.2019.11.006>.
- Lados, Gábor, and Hegedűs, Gábor. "Returning Home: An Evaluation of Hungarian Return Migration." *Hungarian Geographical Bulletin*, vol. 65, no. 4, 2016, pp. 321-330. doi: 10.15201/hungeobull.65.4.2.
- Lee, Helen. "I was forced here: Perceptions of Agency in Second Generation 'Return' Migration to Tonga." *Journal of Ethnic and Migration Studies*, 25 Apr, 2016, pp. 1-14. Routledge Taylor Francis Group, doi: 10.1080/1369183X.2016.1176524.
- Pottie, Kevin, et al. "Do First Generation Immigrant Adolescents Face Higher Rates of Bullying, Violence and Suicidal Behaviours Than Do Third Generation and Native Born?" *J Immigrant Minority Health*, vol. 17, 24 Sept, 2014, pp. 1557-1566. CrossMark, doi: 10.1007/s10903-014-0108-6.
- Zhao, Siman, et al. "Maternal Parenting and Social, School, and Psychological Adjustment of Migrant Children in Urban China." *International Journal of Behavioral Development*, vol. 39, no. 6, 2015, pp. 541-551. SAGE Publications, doi: : 10.1177/0165025415576815.



Unsaid Woes: The Lives of Young Women Under the Constraint of Rape Culture

Jorel Gabrielle Mari Magistrado
De La Salle University Integrated School, Biñan City, Laguna

Abstract: An added difficulty to the pandemic is the persisting issue of rape culture. Although there are presently minimal face-to-face interactions, cyberspace could still be a hostile environment for women. It is easier to harass or demean people online since users can retain anonymity, making rape culture thrive online. This research in progress discusses the effects of rape culture on the lives of young women, factoring in patriarchal and conservative beliefs prevailing in the Philippines. Such behavior is looked at both from a real-life and online perspective, following a feminist lens. Qualitative methods were conducted to establish findings that determined slut-shaming, victim-blaming, and the hyper-sexualization of women as the general effects of rape culture. The artworks serve as a visualization of the struggle and situations women undergo because of rape culture. They were made digitally, with the subject matter based on the results yielded from the qualitative methods and critical discourse. The research output is an artbook called *Unsaid Woes*, a reference to the burdens of rape culture. The artbook is divided into three chapters tackling the presence of rape culture in a woman's life, starting from their upbringing up to adulthood.

Key Words: rape culture; feminism; artbook; digital illustration; Philippine social issues

1. OVERVIEW OF THE ARTWORK

1.1 *The Concept*

The artwork revolves around the effects of rape culture on the lives of young women and how it is manifested in their everyday life. I chose the zine as a medium since it allows me to make art of the different aspects of rape culture while keeping a cohesive theme throughout the piece.

The title refers to gender microaggressions towards women that often go unchecked. The zine is a collective visualization of women's experiences of rape culture living in the Philippines.

1.2 *Objectives*

The following are the artworks objectives: 1) to amplify the voices of women and to communicate the flaws in the ideologies they are chained to, serving as an encouragement for women to take back their freedom and for society to make the world a safer space for them, 2) to teach young adolescents the value of standing up to rape culture, all the while learning the value of respecting other people's bodies and boundaries, as well as their right to receive the same respect for themselves, and to serve as a tool for education since it adds insight to the feminist perspective and the knowledge about the effects of rape culture.

1.3 *Inspiration*

The overall inspiration of the artwork comes from other works of feminism online. The art style and color palettes were influenced by various artists, such as Ree A., Eunpyon, and Julian Glander. On the other hand, the dark subtone were inspired by the works of Arkestar, alongside the music videos from Melanie Martinez and Red Velvet.

The zine was made for all the women hanging on by a thread, doing their best to get by. It was made with the thought of women who want to be heard and left alone. Art could be used as a platform of protest since it could communicate certain ideas better than words.

2. UNDERSTANDING THE ARTWORK

2.1 *Review of Related Literature*

The lens used to examine the artwork is feminism, specifically Simone De Beauvoir's works. *The Second Sex*, in particular, discusses how women are seen as lesser than men—the Other.

De Beauvoir states, "One is not born, rather becomes a woman." Womanhood is dictated by society rather than being inherited by women. These set standards for women box them rather than seeing them as dynamic people. This leads to the objectification of women, like the scrutiny of their clothing choices or the attached value to their virginity (Manalastas). Additionally, society's perception of



women becomes oversexualized, especially with the male gaze. Pre-established expectations and conservative beliefs characterize a woman's body to be inherently provocative (Whisnant).

Even from a young age, these ideologies are taught to Filipinas. Parents play a vital role in developing a child since they are the child's first educators (Cole). Conservative beliefs are more likely first taught to children by their families. Girls and boys are brought up differently, and parents slowly integrate gender roles into their life (Conception et al.). Daughters are immediately taught how to cook, clean, and do other housework. From a young age, gender roles are already tied to them. Apart from that, they are taught the way of being a woman. They are constantly surrounded by these ideals until their development in adolescence and adulthood through the many different sectors of society.

For example, the church would often regard virgins of higher value. This implies that sexually active women are "lesser," despite virginity being a social construct (Manalastas). Women have argued the value of virginity, saying that patriarchal ideologies influence it. In "Revolt From Hymen" (1940), Angela Manalang Gloria wrote that the concept of virginity comes from a man's ideals of women's virtues. Through this, the worth of their bodies is established (Santiago).

Furthermore, there exists the ideology that such clothing expectations of women exist for their "protection" from the impure interests of men. Most notably, Ben Tulfo, a TV and radio host, released the controversial statement that women should cover up to avoid catcalling or sexual abuse. This is refuted by the Don't Tell Me How to Dress exhibit held by Cindy Sirinya Bishop. The exhibition displayed the clothes victims wore when they were abused. Although victims wore non-provocative clothing, they were still abused since rape isn't caused by clothes but by rapists.

The media has also played a role in creating stereotypes of women, more specifically, because of the male gaze. According to the American Psychological Association, girls are sexually depicted in the media more than boys. Researchers at Wesleyan University discovered that 51.8% of women are sexually portrayed across 58 various magazines. Further, this increased to 76% when it came to men's magazines (Gould and Swift).

In Philippine television, women are usually portrayed either as mothers or vixens (Flores 1). According to Prieler and Centeno, as Flores stated, women are typically submissive when presented as domestic figures. They serve as plot points for a male character to lean on, but nothing more. On the other hand, when portrayed as vixens, these female characters pander to the male sexual desire (Castro).

The accumulation of portrayals like these in the media normalizes this stereotype of women, drilling this false idea that women are sexual objects and raising the chances of women being the subjects of sexual violence.

The effects of rape culture are slut-shaming and victim-blaming. Women are treated as the provoker more than the victim. They are subjected to critical judgment, insinuating that a woman's job is to make herself look decent, not to be raped, rather than blaming the rapist's mindset. This puts further mental strain on the victim, which may cause PTSD, depression, and anxiety (Casal).

For example, aside from Ben Tulfo's comments on clothing, Anthony Taberna had his say regarding women getting raped. The "Umagang Kay Ganda" host chastised a 19-year-old victim of gang rape, saying: "*Ito po ay hindi first time na nangyari, napakadaming pagkakataon na 'yang eyeball eyeball na 'yan, ang mas delikado, nakipag-eyeball ka na nga, nakipag-inuman ka pa. 'Yan ang problema, 'yun ang mabigat sa lahat, lalo't puro lalake ka-inuman mo.*"

Instead of pointing out the injustice done unto her, Taberna criticized her for meeting them and drinking. The woman was shamed twice; the first time with the crime committed against her, the second publicly broadcasting that the said crime was her own fault. He then added, "*Kapag ka ikaw ay babae, wag kang papasok sa lungga ng mga tulisan.*"

Time and time again, women have been told to avoid social situations that would "put them in danger." A woman should not drink; a woman should not go out at night; a woman should not pass through dark alleyways or vast fields, or else something terrible will happen to her. Society's ideas of what a woman cannot do are more than what a man should not do to make a safer place for women.

The notion of "*Kababaeng tao kasi...*" tarnishes the respect and understanding women, especially victims, deserve to have. Further, victim-blaming may discourage rape and sexual assault victims from speaking up. Even in court, rape survivors are grilled more by the prosecutor, according to Atty. Estella Elamparo.

Rape culture can be eradicated through respect and empathy. Acknowledging one's boundaries and taking consent into consideration play a crucial role in this.

Conservative and patriarchal-centered beliefs are taught and instilled into women through hegemony. Men remain ignorant because of how society has continuously condoned their actions. But, as De Beauvoir states, although "the exploitation of women is historical," it could also be changed. Meaning, even though rape culture has accumulated over decades, this could still be amendable. A woman's



freedom lies within a woman – and is not given to her by a man.

It is important to note that ending rape culture is the responsibility of everyone. As women use their voices, it is society's responsibility to listen. Women should realize that they are free to reject compliance to patriarchal standards, while men should accept that they do not have to remain submissive (Bergoffen et al.).

2.2 Other Methodologies

Three qualitative methodologies were conducted, namely: a focus group discussion with different youths of the LGBTQIA+ community; a questionnaire answered by Ms. Sheryl Alapad, a GABRIELA Women's Party Member; and an interview with Ms. Leah Barbina, a representative of the Commission of Human Rights – Gender Equality and Women's Human Rights Center.

These focus group discussion participants were chosen in order to determine if the effects of rape culture vary between different gender communities. On the other hand, the interview and questionnaire were chosen to gain a sociopolitical perspective. All of the methods above were conducted entirely online. The focus group discussion and the interview were conducted via Zoom, while the questionnaire was sent through G-mail.

3. THE ARTWORK

The artwork is a zine showing different scenarios young women go through under the burden of rape culture. Three chapters chronicle such occurrences starting from childhood to adulthood. The three chapters are 1) "Toys and Trinkets," which uses toys as metaphorical visuals, 2) "Body Buffets," which shows women as commodities, and 3) "World as We Know It," which visualizes the world from a woman's perspective, depicting fear and male-set standards she is expected to adhere to.

The color palette used starts off with bright, pastel colors progressing into darker colors. This mimics the way some aspects of rape culture are brushed over until one takes a step back and becomes fully aware of the magnitude of its effects. The art styles used were cartoony and surrealist to convey and visualize women's fear and insecurity in their day-to-day life. The artworks were made not to be literal but as metaphors for complex feelings—a representation of something supposed to be familiar but with an undertone of danger or wrongness.

4. ACKNOWLEDGMENTS

I would like to thank Ms. Reinette Natividad, my research adviser, for her efforts in helping improve

the research and the artwork. She graciously helped in resolving each concern I had.

I would also like to thank Sir Hanzel Gapayao, my research mentor, who constantly pushed me to be on track.

Next is my mother, Raquel Magistrado, who enthusiastically supported me behind the scenes. The love she has given me has put my mind in a good place, giving me the strength to persevere amidst the trials and tribulations of this paper.

To De La Salle University Integrated School, thank you for the opportunity to write a research about something I am truly passionate about.

Special thanks to Paula Leano and Kate Loyola who listened to all my ramblings about potential artworks.

Lastly, I express much gratitude to Kyle Garcia, who has helped me get back up whenever things became too much.

I am truly thankful I had you all on this journey.

5. REFERENCES

- "Importance of Early Childhood Development: Introduction." Encyclopedia on Early Childhood Development, Mar. 2011. www.child-encyclopedia.com/importance-early-childhood-development/introduction.
- 7 Artists Using Their Practice to Address Gendered and Sexual Violence. 10 Apr. 2017. wam.umn.edu/2017/04/10/7-artists-using-their-practice-to-address-gendered-and-sexual-violence/.
- Adams, Lucy. "Sex Attack Victims Usually Know Attacker, Says New Study." *BBC News*, BBC, 1 Mar. 2018. www.bbc.com/news/uk-scotland-43128350.
- Antegra, Geraldine. What Feeds Rape Culture in the Philippines? 17 Sept. 2018. atenews.ph/whatfeeds-rape-culture-in-the-philippines.
- Balisong, Patrick Edward L., and Amparita S. Sta. Maria. "Finding Maria Clara — The Doctrine and the Filipina." *Ateneo Law Journal*, vol. 63, no. 2, 2018. doi:<http://ateneolawjournal.com/Media/uploads/b11211d49d656184a6717ca03255d548.pdf>.
- Bergoffen, et al. "Simone De Beauvoir." *The Stanford Encyclopedia of Philosophy*, 2020. doi:<https://plato.stanford.edu/archives/sum2020/entries/beauvoir/>.
- Borysenko, Karlyn. The Dark Side Of #MeToo: What Happens When Men Are Falsely Accused. 12 Feb. 2020. www.forbes.com/sites/karlynborysenko/2020/02/12/the-dark-side-of-metoo-what-happens-when-men-are-falsely-accused/.
- Brandon University. SEXUALIZED VIOLENCE SUPPORT AND INFORMATION. www.brandonu.ca/sexualviolence/education-prevention/rape-culture/.
- Cole, Jennifer. "A Research Review: The Importance of Families and the Home Environment." National Literacy Trust (2011).
- Conception, A, et al. "1999 Philippines: How to Raise Our Daughters and Sons: Child-Rearing and Gender Specialization in the Philippines." 1999,



3RD DLSU SENIOR HIGH SCHOOL RESEARCH CONGRESS

www.unicef.org/evaldatabase/index_14239.html. Accessed 13 Sept. 2020.

David, Rina Jimenez. "Living With Sin: THE CATHOLIC HIERARCHY AND REPRODUCTIVE RIGHTS IN THE PHILIPPINES." *Conscience* 24.2 (2003): 18.

Flores, Zhaira Wincy. "Sexualization and Objectification of Women in the Philippines." (2019).

Gould, Hannah, and Jaimmee Swift. Not An Object: On Sexualization and Exploitation of Women and Girls. 15 Jan. 2020, www.unicefusa.org/stories/not-object-sexualization-and-exploitation-women-and-girls/30366.

Gwon, Seok Hyun, and Suyong Jeong. "Concept Analysis of Impressionability among Adolescents and Young Adults." *Nursing Open*, vol. 5, no. 4, 2018, pp. 601–610., doi:10.1002/nop.2.170.

Interaksyon. "Gabriela Fears SC Ruling on 'Maria Clara' Doctrine Could Lead to More Rape Cases." Interaksyon, 21 Feb. 2018, www.interaksyon.com/breaking-news/2018/02/21/120683/gabriela-fears-sc-ruling-on-maria-clara-doctrine-could-lead-to-more-rape-cases/.

Kim, Sam. "Comics/Superheroes: Women Superheroes Still Subjugated by the Male Gaze as Masculinity Prevails." Medium, Medium, 3 Sept. 2017, medium.com/@skim225/comics-superheroes-women-superheroes-still-subjugated-by-the-male-gaze-as-masculinity-prevails-4c8607d93a43.

Luna, Nikki. Patriarchy, Manny Pacquiao and Madonna. 22 Mar. 2016, rappler.com/voices/imho/patriarchy-manny-pacquiao-madonna.

Manalastas, Eric Julian. "Valuation of Women's Virginity in the Philippines." *Asian Women*, 34, no. 1, 2018, pp. 23–48., doi: https://doi.org/10.14431/aw.2018.03.34.1.23.

Marks, Gene. "When Men Are Afraid to Interact with Women at Work, It Harms the Whole Company | Gene Marks." *The Guardian*, Guardian News and Media, 5 Sept. 2019, www.theguardian.com/business/2019/sep/05/when-men-are-afraid-to-interact-with-women-at-work-it-harms-the-whole-company.

Pagdanganan, Macel. "Women Subjected to Shaming, Harassment the Most under Duterte Gov't – Expert." Rappler, Rappler, 21 July 2019, rappler.com/nation/women-subjected-shaming-harassment-most-under-duterte-government.

Palatino, Mong. Duterte's Anti-Women Behavior Sparks the Philippines' Own #MeToo Moment. 27 June 2018, thediplomat.com/2018/06/dutertes-anti-women-behavior-sparks-the-philippines-own-metoo-moment/.

Posadas, Jeremy. "Teaching the Cause of Rape Culture: Toxic Masculinity." *Journal of Feminist Studies in Religion*, vol. 33 no. 1, 2017, p. 177-179. Project MUSE muse.jhu.edu/article/653664.

Reformina, Ina. SC: 'Maria Clara' Doctrine Alone Not Sufficient for Rape Conviction. 20 Feb. 2018, news.abs-cbn.com/news/02/20/18/sc-maria-clara-doctrine-alone-not-sufficient-for-rape-conviction.

Ruiz Austria, Carolina S. "The church, the state and women's bodies in the context of religious fundamentalism in the Philippines." *Reproductive Health Matters* 12.24 (2004): 96-103.

Suresh, S. "How Should Society View a Woman's Body?" *Fair Observer*, 11 Nov. 2018, www.fairobserver.com/region/north_america/womens-dress-code-sexism-sexual-harassment-feminism-news-54131/.

Taub, Amanda. Rape Culture Isn't a Myth. It's Real, and It's Dangerous. 15 Dec. 2014, www.vox.com/2014/12/15/7371737/rape-culture-definition.

United Nations Women. "Focus Areas: End Violence against Women." UN Women | Asia and the Pacific, asiapacific.unwomen.org/en/focus-areas/end-violence-against-women.

Whisnant, Rebecca. "Feminist Perspectives on Rape." *The Stanford Encyclopedia of Philosophy*, 2017, doi:https://plato.stanford.edu/archives/fall2017/entries/feminism-rape/.

Yamsuan, Cathy Cañares. Culture of Blaming Victims Hinders Rape Cases. 13 July 2020, newsinfo.inquirer.net/1305894/culture-of-blaming-victims-hinders-rape-cases.



Lawin at Sisiw: A Role-playing Game Solving the Filipino Disunity Caused By the Great Cultural Divide Through Pakikipagkapwa

Elyza Bernice B. Cua, and Alicia Andrea L. Ramos
De La Salle University Integrated School, Manila

Abstract: Sikolohiyang Pilipino explains that the transitory unity among Filipinos is caused by the different perspectives of the two sides of the “great cultural divide,” being the elites and the non-elites. The primary research objective is to present pakikipagkapwa as a possible solution to the great cultural divide. Lawin at Sisiw Role-Playing Game was designed: (1) to mirror the dynamics between the elite and the non-elite, (2) to impart its message of practicing pakikipagkapwa and sustaining this value as possible solutions to the disunity amongst the Filipino people through its narrative, and (3) to portray the importance of pakikipagkapwa through the mechanics. Lawin at Sisiw translates Filipino concepts into a high school context. Pagtatanong-tanong or unstructured interviews with eight senior high school students regarding Filipino and classroom disunity were conducted. There is a lack of Filipino video games discussing Filipino disunity, revisiting old Filipino philosophical concepts, or recreating traditional Philippine games. Lawin at Sisiw presents the indigenous value of pakikipagkapwa as a possible solution to the sporadic unity of the Filipinos through its narrative and mechanics in social simulations and turn-based combat.

Key Words: Filipino disunity; Sikolohiyang Pilipino; great cultural divide; pakikipagkapwa; role-playing game

1. OVERVIEW OF THE ARTWORK

Lawin at Sisiw Role-Playing Game translates the disunity made by the cultural divide in Filipinos into academic competence in students. This way, the top-ranking students are equivalent to the real-life Filipino elites, the low ranking students to the non-elites or the masses, the school administration to the government, and the supernatural Lawin to the “common enemy” Filipinos need to unite. The top and low ranking students have differences but have a common goal of overthrowing the Lawin. To achieve this, the player has to unite the students from varying academic ranks, practicing the Filipino value of *pakikipagkapwa*. Tapales and Alfiler (104) proposed three possible steps for solving the differing perceptions of the elite and non-elite Filipinos to achieve unconditional unity. First is to utilize the indigenous values held by Filipinos, next is to translate these values into an ideology to foster unity, and finally, to sustain this unity through programs and projects to empower the people (107). In line with this, after the students can achieve the highest level of *pakikipagkapwa*, the school then sustains the students’ unity by implementing an ideology centered on *pakikipagkapwa* at the end of the game.

Lawin at Sisiw Role-Playing Game is a battle-centric video game. Inspired by the traditional game, *Lawin at Sisiw Role-Playing Game* involves strategic composing and positioning of team members and the

concept of “stealing” between the Lawin and humans. The literal “*lawin*” and “*sisiw*” bird concept and school motif are present in the game’s overarching design—in the gameplay terminologies, the Lawin design, the character names, and the design interface.

The primary research objective is to present *pakikipagkapwa* as a possible solution to the great cultural divide. To achieve this, *Lawin at Sisiw Role-Playing Game* must accomplish these three objectives: (1) to mirror the dynamics between the elite and the non-elite based on *Sikolohiyang Pilipino*, (2) to impart its message of practicing *pakikipagkapwa* and sustaining this value as possible solutions to the disunity amongst the Filipino people through its narrative, and (3) to portray the importance of *pakikipagkapwa* through the mechanics.

2. UNDERSTANDING THE ARTWORK

The researchers first gathered sources on *Sikolohiyang Pilipino*, the study of Filipino behavior from a Filipino lens (Pe-Pua and Protacio-Marcelino 50), and about Filipino disunity to grasp the underlying reason for the divide and to find possible solutions to the problem.

Pagtatanong-tanong is an improvised, informal, and unstructured interview (qtd. in 60). With this method, the researchers were able to directly obtain the insights of senior high school students in a free-flowing manner. The research and



its purpose were first introduced, followed by an exchange of opinions regarding Filipino disunity, the great cultural divide between the elites and the non-elites, and core Filipino values. To obtain inspiration for the connection of Filipino disunity to a high school setting, the informants were also asked about the prevalence of disunity in the classroom, if there is any. Since the method is not merely a one-way interaction (Pe-Pua 153), the informants were allowed to go off topic when sharing their views.

From the insights collected from the eight senior high school students, it can be seen that the Filipino disunity caused by the great cultural divide is still prevalent today, especially from the younger generation's point of view. The participants discussed the differences between the elite and non-elite Filipinos, how the connotations of *pakikitungo* and *pakikibahagi* are present in their relationships, how the government favors the elite class, and how the idea of a common enemy being an initiator for Filipino unity is existent. The parallel connection of these to the school setting was also discussed. The treatment of the Filipino elites and the masses has been compared to the academically competent or extracurricularly active and average to below-average students. The participants noted possible solutions to Filipino disunity or disunity in the classroom, starting from the Filipino individual to the administration.

3. THE ARTWORK

Narrative. In Luan High School, where academic competence is the social currency, Lino, short for Aquilino, is as ordinary as can be—getting average grades in school and having a few close friends. All is normal until a new principal is appointed in his school. Less than two weeks after the new principal's appointment, drastic changes occur; the teachers, admin, staff, and other personnel are replaced one by one. Coinciding with this is the transfer of a mysterious student. Shortly after, the school announces that they will be holding a study training camp that requires students to stay on campus for one month. They are not allowed to go outside. The school gets the approval of all parents, and the student body has a very competitive nature, so the training camp quickly commences. The principal is the leader of the Lawin species, and they have invaded the school. They are supernatural beings with exceptional eyesight, strength, and speed. They have mechanical blade wings with feathers they throw and sharp claws they strike. Because there is an ongoing war in the Lawin world, the Lawin have to look for sources to strengthen themselves, which are the pure souls of young humans. When the humans' souls are extracted, their lifespan decreases. Because of this exploitation of humans, Warden, the transferee, puts up a front that he is secretly going

against his kind. He asks for Lino and the school delinquent Jason's help to overthrow his father. Warden, the transferee, shares his plan to recruit more members to defeat the Lawin. The members to be recruited are Maya, the current top-notch at the academic ranking; Dominik, the son of the school president; Robin, the captain of the track and field team; and Nicole, the student council president.

Assignments. The player goes through seven primary "Assignments" or missions against the heads of the seven Lawin Families, namely, the Cariama, Sagittarius, Strigis, Falco, Cathartes, and Pandion. The seventh head is the principal of the Accipiter Family. These Families are based on the eight families of birds of prey ("Strigis" is a combination of the two owl families, Strigidae and Tytonidae). Each Lawin Family has different skills and abilities, making each battle experience new to the player. After defeating each Family Head or completing each Assignment, the player acquires a special Talon—all six of which are needed. In an unexpected turn of events, it is later revealed that Warden has been using them the whole time for his own gain, making him the eighth and final boss to be defeated. Since he has been acquiring the other player characters' skills by accompanying them in their journey, he uses these against them in the final battle. This battle will prove that the students can stand alone without Warden's assistance.

Battle Mechanics. To bring all six player characters to an Assignment would blow their cover, so to be discreet, the player selects three characters to battle with before heading into an Assignment. Lino is a mandatory member of the team. During the turn-based battle, the three characters rotate every turn. The first character in the order will be the defensive character. The third character deals bonus damage. This battle aspect allows the team members to have equally spread out responsibilities, using their strengths wisely and protecting each other. Aside from this, the characters have different skill levels and abilities. The player has to be strategic to balance the team's strengths and make the order match their strengths. There are three types of moves in battle—Brawl, Airstrike, and Soul. There is also a Spirit Bar which indicates the characters' energy. Brawl and Airstrike moves give Spirit Points, while Soul moves deduct Spirit Points. When the Spirit Bar is full, the player can perform the characters' Flock Attack, which is a potent move wherein all characters use their strengths. Moreover, different moves give varying amounts of Affinity Coins, which are used to obtain more powerful and effective moves in battle.

Social Simulation. The game has a social simulation wherein you interact with the other characters to level up your *Kapwa* points. The level of *Kapwa* indicates the level of the relationship among the squad members. Aligned with the eight concepts



in *ibang-tao* and *hindi-ibang-tao* mentioned in *Sikolohiyang Pilipino* (as discussed in Pe-Pua and Protacio-Marcelino 56), there are eight levels of *Kapwa*: Transaction, Interaction, Participation, Conformity, Fellowship, Acceptance, Involvement, and Unity. The moment the player recruits a member, they are automatically in level Transaction. As the player treats squad members as *hindi-ibang-tao*, they gain *Kapwa* points, and the level increases. To earn *Kapwa* Points amongst the player characters, the squad acquires better teamwork by learning each other's moves.

Classroom Simulation. The player follows a schedule to attend a class, have lunch breaks, and defeat Lawin after class. Players receive Class Points when reciting in class within a time limit. The teacher asks a multiple-choice question, and the player can raise their hand to answer the question. Different answers can either add, reduce, or maintain Class Points. Reflecting on how academic competence determines the students' social status in this school, the Class Points are the currency for buying Items from the school canteen and Dominik.

Character Designs. The main characters' designs are kept simple and realistic but still provide sufficient details to differentiate them. This way, the player can relate to the characters and see themselves in their position. The students' uniforms vary depending on their rank; the low-ranking students wear a simple buttoned shirt and slacks or skirt combination. The top-ranked students wear an additional plaid vest and several metal pins according to their academic awards. The main characters also wear their uniforms differently, portraying their personalities and roles. As for the Lawin's, their uniforms as school staff are meant to appear as complete opposites to the students' uniforms. The Lawin armor sets are mechanical, with bright-colored glows on their wings, talons, and other details in their armor and masks. Each Lawin Family has a corresponding color and a different wing placement. Lino's Lawin transformation is intended to appear like it has missing parts, unlike the Lawin enemies with complete, full-body armor, because of his half-human and half-Lawin descent. Warden's Lawin transformation is also not as complete as the enemies' because of his young age, recklessness, and lack of experience on the battlefield.

Names. The names of the school and the characters are based on Philippine flora and fauna. The school's name, Lauan, is a name used for the Philippine mahogany tree. Lino's name is derived from the Filipino word *agila*, meaning eagle. Jayson's name comes from crested jay. Dominik, the school president's son, gets his name from *dominiko* bird or the Oriental magpie-robin, a small bird endemic to Southeast Asia. Maya comes from the Filipino word

for "sparrow," a small, endemic bird species. Nicole's name comes from the coledo bird, which is another small bird endemic to the Philippines. Lastly, Robin's name comes from the Philippine magpie robin, another small bird. On the contrary, we have Warden, who has a foreign-sounding name which means "guardian." This symbolizes how he is not from this world, and at the same time signifies his role in protecting the players while fighting against Lawin.

4. ACKNOWLEDGMENTS

We would like to express our deepest gratitude to our research adviser, Mr. Lorenzo Ramon Gutierrez, for his continuous guidance throughout our research and art-making processes and for pushing us to keep striving to improve our skills in the arts and in research. If it were not for his teachings, our final work would have taken a different direction and would not have been as refined as it is now.

We would also like to thank our research mentor, Miss Jerilou Marie Buted, for teaching us theories and frameworks, which are the foundation of our research. Miss Buted was also present as a panelist in our first defense during the first term of the academic year. She helped us significantly improve our artwork, specifically the character designs and namings.

We are also thankful to Mr. Ray Christian Cristobal and Mr. James Christian Dagondon, for their input as our defense panelists. Mr. Cristobal gave recommendations regarding the colors and overall look of our video game. Meanwhile, Mr. Dagondon gave his insights on the research side.

We would like to thank Miss Virginia Lacsamana, our visual arts teacher, Miss Candice Perez, our research mentor from the previous school year, and Miss Liezl Rillera-Astudillo, the Senior High School Research Coordinator for STEM, for their additional guidance in our artwork and research. Miss Lacsamana assisted us in the technical side of our artworks, specifically in human anatomy and perspective. Miss Perez and Miss Rillera-Astudillo answered our concerns regarding the sample size of our methodology. Miss Rillera-Astudillo also recommended pieces of literature on *Sikolohiyang Pilipino*, which further deepened our research. We are vastly grateful to De La Salle University for their supervision and for allowing this research to be possible.

Lastly, we would like to thank our friends and family for their unending support in our research journey and motivating us to continue striving and finishing our research.



5. REFERENCES

- Pe-Pua, Rogelia, and Elizabeth A. Protacio-Marcelino. "Sikolohiyang Pilipino (Filipino psychology): A legacy of Virgilio G. Enriquez." *Asian Journal of Social Psychology* 3.1 (2000): 49-71.
- Pe-Pua, Rogelia. "Pagtatanong-tanong: A cross-cultural research method." *International Journal of Intercultural Relations* 13.2 (1989): 147-163.
- Tapales, Proserpina Domingo, and Ma. Concepcion P. Alfiler. "Sustaining Filipino Unity: Harnessing Indigenous Values for Moral Recovery." *Philippine Journal of Public Administration*, vol. 35, no. 2, Apr. 1991, p. 99-113. HeinOnline.



Sa Araw ng Pag-ani: A Short Film on Representations of Hope in Media Inciting Climate Activism

Erich Danielle L. Altares, and Nicole Ann E. Vargas
De La Salle University Integrated School, Manila

Abstract: As youth who inherit whatever world the previous generation leaves us, there is widespread climate grief as climate change, among other environmental concerns, continues to be downplayed and overlooked by governments and policymakers. This research aims to find representations of hope in media, particularly film, to motivate climate activism in the Philippine context. Switching between two timelines, *Sa Araw ng Pag-ani* is a short film about two people who have lived through different states of the planet. Where one warns us of an impending disaster brought by the negligence of our environment, another tells us of the bountiful harvests of a world that learned to care for itself. Ultimately, this film hopes to convey the vision of a better future where the end is, contrary to current belief, no longer in sight.

Key Words: climate activism; agenda-setting; hope; media representation; film

1. OVERVIEW OF THE ARTWORK

As youth who will inherit the world the previous generation leaves us, there is widespread climate grief as environmental concerns continue to worsen with no sign of change from institutional powers. Climate change is a prevalent issue that has slowly built up with time, induced by factors both natural and man-made (Intergovernmental Panel on Climate Change (IPCC)).

Film has long been deemed an effective communication tool, especially in shaping culture and identity (Holtzman and Sharpe 8). Unlike orthodox research, film has imagery and visual representation, necessary when introducing audiences to new perspectives. Since climate activism is propelled by extreme emotions, such as fear, anger, and guilt (Kleres and Wettergen), film, as a visual medium, can maximize these and communicate in a manner that can reach its audience.

This research aims to find symbolisms or representations of hope in media, specifically film, that can motivate climate activism in the Philippine context. In the process, the research study explored the media's portrayal of climate change and how representations of hope could impact the discourse and the perception of Filipino audiences on environmental issues. The short film produced aims to inform and inspire hope in its audience, as it intends to incite an understanding and, subsequently, a passion for climate justice. Addressing climate change needs proper legislation, and only people mobilized by idealism can fight for it.

Sa Araw ng Pag-ani is a short film told in two tales. Lynn, an artist-turned-climate-activist, tells the story of catastrophe and calamity—a cautionary tale

to whoever is listening. Erin instructs us how to cook his *lola's sinigang*, all the while weaving in a secondhand story of suffering. *Sa Araw ng Pag-ani* illustrates the world we might face and the world we would have to aim for.

2. UNDERSTANDING THE ARTWORK

To solidify the foundations of the artwork, the artists took to literature examining climate change, media, and hope in the Philippine context. Further, different environmental films and their representation of environmental concerns were studied. Last, the researchers interviewed credible individuals from environmental organizations and accomplished filmmakers to understand how climate change is understood from the Filipino perspective and how the available platforms can be maximized.

The vulnerability of the country's agriculture is substantial (Mallari 441), and to address these, the government has resorted to different adaptation tactics (Benioff qtd. in Jose and Cruz 82). Kleres et al. posit that extreme emotions such as fear and guilt can motivate action and that hope is essential in managing those and inspiring mobilizing anger (508).

The media's role in disseminating information gives it the power to control the frame through which environmental problems are understood (Happer and Philo 321). Language also plays a role, as specific terms can alter different issues' framing (Lakoff 71). Due to the media making it an "issue of uncertainty" (Boykoff qtd. in Happer and Philo) and the polarisation in news reporting, scientific arguments are ignored mainly in policymaking (Happer and Philo). Social movements must have coherent framing for them to succeed (Lakoff).



Effective social movements confront fear and uncertainty with action, and often they generate the most “radical” of responses: Hope (Wright 224). Wright stresses the importance of redefining the situation, making fear no longer central to people’s lives (224). Redefining and reconstructing are vital in encouraging them to strive for change actively. It motivates them in situations that have them at a disadvantage and allows them to overcome those hurdles.

For the review of environmental films, the researchers first looked into ‘climate fiction,’ such as *The Day After Tomorrow* (2004) and *Geostorm* (2017). Both films focused on a “doomsday” narrative with no solution, glorifying humanity’s will to survive. Contrary to this, *Princess Mononoke* (1997) states, through Ashitaka, that maintaining a balance between nature and society is an imperative way of life. The documentary films, namely *Before the Flood* (2016) and *David Attenborough: A Life on Our Planet* (2020), opted for a candid look into climate change by visually representing the damage. From these, the artwork utilized the documentaries’ honest portrayal of climate change, climate fiction’s foreboding threat of a looming disaster, and the animated film’s underlying hope.

The researchers consulted with numerous people, including Ms. Virginia Benosa-Llorin and Ms. Angeli Cantillana of GreenPeace PH, who emphasized the importance of human connection in communicating the climate crisis. Along with them, Mr. Jacques Fallaria of Youth Strikes 4 Climate Philippines posited that an improvement in delivering information, i.e., transmitted using Filipino and more straightforward terms, could greatly benefit the general public.

Ms. Joanne Cesario and Ms. Alyssa Suico, creators of *Here, Here* (2019), both agreed that coverage on environmental issues is lacking and often misrepresented. Ms. Cesario hopes to see more innovation in film and more novel representations of the climate crisis. She is looking forward to a day where the people involved are the ones to tell their stories. “When that day comes, that means it’s no longer a problem,” she explains. “If they have the power to tell their narratives, that means they have the solution (already).”

The artwork could not have come to life without the hours of research, pages of literature read, and the people who were gracious enough to lend us their knowledge. Much of the study informed the artists’ creative decisions in the formulation of the film, including its narrative, narration style, and technicalities.

3. THE ARTWORK

The film weaves the stories of two generations in a single tale, with the characters belonging to different periods. Where one warns us of an impending disaster brought about by the negligence of our environment, another tells us about the bountiful harvests of a world that learned to care for itself.

The short film opens with a woman painting. Lynn, the painter in question, is an influential climate activist. She tells stories through monologues: stories about a farmer’s struggle, the beginnings of action, confronting ignorance and awakening to reality, and a victory shortly should we play our cards right. Throughout the film, she paints four distinct faces, culminating in an image of the four stories she tells. The Lynn we see in the film is living during the most tumultuous time in the fight for environmental justice and carrying the fear that the worst has yet to come.

Intertwined in the narrative is Erin. As he goes through the motions of preparing his *lola’s sinigang*, he shares anecdotes from the woman herself. Erin’s story tells us of hope, of a future where Lynn’s fears are no longer of concern. Beyond that, he represents empowerment for those most vulnerable: reclaiming a painful past as it’s told in a lighthearted manner on a typical day. The short film closes with Erin and his completed *sinigang*, on a prepared table, with a familiar painting hanging in the background: *Lola* is coming home.

Sa Araw ng Pag-ani is a light drama film about two people who belong to different generations, who have experienced different planets. It aims to convey the hope of a future where the end is, contrary to current belief, no longer anywhere in sight. The film depends on the characters’ monologues, inviting the audience to listen and pay close attention to their words, and finally, lend an ear to those often unheard.

Lighting and color grading are used to distinguish between the two timelines. Lynn is surrounded by warm light from a nearby window, denoting the palpable heat brought about by climate change.

Contrasting this is a vibrant yet less saturated tone in Erin’s scenes—a visual representation that the problem has passed.

The film’s aspect ratio is 2.39:1 to emulate a cinematic look and invoke a more serious tone to the film, bringing attention to its emotions and message.

The artists highlighted essential details, particularly the backgrounds. Lynn’s backdrop is cluttered with papers, pictures, and paintings adorning her wall to symbolize her fraught and overwhelming situation. It also shows her character’s involvement with nature, as seen through the landscape photographs, and her care and empathy, as seen through the pictures of people.



Erin's set shows him to be neat and organized, someone used to living sustainably.

Throughout the filming process, the artists created parallels between the two timelines through shot sizes. Wide shots directly facing the character emphasize their surroundings and their dialogue.

In contrast, Lynn's wide shots show a cramped workspace where she only moves once to get the door. Wide shots from the side are used when the characters' dialogue mirror each other's, such as when Lynn talks of her vision of the future, and Erin recalls the past his grandmother had told him about.

Medium close-up shots of their faces are used periodically for emphasis. Close-up shots follow the characters' actions and vary in angle per timeline. Lynn's close-up shots are filmed from a low angle in order to highlight the faces she is painting and make them more powerful; a visual telling of empowerment.

In comparison, Erin's close-up shots are filmed from a high angle, particularly when the dish is complete, to encapsulate the bountiful harvest of the future Lynn hoped for.

The sound design is mainly ambient to curate their timelines' distinct atmospheres. City sounds are prevalent in Lynn's timeline to emulate busy Filipino streets, and to create the illusion of humidity. Erin's timeline is quieter, with nature sounds more evident to create an audibly peaceful environment. An original score of piano and violin is also interspersed throughout the film.

Overall, *Sa Araw ng Pag-ani* aims to provide an honest recount of the climate crisis and its adverse effects on those most vulnerable in the country, while providing an alternate reality that we should strive to attain. In this sense, the film aims to instill a feeling of hope in its viewers by reminding them that despite how dire the situation may be, we still have a chance to turn it around and that hopefully, that day of harvest would soon come.

4. ACKNOWLEDGMENTS

Where traditional media failed to reach audiences, film transforms words that previously held no meaning into a conviction. With that, we thank the existence of film and its makers, encapsulating stories that have to be told and heard and instilling a love for storytelling within us.

We also extend our gratitude to independent Filipino filmmakers; you continue to inspire us to keep doing what we love and to use our voices to amplify those who cannot be heard, despite facing innumerable challenges. When we forget our passion amid adversity, you remind us of it.

Our generation is critiqued for our outspokenness, to the point of being ridiculed. Despite this, we thank the climate activists, particularly the

youth who lead these organizations, for being the first to criticize and remind us all to use our anger for good - you are doing so much for a world that so often forgets to take care of itself.

Art has always been a medium for communication and an outlet for those who find themselves voiceless to reclaim it. That being said, we thank the artists who continue to pursue their passion, and especially those who utilize it to fight for the greater good. Despite what our society tells us, art is an integral part of our human experience, and it continues to be revolutionary.

Research is incredibly taxing, so we extend our gratitude to the people who have made this possible. We thank the participants who were a part of this research, as your input has been of immense help, to the actors, Sofia Romas and Laurence Cabral, for bringing these characters and our vision to life. We thank our friends and family who've supported us, who've reminded us to take breaks. We also extend our sincerest gratitude to Ms. Jerilou Buted, for being an incredible research mentor and class adviser, and to Ms. Candice Perez for being the best research adviser we could ask for. Your guidance is indispensable, and this would never have happened without you.

Finally, to each other: oh my god, we finally did it.

5. REFERENCES

- Happer, Catherine, and Greg Philo. "The Role of the Media in the Construction of Public Belief and Social Change." *Journal of Social and Political Psychology*, vol. 1, no. 1, 2013, pp. 321-36. *Crossref*, doi:10.5964/jssp.v1i1.96.
- Holtzman, Linda, and Leon Sharpe. *Media Messages: What Film, Television, and Popular Music Teach Us About Race, Class, Gender, and Sexual Orientation*. 2nd ed., Routledge, 2014.
- Jose, AM, and NA Cruz. "Climate Change Impacts and Responses in the Philippines: Water Resources." *Climate Research*, vol. 12, 1999, pp. 77-84. *Crossref*, doi:10.3354/cr012077.
- Kleres, Jochen. "Fear, Hope, Anger, and Guilt in Climate Activism." *Social Movement Studies*, 2017, doi:10.1080/14742837.2017.1344546.
- Lakoff, George. "Why It Matters How We Frame the Environment." *Environmental Communication*, vol. 4, no. 1, 2010, pp. 70-81. *Crossref*, doi:10.1080/17524030903529749.
- Mallari, C. Alyosha Ezra. "Climate Change Vulnerability Assessment in the Agriculture Sector: Typhoon Santi Experience." *Procedia - Social and Behavioral Sciences*, vol. 216, 2016, pp. 440-51. *Crossref*, doi:10.1016/j.sbspro.2015.12.058.
- Wright, Sarah. "Practicing Hope: Learning from Social Media Strategies in the Philippines." *Fear: Critical Geopolitics and Everyday Life (Re-Materialising Cultural Geography)*, edited by Rachel Pain and Susan Smith, 1st ed., Routledge, 2016, pp. 223-34.



Ang Kulungan sa Aking Kinagisnan: A Play With Music to Showcase Oppression of Freedom of Speech in the Arrest of the Protestors of Sitio San Roque, Barangay Pag-asa in Quezon City During April 1 of the COVID-19 Pandemic Metro Manila Lockdown

Lorenzo Gabriel F. Buenafe
De La Salle University Integrated School, Manila

Abstract: The general concept depicts the controversies and effects of the Sitio San Roque incident that unfolded on April 1, 2020. The artwork’s objective is to inform the people about the injustices that unfolded during the incident at Sitio San Roque Quezon City and connect it to deeper problems plaguing the country’s justice system. Different theater and filmmaking techniques such as tension, costume design, set design, and angles were incorporated. The fictional character Junemar is one of the arrested activists. His life reveals a decade-long battle with the country’s injustices and corruption. Itay is the father of Junemar, while Dr. Nayab is Junemar’s therapist. The events that unfolded scarred Junemar to the point that it gave him PTSD, and so he talks to loved ones, going to therapy, and practices other forms of coping.

Key Words: musical; theater; performance; corruption; injustices

1. OVERVIEW OF THE ARTWORK

The performance will have the elements of a musical and a theater play, such as singing and monologue while having the accompaniment of background music. The story revolves around the arrested activists during the lockdown. The performance was staged inside my house. It used a series of camera angles and lighting for spectacle.

The artwork aims to answer these research questions:

- A. What is the state of the justice system in the Philippines during the 2020 pandemic lockdown in Metro Manila?
- B. How could the experiences of the arrested activists on April 1 in Sitio San Roque be translated into a performative text on an online platform?
- C. How will this performance raise social awareness of the state of free speech in the Philippines?
- D. How will an online play with music performance tell the stories of the unheard voices of the activists who got arrested doing rallies during the lockdown of Metro Manila due to the pandemic?

The incident at Sitio San Roque was used to represent a bigger problem in the Philippines: the oppression of freedom of speech and the mishandling of the COVID-19 pandemic.

2. UNDERSTANDING THE ARTWORK

The hardest part while creating the artwork was putting all the ideas to form a cohesive and

comprehensive script that the audience can understand and appreciate while also sticking to what I would like to put in the work. Before I worked on the script, I decided to proceed first with the musical accompaniment. It helped me put the puzzle pieces together by formulating a scene that will complement the overall feeling of the song. Watching movies and playing video games also gave me a big boost of inspiration to incorporate ideas that I found interesting.

3. THE ARTWORK

I decided to go with a Christopher Nolan type of approach, specifically in the timeline, for the script. The way Nolan does his unconventional timeline gives the audience a chance to understand what happened. When there is a good story, people will ponder on the past of that particular story. Frequently, what you see in a Nolan film *feels* like it is chronological. Then you get to experience the thrill of realizing that what you assumed about the movie is not true.

When it comes to games, I like the way Red Dead Redemption sequenced its events. To give a short description, Red Dead Redemption 1 is about an outlaw trying to forget his past by being a good citizen but eventually, it catches up to him. His history is told in the first game is not too detailed, which gives the players a chance to give meaning to what happened. Eventually, in Red Dead Redemption 2, it reveals how the main character of RDR 1 got to where he is today.

The artwork is about a borderline middle-class perspective of a character named Junemar who



suffers from PTSD because of the incident at Sitio San Roque on April 1. The events that unfolded scarred him, so he tries to cope by talking to loved ones and therapy. The audience first sees him hurrying up to go to the place where the incident happened. The next scene is two weeks after the incident. In the third scene, we jump back a little bit earlier to a week after the incident.

In the fourth scene, it is a month after the incident in which it can be seen he has already sought help by going to a therapist. In the fifth scene, he just got home from his therapy session. While the sixth scene is two months after the incident in which he is once again in therapy. For the final scene, the day after his therapy session from the previous scene, he is seen sleeping and eventually wakes up but dies because of COVID. This might be a bit confusing when read at first, but the artwork allows you to understand the whole thing.

4. ACKNOWLEDGMENTS

A big part of making this work possible is with the help of God, family, friends, and research advisers. God gave me the strength to carry on spiritually.

My family gave me the emotional support and financial freedom to set up my research. My research advisers Mr. Tolentino and Ms. Gadingan helped analyze my work from top to bottom.

Lastly, my friends, especially Sam Dino, helped me copy my work and convert some of the sources, and Miguel Gaddi for agreeing to collaborate on one of my tracks.

5. REFERENCES

- Danielvolffson001Danielvolffson001, Posts By, et al. "An Analysis of Christopher Nolan's Unique Style and Work." UMass Boston, 6 Feb. 2018, blogs.umb.edu/cinemastudies/2018/02/06/you-cant-forget-about-forgetting.
- Wilkinson, Alissa. "The Films of Christopher Nolan, Explained." Vox, 25 July 2017, www.vox.com/culture/2017/7/25/15985480/christopher-nolan-explained-dunkirk-inception-dark-knight.



Tribulation, The Adversities of Women in the Past and the Present: A Melodrama of Gender Inequality Parallels Between Selected Classic Plays and 21st Century Discrimination Case Studies on Women

Margaux Isabel Christine P. Chan
De La Salle University Integrated School, Manila

Abstract: With improvements in women's place in society in the 21st century, there are still manifestations of mistreatment and gender inequality. Tribulation is an artwork that cross-references 20th century plays in connection to women's experiences today. The research aims to discover the manifestations of gender inequality in classic plays and compare its realities to case studies of women experiencing similar events today. From the data gathered, it is evident that the two centuries share a parallel reality with manifestations of mistreatment towards single mothers, incidents of stalking and abduction, and poverty as a factor to enter the sex industry. The artwork is done in an interview-style performance with three characters. The researcher used this performance style to make a more personal and emotional relationship with the interviewer, who represents the audience. The performance shows explicit scenes to emphasize the physical, emotional, and mental damage of mistreatment and gender inequality.

Key Words: adversities; classic plays; gender inequality; women; 21st century

1. OVERVIEW OF THE ARTWORK

In the 21st century, there are significant efforts in feminism and gender equality. Women's status and position have advanced in the last century; however, there are still instances of this progress slowing down (Ridgeway). Women today are still significantly worse off than most of the male population (Rhode 2). Single mothers are still a part of a vulnerable population sector (Broussard et al. 191). Further, women are more likely to experience crimes like stalking and abduction (Baum 1), and women born into poverty are more likely to resort to sex work (Sanders).

Because of the growing opportunities for women in the era, 'women problems' are considered to be solved (Rhode 1). However, most people fail to see that gender barriers still exist today (Sanders 1). Although taboo, there are still instances of these topics and issues indirectly discussed in schools, institutions, and society (Yale University).

In theater, some plays in the 20th century present the reality of women in the past. Plays like *Les Miserables*, *The Phantom of the Opera*, and *Miss Saigon*. Plays were used as propaganda about revolution and mirrored the times of war. That said, theater is also often a truthful depiction of reality in a particular era or time (Szanto 4).

Although considered taboo, the three popular or 'classic' plays discusses gender inequality and discrimination. The discussion and analysis of the

three plays and their female characters mirror the reality of women today.

2. UNDERSTANDING THE ARTWORK

The problems caused by gender inequality are overlooked because of the growing opportunities for women. However, evidence states that 95% of corporate executives and 85% of elected officeholders are male, whereas two-thirds of the marginalized and the poor are female (Rhode 2). Those who fight for women's rights or try to make a difference in gender barriers are substantially low. Because of these reasons, women are still faced with the burden of gender inequality in the present era.

In 2010, more than 42% of women with early pregnancies lived in poverty because of the lack of financial assistance when raising the child as a single mother (US Census Bureau). Single mothers living in poverty usually worry about work, housing, food, insecurity, discrimination, stigma, exposure to violence, and victimization, which are all struggles that Fantine is faced with in *Les Miserables*. Single mothers are a vulnerable segment of the population, and they are the ones who easily suffer from mental and physical illnesses (Broussard et al. 191). They are the population that is usually associated with unemployment, lack of social support, domestic violence, and divorce (Turner). There are also cases that more single mothers are working part-time jobs or have lost their jobs because of discrimination and stigma (Broussard et al. 192). Forty percent of single



mothers spend more than half their money on childcare. To provide financial support for childcare, single mothers heavily rely on informal providers such as family and friends, which adds to their stress due to the pressure of being in debt (Smith; Zippay & Rangarajan).

In the 21st century, there are still cases of stalking and abduction. Stalking is defined as a pattern of repeated and unwanted intrusion by one person into the life of another. This may cause distress, disruption, or fear (Pathé & Mullen). Abduction is defined as an action of forcibly taking someone against their will (Oxford English Dictionary). Statistics about stalking incidents states that 46% of stalking victims experience at least one encounter with their stalker per week. Women are at greater risk of stalking, with 41% of victims being female (Baum 1). In 2005, there were 393 records of abduction (both false and true cases). The factors for abduction are age, gender, victim-offender relationship, physical and sexual violence, and the offender's motives. The top three motives for abduction are the following: sexual desire (35%), robbery (29%), and retribution/revenge (24%) (Fitzgerald & People). This is in connection to Christine from *The Phantom of the Opera*.

McLeod states that there is a subcultural theory that argues that economic conditions can contribute to the involvement of a woman in sex work (Sanders). Women being disadvantaged in capitalist society is central to their experiences as a prostitute. The entrance of women to the sex industry is an act of resistance to the experience of relative poverty, which can be connected to Kim's situation in *Miss Saigon*. McLeod highlighted the experiences of sex workers and their economic struggles. The interviewed sex worker said that she resorted to sex work after being fired from working at an office job for six years (Sanders).

The principal reason women enter the sex industry, particularly street-level prostitution, is poverty. Women who enter prostitution are known to be underqualified for conventional jobs. With their lack of education and desirable skills sets, these women are pushed to enter into prostitution. Despite countries having minimum wage jobs available, there are areas wherein these wages are too low to make a living. At the same time, discrimination in the higher levels of the workforce still exists, and unequal wages between the two genders, even on the same job or status, persist (Monroe 1).

3. THE ARTWORK

Tribulation revolves around three female characters. Nicole represents single mothers in poverty, Riley a stalking victim in her senior year of high school, and Meredith, an orphan and sex worker.

It focuses mainly on manifestations of gender inequality and the empowerment of women.

The play is in the form of a dramatic monologue, with three interviews, and in a proscenium stage. The set design is a gray wall. The make-up is simple and only uses foundation, face powder, and slight contour, while the costumes are casual tops. Props are not needed for the performances. A single white light bulb is used to focus on the characters in the scene, and the sounds are in the form of ambient music.

Although classic plays are very loved and have a big following, they often contribute to the normalization of gender inequality in society. The artwork serves as a tool to spread awareness of these themes in classic plays and women's problems in the 21st century. It focuses on the underlying themes of these classic plays that most people fail to recognize and discuss.

4. ACKNOWLEDGMENTS

The researcher would like to thank Mr. Carlos O. Fabio for helping with data gathering, paper revisions, and accepting to be cast as the 'interviewer' in the artwork. Most importantly, the researcher would like to thank her Practical Research adviser, Ms. Daryl Gadingan, for the guidance and support throughout the research and art creation process.

5. REFERENCES

- "Abduction." Abduction Noun - Definition, Pictures, Pronunciation and Usage Notes | Oxford Advanced Learner's Dictionary at OxfordLearnersDictionaries.com, www.oxfordlearnersdictionaries.com/us/definition/english/abduction.
- Baum, Katrina. Stalking Victimization in the United States. U.S. Dept. of Justice, Office of Justice Programs, 2008.
- Broussard, C. Anne, Alfred L. Joseph, and Marco Thompson. "Stressors and coping strategies used by single mothers living in poverty." *Affilia* 27.2 (2012): 190-204.
- Fitzgerald, J. and J. People. "Victims of Abduction: Patterns and Case Studies." *BOCSAR NSW Crime and Justice Bulletins* (2006): 16.
- Monroe, Jacquelyn. "Women in street prostitution: The result of poverty and the brunt of inequity." *Journal of poverty* 9.3 (2005): 69-88.
- Mullen, Paul E., et al. *Stalkers and Their Victims*. Cambridge University Press, 2008.
- Rhode, Deborah L. *Justice and gender: Sex discrimination and the law*. Harvard University Press, 1991.
- Ridgeway, Cecilia L. "Gender, status, and leadership." *Journal of Social issues* 57.4 (2001): 637-655.
- Sanders, Teela, et al. *Prostitution: Sex Work, Policy & Politics*. SAGE, 2018.
- Smith, Kristin. "Rural Families Choose Home-Based Child Care for Their Preschool-Aged Children. Policy Brief Number 3." Carsey Institute (2006).
- Szanto, George H. *Theater & Propaganda*. University of Texas Press, 1978.



3RD DLSU SENIOR HIGH SCHOOL RESEARCH CONGRESS

2020-2021

THEATER ARTS

Turner, Heather A. "The significance of employment for chronic stress and psychological distress among rural single mothers." *American Journal of Community Psychology* 40.3-4 (2007): 181-193.

US Census Bureau. "Annual Social and Economic Supplement (ASEC) of the CPS." The United States Census Bureau, 7 Dec. 2020, www.census.gov/programs-surveys/saipe/guidance/model-input-data/cpsasec.html.

"The Yale-New Haven Teachers Institute." Yale New Haven Teacher Institute, 1 Sept. 1987, teachersinstitute.yale.edu/curriculum/units/1987/2/87.02.10.x.html.

Zippay, Allison, and Anu Rangarajan. "Child care "packaging" among TANF recipients: Implications for social work." *Child and Adolescent Social Work Journal* 24.2 (2007): 153-172.



A Folklore Tale - Art Direction in Film: Applying Elements of Art Direction to Film Expressed as a Diorama

Allen Martin T. Lontoc

De La Salle University Integrated School, Biñan City, Laguna

Abstract: This research paper intends to show the process of creating an impactful art direction, specifically in the horror genre. Understanding the visual elements contributing to the film's overall impact is essential to create a more engaging and aesthetically pleasing art direction. The research aims to design a more artistic and complimentary art direction that would fit the film's atmosphere. The researcher developed an art direction for a Filipino horror film centering on Filipino folklore. A qualitative interview was conducted to confirm the importance of visuals in visual media. The results give more information about art direction and its conceptualization. The designs showcase a series of dioramas, featuring three different pieces, each with different settings and design philosophies. The dioramas themselves are made from several materials to create each significant element in the diorama. With this research, filmmakers in the Philippines will have a more appropriate art direction to improve their filmmaking skills.

Key Words: art direction; production design; Filipino horror film; structuralism; surrealism

1. OVERVIEW OF THE ARTWORK

The artwork's central concept is the use of sculpture as a medium to showcase the design of the art direction made for a horror film set in the Philippines. Although the artwork's primary focus is its design, it is still essential to portray this design realistically to capture the physical space's essence fully. The decision to use sculpture to show these designs was inspired by the French artist Charles Matton, who creates mixed-media models of real and imagined spaces. It was not that the artist used traditional mediums to create his artworks, but rather the emotional impact the models conveyed with a three-dimensional art form and light. With this in mind, the artwork shows the different visual elements in its design. The sculpture's primary goal is to give an accurate, realistic portrayal of how the final film should look visually.

2. UNDERSTANDING THE ARTWORK

The artwork started with designing and creating the concept art of the initial design. Designing the visuals of the film itself was created using a three-dimensional modeling program called MagicaVoxel. The concept art itself served as the primary reference of the measurements, object placements, and how each piece in the diorama should look. Each decision to add or change any visual element had to be for the benefit of the design. The texture, color palette, and props all had to revolve around the intention of this specific diorama's art direction. Each important individual piece was

sculpted with materials such as polymer clay and EVA foam. The interior walls and floorboards also used a combination of EVA foam and illustration board for another layer of durability. Other materials such as dirt, rocks, and other objects added a layer of depth into the artwork to create a more believable space.

3. THE ARTWORK

A Folklore Tale is a series of sculptures that feature three dioramas, each with a different act and setting. The dioramas use several materials such as polymer clay, illustration board, and more to create each significant piece. Since lighting plays an essential role in creating the atmosphere, the sculptures will use distinct lighting scenarios. The artwork uses color, texture, and form to enhance the environment and believability of each setting. Each diorama is displayed in its respective wooden box.

There are many considerations a production designer has to think about when conceptualizing the overall design of the film. Art direction uses visual elements such as set design, props, color, and texture. The production designer and the art department have to create a coherent design with these visual elements, which should elevate the writing and themes of the film. Every detail has to contribute to the themes of the film. Choosing these visual elements with intention will affect and contribute to the films' mood and atmosphere. Color, shape, and form affect how the film will look and the emotions the film will provoke in its viewers. The use of sculpture when creating the miniaturized physical set allowed the researcher more control over the entire design. It gave a much closer



understanding of how the film would look in a physical space. The surrealistic approach when designing the art direction gave a more distinct use of color and lighting scenarios. This approach to art direction is what the researcher hopes to see for future Filipino films.

4. ACKNOWLEDGMENTS

Thank you to my research mentors, especially my research adviser, who guided me and taught me everything I needed to know. I want to thank my girlfriend, Aimie Tanaka, especially. She supported me and inspired me to work on both the artwork and the research paper.

5. REFERENCES

- Brenner, Art. "The Structuralism of Claude Levi-Strauss and the Visual Arts." *Leonardo*, Vol 10, No. 4, 1977, pp. 303–306.
- "Chapter 1." *Art of Illusion: Production Design for Film and Television*, by Terry Ackland-Snow, The Crowood Press, 2018, pp. 28–29.
- "Diorama." *Encyclopædia Britannica*, Encyclopædia Britannica, Inc., 12 Nov. 2018, www.britannica.com/art/diorama.
- "Introduction." *Surrealism: Road to the Absolute*, by Anna Balakian, Univ. of Chicago P., 1987, pp. 14–20.
- Whitlock, C. "Part One." *The Designers: Architects of Dreams*. In *Designs on Film: A Century of Hollywood Art Direction*, ItBooks, HarperCollins, 2010, pp. 16–30.
- Ztevetevans. "The Tikbalang in Philippine Folklore: A Shapeshifting Trickster." *Under the Influence!*, 25 Apr. 2017, ztevetevans.wordpress.com/2017/04/25/the-tikbalang-in-philippine-folklore-a-shape-shifting-trickster/.



Three-Ring Circus: Images of Income Inequality and Class Conflict in the Philippines Through a Mixed Media Painting Collection

Ma. Julia Ysabel F. Galang
De La Salle University Integrated School, Manila

Abstract: Despite the Philippines' substantial strides in economic growth, the income gap remains a critical issue affecting many Filipinos. This study uses the Marxist perspective to analyze income inequality and class conflict in the Philippines. The researcher surveyed participants from different social classes and asked for their opinion about the country's access to resources, work opportunities, and law enforcement. The survey results emphasize how impactful inequality is to the everyday lives of Filipinos, from availing necessities to work opportunities. The researcher produced a creative output that amplifies the voices of the oppressed and fosters experimentation through mixed media. Works of surrealism inspired the three-part painting collection. Viewers can reflect on or interpret the paintings' meanings by themselves. Acrylics were applied in thick, precise coats, creating an embossed look to emphasize the subjects. With these techniques, the paintings have a more significant impact on the audience and serve as instruments that could initiate discourse.

Key Words: class conflict; income inequality; Marxism; surrealism; mixed media

1. OVERVIEW OF THE ARTWORK

The artwork features a perplexing scene that presents current issues under social stratification in the Philippines, particularly about class conflict and income inequality. As stated by Turner, stratification is present when "individuals can be ranked along a scale according to a criterion or a set of criteria" (23). Accordingly, the social structure to be observed in the artwork will consist of the lower class, the middle class, and the upper class.

Despite the Philippines' substantial strides in economic growth, the income gap remains a critical issue affecting many Filipinos. Hence, the researcher produced a creative output that amplifies the voices of the oppressed and fosters experimentation through mixed media. By showing the disparity between social classes, the viewers think of solutions. Numerous works use Marxism to criticize society's injustices. However, a lack of action to resolve them simply means that this issue still needs a more powerful voice and be given a great deal of attention. If many individuals were to speak up about the country's current situation, the government and leaders would hear and reach out to their citizens.

The artwork is a collection of three mixed media paintings featuring different narratives about income inequality and class conflict in the Philippines. The central painting depicts the income inequality or gap between the upper, middle, and lower classes. The other two paintings feature the conflict between social classes, with the upper and lower classes as the focal point. One focuses on the lower class's struggles, while the other presents the dominance of the upper class.

The paintings are inspired by the surrealist style, which seeks to convey the subconscious mind's workings and is composed of real-life elements that usually appear illogical at first. Simply put, surrealist artworks are a product of fantasy and reality. In comparison to receiving the message directly, viewers can reflect on or interpret the paintings' meanings by themselves. Through the chosen art style, the paintings have a more significant impact on the audience.

There is also a hint of realistic representation in terms of technique, but the images themselves are made with the influence of surrealism only. Consequently, oil paints are used as a medium to achieve a realistic look through blending and glazing easily. Mixed media comes in the form of slightly heavier loads of acrylic paint, which adds texture and dimension to the main elements of the painting. Aside from its use in achieving the embossed look, acrylic paints are also utilized for underpainting, which means that multiple layers of oil paint are added on top to increase opacity and add finishing touches.

2. UNDERSTANDING THE ARTWORK

2.1 *Marxism*

Jae Emerling's *Theory of Art History* presents the different critical theories within art history, including Marxism. As noted by Emerling, Marxism is based on the ideas proposed by Karl Marx and Friedrich Engels as a criticism of industrial capitalism (16). In light of what Marx saw as the inequality and



deprivation created by industrial capitalism in the nineteenth century, he was personally concerned with the need for social change. He argues that this system eventually results in the development of class inequality. The proletariat, workers who sell their labor for a wage, are forced to let capitalists, who own and manage production, make a profit at the expense of the workers. People who belong to the third class, the bourgeoisie, are usually classified as capitalists even though they provide services to both. According to San Juan, the Marxist critique of capitalism encourages people to reevaluate what's wrong with the world—why there are tremendous wealth and income inequality at a time when neoliberals keep prattling about macroeconomic prosperity and growing wealth for the wealthiest—and how the world can be improved (10).

2.2 Income Inequality and Class Conflict

Kusaka noted that the Philippines' social system is characterized by severe class disparities and a high poverty rate, and these have had a powerful effect on democratic practice (21-22). According to data sourced from the 2015 Family Income and Expenditure Survey (FIES) by the Philippine Statistics Authority (PSA), the majority (58.4%) of Filipinos belong to the lower class, around 40% of the population belong to the middle class, and only 1.4% fall in the upper class (Albert et al. 2). Moreover, the latest FIES states that the Philippines' Gini coefficient in 2018 is estimated at 0.4267 (Maps). The Gini coefficient is used to measure the income inequality among families, with 0 indicating perfect equality and 1 indicating absolute inequality—in this case, the country's Gini coefficient translates to a significant income gap.

2.3 Survey

The researcher surveyed participants from different social classes. Besides gathering data about the participants' background information, the researcher asked for their opinion on the country's access to resources, work opportunities, and law enforcement.

Based on the gathered data from participants, Filipinos are aware of the injustices and mistreatment transpiring in the country's justice system. Law enforcement in the Philippines may not be seen as fair and just by its citizens.

The survey outcomes emphasize how much impact the issue of inequality brings to the everyday lives of Filipinos, from availing necessities to work opportunities. Based on the participants' insights, those who belong at the top of the social structure—such as politicians—may use their power to pull strings and widen the gap between the rich and the poor.

2.4 Methods and Techniques

The artist used various techniques for the improvement of workflow and appearance. Before illustrating, a grid was sketched onto the canvas to replicate the planned images made on paper and ensure cohesiveness and balance between all the paintings. The artist also worked from the largest to the smallest areas for each layer of paint. The background and sub-elements of each painting were done first before the main subjects. Moreover, the background colors appear duller and washed out, following the principle of atmospheric perspective.

The artist's unique method is applying acrylic paint with high volume to create thickness and depth to the paintings' main subjects. This highlights the said elements and adds texture, making them look embossed and 3D-like. The thick paint was also applied so that every edge or line would be visible, and the artist could track where to put shadows and other features for the remaining layers of paint, even when they get covered up.

2.5 Surrealism as an Art Style

The style of painting is adapted from surrealist works. As noted by Spiteri and LaCoss, Herbert Marcuse expressed that the efforts of surrealism used to show that forces are operating in the world with which we refuse to come to grips. It offers more than a simple broadening of our comprehension, imagination, and reason; it is also a project to reform society's structures and requirements. This creative output aims to show precisely that. Aside from challenging people's minds, one of the artwork's objectives is to be an instrument that would start a discussion about the country's inequalities and hopefully reach the right people that could lend a hand to or contribute to solving them.

3. THE ARTWORK

Three-Ring Circus is a triptych artwork—all of which take place in the wilderness—with similar color palettes and elements. All images share the same sky to indicate the same society, but the variations of grass signify the difference in experiences and resources. Additionally, all creatures possess a human body to hint that they are representations of humans. To highlight these main subjects, they are embossed with acrylic paint.

3.1 Scavenger

Scavenger presents the lower classes' lack of means to avail necessities due to low income. They are forced to be resourceful to survive. This is especially apparent when the pandemic has caused panic buying, leaving little to no resources for others. Other



limitations include lack of education and the scarcity of productive job opportunities.

A coyote is generally known as a scavenger, an animal that feeds on carrion, dead plant material, or refuse. This painting represents the lower class and their struggle to avail themselves of their needs. The chopped trees, branches, and bones collectively represent the lack of resources. Lastly, the faint view of trees and mountains hints at the large gap between them and the upper class.

3.2 *Horsepower*

Horsepower presents the rising gap between different social classes in the country. It signifies the working class' exploitation, receiving low wages for their labor and causing higher inequalities.

On the one hand, pigs are often viewed as laid-back animals and are used to symbolize laziness and greed. The pig in the image does not represent the whole upper-class population but those who abuse their power for profit over social good. On the other hand, horses are known as "working animals" trained to perform specific tasks. They represent the middle and lower classes, wherein those at the bottom receive fewer and fewer resources as indicated by the meat above and the bones below.

3.3 *Overdog*

Overdog presents how power and connections run strongly in today's society. High-profile and wealthy individuals can get away with anything, including crimes, which is why injustice prevails in the system.

The pig in the image shares the exact representation with the one in *Horsepower*. Meanwhile, the dog signifies the people in the government or the justice system who allow mistreatment and inequities. They are also attracted to treats—or rewards, for those that they represent.

4. ACKNOWLEDGMENTS

The researcher, first and foremost, thanks the Lord God, the Source of all Wisdom and Fountain of all Goodness, for His guidance from the beginning to the completion of this humble undertaking.

The researcher extends her most heartfelt gratitude to:

Ms. Ellemay Kimberly S. Dumalaog, for sharing her time and expertise as the research adviser and generously assisting the researcher in proofreading, preparing materials, and painting techniques.

The friends of the researcher, for their constant understanding, unwavering support, and being a source of motivation; and

The family of the researcher, for their continuous feedback, financial support, and words of encouragement.

5. REFERENCES

- Emerling, Jae. *Theory for Art History: Adapted from Theory for Religious Studies*, by William E. Deal and Timothy K. Beal. Routledge, 2019.
- Juan, David Michael M. San. "Why Marx was right: Third world edition." *Journal of Developing Societies*, vol 33, no. 1, 2017, pp. 1-26.
- Kusaka, Wataru. *Moral politics in the Philippines: Inequality, democracy, and the urban poor*. NUS Press, 2017.
- Maps, Claire Dennis S. *Annual Family Income is Estimated at PhP 313 Thousand, on Average, In 2018*. Philippine Statistics Authority, Philippines, Dec. 2019, psa.gov.ph/content/annual-family-income-estimated-php-313-thousand-average-2018#:~:text=The%20Gini%20coefficient%20of%20the,estimated%20at%200.4267%20in%202018.&text=The%20Gini%20coefficient%20is%20a,1%20indicating%20absolute%20income%20inequality.
- Spiteri, Raymond, and Donald LaCoss. *Surrealism, politics, and culture*. Routledge, 2020.
- Stockwell, Peter. *The language of surrealism*. Macmillan International Higher Education, 2016.
- Tuaño, Philip Arnold, and Jerik Cruz. "Structural Inequality in the Philippines: Oligarchy, (Im)Mobility and Economic Transformation." *Journal of Southeast Asian Economies*, vol. 36, no. 3, 2019, pp. 304–328. JSTOR, www.jstor.org/stable/26842378.
- Turner, Mark Macdonald. "Inequality in the Philippines: Old Bottlenecks and New Directions for Analysis." *Philippine Sociological Review*, vol. 30, no. 1/4, 1982, pp. 23–32. JSTOR, www.jstor.org/stable/23898093.

THE 3RD DLSU SHS RESEARCH CONGRESS COMMITTEE

Mr. Rembrandt P. Santos
Congress Director

Mr. Christian P. Gopez
Events Chair

Ms. Myrla D. Torres
Research Congress Chair

Mr. Christian M. Lacza
Communications Head

Ms. Liezl R. Astudillo
Paper Presentation Head

Ms. Sherilyn T. Abarra
Registration Head

Ms. Whenn G. Pena
Poster Presentation Head

Ms. Shiela Rose E. Salvador
Finance Head

Mr. Reymund R. Gonowon
Business Concept Bazaar Head

Ms. Daryl D. Gadingan
Program Head

Mr. Engelbert C. Talunton
Art Performances and Exhibitions Head

Mr. Jairus A. Fernando
Creatives Head

Mr. Leo Vicentino
Teacher Training Head

Ms. Loisel R. Gervacio
Sponsorship Head

Ms. Candice Marie V. Perez
Publications Head

THE 3RD DLSU SHS RESEARCH CONGRESS PROCEEDINGS PUBLICATIONS COMMITTEE

Ms. Candice Marie V. Perez
Publications Head

Ms. Romina Gracia C. Cortez
Copy Editor

Ms. April Rose C. Gonzales
Copy Editor

Ms. Jaimee Anne M. Esteban
Copy Editor

3RD DLSU SENIOR HIGH SCHOOL

RESEARCH CONGRESS

REFRAMING POSSIBILITIES THROUGH
RESEARCH AND INNOVATION
FOR THE BETTER NORMAL

APRIL 29 - 30, 2021